

**EAST ROSEMARY STREET
TOWN PARKING DECK & OFFICE BUILDING
REDEVELOPMENTS**

TRANSPORTATION IMPACT ANALYSIS



Prepared for:

The Town of Chapel Hill
Public Works Department - Engineering

Prepared by:

HNTB North Carolina, PC

*343 East Six Forks Road
Suite 200
Raleigh, NC 27609*

NCBELS License #: C-1554

September 2020



EAST ROSEMARY STREET

**TOWN PARKING DECK & OFFICE BUILDING
REDEVELOPMENTS**

TRANSPORTATION IMPACT ANALYSIS



Prepared for:

The Town of Chapel Hill
Public Works Department - Engineering

Prepared by:

HNTB North Carolina, PC

*343 East Six Forks Road
Suite 200
Raleigh, NC 27609*

NCBELS License #: C-1554

September 2020

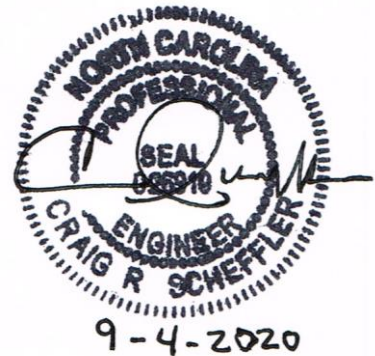



Table of Contents

	<u>Page</u>
LIST OF FIGURES	ii
LIST OF TABLES/APPENDICES	ii
I. Existing Conditions.....	1
A. Project Overview	1
B. Site Location and Study Area	1
C. Site Descriptions	2
D. Existing and Proposed Uses in Vicinity of Sites	3
E. Existing and Committed Surface Transportation Network	3
F. Existing Traffic Conditions	7
II. Future Build-Out Year+1 Conditions	7
A. Future Ambient Area-Wide Traffic Growth Estimation	7
B. Approved Background Development Traffic Estimation	9
C. Proposed Project Traffic	9
i.) Trip Generation	9
ii.) Adjustments to Trip Generation Rates	11
iii.) Trip Distribution	12
iv.) Trip Assignment	13
D. Future Traffic Forecasts with the Proposed Redevelopment Projects	14
III. Impact Analyses	14
A. Peak Hour Intersection Level-of-Service Analysis	14
i.) Methodology	14
ii.) 2020 Existing Conditions Results	16
iii.) 2022 No-Build Parking Deck Scenario (Condition 2) Results	16
iv.) 2022 Build Parking Deck Scenario (Condition 3) Results	17
v.) 2022 Build Scenario With North Street Access (Condition 4) Results	21
vi.) 2023 No-Build Office Building Scenario (Condition 5) Results	22
vii.) 2023 Build Office Building Scenario (Condition 6) Results	22
viii.) 2023 Build Scenario With Recommended Office Parking Access (Condition 7) Results	25
B. Access Analysis	26
C. Signal Warrant Analysis	27
D. Sight Distance Analysis	27
E. Crash Analysis	28
F. Other Transportation-Related Analyses	29
G. Special Analysis/Issues Related to the Project	29
IV. Mitigation Measures/Recommendations	31
A. Planned Improvements	31
B. Background Committed Improvements	31
C. Applicant Committed Improvements	31
D. Necessary Improvements	31



List of Figures

Figure

- 1) Project Study Area
- 2A-2B) Preliminary Site Concept Plans
- 3-3A) Existing Laneage & Geometrics
- 4) Study Area Pedestrian & Bicycle Facilities
- 5-5A) 2020 Existing Peak Hour Traffic Volumes
- 6) Background Development Locations
- 7-7A) 2022 Peak Hour Traffic Volumes Without Parking Deck
- 8-8B) 2022 Parking Deck Site Trip Distribution Percentages
- 9-9A) 2023 Office Building Site Trip Distribution Percentages
- 10-10B) 2022 Parking Deck Peak Hour Site Traffic Assignment
- 11-11A) 2023 Office Building Site Traffic Assignment
- 12-12B) 2022 Peak Hour Traffic Volumes With Parking Deck
- 13-13A) 2023 Peak Hour Traffic Volumes with Parking Deck and Office Building
- 14) 2022 LOS Summary
- 15) 2023 LOS Summary
- 16) Planned, Committed and Recommended Improvements
- 16A) Recommended Improvements Inset

List of Tables

Table	<u>Page</u>
1) Existing Study Area Roadways	4
2) Existing Study Area Intersection Details	5
3) Traffic Count Information	8
4) Existing Parking Occupancy Data	9
5) Weekday Vehicle Trip Generation Summary – Parking Deck	11
6) Weekday Vehicle Trip Generation Summary – Office Building	11
7) Office Building Trip Assignment Proportions	13
8) Level of Service (LOS) Characteristics	15
9) Capacity Analysis Results - Condition 1 – 2020 Existing Traffic	18
10) Capacity Analysis Results - Condition 2 – 2022 Traffic Without Proposed Parking Deck.....	19
11) Capacity Analysis Results - Condition 3 – 2022 Traffic With Site (Rosemary-Only Access) ...	20
12) Capacity Analysis Results - Condition 4 – 2022 Traffic With Site (North Street Access)	21
13) Capacity Analysis Results - Condition 5 – 2023 Traffic Without Office Building	23
14) Capacity Analysis Results - Condition 6 – 2023 Traffic With Office Building	24-25
15) Capacity Analysis Results - Condition 7 – 2023 Traffic (Modified Office Building Access)	26
16) Study Area Crash Rate Comparison – E. Rosemary Street Corridor	28
17) Study Area Crash Rate Comparison – NC 86 Corridor	29
18) Study Area Intersection Crash Summary	29
19) Other Transportation-Related Analyses	30

Appendices

- | | |
|---|--|
| A. Figures | F. 2023 PM Peak Hour – With Site and North Street Access SimTraffic Queueing and Blocking Report |
| B. Traffic Count Data | G. Peak Hour Signal Warrant Analysis |
| C. Scenario Volume Development Spreadsheet Output | H. Crash Data |
| D. Synchro Signalized Analysis Output | |
| E. Synchro Unsignalized HCM Analysis Output | |



I. EXISTING CONDITIONS

A. Project Overview

A new office building and parking deck are being proposed as a combined redevelopment project along E. Rosemary Street, just east of its intersection with NC 86 (N. Columbia Street) in Chapel Hill, NC. Based on Transportation Impact Analysis (TIA) scoping discussions with Town of Chapel Hill staff and the Applicant, there will be two separate traffic impact studies conducted for this project. This report contains the initial study of the impacts of the proposed 1,100 space parking deck (completed in March 2020), as well as the second phase of the overall project – the redevelopment of the current Town-owned Wallace Parking Deck with a 200,000 square foot office building and 200 on-site parking spaces. **Figure 1** (found in **Appendix A**) shows the general location of the two sites.

The project is anticipated to be completed in two stages – with the new Parking Deck constructed by 2021 and the office building by 2022. This report analyzes the full build-out scenario for the year 2022 (one year after full build-out of the new parking deck), the year 2023 (one year after full build-out of the new office building), the no-build scenarios for 2022 and 2023, as well as 2020 existing year traffic conditions. The no-build scenario for the 2023 analysis year includes the build-out and utilization of the parking deck.

The proposed parking deck site concept plan shows a provision for two full movement access driveways that connect the new parking deck to E. Rosemary Street. Additionally, the concept plan displays a potential parking deck access point onto NC 86 (N. Columbia Street). Additional access could be accommodated along North Street and consideration for this was also included in this study. **Figures 2A and 2B**, respectively, display the initial preliminary concept plans for the new Rosemary Parking Deck and office building and nearby land uses and roadways.

B. Site Location and Study Area

This report analyzes and presents the transportation impacts that the new E. Rosemary Street parking deck and office building projects will have on the following intersections in the project study area:

- W. Rosemary Street and Church Street
- W. Rosemary Street and NC 86 (N. Columbia Street)
- E. Rosemary Street and Henderson Street
- E. Rosemary Street and Hillsborough Street
- SR 1010 (W. Franklin Street) and Church Street
- SR 1010 (Franklin Street) and NC 86 (Columbia Street)
- SR 1010 (E. Franklin Street) and Henderson Street
- SR 1010 (E. Franklin Street) and Hillsborough Street / Raleigh Street
- NC 86 (N. Columbia Street / MLK Jr. Boulevard) and N. Columbia Street / North Street
- NC 86 (MLK Jr. Boulevard) and Longview Street / Mill Creek Condominiums
- W. Cameron Avenue and NC 86 SB (Pittsboro Street)
- Cameron Avenue and NC 86 (S. Columbia Street)
- E. Cameron Avenue / Country Club Road and Raleigh Street

In addition to these existing intersections, several existing and future driveway access points to/from the existing parking facilities and proposed parking deck and office building will be studied. They include the following:



- E. Rosemary Street and Rosemary Parking Deck Access
- E. Rosemary Street and Private Surface Lot Access
- E. Rosemary Street and West Alley Entrance / West Deck Exit (Wallace Deck Entrance / Exit 1)
- E. Rosemary Street and Wallace Deck East Exit / East Alley Full Access (Wallace Deck Entrance / Exit 2)
- North Street and New E. Rosemary Deck Potential Connection
- E. Rosemary Street and New E. Rosemary Deck Proposed Main Entrances / Exits
- E. Rosemary Street and New Office Building Proposed Underground Deck Access Points – exact locations currently under development – assuming two access points along E. Rosemary Street initially for the purposes of this study.

The impacts of the proposed site at the study area intersections will be evaluated during the AM, noon, and PM peak hours of an average weekday. The following study is based on background traffic for the existing year, 2020, the years following the estimated site build-out dates (2022 and 2023), as well as the estimated site-generated traffic produced by the proposed parking deck (which will be considered a “net” impact, as the construction of the deck includes the demolition of the current Rosemary Deck, adjacent private surface lot and Columbia/Rosemary Surface Parking Lot #2. It also assumes that in the 2022 build-out year, the Wallace Deck will be demolished to allow future construction of the proposed office building.

There is one Town-approved development in the project study area, Union Chapel Hill Apartments, currently under construction and scheduled to open in fall 2020 that will generate additional background traffic. To account for on-going planned growth beyond the immediate project study area, and in consideration the most of the immediately project study area is already nearly built-out, an area-wide ambient future traffic growth percentage of 1.0 percent per year was applied to the existing traffic volumes, which also includes a review of historical average annual daily traffic (AADT) growth rate data provided by the Town of Chapel Hill and NCDOT.

C. Site Descriptions

The proposed parking deck site is currently the location of the Town’s Rosemary Parking Deck with three levels and 285 spaces as well as a private surface parking lot with 109 spaces. Access is only provided in one location along E. Rosemary Street to the existing parking deck and to the private parking lot. The deck borders PNC Bank property to the west and several commercial businesses and additional parking lots to the east (serving the BB&T, Rosemary East and former Bub O’Malley’s buildings). To the north, it borders the North Street residential neighborhood and commercial office development along NC 86 (N. Columbia Street). The rest of the project study area encompasses a large portion of downtown Chapel Hill and parts of UNC’s Main Campus. It is an urban environment with higher density commercial, residential and institutional development mixed with several historic residential neighborhoods.



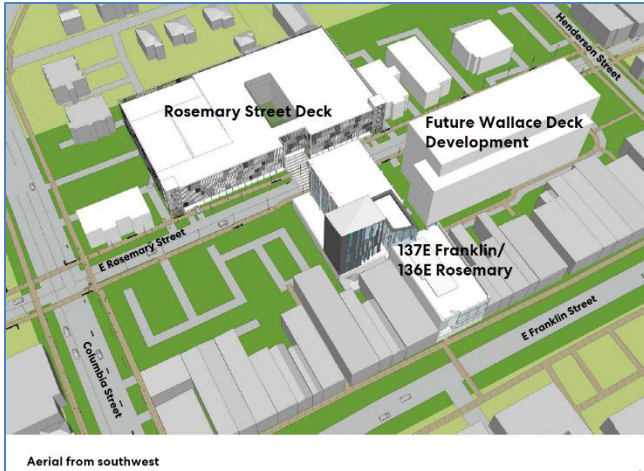

The proposed parking deck’s frontage along E. Rosemary Street which provide all vehicular access at two full movement entrance/exits in the initial build-out scenario. The exits as shown conceptually in **Figure 2A**, are located approximately 250 feet apart at either end of the deck structure, with the western access point located approximately 300 feet from NC 86 (N. Columbia Street). Additional access points with NC 86 and North Street were also considered in this study.

The proposed office building will redevelop the current Town-owned Wallace Parking Deck on approximately the same 1.6 acre footprint of the parking deck. The building will be designed for

six stories, with two levels of underground parking. No formal design of driveway access has been completed prior to this study, so several assumptions were made and shown in **Figure 2B**.

D. Existing and Proposed Uses in Vicinity of the Sites

The land uses and development in the study area form a large portion of the core of downtown Chapel Hill and are primarily medium to high density commercial, residential and institutional. The Existing Land Use Plan shown in the *2020 Town of Chapel Hill Comprehensive Plan* and adopted September 25, 2012, indicates that the proposed sites are currently designated as “Town/Village Center”. The Future Land Use Plan, that is also a part of the Town Comprehensive Plan, indicates that the parcel would continue in “Town/Village Center” designation, as well as be part of a “Downtown Future Focus Discussion Area”. The parcels are currently zoned “TC-2” – delineating each as “Town Center-2”.

E. Existing and Committed Surface Transportation Network

Roadways

The E. Rosemary Street Parking Deck and Office Building project study area includes a large portion of Downtown Chapel Hill and features several principal arterials, minor arterials, and collector/local roads serving areas throughout Downtown Chapel Hill and points beyond. **Table 1** summarizes pertinent information on the study area roadway facilities. AADT data was taken from 2017 AADT mapping produced by the NCDOT Traffic Survey Unit (most recently published data available). **Figures 3 and 3A** show the existing lane configuration, traffic control, and speed limits for these study area roadways. Detailed descriptions of several of the major study area roadways are as follows:

- **NC 86 (Columbia Street / MLK Jr. Boulevard)** is a principal arterial in the study area, serving areas from I-40 (via Martin Luther King Jr. Boulevard) to downtown Chapel Hill. In the study vicinity, NC 86 (Columbia Street / MLK Jr. Boulevard) varies from a four-lane undivided cross-section to a five-lane roadway with center two-way left-turn lane, with left-turn and right-turn lanes at select intersections. There are a few driveway access points along the roadway and several major street intersections. On-street parking is permitted in some designated areas along Columbia Street. Several bus stops are located along the facility. The posted speed limit is 35 mph in the study area north of Rosemary Street and drops to 25 mph through the downtown and UNC Main Campus area.
- **NC 86 Northbound (S. Columbia Street)** becomes a northbound one-way street south of Cameron Avenue. It is a principal arterial in the study area with a three-lane undivided cross-section. On-street parking is not permitted in the study area and the posted speed limit is 25 mph.



Table 1. Existing Study Area Roadways

Road Name	Functional Classification*	Study Area Cross-Section	2017 AADT	Speed Limit	Sidewalk	On-Street Parking
NC 86 (MLK Jr. Boulevard)	Principal Arterial	5-lane undivided with TWLTL	19,000	35	Y	N
NC 86 (Columbia Street)	Principal Arterial	4- to 5-lane undivided	15,000	25 / 35	Y	S
NC 86 (Columbia Street) Northbound One-Way Street	Principal Arterial	3-lane undivided	9,300	25	Y	N
NC 86 (Pittsboro Street)	Principal Arterial	2-lane undivided	8,500	25	Y	N
SR 1010 (E. Franklin Street)	Principal Arterial	4-lane undivided	14,000	20	Y	Y
SR 1010 (W. Franklin Street)	Minor Arterial	5-lane undivided with TWLTL	13,000	20	Y	S
E. Rosemary Street	Local	2- to 3-lane undivided	N/A	20	Y	N
W. Rosemary Street	Local	2-lane undivided	N/A	20	Y	N
E. Longview Street	Local	2-lane undivided	N/A	25	S	N
N. Columbia Street	Local	2-lane undivided	N/A	25 / 35	S	N
North Street	Local	2-lane undivided	N/A	20	S	N
Church Street	Local	2-lane undivided	N/A	25	Y	N
W. Cameron Avenue	Local	2-lane undivided	7,100	25	Y	S
NC 86 (W. Cameron Ave)	Principal Arterial	4-lane undivided	13,000	25	Y	N
E. Cameron Avenue	Local	2-lane undivided	N/A	25	Y	N
Henderson Street	Local	2-lane undivided	N/A	25	Y	Y
Hillsborough Street	Local	2-lane undivided	8,100 ^S	25	S	N
Raleigh Street	Local	2-lane undivided	4,800	25	S	S
Country Club Road	Local	2-lane undivided	12,000	25	Y	S

S – Some Sidewalk/Parking Present TWLTL – Two-Way Left-turn Lane \$ - 2015 AADT Data

* - As defined on the NCDOT Functional Classification web page <http://ncdot.maps.arcgis.com/home/webmap/viewer.html>

- **NC 86 Southbound (Pittsboro Street)** is a southbound one-way street south of Cameron Avenue. It is a principal arterial in the study area with a two-lane undivided cross-section. On-street parking is not permitted in the study area and the posted speed limit is 25 mph.
- **SR 1010 (Franklin Street)** is an arterial (E. Franklin Street is a principal arterial and W. Franklin Street is a minor arterial) in the study area, serving areas from downtown Chapel Hill to downtown Carrboro. In the study area vicinity, Franklin Street varies from a five-lane roadway with center two-way left-turn lane west of NC 86 (Columbia Street) to a four-lane undivided cross-section east of NC 86 (Columbia Street) with left-turn storage bays at select intersections. There are numerous driveway access points along the roadway and several minor street intersections. On-street parking is permitted in some designated areas along Franklin Street. Several bus stops are located along the facility in the study area vicinity. The posted speed limit is 20 mph in the project vicinity.
- **Rosemary Street** is designated a local street by NCDOT in the study area, serving areas from downtown Chapel Hill to downtown Carrboro. In the study area vicinity, Rosemary Street varies between a two-lane and a three-lane roadway. There are numerous driveway access points along the roadway and several minor street intersections. On-street parking is permitted in some designated areas along Rosemary Street. Several bus stops are located along the facility. The posted speed limit is 20 mph in the project study area.
- **Cameron Avenue** is predominantly a local street (as designated by NCDOT) in the study area and serves areas that include east Chapel Hill, the UNC campus, and southeast Carrboro. For a brief



stretch from NC 86 (Pittsboro Street) to NC 86 (S. Columbia Street), Cameron Avenue is designated NC 86, is a principal arterial, and has a four-lane undivided cross-section. Otherwise, Cameron Avenue is a two-lane in the study area. There are numerous cross walks along the E. Cameron Avenue that provide pedestrian access for the UNC campus and on-street parking is permitted at some designated areas. The posted speed limit is 25 mph in the project study area.

- The other study area public roadways are two-lane undivided local access facilities with 25 or 35 mph posted speed limits. Most feature sidewalks on at least one side of the roadway.

Intersections

Table 2 summarizes all major existing study area intersections, traffic control features, and pedestrian amenities at each. Laneage details and intersection turn bay lengths are also detailed on **Figures 3 and 3A**. The project study area in Downtown Chapel Hill features a mixture of signalized and unsignalized intersections, with many of the signalized intersections in the downtown area included in this study. The Rosemary Street, SR 1010 (Franklin Street), NC 86 (Columbia Street / MLK Jr. Boulevard), and Cameron Avenue corridors feature coordinated signal operation at most signals for weekday peak hours.



Table 2. Existing Study Area Intersection Details

Intersection	Traffic Control	Signal Phases	Signal Operation	Cross walk	Ped Signals
W. Rosemary Street and Church Street	Signal	2	Coordinated	Yes (4)	Yes (4)
W. Rosemary Street and NC 86 (N. Columbia Street)	Signal	6	Coordinated	Yes (4)	Yes (4)
E. Rosemary Street and Henderson Street	Signal	2	Coordinated	Yes (4)	Yes (4)
E. Rosemary Street and Hillsborough Street	Signal	3	Coordinated	Yes (4)	Yes (4)
W. Franklin Street and Church Street	Signal	2	Coordinated	Yes (4)	Yes (4)
Franklin Street and NC 86 (Columbia Street)	Signal	8	Coordinated	Yes (4)	Yes (4)
E. Franklin Street and Henderson Street	Signal	2	Coordinated	Yes (3)	Yes (3)
E. Franklin Street and Hillsborough St. / Raleigh Street	Signal	3	Coordinated	Yes (4)	Yes (4)
NC 86 (MLK Jr. Blvd) and N. Columbia St. / North St	TWSC	N/A	N/A	No	No
NC 86 (MLK Jr. Boulevard) and Longview Street	Signal	2	Free-Run	Yes (3)	Yes (3)
W. Cameron Avenue and NC 86 SB (Pittsboro Street)	Signal	3	Coordinated	Yes (2)	Yes (2)
Cameron Avenue and NC 86 (S. Columbia Street)	Signal	4*	Coordinated	Yes (4)	Yes (4)
E. Cameron Ave. / Country Club Rd and Raleigh Street	Signal	6	Free-Run	Yes (4)	Yes (4)

TWSC = Two-Way Stop Controlled Intersection * - The 4th phase is an all-pedestrian phase

Bicycle Routes and Sidewalks

Specific bicycle facilities are present within the study area, with striped bicycle lanes on W. Rosemary Street west of NC 86 (N. Columbia Street), on W. Cameron Avenue west of NC 86 Southbound (Pittsboro Street), and on NC 86 Southbound (Pittsboro Street) south of W. Cameron Avenue. No other exclusive-use bicycle facilities are currently present, though several roadways have painted “sharrows” to delineate space for bicycling. Pedestrian sidewalks are found on both sides of the road on the major Rosemary Street, SR 1010 (Franklin Street), NC 86 (Columbia Street / MLK Jr. Boulevard), and Cameron Avenue



Town of Chapel Hill: Transportation Impact Analysis

East Rosemary Street - Proposed Town Parking Deck & Office Building Redevelopments

corridors and along at least one side of every road throughout the study area. Crosswalks and pedestrian signals are present at all 12 signalized intersections in the study area, with additional unsignalized crosswalks at many locations throughout the study area. There is currently an “over street” walkway bridge that connects the existing Rosemary parking deck to the office building on the other side of E. Rosemary Street. **Figure 4** displays a schematic of existing pedestrian and bicycle facilities in the project study area.

Transit Routes

Various Chapel Hill Transit (CHT) routes currently serve the study area in Downtown Chapel Hill with weekday bus service and Saturday service. Numerous bus stops, with a range of amenities (shelters, benches, bus pull-outs), are present in the study area. **Exhibit 1** details the current CHT routes serving the downtown Chapel Hill and the study area.

The potential for transit trips related to the parking deck land use is low and compared to other development projects, the evaluation of transit impacts for the parking deck is limited. Transit usage for the proposed office building is expected to have an effect on reducing vehicular trips for this land use. As shown on the Exhibit on the following page, access and connectivity from the deck and office building to transit options serving all areas of Chapel Hill is currently very good.

Exhibit 1. Current Study Area Weekday Transit Service

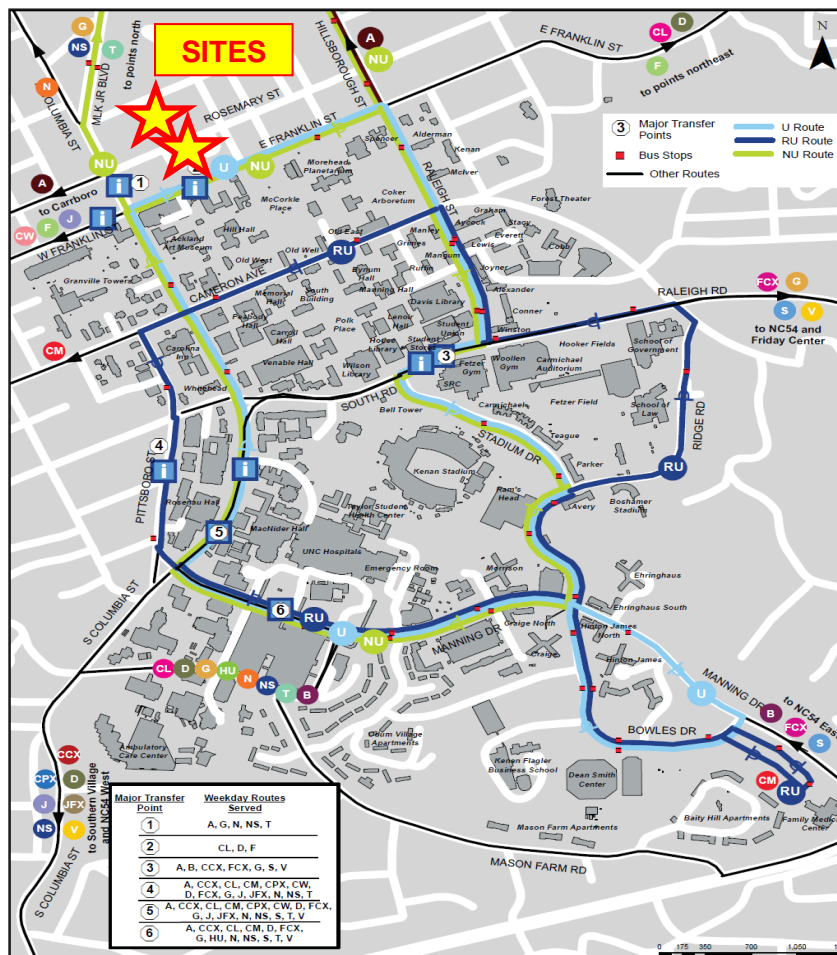

Source: CHT 2019 Fall Ride Guide



Recommended/Committed Surface Transportation Improvement Projects

There are no committed/programmed NCDOT State Transportation Improvement Program (STIP) projects in the project study area included in the most recent 2020 – 2029 STIP. There is one Town of Chapel Hill transportation-related project in the project study area expected to be complete by 2023 – the West Franklin Lane Reallocation that will eliminate a through travel lane in each direction from Merritt Mill Road to NC 86 (Columbia Street). The reallocation will improve facilities for pedestrian, bicycle, transit, and commercial vehicle loading zones. There are no private development-related projects to improve roadway facilities in the study area that are expected to be complete by 2023.

F. Existing Traffic Conditions

Figures 5 and 5A show the existing AM, noon, and PM peak hour traffic volumes for the study area intersections. The counts used to determine these volumes were conducted in January and February 2020 for all study area intersections during the weekday periods 7:00 - 9:00 AM, 11:30 AM – 1:30 PM, and 4:00 – 6:00 PM. This data, along with all turning movement count output is found in **Appendix B. Table 3** provides a detailed listing of each intersection count, peak hour, and count date.

Traffic count information in **Figures 5 and 5A** shows traffic flows inbound to the downtown Chapel Hill and UNC Main Campus area were relatively heavy during the AM peak count period. Activity was also relatively high during the noon peak hour, with generally equal traffic directional distributions throughout the downtown network on higher volume arterial roadway facilities. Highest overall traffic volumes in the project study area were generally in the PM peak hour. Traffic on E. Rosemary Street adjacent to the project site was moderate during the peak commuting periods, with a considerable proportion of the overall traffic flow on this block originating or terminating at the existing parking facilities. Traffic flows were light to moderate on the remaining study area roadways that function as collector or local streets.

II. FUTURE BUILD-OUT YEAR+1 CONDITIONS

A. Future Ambient Area-Wide Traffic Growth Estimation

Based on information on average daily traffic collected by the Town of Chapel Hill and the NCDOT, a yearly ambient traffic growth rate of 1.0 percent per year was used for both the short-term 2022 and 2023 design year capacity analyses. This rate is based on previous and anticipated growth trends for this area from Town and NCDOT average daily traffic information from the period 2003-2017 and is generally consistent with recent traffic impact studies near the project study area. Historic traffic volumes for project study area roadways do not present much growth over the last 15 years. However, as described in the following section, anticipated traffic volume growth from development projects outside the immediate project study area may lead to growth on study area roadways over the next several years, which is accounted for in the conservative 1.0 percent per year ambient growth rate.



Table 3. Traffic Count Information

Count Location	Period Counted	Peak Hour	Date of Count
W. Rosemary Street & Church Street	AM Peak	8:00 – 9:00 AM	2/25/20
	Noon Peak	12:00 – 1:00 PM	
	PM Peak	5:00 – 6:00 PM	2/19/20
W. Rosemary Street & NC 86 (N. Columbia St)	AM Peak	7:45 – 8:45 AM	2/25/20
	Noon Peak	12:00 – 1:00 PM	
	PM Peak	5:00 – 6:00 PM	2/19/20
E. Rosemary Street & Rosemary Parking Deck	AM Peak	8:00 – 9:00 AM	2/25/20
	Noon Peak	11:45 AM–12:45 PM	
	PM Peak	4:45 – 5:45 PM	2/19/20
E. Rosemary Street & Surface Lot	AM Peak	7:30 – 8:30 AM	2/25/20
	Noon Peak	12:15 – 1:15 PM	
	PM Peak	4:30 – 5:30 PM	2/19/20
E. Rosemary Street & W Alley Entrance	AM Peak	8:00 – 9:00 AM	2/25/20
	Noon Peak	12:00 – 1:00 PM	
	PM Peak	5:00 – 6:00 PM	2/19/20
E. Rosemary Street & Wallace Deck West Exit	AM Peak	7:15 – 8:15 AM	2/25/20
	Noon Peak	11:45 AM–12:45 PM	
	PM Peak	4:45 – 5:45 PM	2/19/20
E. Rosemary Street & Wallace Deck East Exit	AM Peak	7:45 – 8:45 AM	2/25/20
	Noon Peak	11:45 AM–12:45 PM	
	PM Peak	4:00 – 5:00 PM	2/19/20
E. Rosemary Street & East Alley Full Access	AM Peak	7:45 – 8:45 AM	2/25/20
	Noon Peak	12:15 – 1:15 PM	
	PM Peak	4:45 – 5:45 PM	2/19/20
E. Rosemary Street & Henderson Street	AM Peak	8:00 – 9:00 AM	2/25/20
	Noon Peak	11:45 AM–12:45 PM	
	PM Peak	4:45 – 5:45 PM	2/19/20
E. Rosemary Street & Hillsborough Street	AM Peak	8:00 – 9:00 AM	2/25/20
	Noon Peak	11:45 AM–12:45 PM	
	PM Peak	5:00 – 6:00 PM	2/19/20

Count Location	Period Counted	Peak Hour	Date of Count
SR 1010 (W. Franklin Street) & Church Street	AM Peak	8:00 – 9:00 AM	2/25/20
	Noon Peak	12:00 – 1:00 PM	
	PM Peak	5:00 – 6:00 PM	1/21/20
SR 1010 (Franklin Street) & NC 86 (Columbia Street)	AM Peak	8:00 – 9:00 AM	2/25/20
	Noon Peak	12:00 – 1:00 PM	
	PM Peak	5:00 – 6:00 PM	1/21/20
SR 1010 (E. Franklin Street) & Henderson Street	AM Peak	8:00 – 9:00 AM	2/25/20
	Noon Peak	11:45 AM–12:45 PM	
	PM Peak	5:00 – 6:00 PM	2/19/20
SR 1010 (E. Franklin Street) & Hillsborough Street / Raleigh Street	AM Peak	8:00 – 9:00 AM	2/25/20
	Noon Peak	12:00 – 1:00 PM	
	PM Peak	5:00 – 6:00 PM	2/19/20
NC 86 (MLK Jr. Blvd) & N. Columbia Street / North Street	AM Peak	7:45 – 8:45 AM	2/25/20
	Noon Peak	12:00 – 1:00 PM	
	PM Peak	5:00 – 6:00 PM	2/19/20
NC 86 (MLK Jr. Boulevard) & Longview Street	AM Peak	7:30 – 8:30 AM	2/25/20
	Noon Peak	11:30 AM–12:30 PM	
	PM Peak	5:00 – 6:00 PM	2/19/20
W. Cameron Avenue & NC 86 SB (Pittsboro Street)	AM Peak	7:30 – 8:30 AM	2/25/20
	Noon Peak	11:45 AM–12:45 PM	
	PM Peak	5:00 – 6:00 PM	2/19/20
Cameron Avenue & NC 86 (S. Columbia Street)	AM Peak	7:30 – 8:30 AM	2/25/20
	Noon Peak	11:45 AM–12:45 PM	
	PM Peak	5:00 – 6:00 PM	2/19/20
E. Cameron Avenue / Country Club Road & Raleigh Street	AM Peak	8:00 – 9:00 AM	2/25/20
	Noon Peak	12:00 – 1:00 PM	
	PM Peak	4:45 – 5:45 PM	2/19/20



B. Approved Background Development Traffic Estimation

Per information from Town of Chapel Hill staff and the Town’s Development Activity Report, potential future developments that are either currently in the concept plan phase, approved, under construction, or are expected to be built out and fully operational by the 2022 and 2023 design analysis years were studied for the inclusion of specific background traffic for this report. In the downtown project study area specifically, on development, Union Chapel Hill Apartments is nearing completion and would be expected to affect 2022 analysis year traffic volumes. **Figure 6** shows the relative location of the Union Chapel Hill Apartments background development as well as location of future transportation network improvement projects. **Figures 7 and 7A** show the total background peak hour traffic volumes estimated for the 2022 Without Site analysis scenario. These volumes include the projected ambient area-wide traffic growth which includes the specific background generator effects beyond the study area. The background traffic volumes for the 2023 analysis year include the 2022 total background traffic volume estimates and the proposed parking deck traffic total assignment. No additional specific background traffic generators are anticipated between 2022 and 2023 within the project study area.

C. Proposed Project Traffic

i. Trip Generation

Proposed Parking Deck

Projected trips for the proposed parking deck redevelopment were generated based on existing traffic count data collected at the current Rosemary Parking Deck, adjacent private surface parking lot facility and Wallace Parking Deck. Existing peak hour activity data for these facilities (trips in/out of the parking facilities) was compared to information provided by the Town and Applicant regarding existing parking occupancies, capacities and future projected deck size. Additional estimates of peak hour activity at the existing Town-owned Columbia/Rosemary Lot #2 was calculated based on a ratio of parking spaces in the lot compared to the other facilities where counts were taken and multiplied by the aggregated number of entry/exit trips from those three facilities.

The method of “generating” parking trips was to consider existing parking deck/lot capacities and utilization and compare to future deck planned capacity and utilization (occupancy). Data from the *Town of Chapel Hill Parking Study*, (Walker Parking Consultants, 2018) is shown in **Table 4** regarding existing parking lot occupancy from the current facilities between 10 AM and 2 PM on a typical weekday.

Table 4. Existing Parking Occupancy Data

Parking Facility	Occupied Spaces	Total Spaces	Occupancy Rate
Rosemary Deck	205	285	72%
Private Surface Lot	93	109	85%
Wallace Deck	300	306	98%
Total	598	700	85%



Data from the Town staff indicate that in total, there are approximately 804 existing parking spaces from these facilities and others nearby (including the Town Columbia/Rosemary Lot #2 surface parking) that may be transferred to the proposed new parking deck. An additional 300 +/- spaces for future growth have been proposed. The resulting existing capacity/new capacity ratio is 1,100 divided by 804 or approximately **1.27**. This “growth factor” was applied to existing traffic volumes under the assumption that the current overall 85%+ utilization rate in existing facilities is desired for the new parking deck and future usage rates during AM, noon, and PM peak hours would remain generally the same as the field data collected. The following text from page 4 of the Town Parking Study explains the occupancy rate and its relation to efficiency and correlation when a parking facility is “full”.

“A parking supply operates at peak efficiency when parking occupancy, including both transient and monthly parking patrons, is approximately 85 percent to 95 percent of the supply. When occupancy exceeds this level, patrons may experience delays and frustration while searching for a space. Therefore, the parking supply may be perceived as inadequate even though there are some spaces available in the parking system.”

Translating the parking occupancy “goals” with peak hour vehicular trips, if the current parking options collectively on E. Rosemary Street are 85% occupancy or above, they are being efficiently utilized on a typical weekday and the corresponding traffic count data for peak hour operations can reasonably be assumed to have a growth factor applied to it as the number of expansion spaces would likely “produce” similar numbers of trips on a per space basis assuming the same desired occupancy rates.

Table 5 shows the total number of vehicular trips that may be generated by East Rosemary Parking Deck during the weekday AM, noon, and PM peak hours of adjacent streets, based on the generation methodologies described above. A peak hour truck percentage of two percent was estimated for all site-generated traffic from the parking deck.

Proposed Office Building

Projected trips for the proposed office building redevelopment were generated based on Institute of Transportation Engineers (ITE) Trip Generation Manual, Volume 10 data for Land Use Code 710 – General Office Building. Using NCDOT guidelines for this land use type, the amount of building square footage was the trip generating variable. The use of the “peak hour of generator” and equation-based estimation methodologies were also employed. No ITE data exists for the noon peak hour, so a conservative estimate of 75 percent of the average of the AM and PM peak generator hours was used to generate noon peak hour trips. According to the Applicant, some of the building space will be used for laboratory functions, which may generate trips at a lower rate than general office space. To be conservative, the entire gross square building footage was considered to be general office space. **Table 6** shows the resulting trip generation for the proposed office building for weekday daily trips as well as the peak hours. A peak hour truck percentage of two percent was estimated for all site-generated traffic from the office building.

It is important to note that the vehicular trip generation estimates from the proposed office building are not entirely “additive” to the parking deck trip generation estimates, as parking spaces for the office building are included in the proposed parking deck and estimates of generated trips and distribution of those trips related to the office building were proportioned to deck estimates and specific parking spaces provided on the office building redevelopment site. More information on this topic is included in **Section II iv**.



Table 5. Weekday Vehicle Trip Generation Summary – Parking Deck

Facility	Units	Daily Estimate [@]			AM Peak Hour			Noon Peak Hour			PM Peak Hour		
		In	Out	Total	In	Out	Total	In	Out	Total	In	Out	Total
Rosemary Deck Counts	285	310	310	620	40	2	42	62	29	91	12	50	62
Private Lot Counts	109	110	110	220	22	0	22	5	1	6	1	18	19
Wallace Deck/Alley Counts	306	945	945	1,890	121	14	135	75	78	153	59	130	189
Existing Columbia / Rosemary Lot #2 Estimates	104	203	203	406	28	3	31	24	19	43	12	32	44
Existing Total Parking Trips (Reallocated to new deck)	804	1,568	1,568	3,136	211	19	230	166	127	293	84	230	314
Proposed Lot Ratio (1100 / 804) – “Net” New Trips	0.269	422	422	844	57	5	62	45	34	79	23	62	85
Total Trips To/From New Deck		1,990	1,990	3,980	268	24	292	211	161	372	107	292	399

@ - No Daily Count Information Available, Estimate is a Factor of 10X the Highest AM/PM Total Peak Hour Count

Table 6. Weekday Vehicle Trip Generation Summary – Office Building

Land Use	ITE LUC	Units	Daily			AM Peak Hour			Noon Peak Hour			PM Peak Hour		
			In	Out	Total	In	Out	Total	In	Out	Total	In	Out	Total
General Office Building	710	200K SF	1,039	1,039	2,078	269	37	306	120	102	222	51	234	285
<i>Transit Reduction</i>		-10%	-104	-104	-208	-27	-4	-31	-12	-10	-22	-5	-23	-28
<i>Pedestrian/Bicycle Reduction</i>		-5%	-52	-52	-104	-13	-2	-15	-6	-5	-11	-3	-12	-15
Total Office Building Vehicular Trips			883	883	1,766	229	31	260	102	87	189	43	199	242

ii.) Adjustments to Trip Generation Rates/Results

Raw ITE trip generation estimates for daily and peak hour trips are typically adjusted for the following factors to reduce raw trip generation estimates to actual estimated vehicular trips produced by the East Rosemary Street Parking Deck redevelopment.

a.) Internal Capture

The East Rosemary Street Parking Deck would not exhibit any potential for internally captured peak period trips for any on-site uses, as its sole function is to serve as a parking deck for downtown activity. The proposed office building is currently considered to have singular uses (no residential or commercial retail uses within it that could possibly contribute to internally captured trips). No additional modifications or reductions were made to trip generation results to account for internal capture.



b.) Modal Split

No mode split adjustments for the parking deck were made for this trip generation analysis, as trips to/from the parking deck are considered to be “vehicle” trips, as the primary function of the deck is to serve vehicular traffic. The deck design may also contain provisions for bicycle parking/storage, but these effects were not considered in the trip generation process.

Mode split adjustments for the proposed office building were considered in this analysis and reflect the likelihood that portions of overall trip-making to/from the office building will use the robust transit service to the downtown Chapel Hill area and may also include pedestrian/bicycle modes. A ten percent overall trip reduction for transit usage and five percent reduction for pedestrian/bicycle trips were used in the study and are reflective of other estimates used in previous development studies in the downtown area.

c.) Pass-by Trips

No pass-by trips were accounted for in this study, since the proposed East Rosemary Parking Deck and Office Building redevelopments are not typical pass-by trip generators.

d.) Trip Generation Budget

Current plans for East Rosemary Parking Deck are for the project to be built in a single phase over a 2 year period. This report considers the full build-out of the entire deck and closure of parking facilities on the site on which it is located, along with the Wallace Deck to the east of the site by the 2022 analysis year. In the 2023 analysis year, the parking deck and new parking facility beneath the proposed office building are assumed to be complete and fully utilized. At this point, no trip generation budget (or potential parking deck size cap) is necessary for future scenarios if the two redevelopment projects are built to the size and intensity as indicated on the site concept plans.

e.) Demolition of Existing Parking Facilities

Table 5 includes the total estimates of existing trips that will be transferred to the new parking deck with the demolition of the adjacent existing parking facilities. With new additional spaces being built above the total existing parking lot capacity along the E. Rosemary Street corridor, a growth ratio was used to calculate “net” new trips for the parking deck.

iii.) Trip Distribution

Trip distribution for parking deck and office building site-related traffic was based existing daily and peak hour traffic patterns to determine the directional peak hour characteristics of traffic to and from the site from the major study area thoroughfares. No local trips to/from lower volume collector and residential streets were estimated, though the possibility exists a small portion of trip-making may occur to/from these local streets. Basic distribution estimates for site traffic flow utilized existing peak hour turning movement counts and overall comparison to local and regional trip attractors. Consideration was also given to existing entry/exit patterns from the existing parking facilities along E. Rosemary Street.

Proposed Parking Deck

Figures 8, 8A, and 8B present the projected trip distribution traffic percentages for the proposed parking deck site in 2022. It was assumed that a majority of site-related trips would use the nearest proposed entrance along E. Rosemary Street for access to the deck internal parking circulation and would exit in a similar fashion from that specific access location. In **Figure 8B**, with a potential proposed full access modification along North Street, it was assumed that all trips from NC 86 (Martin Luther King Jr. Blvd) would use this location for ingress/egress and that the only other site-related



traffic to utilize this location would be a few trips that would enter on E. Rosemary and exit, in this case, east on North Street and then south on Henderson Street.

Proposed Office Building

Trip distribution for proposed office building was assumed to generally follow the same broader study area external distribution patterns. Locally, it was assumed that initially two access points would be established along E. Rosemary Street for the parking facilities at the proposed office building site. As previously mentioned, parking allotments for the new building would include the use of leased and public spaces in the proposed deck along with leased spaces specific to the office building in its structured parking facility. **Figures 9 and 9A** show the trip distribution percentages for vehicles using the proposed Office Building’s structured parking facility.

iv.) Trip Assignment

Proposed Parking Deck

Figures 10, 10A and 10B shows the corresponding East Rosemary Parking Deck site traffic volumes distributed on the 2022 study area network. Total volumes into and out of the site correspond to total external vehicular trips generated, based on the trip generation methodology developed previously.

In the traffic volume development process for the 2022 With Site scenarios, existing trips into/out of the existing parking facilities along E. Rosemary Street were removed from the network in 2022. This was done by taking turning movements in/out of each facility along the E. Rosemary Street corridor and balancing the negative numbers of trips at the NC 86 and Henderson Street intersections and then applying a distribution of these “removed” trips throughout the study area based on existing traffic count data, similar to the distribution process for site trips described above. Then, the total trip generation data for the new deck (existing transferred trips and “net” new trips due to deck parking capacity expansion) were distributed on the network for both scenarios.

Proposed Office Building

Traffic assignment for the proposed office building users was estimated by differentiating office building users who would have available leased/public space in the proposed parking deck and those who might use the 200 space underground structured deck space on the proposed office building site. **Table 7** shows the calculations involved in estimating the proportion of office building-related site trips that are anticipated to use either the proposed E. Rosemary Deck leased spaces or the new parking spaces provided at the proposed office building site. Based on these estimates, approximately 50 percent of office building – related trips were assigned to the on-site office building parking deck and the other 50 percent were accounted for in the trip generation/distribution and assignment methodologies, described previously, for the proposed Town parking deck.

Figures 11 and 11A show the corresponding site traffic assignment estimates for the proposed office building traffic utilizing the structure parking on-site.

Table 7. Office Building Trip Assignment Proportions

Office Building Underground Parking	200	spaces
Parking Deck Spaces Assigned to Applicant in New Deck	250	spaces
<i>Minus Spaces Currently Used by CVS Assigned to New Deck</i>	-68	spaces
Net Spaces for Office Building in Deck	182	spaces
Trips to be assigned to Office Building On-Site Parking Facility		52%
Trips to be assigned to Deck Parking and already included in Deck trip generation		48%



D. Future Traffic Forecasts with the Proposed Redevelopment Projects

Figures 12, 12A and 12B display the 2022 Build-out+1 year projected study area traffic volumes with parking deck site traffic added for the two trip distribution scenarios outlined previously. These traffic volumes represent the aggregate traffic growth over existing traffic volumes for a) ambient traffic growth, b) specific background development traffic generation, and c) estimated site traffic assignment from East Rosemary Parking Deck in each scenario. **Figures 13 and 13A** display the 2023 Build-out+1 year projected study area traffic volumes with the assumed proportion of the office building site traffic that will utilize the 200 space underground garage.

Appendix C contains all the peak hour scenario volume development spreadsheets used in the estimation of 2022 and 2023 analysis year traffic volumes for all scenarios analyzed in this study.

III. IMPACT ANALYSES

A. Peak Hour Intersection Level of Service Analysis

i.) Methodology

Evaluation of traffic operations on suburban arterial, collector, and local roadway facilities is most effective through the determination of level of service (LOS) criteria. The concept of level of service correlates qualitative aspects of traffic flow to quantitative terms. This enables transportation professionals to take the qualitative issues, such as congestion and substandard geometrics, and translate them into measurable quantities, such as operating speeds and vehicular delays. The *Highway Capacity Manual 6th Edition (HCM Version 6)* characterizes level of service by letter designations A through F. Level of service A represents ideal low-volume traffic operations, and level of service F represents over-saturated high-volume traffic operations. Level of service is measured differently for various roadway facilities, but in general, level of service letter designations are described in **Table 8**.

The minimum acceptable peak hour intersection level of service established for this project is LOS D for signalized intersections or LOS E for critical movements at unsignalized intersections, or no increase in delay for signalized intersections operating below LOS D or unsignalized intersection critical movements operating below LOS E without the inclusion of site traffic. The following seven conditions were evaluated:

- **Condition 1** - Existing Traffic
- **Condition 2** - 2022 Traffic without Parking Deck Redevelopment
- **Condition 3** - 2022 Traffic with Parking Deck Redevelopment Traffic Volumes Added (Current Site Concept Plan with E. Rosemary Access Only – Elimination of Current Rosemary and Wallace Decks)
- **Condition 4** - 2022 Traffic with Parking Deck Redevelopment Traffic Volumes and Necessary Mitigation Improvements, Including Alternative Access Scenario
- **Condition 5** - 2023 Traffic without Office Building Redevelopment – Includes Parking Deck Redevelopment
- **Condition 6** - 2023 Traffic with Office Building Traffic Volumes Added
- **Condition 7** – 2023 Traffic with Office Building Traffic Volumes and Necessary Mitigation Improvements (Beyond Recommendations Made for Condition 4)



Table 8. Level of Service (LOS) Characteristics

Level of Service Description	Per Vehicle Delay at Signal	Per Vehicle Delay at Stop Sign
LOS A ➤ Free flow ➤ Freedom to select desired speed and to maneuver is extremely high ➤ General level of comfort and convenience for motorists is excellent	< 10.0 sec	< 10.0 sec
LOS B ➤ Stable flow ➤ Other vehicles in the traffic stream become noticeable ➤ Reduction in freedom to maneuver from LOS A	10.0 – 20.0 sec	10.0 – 15.0 sec
LOS C ➤ Stable flow ➤ Maneuverability and operating speed are significantly affected by other vehicles ➤ General level of comfort and convenience declines noticeably	20.0 – 35.0 sec	15.0 – 25.0 sec
LOS D ➤ High density but stable flow ➤ Speed/freedom to maneuver are very restricted ➤ General level of comfort / convenience is poor ➤ Small increases in traffic will generally cause operational problems	35.0 – 55.0 sec	25.0 – 35.0 sec
LOS E ➤ Unstable flow ➤ Speed reduced to lower but relatively uniform value ➤ Volumes at or near capacity level ➤ Comfort and convenience are extremely poor ➤ Small flow increases or minor traffic stream disturbances will cause breakdowns	55.0 – 80.0 sec	35.0 – 50.0 sec
LOS F ➤ Forced or breakdown flow ➤ Volumes exceed roadway capacity ➤ Formation of unstable queues ➤ Stoppages for long periods of time because of traffic congestion	> 80.0 sec	> 50.0 sec

The *Synchro Professional Version 10* operations analysis software was used to analyze peak hour conditions at signalized intersections. Synchro was also used to analyze peak hour conditions at unsignalized intersections, through the use of its HCM Version 6 two-way stop controlled output function. The methodology of evaluating each condition for signalized intersections is presented below:

- **Condition 1** – Use current Town of Chapel Hill data for the cycle length, splits and offsets of individual signalized intersections and report LOS and delay values from Synchro.
- **Conditions 2-3** – Reoptimize the cycle lengths and splits of individual intersections in Synchro, if existing timing data does not provide adequate overall intersection LOS or due to effects of committed background improvement projects. Adjust cycle lengths, splits, and offsets, if necessary, if the signal is currently operating in a coordinated system. The optimized signal timing information will be held constant for both Conditions, to provide a means to compare effects of the proposed site traffic. No changes to free run signal inputs were made for Conditions 2 and 3.
- **Condition 4** – Optimize coordinated traffic signals for effects of recommended mitigation strategies that change existing/committed changes to lane geometrics. Evaluate the potential for



different signal phasing schemes (left-turn lag phases, for example). Retain existing split minimums and any pedestrian timing values. Recommendations, if warranted, will be made to obtain at least LOS D for the intersection as a whole and account for queue storage issues.

- **Conditions 5-6** – Retain signal timings and any recommended geometric/traffic control/access changes recommended for Condition 4.

- **Condition 7** – Similar potential recommended changes as described in Condition 4.

The net effect of this process is that direct comparisons, by movement, of delay and LOS between each of the seven conditions are impossible because splits and cycle lengths can and do change between conditions. The pertinent statistic of this analysis is the *overall intersection level of service and delay*. Improvements to deficient intersections in Conditions 2 and 3 were made in Condition 4 by first attempting to adjust signal operations via changes in cycle lengths, splits and/or with acceptable adjustments to signal phasing. If that did not produce satisfactory results for all intersections, geometric improvements to improve intersection capacity or changes to existing site access were considered for the deficient intersections. Similar procedures were followed for Conditions 5 and 6 that may result in recommended improvements in Condition 7. **Appendix D** contains the Synchro signalized intersection output for all seven conditions (where applicable).

Unsignalized intersections were analyzed using HCM methodologies. Their results were evaluated on a per-movement basis, since HCM methods do not produce an overall intersection level of service for unsignalized intersections. Thus, intersections with deficient (LOS F) movements in Condition 2 would need to be evaluated for improvements in Condition 3. This methodology differs from signalized intersections, where one or more movements at an intersection may be deficient in Condition 2, but as long as the overall intersection level of service does not fall below LOS D, potentially no intersection improvements may be deemed necessary. **Appendix E** contains the Synchro HCM Version 6 unsignalized output for all stop-controlled intersections under study.

ii.) 2020 Existing Conditions Results

Table 9 presents the results for the existing year traffic conditions as compiled from field data. The table lists LOS and delay values for those movements that are in existence at this time. Currently, all study area signalized intersections operate at an overall acceptable level of service for all of the analyzed 2020 peak hours, though several are near capacity and have approaches and individual turn movements that are at/over capacity in at least one peak hour. The stop-controlled minor street westbound approach at North Street with its intersection with NC 86 operates at a deficient LOS F in the PM peak hour, currently. No other two-way stop-controlled intersection critical movements have deficient peak hour operations in 2020.

iii.) 2022 No-Build Parking Deck Scenario (Condition 2) Results

Table 10 presents the results for the 2022 Build-out+1 analysis year estimated traffic conditions without the impacts of the new parking deck and closure of the adjacent existing parking facilities. This analysis includes ambient area-wide growth over the next two years and assumes the roadway geometric and signal timing changes due to the anticipated Town's W. Franklin Lane Reallocation project. It was assumed that because of signal timing changes necessary specifically at the W. Franklin Street intersections with Church Street and NC 86 (Columbia Street) the entire coordinated signal system in the downtown area would have at least minor adjustments to upstream/downstream signal timings, particularly with signal offsets, due to the change in roadway configuration on W.



Franklin Street and the changes envisioned at the Franklin Street/Columbia Street intersection related to signal phasing.

During Condition 2 - 2022 Without Site Traffic, some delays marginally increase for most study area intersections/critical movements, with the same deficient LOS E or F approaches in the AM and PM peak hours at signalized intersections. With anticipated retiming of intersections along the Franklin Street corridor due to the W. Franklin Street Lane Reallocation project, some intersections (based on projected traffic volumes taken from existing traffic counts) may benefit from the overall retiming to allow slightly better operations than what was reported for Condition 1 – 2020 Existing Traffic. The projected overall intersection LOS at Franklin Street/Columbia Street drops to a LOS E from a LOS D (49.8 to 58.7 seconds/vehicle) in the 2022 Without Site Scenario. This is primarily due to the Lane Reallocation project removing a westbound through travel lane at this intersection.

Maximum queue analyses indicate that at higher volume intersections, queue storage for some left-turn lane may not be adequate in at least one peak hour, similar to conditions experienced in the 2020 Existing conditions scenario. No other operational deficiencies for signalized or unsignalized intersections in the project study area are expected in any of the three peak hours analyzed.

iv.) 2022 Build Parking Deck Scenario (Condition 3) Results

Table 11 presents results for 2022 Build-out+1 year estimated traffic conditions, including impacts of site-related traffic with the current site concept plan. The effects of the proposed parking deck compared to No-Build conditions are “net” impacts focused on traffic volume increases due to increased parking deck capacity and potential traffic redistribution due to existing parking deck and lot closures along E. Rosemary Street and the surrounding streets providing connectivity.

In general, the addition of “net additional” site-related traffic will marginally increase delays at existing intersections and is not expected to cause additional intersections or critical intersection stop-controlled movements to drop to deficient levels in the 2022 analysis year. Due to potential traffic redistributions throughout the network by removing existing parking deck/lot trips and then adding the total deck trip generation demand in estimated distribution patterns, some intersections are shown to slightly “improve” from 2022 Without site conditions.

Overall projected queue and queue storage issues are expected to marginally lengthen/worsen in the Build scenario if additional “net” traffic volumes at a particular location/movement increase. This is also true at the NC 86 / Rosemary Street intersection for the critical westbound approach. In the 2022 PM peak hour, it is likely that the proposed western deck access point would be blocked by westbound queued traffic.



Table 9. Capacity Analysis Results for Study Area Intersections Condition 1 – 2020 Existing Traffic

Intersections / Movements	LOS			Average Vehicular Delay (sec/veh)			95 th % Queue Length (Ft)			Existing Storage (Ft)
	AM	Noon	PM	AM	Noon	PM	AM	Noon	PM	
W. Rosemary Street & Church Street	B	B	B	11.3	10.8	15.8				
EB LT-THRU-RT	A	A	A	5.6	5.8	9.5	100	125	225	N/A
WB LT-THRU-RT	A	A	B	8.4	3.0	12.5	200	50	m250	
NB LT-THRU-RT	C	D	C	25.9	40.3	33.2	75	125	150	
SB LT-THRU-RT	C	C	C	26.8	26.2	26.7	75	50	100	
W. Rosemary Street & NC 86	C	C	C	25.4	32.3	34.6				
EB LT	D	D	F	38.9	43.1	86.0	150	125	#325	100
EB THRU-RT	C	C	D	30.3	34.1	37.7	200	250	300	150
WB LT	D	D	E	36.4	46.7	60.3	m25	m75	100	
WB THRU-RT	E	E	F	62.8	74.0	95.2	275	325	#425	75
NB LT	A	B	A	8.4	12.4	9.0	m25	m50	m25	
NB THRU-RT	B	B	B	11.6	15.2	13.0	75	150	100	
SB LT	B	B	B	13.8	17.5	16.7	75	75	75	
SB THRU	C	C	C	21.6	24.3	24.9	250	175	225	150
SB RT	B	B	B	10.2	17.1	16.1	125	150	175	
E. Rosemary St & Rosemary Parking Dk	N/A	N/A	N/A	N/A	N/A	N/A				
EB LT	A	A	A	8.0	8.1	8.0	25	25	0	125
SB LT-RT	B	B	B	11	12.0	12.0	0	25	25	
E. Rosemary St & Wallace Deck West Dr	N/A	N/A	N/A	N/A	N/A	N/A				
WB LT	A	A	A	8.0	8.2	8.4	25	25	25	75
NB LT-RT	B	B	B	11.5	12.0	12.7	25	25	25	
E. Rosemary St & Wallace Deck East Dr	N/A	N/A	N/A	N/A	N/A	N/A				
WB LT	A	A	A	7.7	8.0	8.4	0	0	0	0
NB LT-RT	B	B	B	10.5	11.2	12.9	25	25	25	
E. Rosemary Street & Henderson Street	A	B	B	8.0	12.7	13.4				
EB LT	A	A	A	2.8	4.6	4.3	m25	m25	m25	75
EB THRU-RT	A	A	A	3.0	6.5	7.5	50	150	300	
WB LT-THRU-RT	A	A	A	5.3	4.6	7.7	125	75	150	
NB LT-THRU-RT	C	D	D	26.9	37.8	40.7	50	50	100	
SB LT-THRU-RT	C	C	C	23.9	22.6	27.2	50	50	75	
E. Rosemary Street & Hillsborough Street	B	B	B	14.8	18.8	17.5				
EB LT-THRU-RT	C	D	C	20.3	44.4	27.0	50	150	125	100
WB LT-THRU-RT	C	C	C	28.8	21.5	26.3	75	50	100	
NB LT	A	A	A	6.8	6.4	8.3	75	75	75	
NB THRU-RT	A	A	A	5.8	5.6	8.7	75	75	125	
SB LT	B	B	B	11.5	13.6	16.0	25	25	50	100
SB THRU-RT	B	B	B	13.9	14.5	16.4	200	125	150	
W. Franklin Street & Church Street	A	B	B	6.4	10.7	15.0				
EB LT	A	A	B	4.8	6.7	10.4	25	25	50	150
EB THRU-RT	A	A	A	4.3	5.4	8.0	50	75	100	
WB LT	A	A	B	4.4	6.1	13.5	m25	m25	m50	200
WB THRU-RT	A	A	B	3.4	6.8	13.9	75	50	275	
NB LT-THRU	B	B	C	19.9	19.9	21.0	25	25	75	100
NB RT	C	C	B	20.4	20.2	19.3	25	25	50	
SB LT-THRU-RT	C	D	C	22.2	38.5	33.0	75	75	125	
Cameron Ave/Country Club Rd & Raleigh	C	C	C	22.8	20.4	29.6				
EB LT-THRU-RT	C	C	C	22.1	25.1	34.7	100	125	225	150
WB LT	B	B	B	12.4	13.5	14.9	25	25	50	
WB THRU-RT	C	C	C	24.8	22.1	24.6	250	175	250	125
NB LT	B	B	B	14.6	12.3	17.3	25	25	50	
NB THRU-RT	C	C	D	31.7	29.4	42.7	75	100	175	
SB LT	C	B	C	20.3	14.5	25.1	#200	125	#225	
SB THRU-RT	C	B	C	21.9	18.8	32.1	175	125	250	75

Intersections / Movements	LOS			Average Vehicular Delay (sec/veh)			95 th % Queue Length (Ft)			Existing Storage (Ft)
	AM	Noon	PM	AM	Noon	PM	AM	Noon	PM	
Franklin Street & NC 86 (Columbia Street)	C	D	D	33.1	40.8	49.8				
EB LT	E	F	F	70.2	86.8	91.9	100	150	#275	250
EB THRU-RT	C	C	D	29.2	26.7	35.8	200	200	275	
WB LT	E	E	E	78.3	62.1	79.4	125	100	175	125
WB THRU-RT	B	C	E	15.1	28.4	57.2	75	250	400	
NB LT	D	E	D	36.2	73.7	46.9	m50	100	m75	475
NB THRU-RT	C	D	D	34.9	37.6	48.3	225	225	#500	
SB LT	F	F	F	92.5	91.7	104.0	75	100	m150	125
SB THRU-RT	C	D	C	31.0	41.3	27.0	125	100	125	
E. Franklin Street & Henderson Street	A	B	B	7.4	12.7	15.8				
EB LT-THRU	A	A	A	5.8	6.3	6.7	100	125	m75	N/A
WB THRU-RT	A	A	B	5.4	9.2	13.3	175	175	300	
SB LT-RT	C	D	D	24.0	35.0	46.6	50	75	175	
E. Franklin St & Hillsborough/Raleigh St	C	C	C	32.0	29.9	31.9				
EB LT	B	B	B	19.1	12.9	14.6	50	m75	m75	75
EB THRU-RT	B	B	B	15.8	11.8	16.0	175	200	350	
WB LT	B	B	B	16.3	11.0	10.2	50	50	50	75
WB THRU-RT	B	B	B	15.7	10.5	10.1	200	175	275	
NB LT-THRU-RT	E	F	F	73.2	94.9	136.6	300	325	#400	100
SB LT	C	D	E	30.1	39.8	55.5	50	75	75	
SB THRU-RT	D	D	E	42.7	44.9	57.8	375	175	200	
NC 86 & N. Columbia St / North Street	N/A	N/A	N/A	N/A	N/A	N/A				
NB LT	A	A	A	9.8	9.0	9.9	25	25	25	150
SB LT	A	A	B	8.5	8.7	10.5	0	0	25	
EB LT-THRU-RT	C	B	C	15.1	13.3	21.4	25	25	50	150
WB LT-THRU-RT	B	B	F	13.2	14.6	85.5	25	25	125	
NC 86 (MLK Jr. Blvd) & Longview Street	A	A	A	9.4	5.5	8.0				
EB LT-THRU-RT	B	B	B	17.5	12.3	18.3	50	25	75	225
WB LT-THRU-RT	B	B	B	12.0	10.3	15.5	25	25	50	
NB LT	A	A	A	6.5	5.6	6.0	25	25	25	250
NB THRU-RT	A	A	A	7.2	5.0	7.4	75	75	150	
SB LT	A	A	A	0.0	5.0	6.1	N/A	25	25	
SB THRU-RT	A	A	A	8.9	5.1	6.6	125	75	100	
W. Cameron Ave & NC 86 (Pittsboro St)	C	C	C	24.0	21.5	30.8				
EB THRU-RT	E	C	E	58.1	32.3	66.0	#225	225	450	75
WB LT	B	C	C	11.3	22.2	24.4	250	200	m250	
WB THRU	A	A	A	5.0	5.1	2.5	m75	m100	m50	
Cameron Ave & NC 86 (S. Columbia St)	C	C	D	32.1	33.4	47.9				
EB LT	C	F	E	30.8	86.0	74.7	m25	m25	m25	100
EB THRU	D	F	E	35.9	83.1	73.7	m75	m75	m175	
WB THRU-RT	E	E	F	62.4	71.6	90.3	150	175	#375	300
NB LT	C	C	C	26.9	24.2	34.4	125	175	250	
NB LT-THRU-RT	C	C	D	29.9	24.2	45.0	225	200	450	
SB LT	C	B	C	23.8	14.5	30.4	m50	m50	100	
SB RT	C	C	D	28.0	27.4	36.3	150	225	175	

N/A – Not Applicable, i.e. movement is non-existent or overall intersection values are not reported for unsignalized intersections
BOLD/ITALICS – Movement or overall intersection is over Town TIS Guidelines threshold capacity
PURPLE – Maximum Queue May Exceed Storage Bay Distance
 m – Volume for 95th percentile queue is metered by upstream signal
 # – 95th percentile volume exceeds capacity, queue may be longer (queue shown is maximum after 2 cycles)



Table 10. Capacity Analysis Results for Study Area Intersections Condition 2 – 2022 Traffic Without Proposed Parking Deck

Intersections / Movements	LOS			Average Vehicular Delay (sec/veh)			95 th % Queue Length (Ft)			Future Storage (Ft)
	AM	Noon	PM	AM	Noon	PM	AM	Noon	PM	
W. Rosemary Street & Church Street	A	A	B	9.2	9.5	13.9				
EB LT-THRU-RT	A	A	A	5.7	6.0	9.9	125	125	225	N/A
WB LT-THRU-RT	A	A	A	3.3	2.6	5.9	50	50	m100	
NB LT-THRU-RT	C	C	D	24.6	31.6	36.9	75	75	m100	
SB LT-THRU-RT	C	C	C	27.1	26.2	26.6	75	50	100	
W. Rosemary Street & NC 86	C	C	D	26.6	29.6	35.9				
EB LT	D	C	F	38.8	29.6	100.5	150	125	#375	100
EB THRU-RT	C	C	D	33.5	27.3	44.3	225	225	400	150
WB LT	D	D	D	36.2	41.1	54.3	m50	75	100	
WB THRU-RT	E	D	F	58.8	54.5	92.9	200	#400	#450	75
NB LT	B	B	A	11.0	16.4	5.6	m25	m50	m25	
NB THRU-RT	B	C	B	14.1	20.3	10.1	100	125	m75	150
SB LT	B	C	B	15.3	21.9	17.3	75	75	75	
SB THRU	C	C	C	23.8	30.3	25.6	275	175	250	400
SB RT	B	B	B	10.8	17.4	16.9	125	125	200	
E. Rosemary St & Rosemary Parking Dk	N/A	N/A	N/A	N/A	N/A	N/A				
EB LT	A	A	A	8.1	8.1	8.0	25	25	0	125
SB LT-RT	B	B	B	11.1	12.2	12.3	0	25	25	
E. Rosemary St & Wallace Deck West Dr	N/A	N/A	N/A	N/A	N/A	N/A				
WB LT	A	A	A	8.0	8.2	8.5	25	25	25	75
NB LT-RT	B	B	B	11.6	12.2	12.9	25	25	25	
E. Rosemary St & Wallace Deck East Dr	N/A	N/A	N/A	N/A	N/A	N/A				
WB LT	A	A	A	7.7	8.0	8.4	0	0	0	0
NB LT-RT	B	B	B	10.6	11.4	13.1	25	25	25	
E. Rosemary Street & Henderson Street	A	B	B	8.5	12.4	11.3				
EB LT	A	A	A	5.6	5.6	6.1	m25	m25	m25	75
EB THRU-RT	A	A	A	5.5	5.6	7.8	100	100	250	
WB LT-THRU-RT	A	A	A	5.1	6.6	5.2	100	125	125	
NB LT-THRU-RT	C	D	C	27.1	36.1	28.4	75	75	50	
SB LT-THRU-RT	C	C	C	24.0	21.4	26.2	50	50	75	
E. Rosemary Street & Hillsborough Street	B	B	B	15.0	15.5	17.4				
EB LT-THRU-RT	C	C	C	28.6	31.4	30.0	100	100	125	100
WB LT-THRU-RT	C	C	C	29.0	21.3	25.6	100	50	100	
NB LT	A	A	A	3.4	6.5	6.9	25	75	75	
NB THRU-RT	A	A	A	2.3	5.7	7.5	25	100	175	
SB LT	B	B	B	11.0	13.0	16.2	25	25	50	100
SB THRU-RT	B	B	B	14.3	14.7	17.0	225	150	150	
W. Franklin Street & Church Street	A	B	B	7.8	11.8	18.3				
EB LT	A	A	B	5.0	7.2	12.0	25	50	50	150
EB THRU-RT	A	A	B	6.4	8.7	13.3	125	175	275	
WB LT	A	A	A	2.4	7.5	9.9	m25	m50	m25	200
WB THRU-RT	A	A	B	4.3	8.7	17.4	50	300	m325	
NB LT-THRU	B	B	C	19.7	19.1	20.6	25	25	75	100
NB RT	C	B	B	20.2	19.3	19.0	25	25	50	
SB LT-THRU-RT	C	C	D	24.6	32.2	35.4	75	75	125	
Cameron Ave/Country Club Rd & Raleigh	C	C	C	23.7	21.0	30.7				
EB LT-THRU-RT	C	C	D	22.0	25.4	35.2	100	125	225	150
WB LT	B	B	B	12.5	13.7	15.2	25	25	50	
WB THRU-RT	C	C	C	25.4	23.1	26.1	250	175	275	125
NB LT	B	B	B	15.1	12.5	17.7	25	25	75	
NB THRU-RT	C	C	D	32.4	30.1	43.5	75	100	175	75
SB LT	C	B	C	22.6	15.1	26.9	#250	150	#250	
SB THRU-RT	C	B	C	22.4	19.1	32.7	175	125	250	

Intersections / Movements	LOS			Average Vehicular Delay (sec/veh)			95 th % Queue Length (Ft)			Future Storage (Ft)
	AM	Noon	PM	AM	Noon	PM	AM	Noon	PM	
Franklin Street & NC 86 (Columbia Street)	C	D	E	30.5	41.0	58.7				
EB LT	E	E	F	75.6	76.2	145.4	125	150	#375	250
EB THRU-RT	C	C	D	23.7	31.0	35.8	150	225	300	
WB LT	E	F	F	79.7	82.4	93.2	125	150	175	125
WB THRU	C	D	F	21.0	38.4	88.5	175	#475	#775	
WB RT	A	B	C	8.5	13.5	21.6	25	75	m75	DROP
NB LT	E	F	F	79.8	100.5	98.8	m50	125	m75	
NB THRU-RT	C	C	C	20.5	29.6	31.4	150	75	m#425	475
SB LT	F	F	F	92.4	93.2	131.6	75	100	m#175	
SB THRU-RT	C	C	D	29.7	34.7	35.5	100	100	#250	125
E. Franklin Street & Henderson Street	A	B	B	7.8	12.6	13.5				
EB LT-THRU	A	A	A	6.8	6.5	9.7	175	150	m200	N/A
WB THRU-RT	A	A	A	4.5	8.3	5.9	25	175	175	
SB LT-RT	C	D	D	28.0	35.8	44.1	75	150	150	
E. Franklin St & Hillsborough/Raleigh St	C	C	C	22.6	23.6	21.6				
EB LT	B	B	A	14.7	13.8	6.4	25	75	m25	75
EB THRU-RT	B	B	A	13.9	11.7	5.3	100	175	150	
WB LT	C	B	B	22.5	15.4	13.4	75	50	75	75
WB THRU-RT	C	B	B	21.7	14.8	13.4	250	200	350	
NB LT-THRU-RT	D	D	E	35.5	51.3	76.9	250	300	350	100
SB LT	B	C	D	16.0	31.1	43.6	75	100	100	
SB THRU-RT	C	D	D	24.7	38.8	44.5	225	200	225	
NC 86 & N. Columbia St / North Street	N/A	N/A	N/A	N/A	N/A	N/A				
NB LT	B	A	B	10.1	9.2	10.1	25	25	25	150
SB LT	A	A	B	8.5	8.8	10.8	0	0	25	
EB LT-THRU-RT	C	B	C	15.7	13.8	24.4	25	25	50	150
WB LT-THRU-RT	B	C	F	13.7	15.3	119.6	25	25	150	
NC 86 (MLK Jr. Blvd) & Longview Street	A	A	A	9.5	5.6	8.1				
EB LT-THRU-RT	B	B	B	17.7	12.5	18.7	50	50	75	225
WB LT-THRU-RT	B	B	B	12.1	10.7	15.7	25	25	50	
NB LT	A	A	A	6.5	5.6	6.0	25	25	25	100
NB THRU-RT	A	A	A	7.3	5.0	7.5	75	75	150	
SB LT	A	A	A	0.0	5.0	6.1	0	25	25	250
SB THRU-RT	A	A	A	9.1	5.1	6.6	125	75	125	
W. Cameron Ave & NC 86 (Pittsboro St)	B	B	C	17.1	19.9	21.0				
EB THRU-RT	C	C	D	27.6	21.2	48.3	175	175	450	75
WB LT	B	C	B	14.4	27.1	14.5	200	250	m125	
WB THRU	A	A	A	5.9	3.6	1.4	m100	m75	m25	
Cameron Ave & NC 86 (S. Columbia St)	C	C	D	27.9	32.6	45.5				
EB LT	C	D	C	34.9	36.4	23.2	m25	m50	m25	100
EB THRU	D	C	C	41.2	33.5	20.4	m125	100	m125	
WB THRU-RT	E	E	F	62.3	70.0	91.7	150	175	#375	300
NB LT	C	C	D	27.9	23.0	37.3	125	175	275	
NB LT-THRU-RT	C	C	D	31.4	23.1	53.6	225	200	#500	300
SB LT	A	B	C	7.2	18.6	20.4	m25	m50	m125	
SB RT	B	D	C	17.1	35.1	29.4	325	275	300	

N/A – Not Applicable, i.e. movement is non-existent or overall intersection values are not reported for unsignalized intersections
BOLD/ITALICS – Movement or overall intersection is over Town TIS Guidelines threshold capacity
BLUE – Town Committed Project Improvement **PURPLE** – Maximum Queue May Exceed Storage Bay Distance
m – Volume for 95th percentile queue is metered by upstream signal
– 95th percentile volume exceeds capacity, queue may be longer (queue shown is maximum after 2 cycles)



Table 11. Capacity Analysis Results for Study Area Intersections Condition 3 – 2022 Traffic With Site (Rosemary-Only Access Concept)

Intersections / Movements	LOS			Average Vehicular Delay (sec/veh)			95 th % Queue Length (Ft)			Future Storage (Ft)
	AM	Noon	PM	AM	Noon	PM	AM	Noon	PM	
W. Rosemary Street & Church Street	A	A	B	9.3	9.5	13.8				
EB LT-THRU-RT	A	A	A	5.8	6.1	9.9	125	125	225	N/A
WB LT-THRU-RT	A	A	A	3.4	2.6	5.8	50	m50	m100	
NB LT-THRU-RT	C	C	D	24.8	31.9	36.9	75	75	m100	
SB LT-THRU-RT	C	C	C	26.6	26.0	26.6	75	50	100	
W. Rosemary Street & NC 86	C	C	D	26.6	32.3	48.5				
EB LT	D	C	F	38.5	31.0	124.3	150	125	#400	100
EB THRU-RT	C	C	D	33.5	27.4	44.2	250	250	425	75
WB LT	D	D	E	35.3	43.1	64.5	50	100	150	
WB THRU-RT	E	E	F	58.1	65.4	163.1	225	#500	#600	
NB LT	B	B	A	12.4	16.4	5.6	m25	m50	m25	75
NB THRU-RT	B	C	B	15.7	21.4	11.4	125	125	m75	150
SB LT	B	C	B	16.9	23.7	18.7	100	100	75	
SB THRU	C	C	C	24.0	30.3	26.0	275	175	250	400
SB RT	B	B	B	11.0	17.4	17.1	125	125	200	
E. Rosemary St & Proposed Parking Dk W	N/A	N/A	N/A	N/A	N/A	N/A				
EB LT	A	A	A	8.3	8.2	8.2	25	25	25	75
SB LT-RT	B	B	B	10.8	12.7	13.8	25	50	50	50
E. Rosemary St & Proposed Parking Dk E	N/A	N/A	N/A	N/A	N/A	N/A				
EB LT	A	A	A	8.2	8.1	8.0	25	25	25	75
SB LT-RT	B	B	B	11.5	12.8	13.5	25	25	50	50
E. Rosemary Street & Henderson Street	A	B	B	9.2	12.1	11.2				
EB LT	A	A	A	6.0	5.3	5.9	m25	m25	m25	75
EB THRU-RT	A	A	A	5.3	5.5	7.1	100	125	225	75
WB LT-THRU-RT	A	A	A	5.5	6.0	5.2	100	125	125	
NB LT-THRU-RT	C	D	C	27.8	35.4	28.6	100	75	50	
SB LT-THRU-RT	C	C	C	23.5	22.4	26.9	50	50	75	
E. Rosemary Street & Hillsborough Street	B	B	B	15.1	15.4	17.7				
EB LT-THRU-RT	C	C	C	28.7	31.8	32.3	100	125	150	100
WB LT-THRU-RT	C	C	C	29.0	21.9	27.9	100	50	125	
NB LT	A	A	A	3.1	6.3	6.3	25	75	75	100
NB THRU-RT	A	A	A	2.4	5.7	7.0	25	100	150	
SB LT	B	B	B	10.8	12.8	15.4	25	25	50	100
SB THRU-RT	B	B	B	13.4	14.4	16.1	225	150	150	
W. Franklin Street & Church Street	A	B	B	7.7	12.7	18.5				
EB LT	A	A	B	5.0	7.6	12.2	25	50	50	150
EB THRU-RT	A	A	B	6.5	9.1	13.5	125	200	275	200
WB LT	A	A	A	2.2	8.2	10.0	m25	m50	m25	
WB THRU-RT	A	B	B	4.1	10.2	17.5	50	325	m325	100
NB LT-THRU	B	B	C	19.7	18.6	20.4	25	25	75	
NB RT	C	B	B	20.2	18.8	18.8	25	25	50	100
SB LT-THRU-RT	C	C	D	24.7	32.5	35.7	75	75	125	
Cameron Ave/Country Club Rd & Raleigh	C	C	C	22.9	20.8	30.4				
EB LT-THRU-RT	C	C	D	22.5	25.4	35.1	100	125	225	150
WB LT	B	B	B	12.6	13.7	15.1	25	25	50	
WB THRU-RT	C	C	C	24.8	22.5	25.8	250	175	250	125
NB LT	B	B	B	14.4	12.5	17.6	25	25	75	
NB THRU-RT	C	C	D	31.5	30.0	43.4	75	100	175	75
SB LT	C	B	C	21.2	14.8	25.6	#225	150	#225	
SB THRU-RT	C	B	C	21.6	19.0	32.9	175	125	250	

Intersections / Movements	LOS			Average Vehicular Delay (sec/veh)			95 th % Queue Length (Ft)			Future Storage (Ft)
	AM	Noon	PM	AM	Noon	PM	AM	Noon	PM	
Franklin Street & NC 86 (Columbia Street)	C	D	E	31.0	40.9	57.8				
EB LT	E	E	F	77.6	76.0	152.0	125	150	#375	250
EB THRU-RT	C	C	D	23.7	32.3	36.0	150	225	300	125
WB LT	E	F	F	79.5	84.2	94.1	125	150	175	
WB THRU	C	D	F	22.2	39.1	89.0	#175	#500	#775	475
WB RT	A	B	C	9.1	13.6	21.4	25	75	75	
NB LT	F	F	F	80.9	100.2	101.0	m50	125	m75	125
NB THRU-RT	C	C	C	21.3	28.9	25.7	175	75	m175	
SB LT	F	F	F	93.3	90.2	127.2	75	100	m#175	
SB THRU-RT	C	C	D	29.6	33.8	37.7	75	100	#375	
E. Franklin Street & Henderson Street	A	B	B	8.0	12.2	12.1				
EB LT-THRU	A	A	A	6.7	6.6	9.0	175	175	m200	N/A
WB THRU-RT	A	A	A	4.9	7.5	5.3	25	150	150	
SB LT-RT	C	D	D	28.7	36.2	41.8	50	125	125	
E. Franklin St & Hillsborough/Raleigh St	C	C	C	22.6	24.2	21.3				
EB LT	B	B	A	14.2	13.4	6.0	25	75	m25	75
EB THRU-RT	B	B	A	13.3	11.2	4.9	100	175	100	75
WB LT	C	B	B	22.0	14.3	12.5	75	50	75	
WB THRU-RT	C	B	B	20.8	13.8	12.7	225	200	325	100
NB LT-THRU-RT	D	D	F	36.7	54.7	80.4	225	300	350	
SB LT	B	C	D	17.0	33.7	40.4	75	100	75	
SB THRU-RT	C	D	D	26.4	42.4	44.1	250	225	225	
NC 86 & N. Columbia St / North Street	N/A	N/A	N/A	N/A	N/A	N/A				
NB LT	B	A	B	10.3	9.3	10.1	25	25	25	150
SB LT	A	A	B	8.5	8.9	11.3	0	0	25	150
EB LT-THRU-RT	C	B	D	16.4	14.3	29.6	25	25	75	175
WB LT-THRU-RT	B	C	F	13.9	15.9	169.7	25	25		
NC 86 (MLK Jr. Blvd) & Longview Street	A	A	A	9.6	5.6	8.1				
EB LT-THRU-RT	B	B	C	18.6	12.7	20.2	50	50	100	225
WB LT-THRU-RT	B	B	B	12.8	10.8	17.0	25	25	50	
NB LT	A	A	A	6.0	5.4	5.7	25	25	25	250
NB THRU-RT	A	A	A	7.1	5.1	7.5	75	75	150	
SB LT	A	A	A	0.0	5.0	6.0	0	25	25	125
SB THRU-RT	A	A	A	9.2	5.1	6.4	125	75		
W. Cameron Ave & NC 86 (Pittsboro St)	B	C	C	17.2	20.2	20.4				
EB THRU-RT	C	C	D	28.0	21.3	48.1	175	175	450	75
WB LT	B	C	B	14.4	27.3	13.5	200	250	m125	
WB THRU	A	A	A	5.9	3.8	1.6	m100	m75	m50	
Cameron Ave & NC 86 (S. Columbia St)	C	C	D	28.3	33.4	54.1				
EB LT	D	D	C	36.2	38.0	23.8	m25	m50	m25	100
EB THRU	D	C	C	41.1	33.6	20.4	m125	100	m125	
WB THRU-RT	E	E	F	62.3	70.0	91.7	150	175	#375	300
NB LT	C	C	D	28.0	23.3	42.1	125	175	275	
NB LT-THRU-RT	C	C	E	32.3	23.7	77.3	250	225	#550	
SB LT	A	B	B	7.1	19.1	18.1	m25	m50	m125	125
SB RT	B	D	C	17.0	36.8	27.3	300	300	350	

N/A – Not Applicable, i.e. movement is non-existent or overall intersection values are not reported for unsignalized intersections
BOLD/ITALICS – Movement or overall intersection is over Town TIS Guidelines threshold capacity
GREEN – Applicant Proposed Improvement **PURPLE** – Maximum Queue May Exceed Storage Bay Distance
 m – Volume for 95th percentile queue is metered by upstream signal
 # – 95th percentile volume exceeds capacity, queue may be longer (queue shown is maximum after 2 cycles)



v.) 2022 Build Scenario With North Street Access (Condition 4) Results

Table 12 presents results for 2022 Build-out+1 year estimated traffic conditions, including impacts of site-related traffic with the site concept plan modified for the following access changes:

- One primary full movement access location on E. Rosemary Street located approximately 450 feet east of the NC 86 (N. Columbia Street) intersection. Parking deck exit to have separate left and right-turn exit lanes.
- One full movement access connection on North Street to the Proposed Deck located approximately 175 feet east of NC 86 (N. Columbia Street). Parking deck exit to have one shared left/right turn lane with a stop sign.

**Table 12. Capacity Analysis Results for Study Area Intersections
 Condition 4 – 2022 Traffic With Site (North Street Access Concept)**

Intersections / Movements	LOS			Average Vehicular Delay (sec/veh)			95 th % Queue Length (Ft)			Future Storage (Ft)
	AM	Noon	PM	AM	Noon	PM	AM	Noon	PM	
W. Rosemary Street & NC 86	C	C	C	24.4	26.1	32.1				
EB LT	D	C	<i>F</i>	38.9	29.3	100.3	150	125	#375	100
EB THRU-RT	C	C	D	33.8	27.4	44.6	250	250	425	
WB LT	D	D	<i>E</i>	35.7	42.5	66.0	50	100	150	150
WB THRU-RT	<i>E</i>	D	<i>F</i>	57.9	53.1	89.7	200	#400	#425	
NB LT	B	B	A	12.1	16.4	5.6	m25	m50	m25	75
NB THRU-RT	B	B	A	14.8	19.7	9.0	125	125	m75	
SB LT	B	B	B	13.5	14.7	10.4	50	25	m25	150
SB THRU	B	B	B	17.9	19.8	14.2	150	100	125	
SB RT	A	A	A	7.3	9.3	7.7	50	50	75	400
NC 86 & N. Columbia St / North Street	B	B	C	11.7	18.4	23.2				
WB LT-THRU-RT	<i>E</i>	<i>E</i>	<i>E</i>	56.5	63.0	70.5	50	150	275	
NB LT	A	A	B	4.5	8.5	12.6	m25	m25	m25	150
NB THRU	A	A	B	3.7	7.2	12.8	50	100	m175	
SB LT	A	B	B	9.5	13.0	17.6	75	75	75	150
SB THRU	A	B	B	9.5	12.4	16.0	225	200	275	
EB LT-THRU-RT	<i>E</i>	<i>E</i>	<i>E</i>	57.3	63.2	80.0	100	125	#200	
E. Rosemary St & Proposed Parking Deck Single Access Point	N/A	N/A	N/A	N/A	N/A	N/A				
EB LT	A	A	A	8.4	8.2	8.0	25	25	25	150
SB LT	B	C	C	13.8	15.1	15.2	25	25	25	50
SB RT	B	B	B	10.3	10.8	11.2	25	25	25	50
North Street & Proposed Parking Deck Full Movement Access	N/A	N/A	N/A	N/A	N/A	N/A				
WB LT-THRU	A	A	A	0.0	0.0	0.0	0	0	0	
NB LR-RT	A	A	B	8.9	9.3	10.0	0	25	25	150

N/A – Not Applicable, i.e. movement is non-existent or overall intersection values are not reported for unsignalized intersections

BOLD/ITALICS – Movement or overall intersection is over Town TIS Guidelines threshold capacity

GREEN – Recommended Improvement

PURPLE – Maximum Queue May Exceed Storage Bay Distance

m – Volume for 95th percentile queue is metered by upstream signal

– 95th percentile volume exceeds capacity, queue may be longer (queue shown is maximum after 2 cycles)

The full North Street Modified Access Concept improves overall and individual movement LOS and delays at the NC 86 intersection with Rosemary Street compared to the initial access plan analyzed in Condition 3 previously. It also provides adequate separation from the Rosemary Street/NC 86 intersection to better allow left-turning vehicles turning into the deck from conflicting with westbound left-turning vehicles at the signalized intersection, as well as providing an exit point that would likely



not be blocked by westbound through traffic queues (in the PM peak hour) on E. Rosemary Street. The primary traffic impact will be at the NC 86 N. Columbia Street and North Street intersection with the westbound movements experiencing high delays and queues. Therefore, to preserve full access at this location and allow for efficient and safe ingress and egress for parking deck-related and existing local traffic a traffic signal was analyzed at this location. Operational results indicate that a three-phase traffic signal (with split side street phasing) should operate acceptably in all 2022 peak hours analyzed.

This scenario was also analyzed in Synchro's SimTraffic companion microsimulation software package for the worst-case 2022 PM peak hour conditions. **Appendix F** provides the detailed SimTraffic Queueing and Blocking report. At the critical Rosemary Street/NC 86 intersection westbound approach, 2022 PM peak maximum queues are not expected to spillback beyond the proposed single primary deck access point along E. Rosemary Street.

Figure 14 shows peak hour LOS results comparison between the 2022 No-Build and 2022 Build With Access Modification scenarios. Outside of the immediate area where parking deck volume changes are expected, there should be negligible differences between the two Build Scenarios at intersections further away from the site.

vi.) 2023 No-Build Office Building Scenario (Condition 5) Results

Table 13 presents the results for the 2023 Build-out+1 analysis year estimated traffic conditions without the impacts of the office building redevelopment but with the assumption that the new parking deck is complete and that the proposed recommendations for access from Condition 4 have been implemented. This analysis includes ambient area-wide growth over the 2022-2023 time period. It also assumes no changes to traffic signal operations from the 2022 With Site and Access Modifications Scenario.

Analysis results indicate that there are only marginal LOS and delay differences between the 2023 No-Build Scenario and the 2022 Build Scenarios, as only small increases in background traffic growth are expected in the project study area.

vii.) 2023 Build Office Building Scenario (Condition 6) Results

Table 14 presents the results for the 2023 Build-out+1 analysis year with the addition of office building traffic utilizing the on-site structured parking lot. As previously described, some office building generated trips were previously conservatively accounted for in the parking deck trip generation estimation and 2022 analyses. This scenario includes the full effects of both redevelopment projects, with the assumptions for deck access made in Condition 4.

Compared to Condition 5, the results in **Table 14** show that there are relatively few substantial degradations of LOS/large increases in overall signalized vehicular delays caused by the additional Office Building site traffic that is being assigned to the on-site parking facility. Anticipated trip distributions of this traffic area spread out through downtown project study area, lessening effects on individual intersections, with a few exceptions. PM peak hour delays increase by approximately seven seconds per vehicle at the NC 86 (N. Columbia St) intersection with Rosemary Street and also at the NC 86 intersection with Cameron Street. Deficient stop-controlled left-turn delays at NC 86 and North Street/N. Columbia Street also continue to increase, as small increases in major street traffic continue to limit acceptable gaps to make left-turns at this location.

Figure 15 presents a comparison of 2023 overall intersection LOS results (for signalized intersections) or critical movement stop-controlled results (for unsignalized intersections).



Table 13. Capacity Analysis Results for Study Area Intersections Condition 5 – 2023 Traffic Without Office Building

Intersections / Movements	LOS			Average Vehicular Delay (sec/veh)			95 th % Queue Length (Ft)			Future Storage (Ft)
	AM	Noon	PM	AM	Noon	PM	AM	Noon	PM	
W. Rosemary Street & Church Street	A	A	B	9.4	9.4	13.8				
EB LT-THRU-RT	A	A	B	5.8	6.1	10.1	125	125	250	N/A
WB LT-THRU-RT	A	A	A	3.5	2.5	5.4	50	50	m100	
NB LT-THRU-RT	C	C	D	24.9	32.2	36.9	75	75	m100	
SB LT-THRU-RT	C	C	C	26.6	26.0	26.6	75	50	100	
W. Rosemary Street & NC 86	C	C	C	24.1	26.2	33.3				
EB LT	D	C	F	39.2	29.5	104.1	150	125	#375	100
EB THRU-RT	C	C	D	33.8	27.4	44.8	250	250	425	150
WB LT	D	D	E	35.6	42.9	66.5	50	100	150	
WB THRU-RT	E	D	F	58.1	53.7	90.9	200	#400	#425	75
NB LT	B	B	A	12.4	16.5	5.6	m25	m50	m25	
NB THRU-RT	B	B	B	15.0	19.9	10.3	125	125	m75	150
SB LT	B	B	B	12.9	13.9	12.2	50	50	75	
SB THRU	B	B	B	17.1	19.6	15.2	275	200	250	400
SB RT	A	A	A	6.7	9.0	8.3	125	125	200	
NC 86 & N. Columbia St / North Street	B	B	C	11.6	19.6	23.4				
WB LT-THRU-RT	E	E	E	56.5	63.0	70.5	50	150	275	150
NB LT	A	B	B	4.1	11.7	12.7	m25	m50	m25	
NB THRU	A	B	B	3.2	10.1	13.1	50	100	m175	150
SB LT	A	B	B	9.6	13.1	19.1	75	75	75	
SB THRU	A	B	E	9.5	12.5	16.8	225	200	275	125
EB LT-THRU-RT	E	E	E	57.4	63.3	75.4	100	125	200	
North Street & Proposed Parking Deck Full Movement Access	N/A	N/A	N/A	N/A	N/A	N/A				
WB LT-THRU	A	A	A	0.0	0.0	0.0	0	0	0	150
NB LR-RT	A	A	B	8.9	9.3	10.0	0	25	25	
E. Rosemary St & Deck Single Access Dr	N/A	N/A	N/A	N/A	N/A	N/A				
EB LT	A	A	A	8.4	8.2	8.1	25	25	25	150
SB LT	B	C	C	13.8	15.2	15.2	25	25	25	50
SB RT	B	B	B	10.4	10.9	11.2	25	25	25	50
E. Rosemary Street & Henderson Street	A	B	B	9.3	12.5	12.5				
EB LT	A	A	A	6.0	6.1	6.8	m25	m25	m25	75
EB THRU-RT	A	A	A	5.6	5.9	8.2	100	100	225	
WB LT-THRU-RT	A	A	A	5.6	6.1	5.7	100	125	125	225
NB LT-THRU-RT	C	D	C	27.6	35.3	30.2	100	75	50	
SB LT-THRU-RT	C	C	C	23.5	22.7	27.9	50	50	75	250
SB THRU-RT	C	C	C	23.5	22.7	27.9	50	50	75	
E. Rosemary Street & Hillsborough Street	B	B	B	15.2	15.7	17.8				
EB LT-THRU-RT	C	C	C	29.2	33.6	32.6	100	125	150	100
WB LT-THRU-RT	C	C	C	29.0	21.9	28.0	100	50	125	
NB LT	A	A	A	3.1	6.3	6.3	25	75	75	100
NB THRU-RT	A	A	A	2.4	5.6	6.9	25	100	150	
SB LT	B	B	B	10.9	12.8	15.5	25	25	50	100
SB THRU-RT	B	B	B	13.5	14.5	16.3	225	150	150	
W. Franklin Street & Church Street	A	B	B	7.7	13.0	18.8				
EB LT	A	A	B	5.0	7.8	12.7	25	50	50	150
EB THRU-RT	A	A	B	6.5	9.3	13.8	125	200	275	
WB LT	A	A	B	2.1	8.3	10.0	m25	m50	m25	200
WB THRU-RT	A	B	B	3.9	10.7	17.9	50	350	m350	
NB LT-THRU	B	B	C	19.7	18.5	20.2	25	25	75	100
NB RT	C	B	B	20.2	18.6	18.7	25	25	50	
SB LT-THRU-RT	C	C	D	25.4	32.3	36.2	75	75	125	

Intersections / Movements	LOS			Average Vehicular Delay (sec/veh)			95 th % Queue Length (Ft)			Future Storage (Ft)
	AM	Noon	PM	AM	Noon	PM	AM	Noon	PM	
E. Franklin Street & Henderson Street	A	B	B	8.0	12.3	12.0				
EB LT-THRU	A	A	A	6.8	6.8	9.0	175	175	m175	N/A
WB THRU-RT	A	A	A	4.7	7.8	5.5	25	150	150	
SB LT-RT	C	D	D	28.7	36.0	40.3	75	125	150	
Cameron Ave/Country Club Rd & Raleigh	C	C	C	23.1	20.9	30.6				
EB LT-THRU-RT	C	C	D	22.4	25.4	35.4	100	125	225	150
WB LT	B	B	B	12.6	13.7	15.3	25	25	50	
WB THRU-RT	C	C	C	25.0	22.8	26.1	250	175	275	125
NB LT	B	B	B	14.5	12.5	17.7	25	25	75	
NB THRU-RT	C	C	D	31.7	30.1	43.3	75	100	175	75
SB LT	C	B	C	21.7	14.8	25.9	#225	150	#225	
SB THRU-RT	C	B	C	21.8	19.1	33.1	175	125	275	
Franklin Street & NC 86 (Columbia Street)	C	D	E	30.2	40.7	60.6				
EB LT	E	E	F	78.1	76.0	161.0	125	150	#375	250
EB THRU-RT	C	C	D	23.9	32.9	36.5	150	225	325	
WB LT	E	F	F	79.6	83.9	93.9	125	150	175	125
WB THRU	C	D	F	22.8	40.0	92.0	#175	#500	#785	
WB RT	A	B	C	9.1	13.9	21.6	25	75	75	475
NB LT	F	F	F	82.3	100.0	100.2	m50	125	m75	
NB THRU-RT	C	C	C	20.7	28.6	24.2	150	75	m175	125
SB LT	F	F	F	91.3	90.6	127.0	75	100	m#175	
SB THRU-RT	C	C	D	26.8	32.1	47.5	100	100	#375	
E. Franklin St & Hillsborough/Raleigh St	C	C	C	22.5	24.0	21.4				
EB LT	B	B	A	14.3	13.9	6.2	25	75	m25	75
EB THRU-RT	B	B	A	13.6	11.6	5.1	100	175	100	
WB LT	C	B	B	22.7	14.8	12.9	75	50	75	75
WB THRU-RT	C	B	B	21.5	14.2	13.1	225	200	350	
NB LT-THRU-RT	D	D	E	35.3	53.3	78.8	225	300	350	100
SB LT	B	C	D	16.6	32.4	40.5	75	100	75	
SB THRU-RT	C	D	D	25.8	41.1	44.1	250	225	225	
NC 86 (MLK Jr. Blvd) & Longview Street	A	A	A	9.6	5.6	8.1				
EB LT-THRU-RT	B	B	C	18.7	12.8	20.7	50	50	100	225
WB LT-THRU-RT	B	B	B	12.8	10.8	17.4	25	25	50	
NB LT	A	A	A	6.0	5.4	5.7	25	25	25	250
NB THRU-RT	A	A	A	7.2	5.1	7.5	75	75	150	
SB LT	A	A	A	0.0	5.0	5.9	0	25	25	100
SB THRU-RT	A	A	A	9.2	5.1	6.4	125	75	125	
W. Cameron Ave & NC 86 (Pittsboro St)	B	C	C	17.4	20.3	20.3				
EB THRU-RT	C	C	D	28.6	21.4	47.5	175	200	450	75
WB LT	B	C	B	14.4	27.4	13.6	200	250	m125	
WB THRU	A	A	A	6.0	3.8	1.6	m100	m75	m50	
Cameron Ave & NC 86 (S. Columbia St)	C	C	E	28.4	33.4	56.9				
EB LT	D	D	C	35.9	38.0	24.8	m25	m50	m25	100
EB THRU	D	C	C	41.1	33.7	21.1	m125	100	m125	
WB THRU-RT	E	E	F	62.5	70.1	93.4	150	175	#400	300
NB LT	C	C	D	28.4	23.4	42.9	125	175	275	
NB LT-THRU-RT	C	C	F	33.0	23.9	83.8	250	225	#575	100
SB LT	A	B	B	7.1	19.0	17.7	m25	m50	m125	
SB RT	B	D	C	16.7	36.7	26.8	325	275	350	

N/A – Not Applicable, i.e. movement is non-existent or overall intersection values are not reported for unsignalized intersections
BOLD/ITALICS – Movement or overall intersection is over Town TIS Guidelines threshold capacity **GREEN** – Recommended Improvement
PURPLE – Maximum Queue May Exceed Storage Bay Distance m – Volume for 95th percentile queue is metered by upstream signal
 # – 95th percentile volume exceeds capacity, queue may be longer (queue shown is maximum after 2 cycles)



Table 14. Capacity Analysis Results for Study Area Intersections Condition 6 – 2023 Traffic With Office Building

Intersections / Movements	LOS			Average Vehicular Delay (sec/veh)			95 th % Queue Length (Ft)			Future Storage (Ft)
	AM	Noon	PM	AM	Noon	PM	AM	Noon	PM	
W. Rosemary Street & Church Street	A	A	B	9.6	9.5	13.7				
EB LT-THRU-RT	A	A	B	6.1	6.3	10.1	125	150	225	N/A
WB LT-THRU-RT	A	A	A	3.7	2.5	5.3	100	50	m100	
NB LT-THRU-RT	C	C	D	25.2	32.4	37.0	75	75	m100	
SB LT-THRU-RT	C	C	C	26.1	25.8	26.6	75	50	100	
W. Rosemary Street & NC 86	C	C	D	24.5	27.5	40.7				
EB LT	D	C	F	38.8	30.1	129.8	150	150	#400	100
EB THRU-RT	C	C	D	34.3	27.6	44.5	250	250	425	150
WB LT	D	D	E	38.4	44.9	78.4	50	125	#225	
WB THRU-RT	E	E	F	60.5	57.9	120.9	225	#450	#525	75
NB LT	B	B	A	13.0	16.6	5.5	m25	m50	m25	
NB THRU-RT	B	C	B	15.6	20.9	11.4	125	150	m75	150
SB LT	B	B	B	13.2	14.6	12.7	50	50	m50	
SB THRU	B	B	B	17.1	19.5	15.4	150	100	125	400
SB RT	A	A	A	6.7	8.9	8.3	50	50	50	
North Street & Proposed Parking Deck Full Movement Access	N/A	N/A	N/A	N/A	N/A	N/A				
WB LT-THRU	A	A	A	0.0	0.0	0.0	0	0	0	150
NB LR-RT	A	A	B	8.9	9.3	10.0	0	25	25	
NC 86 & N. Columbia St / North Street	B	B	C	11.6	19.4	23.8				
WB LT-THRU-RT	E	E	E	56.5	63.0	70.5	50	150	275	150
NB LT	A	B	B	4.5	11.3	13.6	m25	m50	m25	
NB THRU	A	A	B	3.4	9.7	14.3	50	125	m175	150
SB LT	A	B	B	9.6	13.1	19.6	75	75	75	
SB THRU	A	B	B	9.6	12.6	16.9	225	200	300	150
EB LT-THRU-RT	E	E	E	57.4	63.3	75.4	100	125	175	
E. Rosemary St & Deck Single Access Dr	N/A	N/A	N/A	N/A	N/A	N/A				
EB LT	A	A	A	8.5	8.3	8.3	25	25	25	150
SB LT	C	C	C	19.3	15.9	16.1	25	25	25	50
SB RT	B	B	B	10.4	11.2	12.0	25	25	25	50
E. Rosemary St & Office Driveway West	N/A	N/A	N/A	N/A	N/A	N/A				
WB LT	A	A	A	7.9	8.1	8.4	0	0	0	100
NB LT-RT	B	B	B	12.8	12.4	13.8	25	25	25	50
E. Rosemary St & Office Driveway East	N/A	N/A	N/A	N/A	N/A	N/A				
WB LT	A	A	A	7.8	8.1	8.5	25	0	0	50
NB LT-RT	B	B	B	10.7	11.7	13.3	25	25	25	50
E. Rosemary Street & Henderson Street	B	B	B	10.1	13.3	12.6				
EB LT	A	A	A	6.6	6.7	7.1	m25	m25	m25	75
EB THRU-RT	A	A	A	6.1	6.8	9.0	100	150	200	
WB LT-THRU-RT	A	A	A	6.1	6.7	5.9	100	125	125	75
NB LT-THRU-RT	C	D	C	29.3	36.5	29.3	100	75	50	
SB LT-THRU-RT	C	C	C	21.7	21.5	27.0	50	50	75	
E. Franklin Street & Henderson Street	A	B	B	7.7	13.1	12.9				
EB LT-THRU	A	A	A	6.8	7.2	9.4	175	175	m175	N/A
WB THRU-RT	A	A	A	3.9	8.8	6.0	25	175	175	
SB LT-RT	C	D	D	29.4	35.8	42.1	75	150	150	

Intersections / Movements	LOS			Average Vehicular Delay (sec/veh)			95 th % Queue Length (Ft)			Future Storage (Ft)
	AM	Noon	PM	AM	Noon	PM	AM	Noon	PM	
E. Rosemary Street & Hillsborough Street	B	B	B	15.2	15.7	17.5				
EB LT-THRU-RT	C	C	C	29.6	32.7	30.3	100	125	125	100
WB LT-THRU-RT	C	C	C	28.4	21.4	25.6	100	50	100	
NB LT	A	A	A	3.3	6.4	6.9	25	75	75	
NB THRU-RT	A	A	A	2.4	5.6	7.6	25	75	175	
SB LT	B	B	B	11.0	13.0	16.2	25	25	50	100
SB THRU-RT	B	B	B	13.9	14.9	17.2	225	150	150	
W. Franklin Street & Church Street	A	B	B	7.7	13.4	19.1				
EB LT	A	A	B	5.1	8.0	13.2	25	50	50	150
EB THRU-RT	A	A	B	6.6	9.5	14.0	125	200	275	
WB LT	A	A	B	1.9	8.8	10.1	m25	m50	m25	200
WB THRU-RT	A	B	B	3.7	11.6	18.1	m50	375	m350	
NB LT-THRU	B	B	C	19.6	18.3	20.1	25	25	75	100
NB RT	C	B	B	20.2	18.5	18.6	25	25	50	
SB LT-THRU-RT	C	C	D	25.6	32.4	36.6	75	75	125	
Cameron Ave/Country Club Rd & Raleigh	C	C	C	23.7	21.0	30.8				
EB LT-THRU-RT	C	C	D	22.0	25.4	35.5	100	125	225	150
WB LT	B	B	B	12.5	13.7	15.3	25	25	50	
WB THRU-RT	C	C	C	25.4	23.2	26.5	250	175	275	125
NB LT	B	B	B	15.1	12.5	17.7	25	25	75	
NB THRU-RT	C	C	D	32.4	30.2	43.3	75	100	175	75
SB LT	C	B	C	22.8	15.1	26.8	#250	150	#250	
SB THRU-RT	C	B	C	22.5	19.1	33.0	175	125	275	
Franklin Street & NC 86 (Columbia Street)	C	D	E	30.5	41.0	59.4				
EB LT	F	E	F	80.1	75.2	166.2	125	150	#375	250
EB THRU-RT	C	C	D	24.0	33.6	36.7	150	225	325	
WB LT	E	F	F	78.9	82.5	93.2	125	150	175	125
WB THRU	C	D	F	23.7	42.1	91.8	#175	#525	#800	
WB RT	A	B	C	9.3	15.9	21.7	25	100	m75	475
NB LT	F	F	F	83.6	100.2	102.0	m50	125	m75	
NB THRU-RT	C	C	B	20.9	28.2	18.6	175	75	m75	125
SB LT	F	F	F	92.6	88.5	124.5	75	100	m#175	
SB THRU-RT	C	C	D	26.6	32.2	48.0	100	100	#400	
E. Franklin St & Hillsborough/Raleigh St	C	C	C	22.5	23.7	21.6				
EB LT	B	B	A	15.5	15.4	6.6	25	75	m25	75
EB THRU-RT	B	B	A	14.8	12.8	5.5	100	175	150	
WB LT	C	B	B	24.9	16.0	13.5	75	50	75	75
WB THRU-RT	C	B	B	24.0	15.5	13.5	250	225	350	
NB LT-THRU-RT	C	D	E	31.5	49.3	76.2	225	300	350	100
SB LT	B	C	D	15.4	30.1	42.4	75	100	100	
SB THRU-RT	C	D	D	23.5	37.7	44.4	225	200	225	

N/A – Not Applicable, i.e. movement is non-existent or overall intersection values are not reported for unsignalized intersections
BOLD/ITALICS – Movement or overall intersection is over Town TIS Guidelines threshold capacity
GREEN – Proposed/Recommended Improvement **PURPLE** – Maximum Queue May Exceed Storage Bay Distance
 m – Volume for 95th percentile queue is metered by upstream signal
 # – 95th percentile volume exceeds capacity, queue may be longer (queue shown is maximum after 2 cycles)



**Table 14. (Continued) Capacity Analysis Results for Study Area Intersections
 Condition 6 – 2023 Traffic With Office Building**

Intersections / Movements	LOS			Average Vehicular Delay (sec/veh)			95 th % Queue Length (Ft)			Future Storage (Ft)
	AM	Noon	PM	AM	Noon	PM	AM	Noon	PM	
NC 86 (MLK Jr. Blvd) & Longview Street	A	A	A	9.7	5.6	8.1				
EB LT-THRU-RT	B	B	C	19.5	12.8	21.1	50	50	100	225
WB LT-THRU-RT	B	B	B	13.3	11.0	17.7	25	25	50	
NB LT	A	A	A	6.0	5.4	5.6	25	25	25	
NB THRU-RT	A	A	A	7.1	5.1	7.5	75	75	175	
SB LT	A	A	A	0.0	5.0	5.9	0	25	25	
SB THRU-RT	A	A	A	9.2	5.1	6.3	125	75	125	
W. Cameron Ave & NC 86 (Pittsboro St)	B	C	C	17.5	20.5	20.1				
EB THRU-RT	C	C	D	28.7	21.5	47.5	175	200	450	75
WB LT	B	C	B	14.4	27.7	13.4	200	275	m125	
WB THRU	A	A	A	6.1	3.9	1.8	m100	m75	m50	
Cameron Ave & NC 86 (S. Columbia St)	C	C	E	28.7	33.7	64.1				
EB LT	D	D	C	36.3	38.8	24.8	m25	m50	m25	100
EB THRU	D	C	C	41.0	33.8	21.1	m125	100	m125	
WB THRU-RT	E	E	F	62.5	70.1	93.4	150	175	#400	
NB LT	C	C	D	28.5	23.6	46.0	125	175	300	
NB LT-THRU-RT	C	C	F	33.9	24.3	103.8	275	225	#600	
SB LT	A	B	B	7.0	18.8	16.0	m25	m50	m100	
SB RT	B	D	C	16.6	37.2	25.5	325	275	350	

N/A – Not Applicable, i.e. movement is non-existent or overall intersection values are not reported for unsignalized intersections

BOLD/ITALICS – Movement or overall intersection is over Town TIS Guidelines threshold capacity

PURPLE – Maximum Queue May Exceed Storage Bay Distance

m – Volume for 95th percentile queue is metered by upstream signal

– 95th percentile volume exceeds capacity, queue may be longer (queue shown is maximum after 2 cycles)

viii.) 2023 Build Scenario With Recommended Office Parking Access (Condition 7) Results

Table 15 presents results for 2023 Build-out+1 year estimated traffic conditions, including impacts of estimated proportions of Office site-related traffic assigned to the on-site parking facility modified for the following access change:

- One primary full movement access location on E. Rosemary Street located approximately 225 feet west of the Henderson Street intersection. Parking deck exit to have single shared left-turn/right-turn exit lane.

This scenario also analyzed a potential improvement to the NC 86 and N. Columbia Street/North Street intersection for a westbound right-turn lane on North Street. The primary effect of the turn lane would be a reduction in overall approach delay and reduction in projected queues at this location.



These possibilities are highlighted in **Figure 2B**. A recommended improvement related to managing access and potentially improving safety along E. Rosemary Street would be to provide a single, main access driveway for the on-site underground parking along E. Rosemary Street that would maximize driveway and intersection separation distances between the proposed new parking deck and the Henderson Street intersection.

Pedestrian and Bicycle

Access for pedestrians and bicycles has excellent existing connectivity in the project study area. Sidewalk is present along both sides of most downtown Chapel Hill streets, with signalized crosswalks at all quadrants at most intersections. The provision of a pedestrian bridge connection between the proposed deck and commercial development on the south side of E. Rosemary Street as is currently provided in the existing parking deck would eliminate conflicts with traffic for pedestrians seeking destinations in that block of downtown and beyond. Bicycle lanes are present W. Rosemary Street west of the site and bike “sharrows” are delineated on E. Rosemary Street adjacent to the site and along NC 86 to the north of the site.

C. Signal Warrant Analysis

Based on projected 2023 traffic volumes with both sites completely built-out and proposed access plans, no unsignalized intersection in the project study area would warrant the installation of a traffic signal, based on the methodology found in the *2009 Manual on Uniform Traffic Control Devices (MUTCD)*.

The stop-controlled approaches at the intersection of NC 86 (Martin Luther King, Jr. Blvd) and North Street / N. Columbia Street are expected to operate at a PM peak hour LOS F in the 2023 analysis year with parking deck and office building site traffic added. 2023 peak hour volumes, and existing geometrics were analyzed for meeting the Peak Hour Warrant in the 2009 MUTCD and HCS 7 Warrants software package. The results shown in **Appendix G** indicate that the NC 86 (Martin Luther King, Jr. Blvd) and North Street / N. Columbia Street intersection would warrant the installation of a traffic signal, given the anticipated minor street approach volumes during the PM peak hour. Even considering the fact that the minor street approaches feature a disproportionate number of right-turning vehicles that have less effect on the need for a signal to provide adequate gaps in the major traffic stream and thus by reducing the right-turn volumes by 50% for this analysis, the intersection still met the Peak Hour Warrant in the PM peak hour. Satisfaction of additional warrants would be needed to justify the implementation of a traffic signal at this location. The intersection is recommended to be monitored for signalization in the event that future traffic volumes (with the completion of the parking deck and office building projects) meet signal warrants.

D. Sight Distance Analysis

In general, geometric sight distance issues entering/exiting the proposed East Rosemary Parking Deck or proposed Office Building driveways would be minimal, considering the fact that E. Rosemary Street has no horizontal curvature in the vicinity of the proposed access locations and vertical curvature along E. Rosemary Street in this vicinity is minimal or is in/near a sag vertical curve. Combined with low posted speeds (20 mph on E. Rosemary Street), the roadway alignment and access locations give entering and exiting traffic adequate sight distance in both directions. In the modified parking deck access scenario, sight distance at the proposed exit-only driveway along NC 86 (N. Columbia Street) is acceptable, as the section of NC 86 (N. Columbia Street) in this vicinity has no horizontal curvature. Upstream of a potential driveway location, there is limiting vertical curvature at the Rosemary Street intersection, but traffic entering the intersection is traveling under lower speed (20 mph posted) conditions, which should allow for adequate recognition of gaps to make right-turns onto NC 86 northbound. For the potential ingress proposed on NC 86 (Martin Luther King, Jr. Blvd) at North Street) the southbound center left-turn lane



that would be utilized for this access has adequate sight distance for opposing through northbound traffic on NC 86, as this traffic stream has no horizontal curvature and little vertical curvature that would obstruct turning movements.

E. Crash Analysis

Data from the NCDOT Traffic Safety Unit TEAAS crash software database was extracted for the five year period from 3/1/2015 to 2/29/2020 for the segment of E. Rosemary Street from NC 86 to Henderson Street and for the segment of NC 86 from Franklin Street to Stephens Street. Individual intersection crash analyses were also compiled for NC 86 and Rosemary Street, NC 86 and N. Columbia Street/North Street and E. Rosemary Street and Henderson Street. Raw crash data can be found in **Appendix H**.

E. Rosemary Street Corridor

There were 34 crashes reported along the E. Rosemary Street study area corridor between NC 86 and the Henderson Street over the five year period. In this 0.18 mile segment, crash types were primarily rear end crashes and left-turn/angle crashes. Spatial distribution of crashes from the segment strip map indicates that crashes were distributed with the highest number of intersection crashes (21) occurring in the vicinity of the E. Rosemary Street intersection with NC 86. Several crashes occurred in the vicinity of the existing parking lot/deck entrance/exits. Six crashes occurred near the Henderson Street intersection.

Table 16 presents a comparison between the E. Rosemary Street study area crash rates and the latest North Carolina statewide rates for the period 2015-2017 (compiled by NCDOT Traffic Safety Unit). Overall, the crash rates along E. Rosemary Street in the project study area are far higher than statewide averages for similar urban secondary roadway facilities (two-lane undivided with continuous center turn lane) in every reported category, except for fatal crashes. The data is somewhat skewed by the short distance of the segments and the high crash numbers focused at the NC 86 intersection.

NC 86 Corridor

There were 60 crashes reported along the NC 86 study area corridor between Franklin Street and Stephens Street over the five year period. In this 0.33 mile segment, primary crash types were rear-end crashes, angle/left-turn crashes and sideswipes. There was one crash involving a pedestrian and one crash involving a bicyclist along this segment of NC 86. Spatial distribution of crashes along the corridor from the segment strip map indicates that a majority of crashes were centered at, or between, the Franklin Street and Rosemary Street intersections (44 of 60 total crashes). The North Street intersection experienced seven crashes.

Table 16. Study Area Crash Rate Comparison – E. Rosemary Street Corridor

Statistic	Crashes Per 100 Million Vehicle Miles	
	E. Rosemary Street	NC Statewide Average*
	NC 86 to Henderson Street	2-Lane with Continuous Left-Turn Lane
Total Crash Rate	1,393.99	318.88
Fatal Crash Rate	0.00	1.08
Non-Fatal (Injury) Crash Rate	205.00	94.22
Night Crash Rate	369.00	76.64
Wet Pavement Crash Rate	164.00	49.98

* - Data for Urban Secondary Routes



Table 17 presents a comparison between the NC 86 study area crash rates and the latest North Carolina statewide rates for the period 2015-2017 (compiled by NCDOT Traffic Safety Unit). Overall, the crash rates along NC 86 in the project study area are lower than statewide averages for similar urban secondary roadway facilities (two-lane undivided) in every reported category, except for wet pavement crashes – although the sample number of crashes and relatively low daily traffic volume on NC 86 contribute heavily to the high crash rate for this category.

Table 17. Study Area Crash Rate Comparison – NC 86 Corridor

Statistic	Crashes Per 100 Million Vehicle Miles	
	NC 86 Franklin Street to Stephens Street	NC Statewide Average* 5-Lane Undivided with TWLTL
Total Crash Rate	578.39	299.06
Fatal Crash Rate	0.00	1.39
Non-Fatal (Injury) Crash Rate	106.04	83.67
Night Crash Rate	154.24	58.08
Wet Pavement Crash Rate	96.40	44.6

* - Data for Urban NC Routes

Study Area Intersections

In addition to the crash comparison for the NC 86 and E. Rosemary Street project study corridors, individual intersection crash data in the vicinity of the proposed parking deck site for the same five year period was provided by NCDOT and results are shown in **Table 18**. The crash data also reveals that the Rosemary Street & NC 86 (N. Columbia Street) intersection suffers from a high number and rate of crashes. 16 of the 42 crashes occurred with the initial/primary vehicle heading southbound on NC 86 at this location. The intersection of NC 86 and North Street/N. Columbia Street has a low rate of crashes but 4 of the 11 reported crashes at this location were injury crashes.

Table 18. Study Area Intersection Crash Summary

Intersection	Total Crashes	Crashes Per 100 Million Vehicles Entered
NC 86 (N. Columbia Street) & Rosemary Street	42	93.83
NC 86 (MLK Jr. Blvd) & North St / N. Columbia St	11	31.69
E. Rosemary Street & Henderson Street	11	70.83

F. Other Transportation-Related Analyses

Other transportation-related analyses relevant to the 2001 Town of Chapel Hill Guidelines for the preparation of Traffic Impact Studies were completed as appropriate. The following topics listed in **Table 19** are germane to the scope of this study.

G. Special Analysis/Issues Related to the Projects

Based on discussions with Town of Chapel Hill staff, this study is the second of two traffic impact studies related to the overall redevelopment of existing parking facilities along E. Rosemary Street. The first study, completed in April 2020, focused on the redevelopment of the existing Rosemary Parking Deck and adjacent surface street lot into a new 1,100 space parking deck. The impacts of the new deck and initial recommendations from the first study were carried over to this document, with the new office



building impacts added. It was assumed for the purposes of this overall study that the proposed office building would not be constructed without the parking deck project being constructed and being constructed prior to the office building.

Table 19. Other Transportation-Related Analyses

Analysis	Comment
Turn Lane Storage Requirements	<p>Storage bay lengths at study area intersections were analyzed using Synchro and HCM 95th percentile (max) queue length estimates for all analyzed scenarios. Additional SimTraffic microsimulation runs were completed for the 2023 With Parking Deck and Office Building Scenario to validate the recommended proposed access recommendations for both sites. The original parking deck access concept’s western access point on E. Rosemary would likely be blocked by westbound queues on E. Rosemary Street at the NC 86 intersection. The North Street access scenario removes some site-related traffic from E. Rosemary Street, thus reducing queue lengths. Providing a single access point for the deck farther to the east of the NC 86 intersection provide adequate separation to manage left-turn queues and avoid deck access blockage. Additional traffic related to the proposed Office Building to the E. Rosemary Street corridor adds more justification for this recommendation.</p> <p>There are several intersections in the study area that are currently near capacity and are expected to continue to be in the 2022 and 2023 analysis years where one or multiple left-turn storage bays do not provide adequate storage to accommodate existing or projected maximum peak hour queues. As roadway capacity improvements in these situations would generally be difficult, given current right-of-way constraints in the downtown and UNC Main Campus area, and the fact that the proposed parking deck and office building are expected to marginally contribute to queuing issues beyond the immediate intersections adjacent to the site, no additional recommendations were made for turn lane storage requirements for this study</p>
Appropriateness of Acceleration/ Deceleration Lanes	<p>The site concept plans do not show any provision for additional acceleration or deceleration lanes. With the proposed site located in the downtown Chapel Hill central business district, most area roadways have low posted speeds and do not require additional acceleration/deceleration lanes. E. Rosemary Street has a three-lane cross section with center left-turn lane that will provide separation for turning traffic into the proposed parking deck and office building sites. The modified parking deck access scenario also utilizes the center left-turn lane along NC 86 for safe separation of turning traffic onto North Street from the southbound through travel lanes.</p>
Pedestrian and Bicycle Analysis	<p>Existing pedestrian access and connectivity is currently well implemented throughout the downtown Chapel Hill area that would be served by the proposed deck and office building. Consideration should be made to continue to provide a pedestrian overpass connection to development south of E. Rosemary Street adjacent to the proposed deck (possibly including the proposed office building), as is currently provided. A mid-block delineated pedestrian crossing for the parking deck, with raised central median on E. Rosemary Street, would also reduce likelihood of jay-walking from the deck to the south side of the street. Bicycle facilities (bike lanes and roadway “sharrows” and activity are prevalent in the downtown area as well and the proposed deck design could incorporate opportunities for bicycle parking convenient to E. Rosemary Street frontage.</p>



IV. MITIGATION MEASURES / RECOMMENDATIONS

A. Planned Improvements

There are no planned transportation improvement projects by NCDOT expected to be complete between 2020 and 2023 in the immediate project study area. The Town of Chapel Hill is in the process of designing and implementing the West Franklin Street Lane Reallocation project to reduce the number of through travel lanes on West Franklin Street west of NC 86. The reallocated lanes will be used for parking, loading zones, bicycle lanes and other amenities. This project was expected to be complete by the 2022 analysis year and was also assumed to include signal retiming throughout the downtown area to account for vehicular flow changes in the lane reallocation vicinity. Details are shown on **Figure 16**.

The Town also has the North-South Bus Rapid Transit Project, which will provide dedicated lanes for transit along the NC 86 corridor, along with other transit amenity improvements scheduled for construction in 2022. As final design details are not complete as of the submittal of this TIA, no specific lane usage changes were analyzed as part of this study.

B. Background Committed Improvements

There are no specific transportation network improvements to study area roadway intersections related to background private development projects that are expected to be completed between 2020 and 2023.

C. Applicant Committed Improvements

Based on the preliminary site concept plans and supporting development information provided, there are no specific transportation-related improvements proposed external to the East Rosemary Parking Deck or Office Building sites. The current plans and preliminary deck design incorporate two full movement access points along E. Rosemary Street only, with single lane entry/exits to the deck. Additional information from the Applicant indicated a desire to allow a full access connection from the proposed parking deck to North Street, which was included in the analysis of 2022 Build and 2023 No-Build and Build Scenarios.

There are currently no specific conceptual plan designs for the Office Building parking deck access points or internal/external assumed circulation. Per agreement with the Applicant, two access points were assumed along E. Rosemary Street, with no direct access to Henderson Street and retaining the possibility of providing access from the rear of the building to the existing alley that will continue to have ingress and egress access connections with E. Rosemary Street.

D. Necessary Improvements

Parking Deck

Based on traffic capacity analyses for the 2022 design year, and analyses of existing study area turning bay storage lengths and site access, the following improvements are recommended as being necessary for adequate transportation network operations (see **Figure 16A**).

- 1) To reduce potential conflicts and provide better separation for left-turning vehicles along E. Rosemary Street approaching the NC 86 intersection westbound and the parking deck eastbound, eliminate the currently proposed western deck access location and provide a single primary deck access location where the current eastern deck access is proposed. At this primary access point, provide separate left-turn and right-turn exit lanes. Depending on method of parking deck space management (gates/ticketing), provide adequate internal queue storage for entry flows that may



reach 200 vehicles in a single hour. This improvement is recommended for the East Rosemary Parking Deck development.

- 2) Due to potential peak hour queuing issues for the westbound left-turn and through travel lanes at the E. Rosemary Street intersection with NC 86 (N. Columbia Street), reoptimize the traffic signal timings to allow adequate green time to reduce westbound queuing for this movement in all peak hours. This improvement is recommended for the East Rosemary Parking Deck development.
- 3) To reduce site-related traffic volumes at the critical E. Rosemary Street intersection with NC 86, provide alternate access using North Street to connect to a two-way inbound/outbound parking deck connection. This should remove most parking deck related traffic flow to/from the NC 86 corridor north of the site. A full access connection may add some site-related traffic that may cut-through the North Street neighborhood and potentially additional traffic calming measures may be needed to reduce as much cut-through traffic as possible. It is recommended that a traffic calming study for the segments of North Street to the east of the proposed parking deck access point and Henderson Street between North Street and E. Rosemary Street be conducted after the parking deck is complete and opened to traffic. These improvements are recommended for the East Rosemary Parking Deck development.
- 4) To reduce projected queues along North Street westbound that would include parking deck egress traffic, the provision of a right-turn bay (making the westbound approach a stop-controlled shared left-turn/through lane and right-turn lane) with at least 50 feet of vehicle storage is recommended to reduce overall approach delays and queues at this location. The currently skewed minor street intersection approaches for North Street and N. Columbia Street should be realigned to better align through movements. This intersection also may meet MUTCD Warrants for signalization after the parking deck and office building projects are complete and should be monitored for signalization if operational or safety issues results from the additional traffic produced by the two projects. These improvements are recommended for the East Rosemary Parking Deck development.
- 5) Additional wayfinding signage on external roadways and internal to the proposed parking deck is recommended to fully utilize the proposed North Street and N. Columbia Street access points, as well as identify routes to E. Franklin Street, US 15-501, and NC 54 (make a left-turn exiting the deck) and NC 86 South, Carrboro, Pittsboro (make a right-turn exiting the deck). These improvements are recommended for the East Rosemary Parking Deck development.
- 6) To provide direct, safe, and convenient pedestrian access from the parking deck to commercial developments south of the E. Rosemary Street corridor, it is recommended that a pedestrian overpass be included in the deck design, similar to the existing pedestrian overpass that connects the existing Rosemary Parking Deck. In addition, at street level, a mid-block pedestrian crosswalk, with appropriate signage and potentially a raised median refuge island depending on its location should be included. These improvements are recommended for the East Rosemary Parking Deck development.

Office Building

Based on traffic capacity analyses for the 2023 design year, and analyses of existing study area turning bay storage lengths and Office Building potential site access issues, the following improvements are recommended as being necessary for adequate transportation network operations (see **Figure 16A**). These improvements are made with the assumptions that the 2022 Parking Deck analysis year Necessary Improvements listed above are all completed by the 2023 analysis year for the proposed Office Building.



- 1) To reduce potential conflicts and provide better separation for left-turning vehicles along E. Rosemary Street approaching the parking deck access driveway westbound and Henderson Street eastbound, provide a single primary on-site underground parking garage access location approximately 225 feet west of the Henderson Street intersection and aligning with the current driveway to 151 E. Rosemary. This improvement is recommended for the East Rosemary Office Building development.
- 2) Maintain the existing one-way alley access configuration behind the proposed Office Building. A secondary enter-only access point for vehicles parking beneath the proposed Office Building could be located along the alley, but all structured parking egress should be directly onto E. Rosemary Street at the recommended single primary location described above. Egress should not be permitted for parking garage vehicles along the alley, as additional traffic access to E. Rosemary Street near the Henderson Street intersection may cause operational and safety issues.



Appendix A – Figures

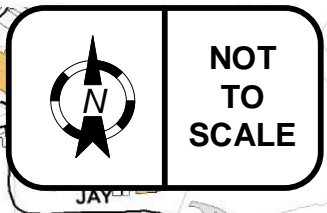

LEGEND

- = Existing Study Area Signalized Intersection
- = Existing Study Area Unsignalized Intersection
- = Existing/Potential Future Parking Access Driveway
- = Proposed Parking Deck Location
- = Proposed Future Office Building Location

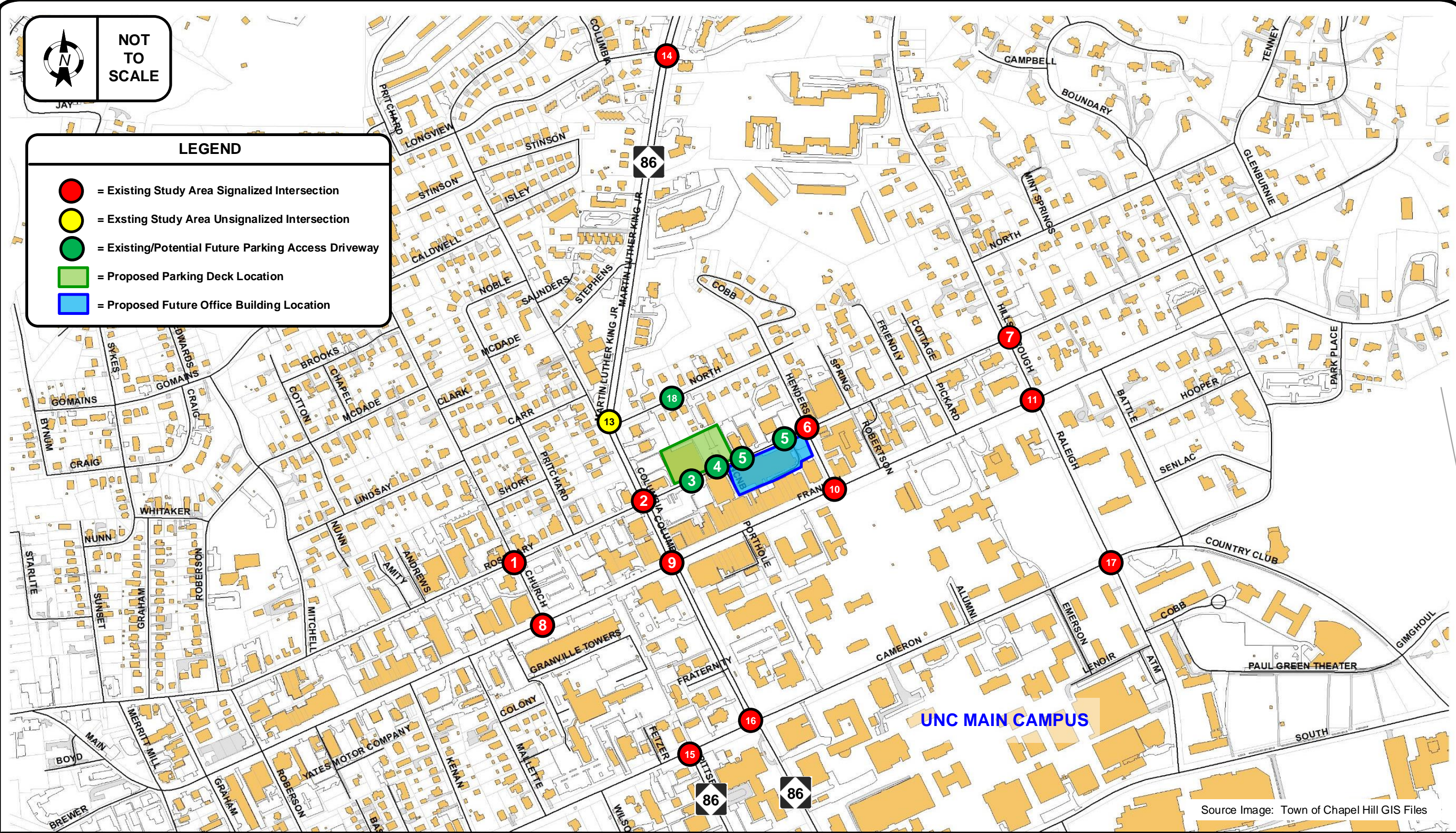

Source Image: Town of Chapel Hill GIS Files



**East Rosemary Street Parking Deck & Office Building
Transportation Impact Analysis**

PROJECT STUDY AREA

DATE: September 2020

FIGURE 1

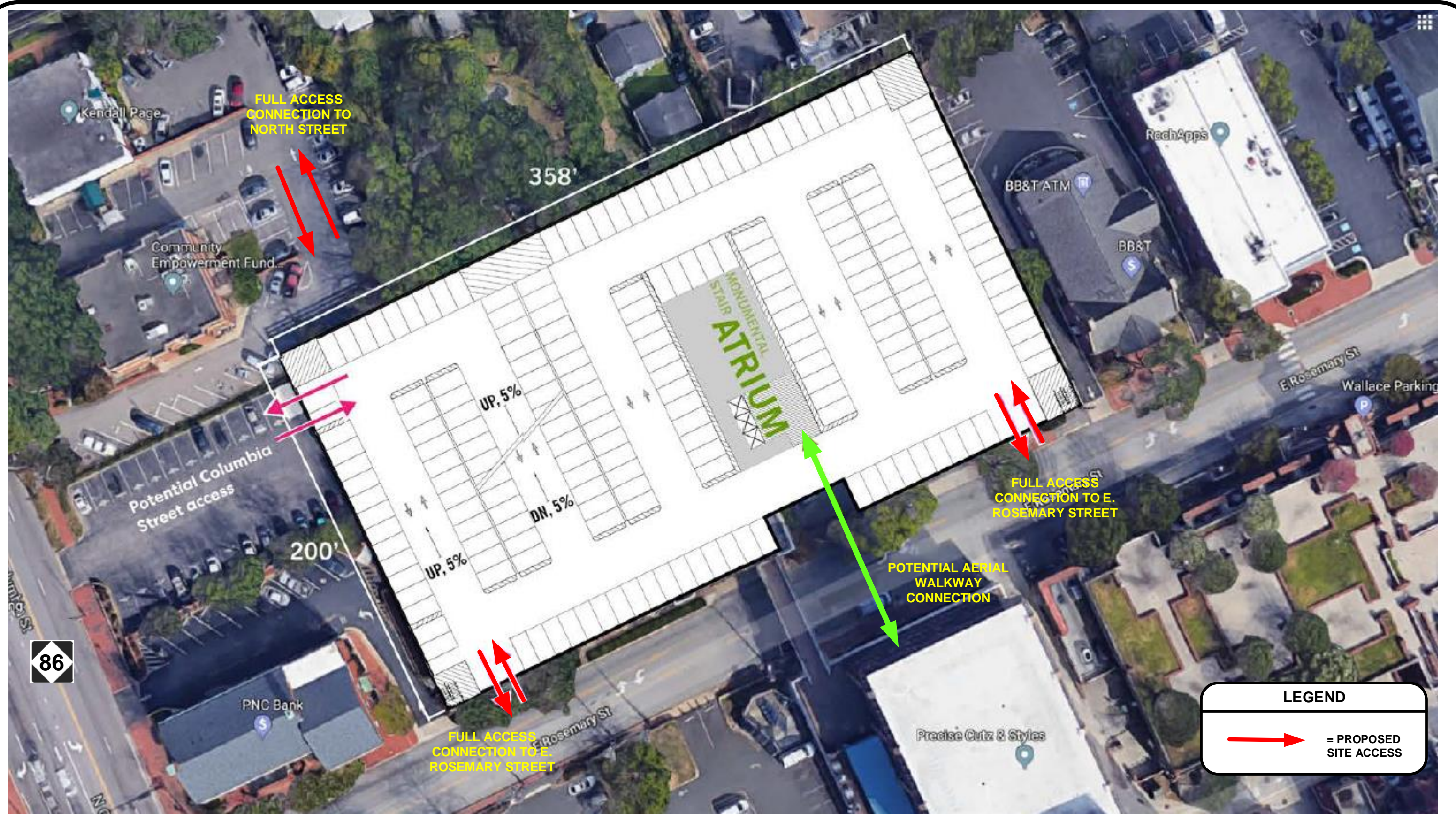

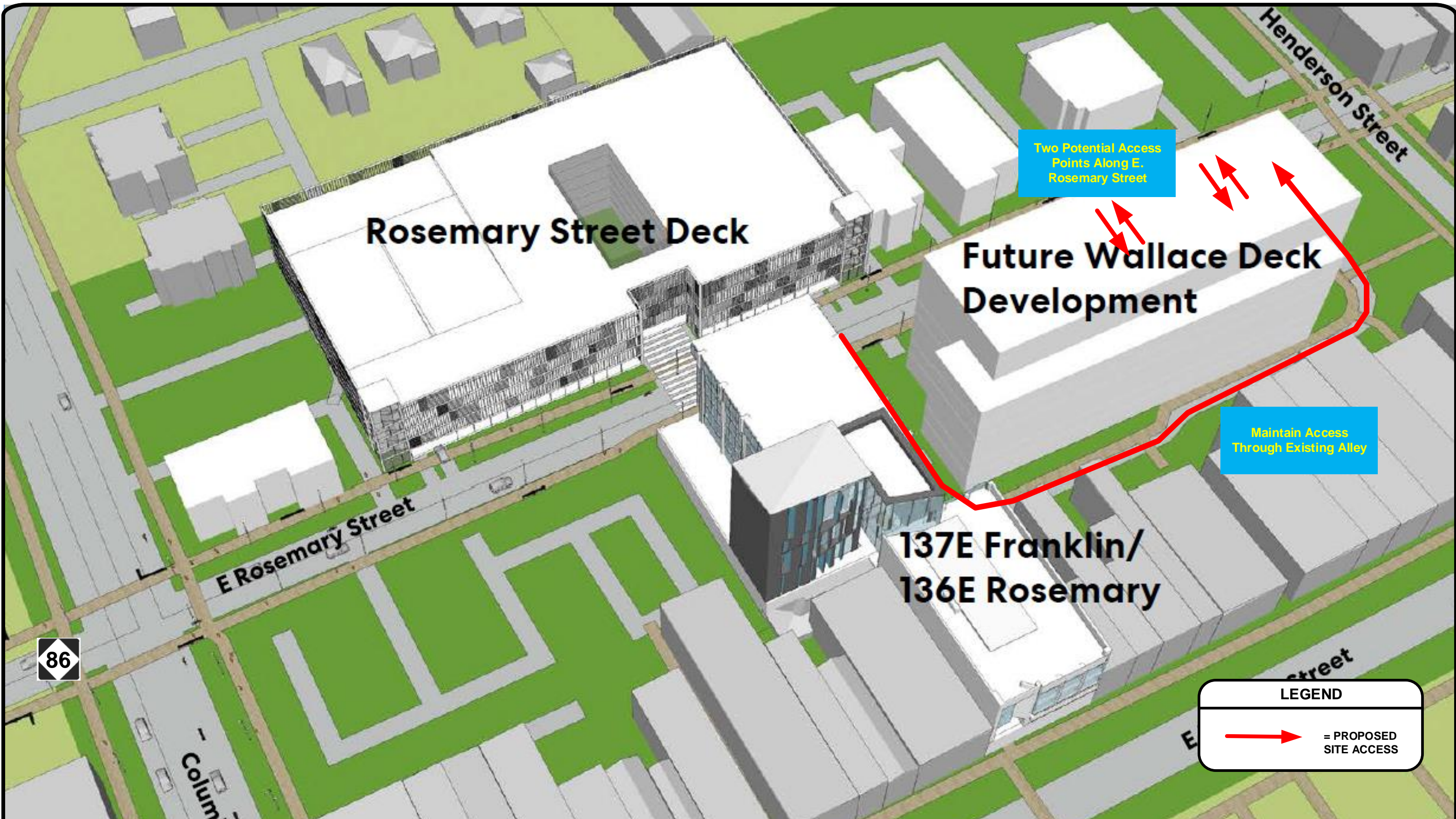

HNTB



NOT TO SCALE

**East Rosemary Street Parking Deck & Office Building
Transportation Impact Analysis**

PRELIMINARY SITE CONCEPT PLAN – OFFICE BUILDING

DATE: September 2020

FIGURE 2B

LEGEND

Geometric, Speed Limits and Traffic Control As Shown

XXX' = Storage Bay Length
CTL = Continuous Turn Lane

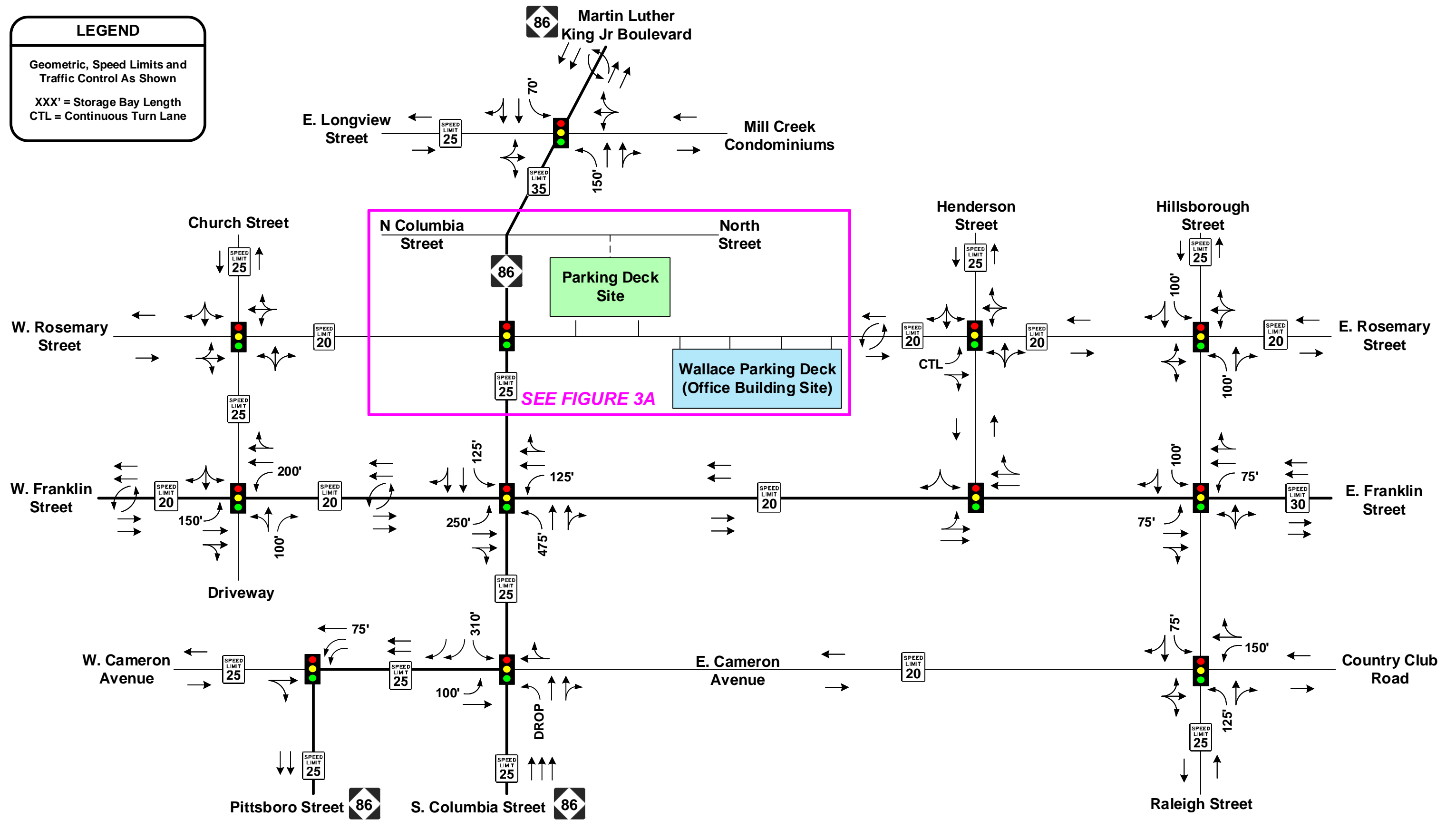

NOT TO SCALE

East Rosemary Street Parking Deck & Office Building
Transportation Impact Analysis

EXISTING LANEAGE AND GEOMETRICS





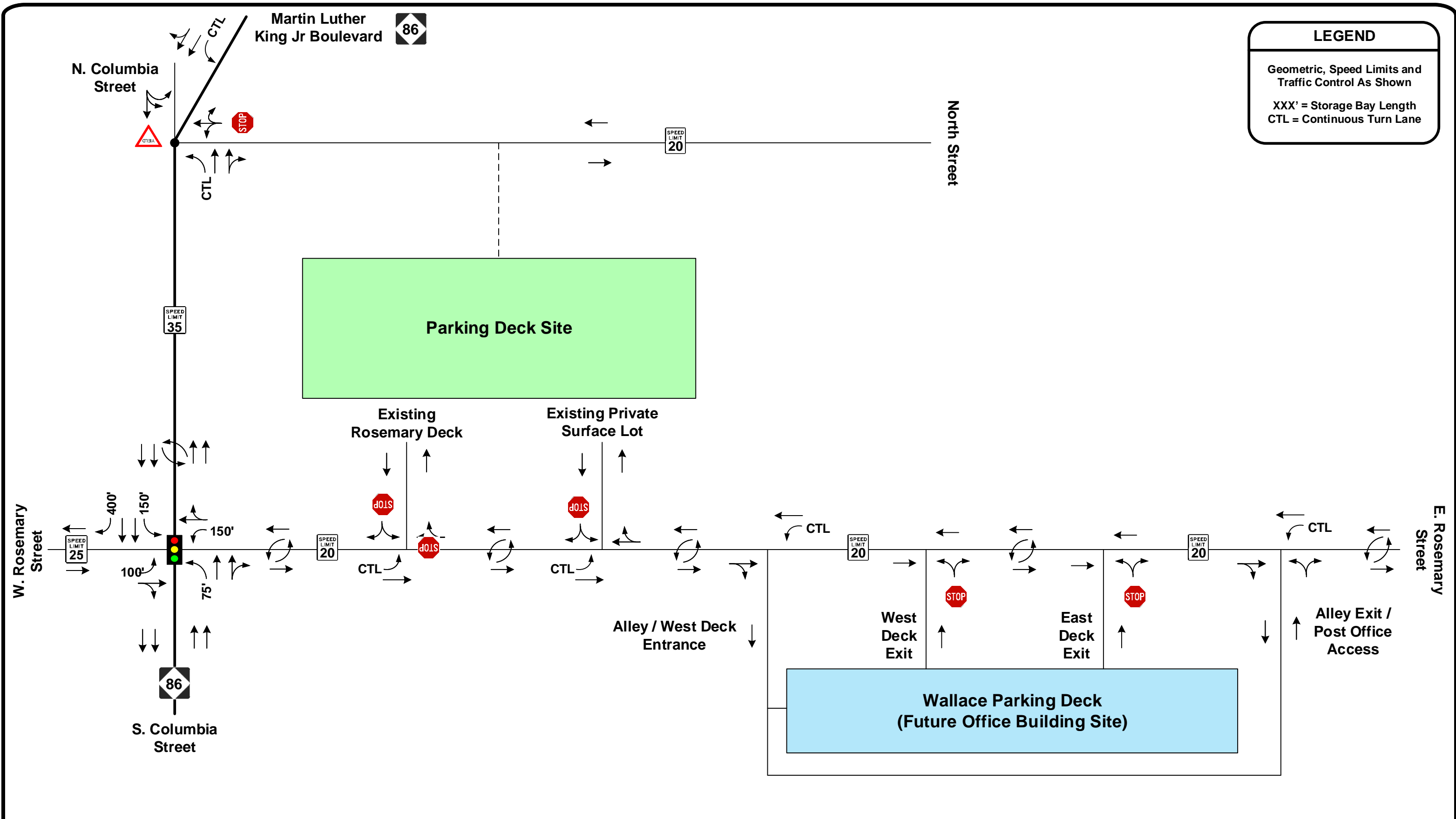

DATE: September 2020

FIGURE 3



86 Martin Luther King Jr Boulevard

LEGEND

 Bike Lanes	 Crosswalks with pedestrian signal heads
 Sidewalks	 Unsignalized Crosswalks
 Crosswalks without pedestrian signal heads	 Overstreet Walkways

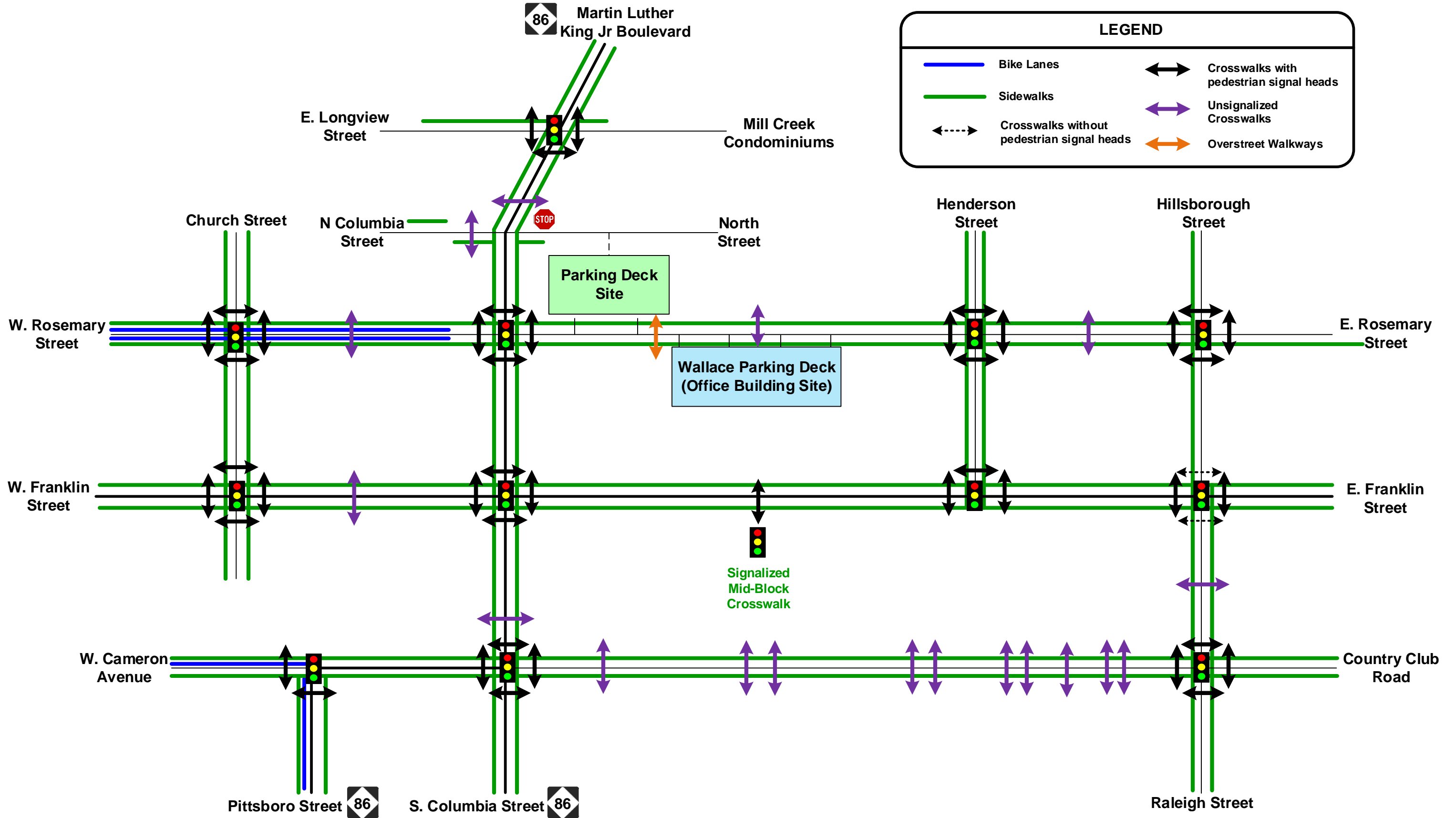

HNTB



NOT TO SCALE

East Rosemary Street Parking Deck & Office Building
Transportation Impact Analysis

DATE: September 2020

STUDY AREA PEDESTRIAN AND BICYCLE FACILITIES

FIGURE 4

LEGEND

XXX = AM Peak Hour Volume
 <XXX> = Noon Peak Hour Volume
 (XXX) = PM Peak Hour Volume

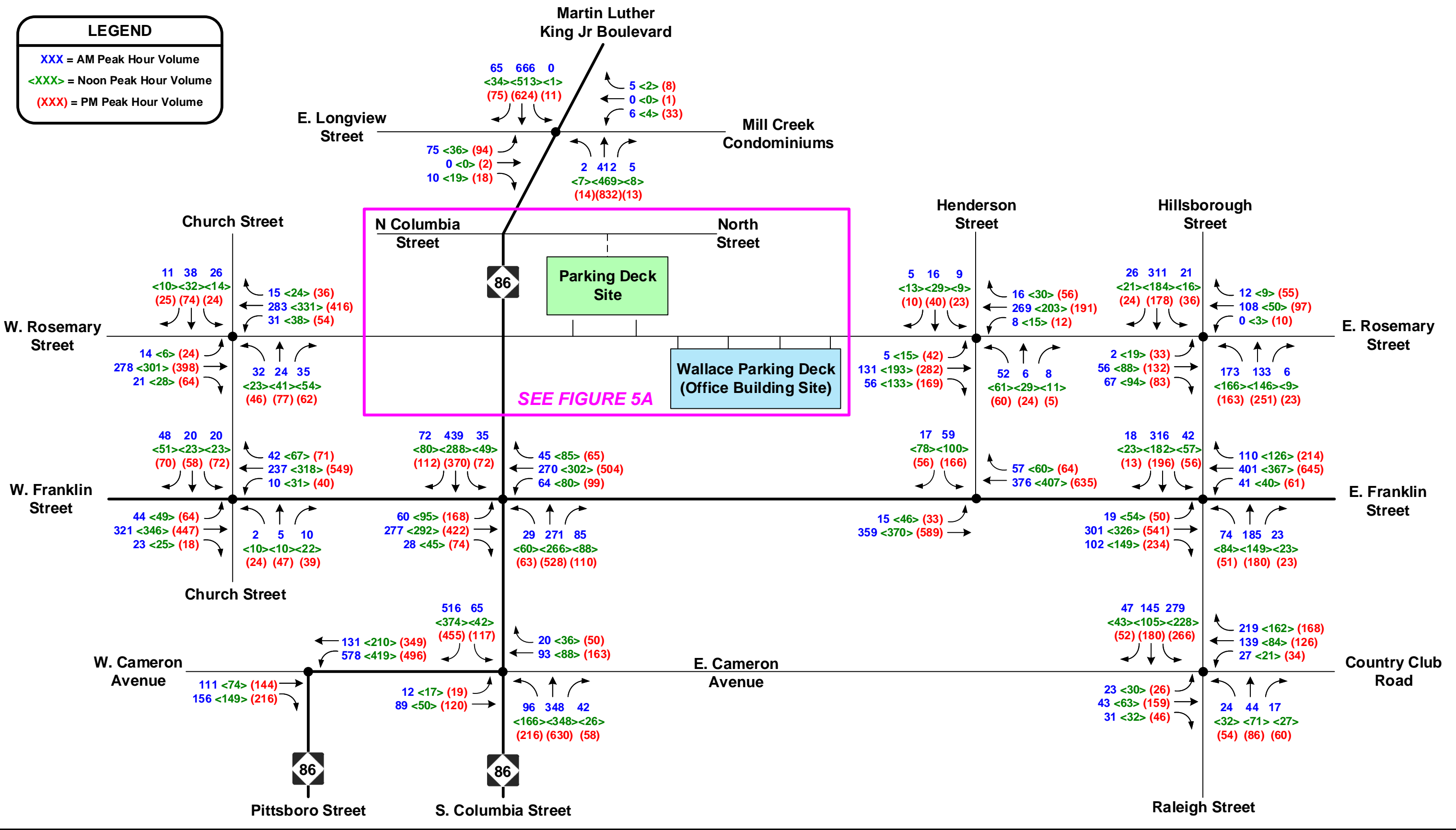

NOT TO SCALE

East Rosemary Street Parking Deck & Office Building
 Transportation Impact Analysis

2020 EXISTING PEAK HOUR TRAFFIC VOLUMES

DATE: September 2020

FIGURE 5

LEGEND

- XXX = AM Peak Hour Volume
- <XXX> = Noon Peak Hour Volume
- (XXX) = PM Peak Hour Volume

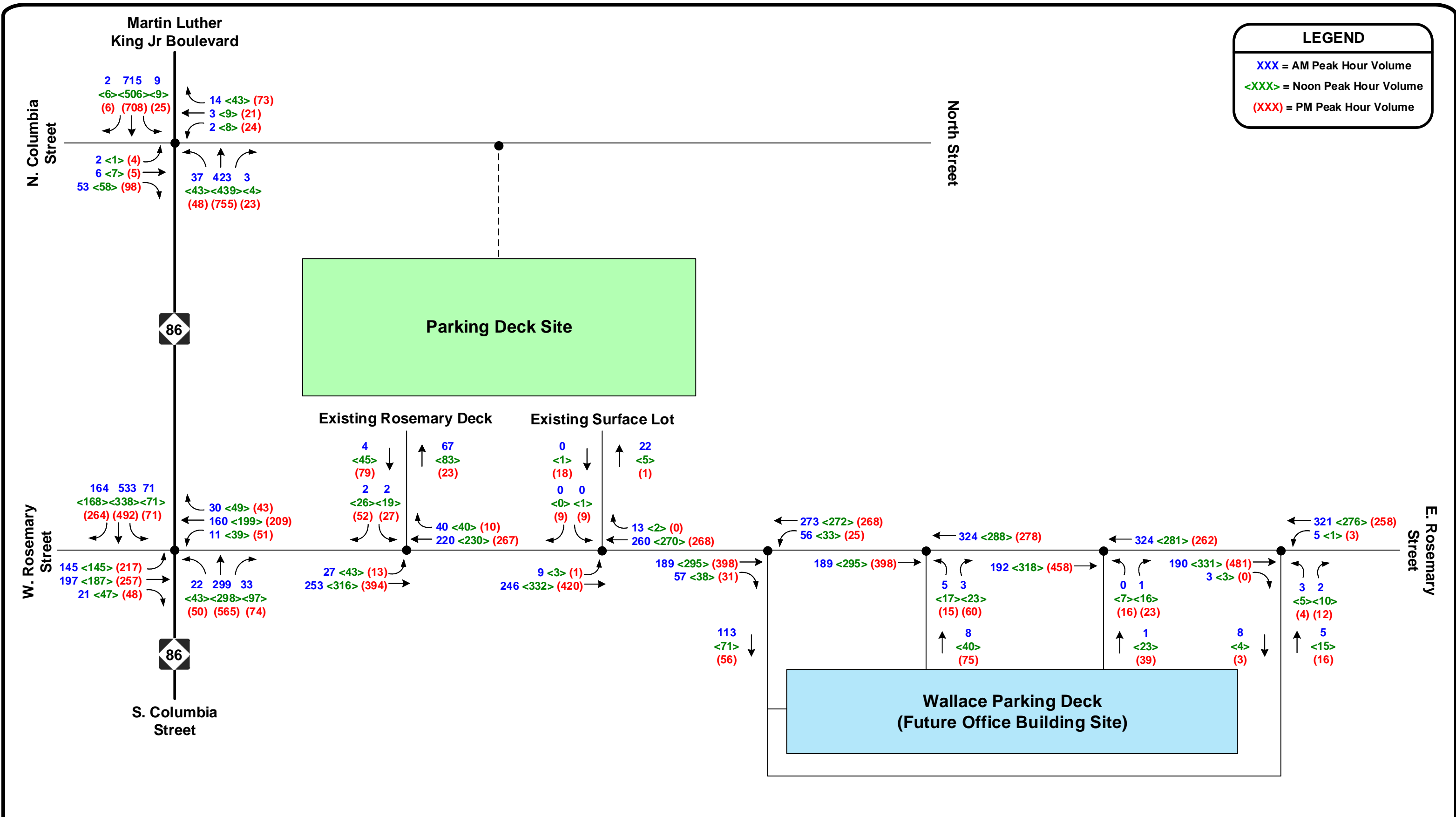

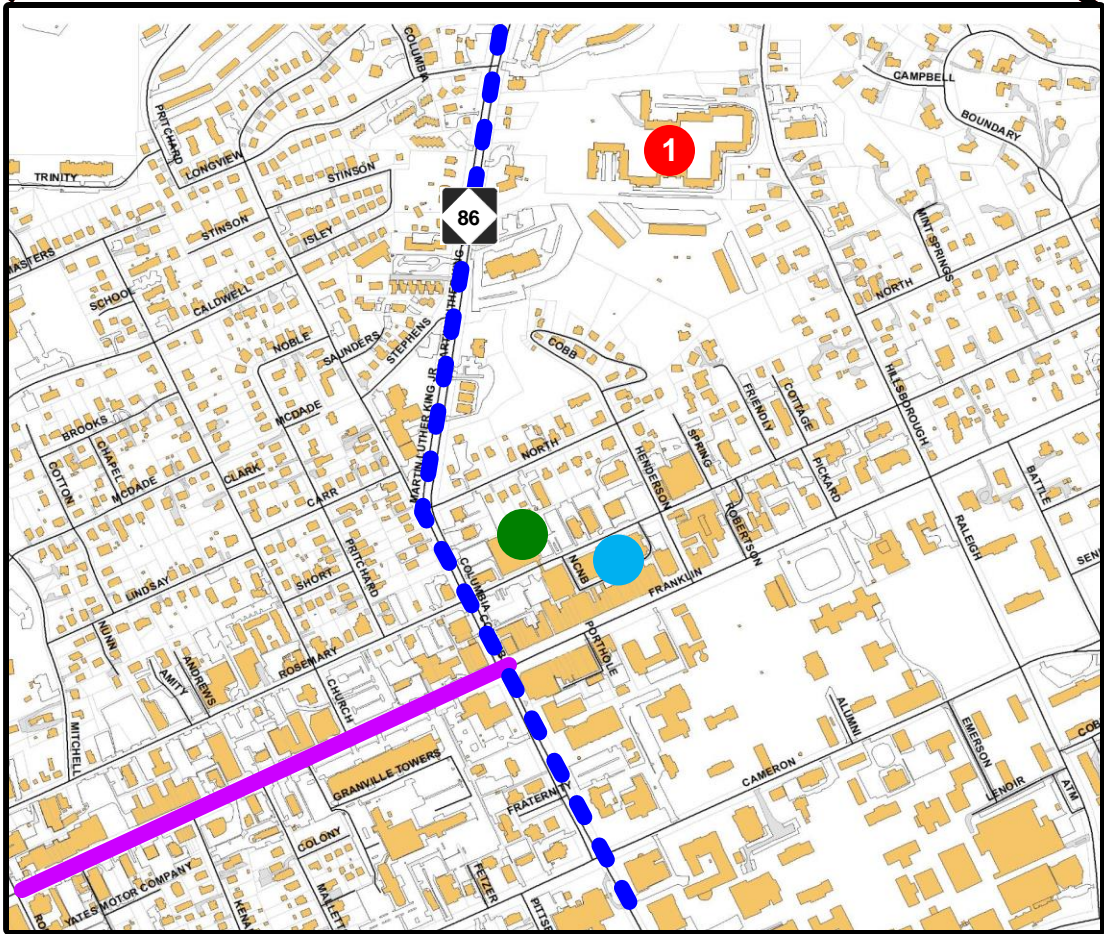
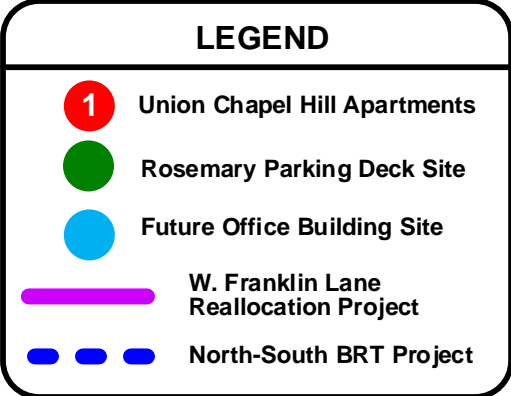
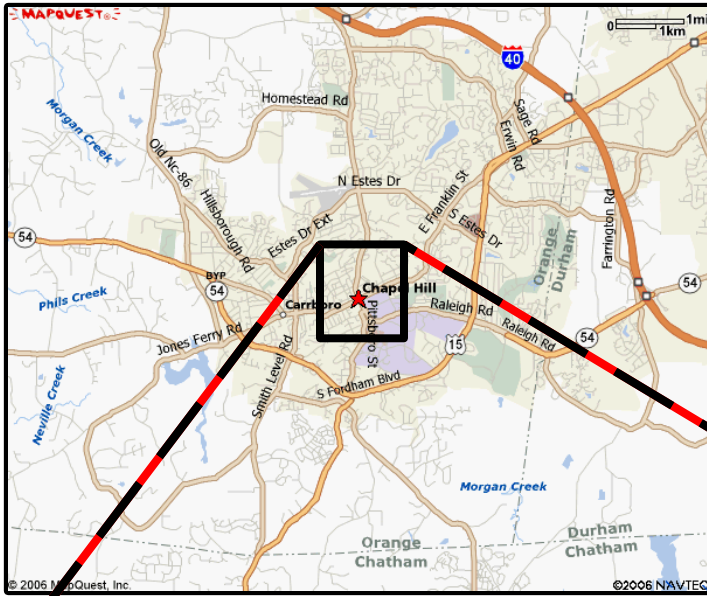

**E. Rosemary Street
 Parking Deck and Office Building
 Transportation Impact Analysis**
**BACKGROUND DEVELOPMENT AND
 TRANSPORTATION IMPROVEMENT LOCATIONS**

DATE: September 2020

FIGURE 6

LEGEND

- XXX = AM Peak Hour Volume
- <XXX> = Noon Peak Hour Volume
- (XXX) = PM Peak Hour Volume

2022 Without Site Traffic Volumes = 2020 Existing Year Traffic Volumes + 1.0%/Year Ambient Traffic Volume Growth + Specific Background Traffic Generator (Union Apartments)

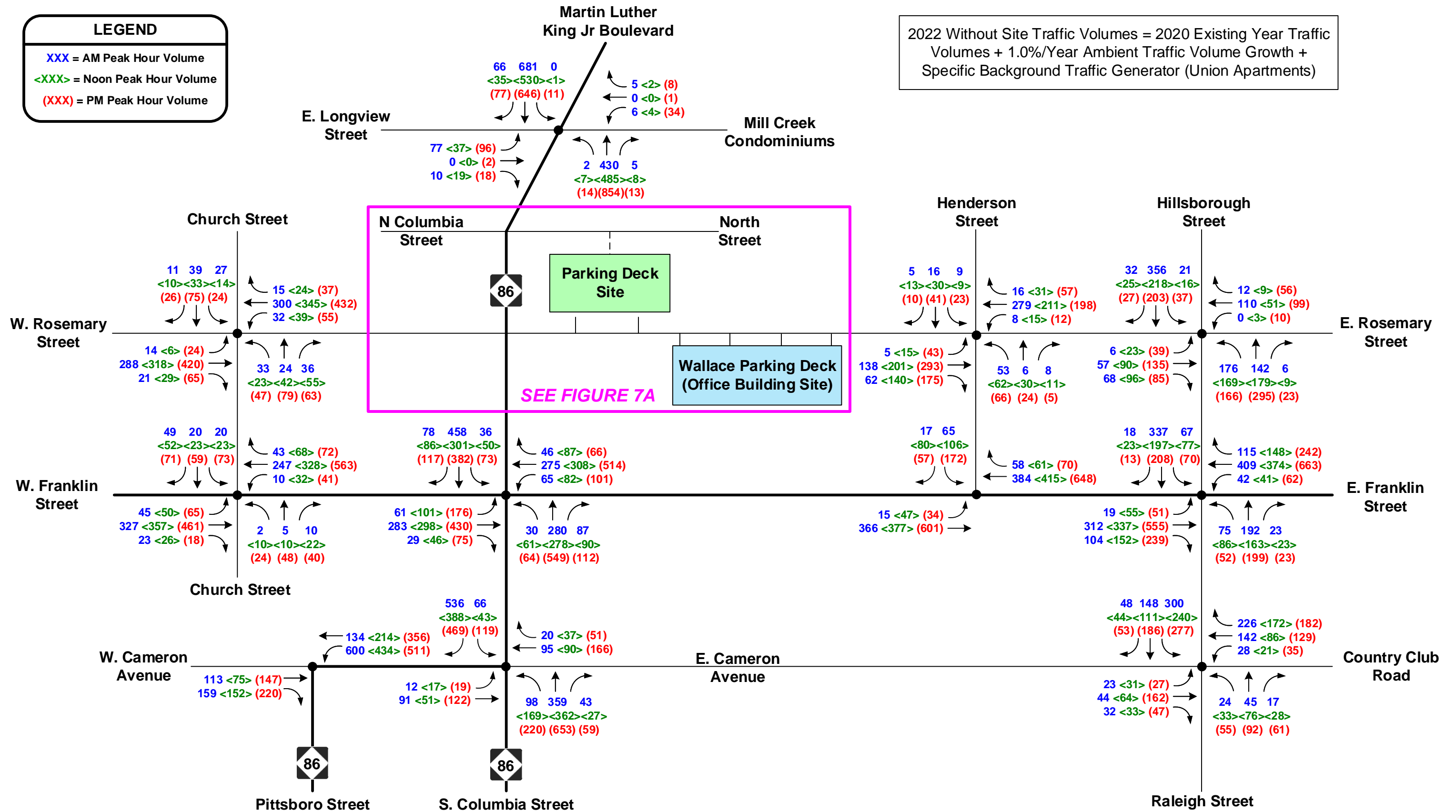

NOT TO SCALE

**East Rosemary Street Parking Deck & Office Building
Transportation Impact Analysis**

2022 PEAK HOUR TRAFFIC VOLUMES WITHOUT SITE

DATE: September 2020

FIGURE 7

LEGEND

- XXX = AM Peak Hour Volume
- <XXX> = Noon Peak Hour Volume
- (XXX) = PM Peak Hour Volume

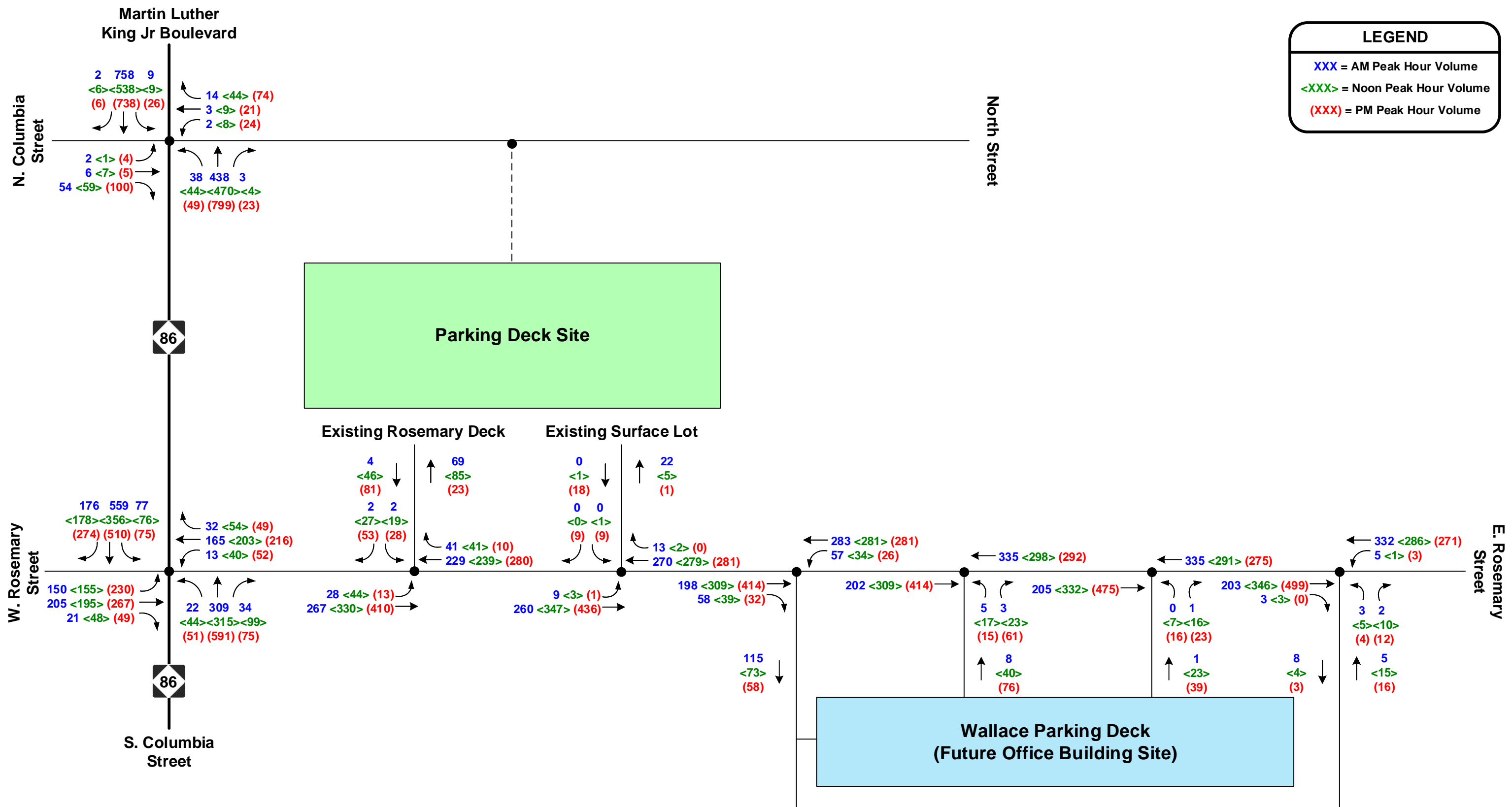

DRAFT

LEGEND

XX% = Site Trip Distribution Percentage Entering

XX% = Site Trip Distribution Percentage Exiting

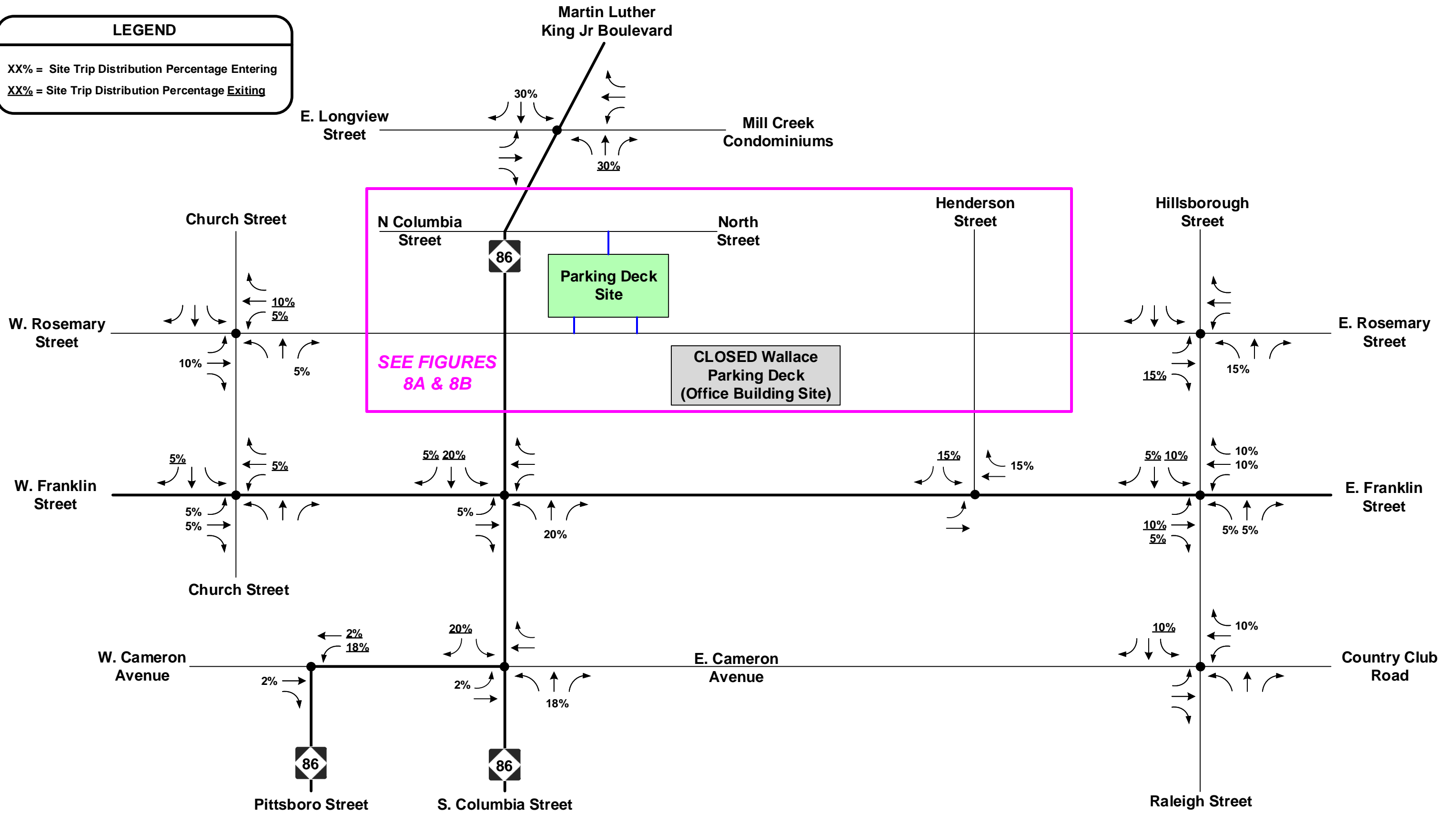

NOT TO SCALE

East Rosemary Street Parking Deck & Office Building
Transportation Impact Analysis

DATE: September 2020

2022 PARKING DECK SITE TRIP DISTRIBUTION PERCENTAGES – ALL ACCESS SCENARIOS

FIGURE 8

LEGEND

XX% = Site Trip Distribution Percentage Entering

XX% = Site Trip Distribution Percentage Exiting

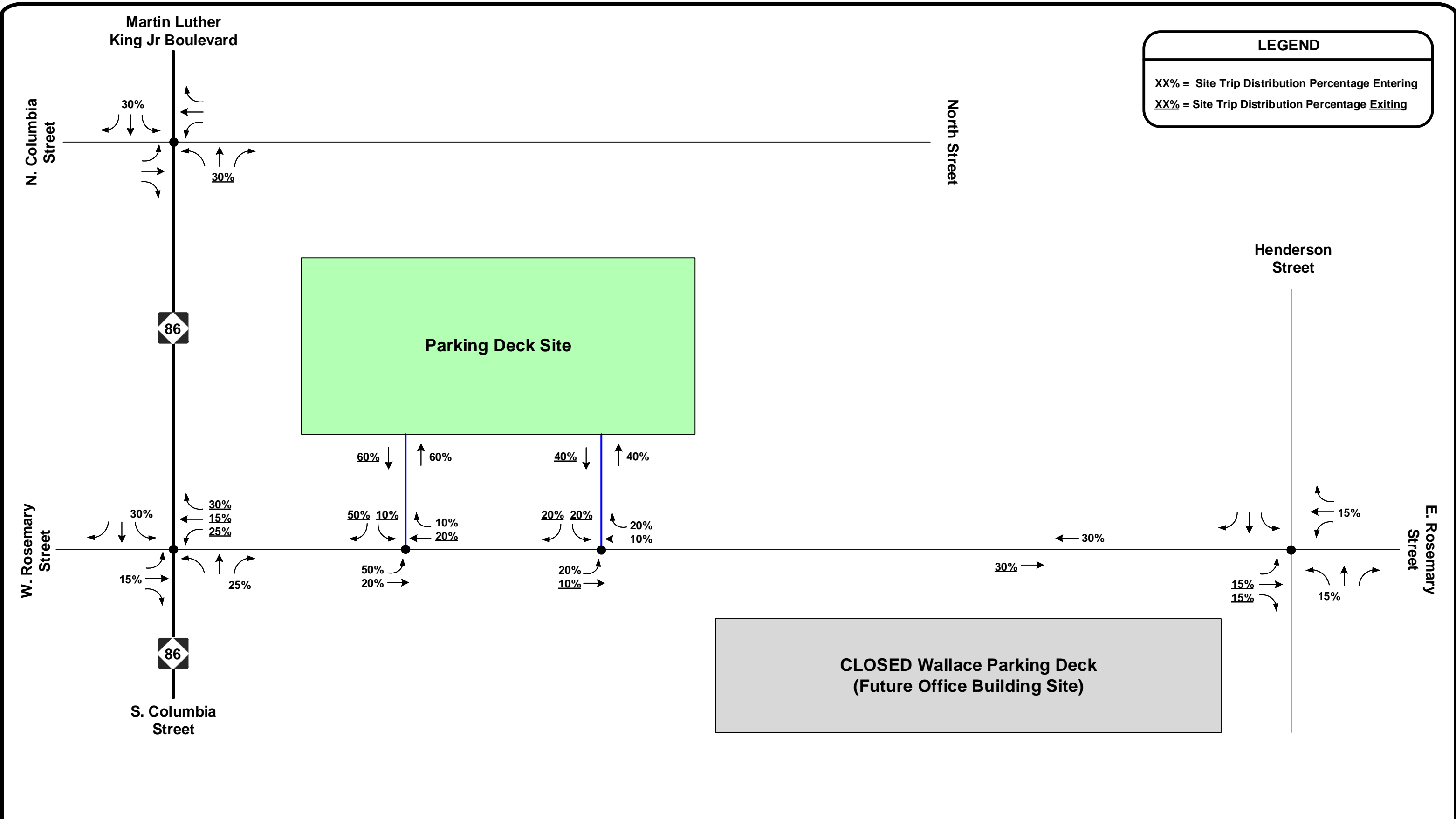

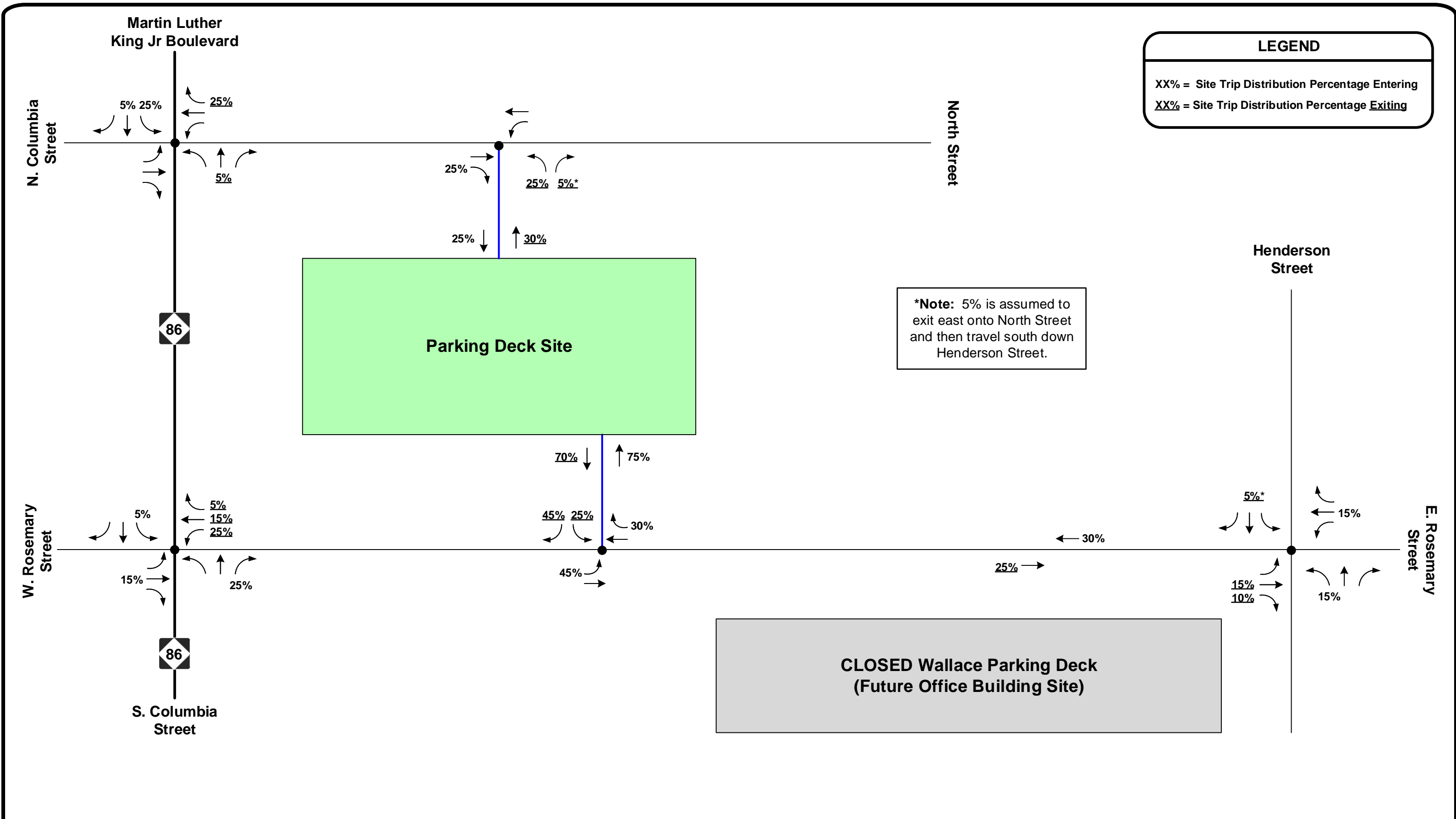

LEGEND

XX% = Site Trip Distribution Percentage Entering

XX% = Site Trip Distribution Percentage Exiting

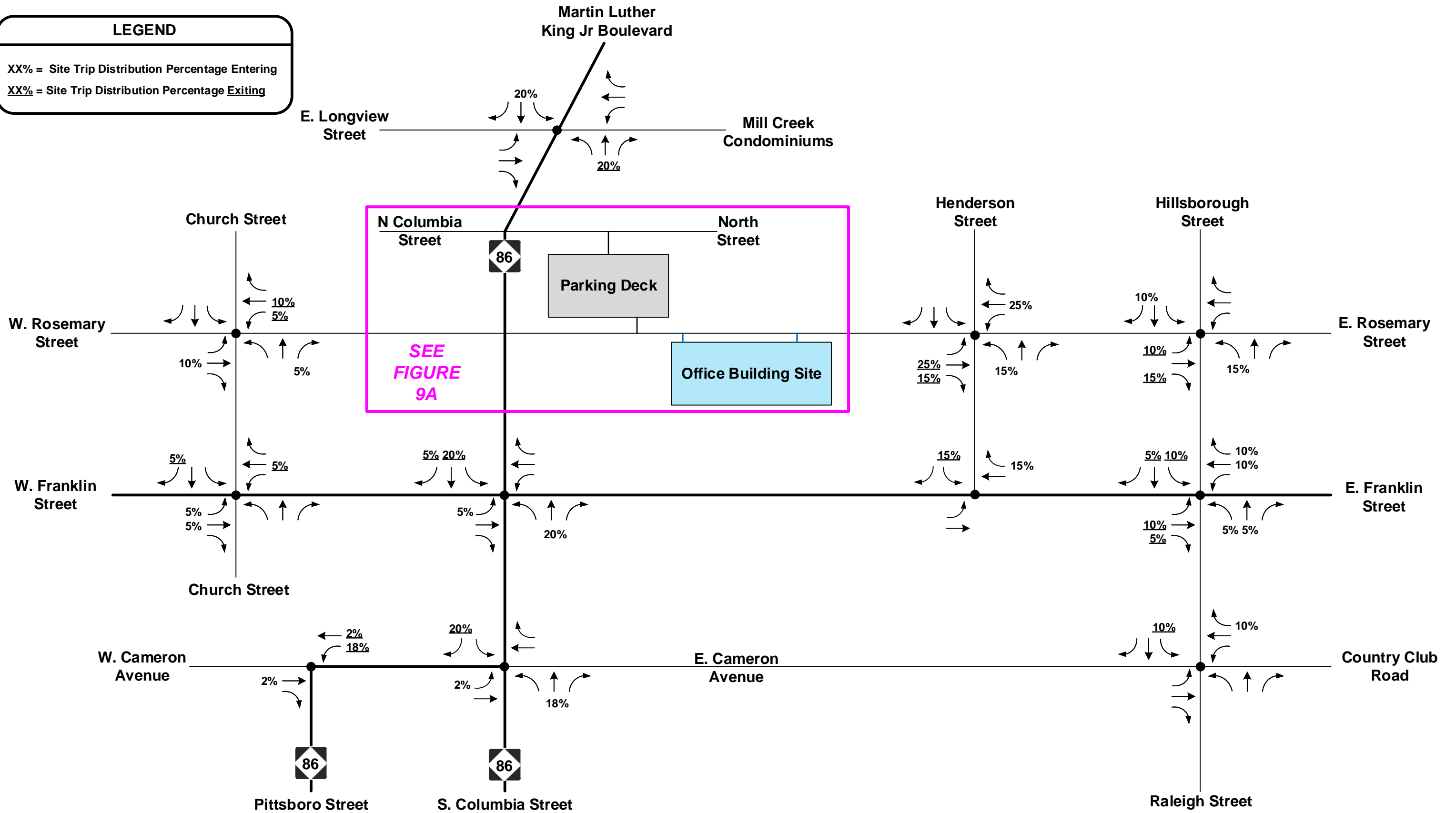

NOT TO SCALE

East Rosemary Street Parking Deck & Office Building
 Transportation Impact Analysis

DATE: September 2020

2023 SITE TRIP DISTRIBUTION PERCENTAGES – OFFICE BUILDING PARKING

FIGURE 9

LEGEND

XX% = Site Trip Distribution Percentage Entering

XX% = Site Trip Distribution Percentage Exiting

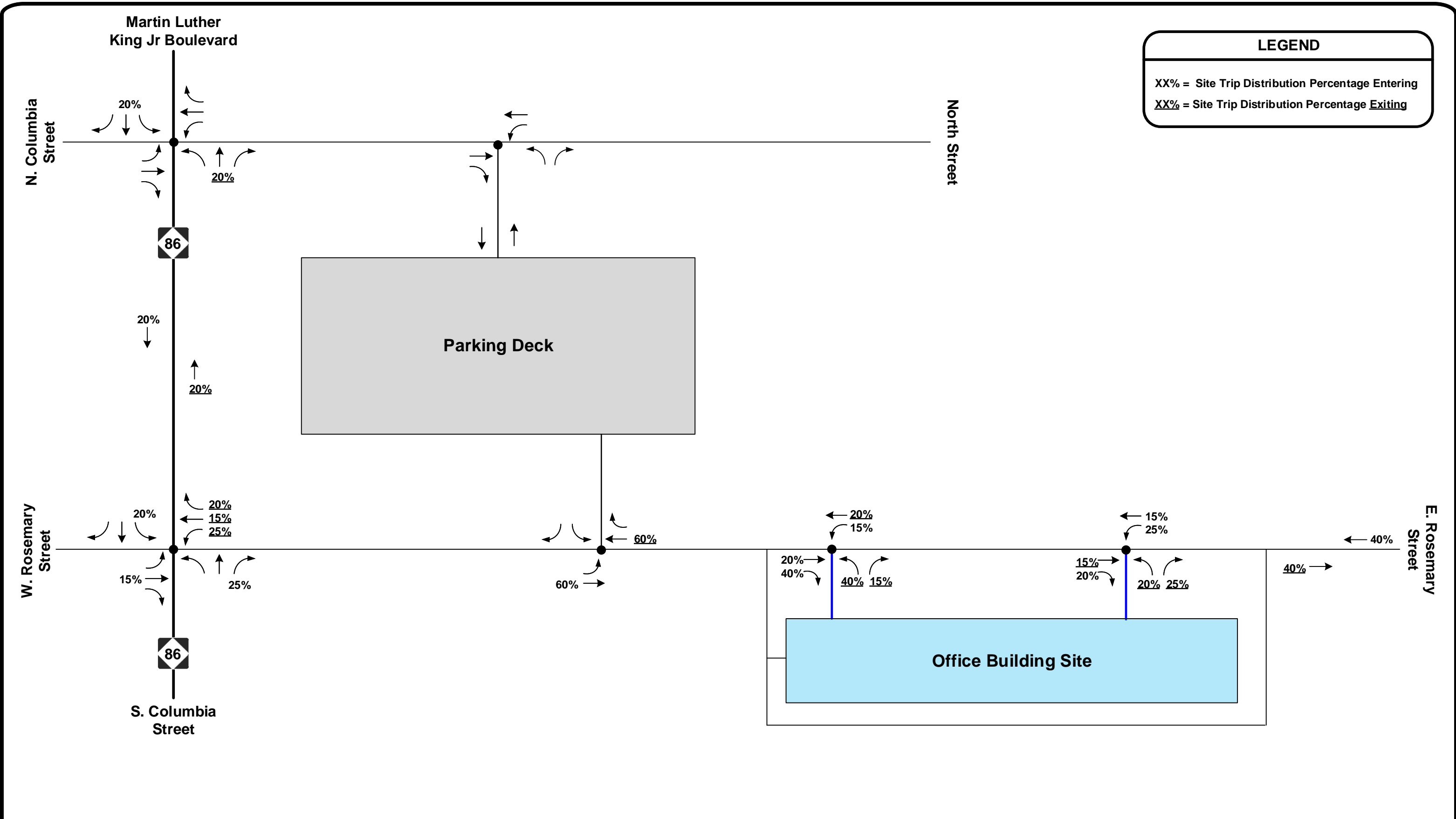

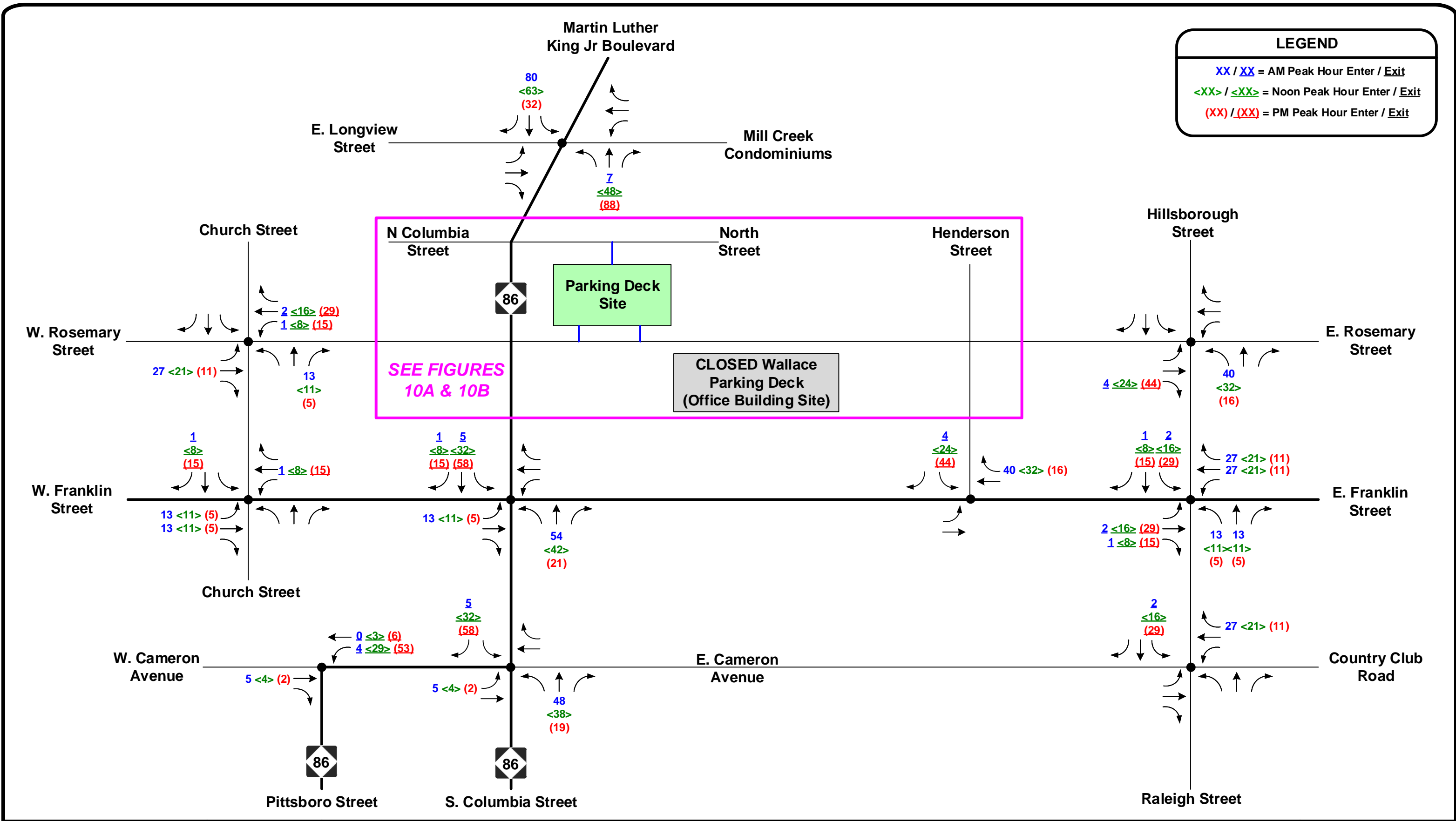

LEGEND

XX / XX = AM Peak Hour Enter / Exit

<XX> / <XX> = Noon Peak Hour Enter / Exit

(XX) / (XX) = PM Peak Hour Enter / Exit

SEE FIGURES 10A & 10B

CLOSED Wallace Parking Deck (Office Building Site)

LEGEND

XX / XX = AM Peak Hour Enter / Exit

<XX> / <XX> = Noon Peak Hour Enter / Exit

(XX) / (XX) = PM Peak Hour Enter / Exit

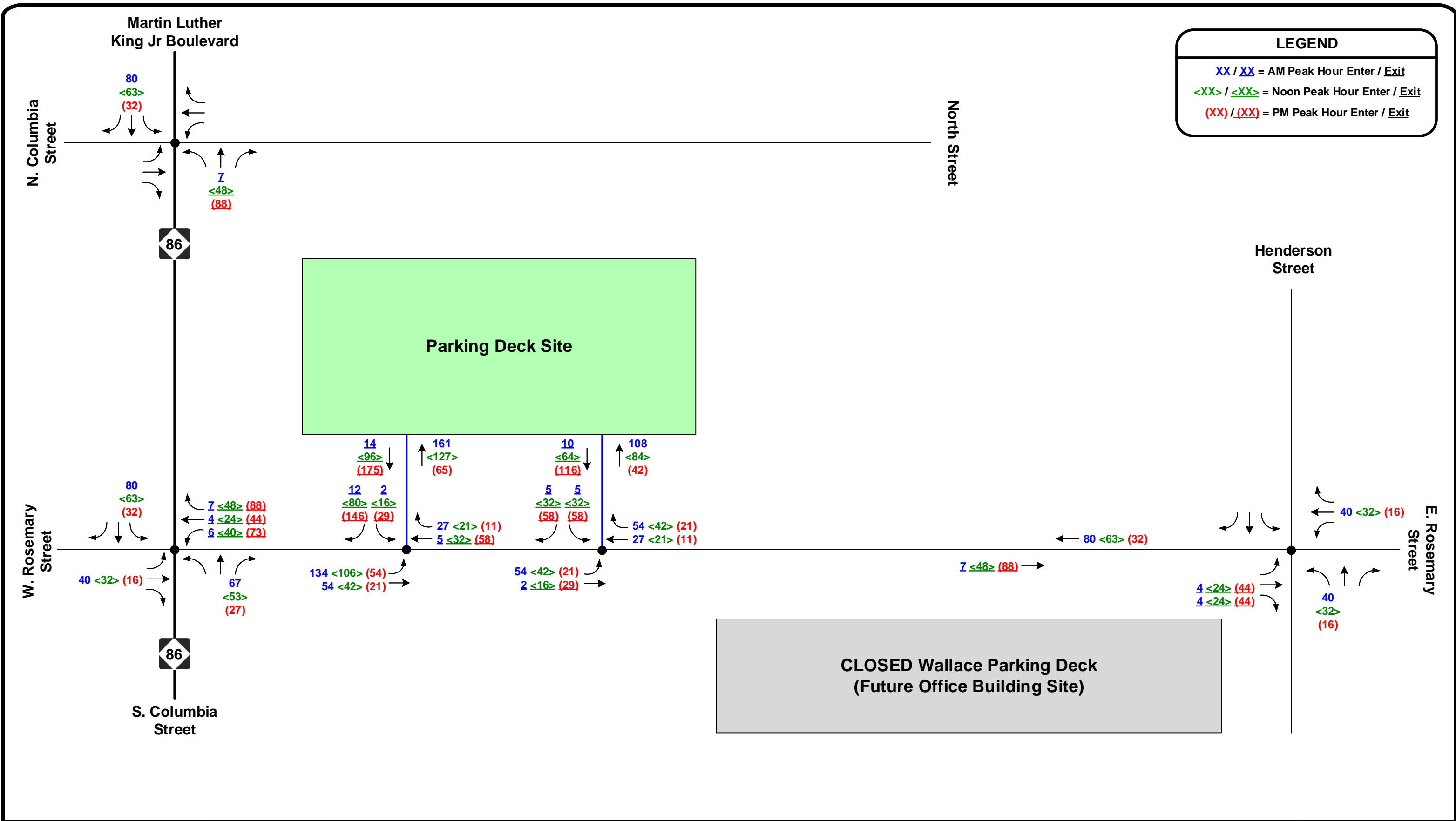

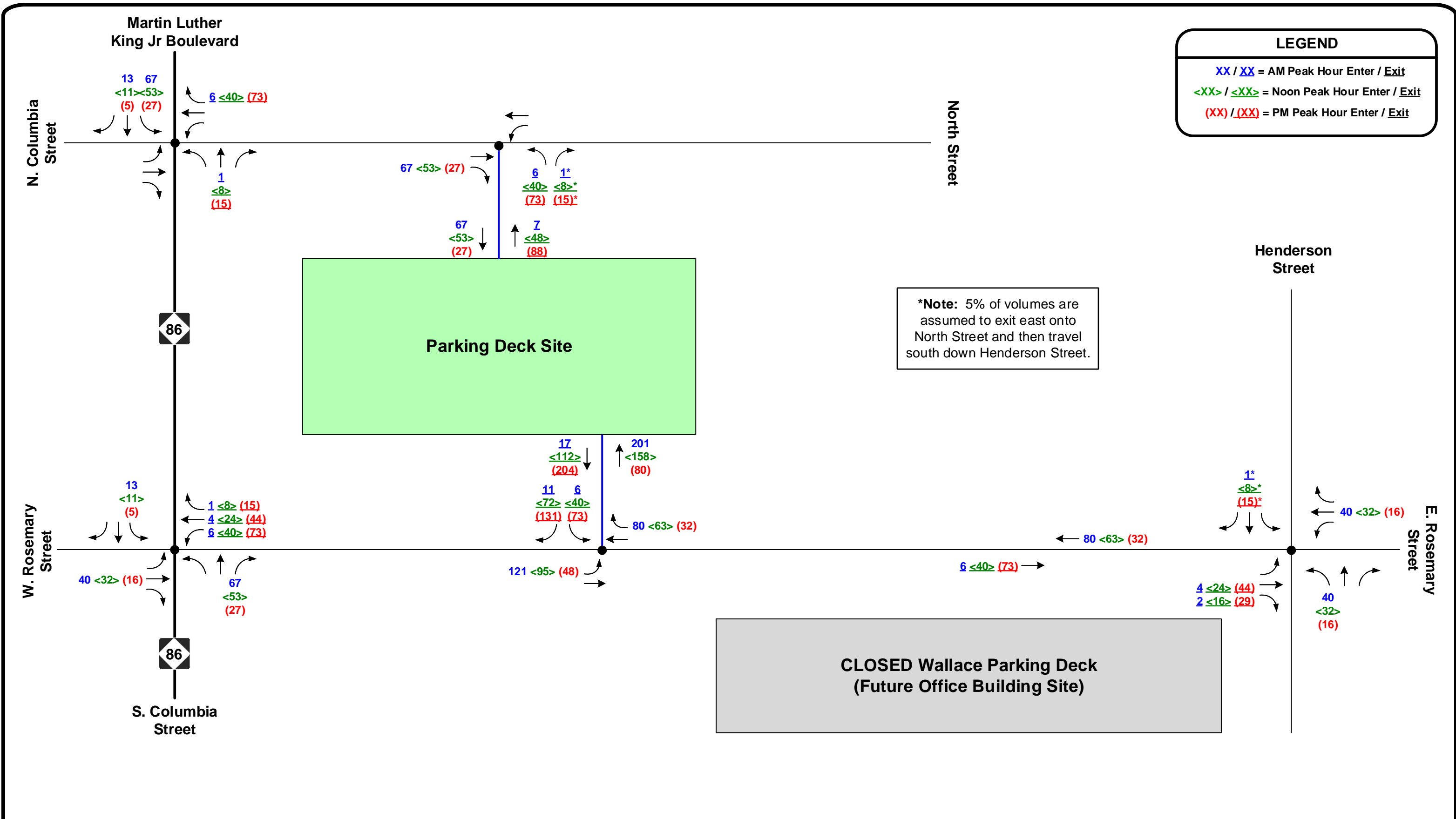

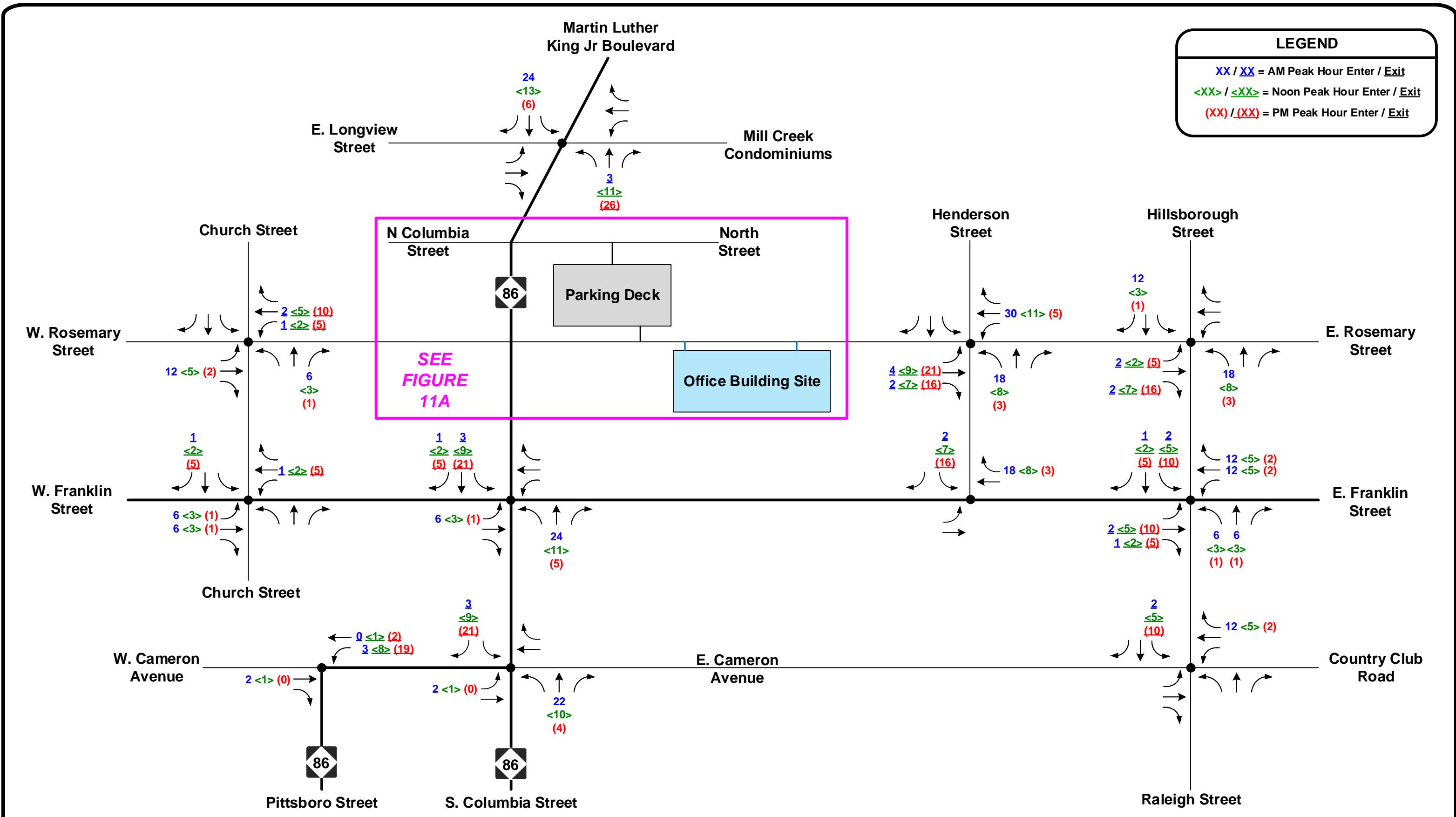

LEGEND

XX / XX = AM Peak Hour Enter / Exit

<XX> / <XX> = Noon Peak Hour Enter / Exit

(XX) / (XX) = PM Peak Hour Enter / Exit

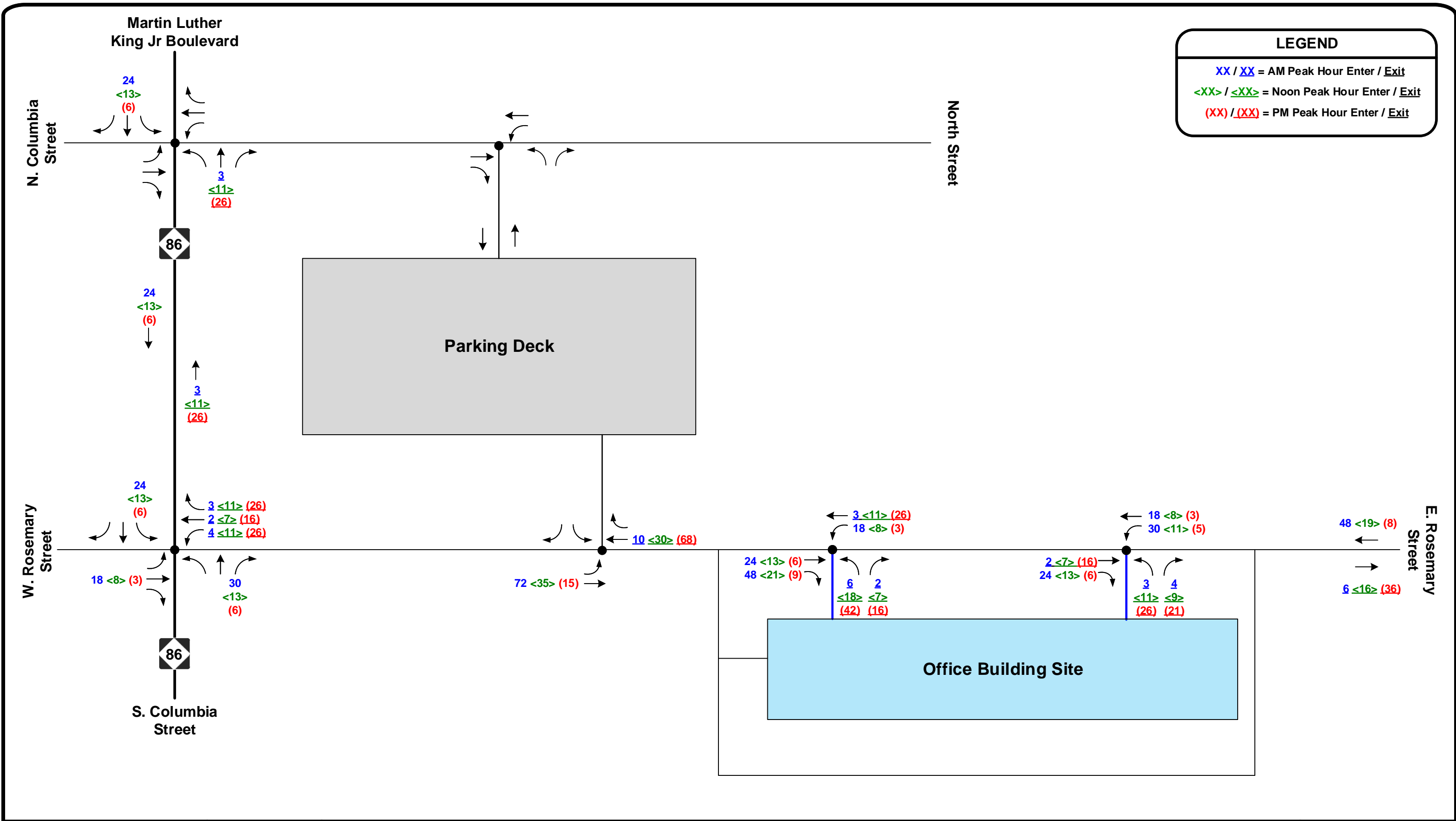

LEGEND

- XXX = AM Peak Hour Volume
- <XXX> = Noon Peak Hour Volume
- (XXX) = PM Peak Hour Volume

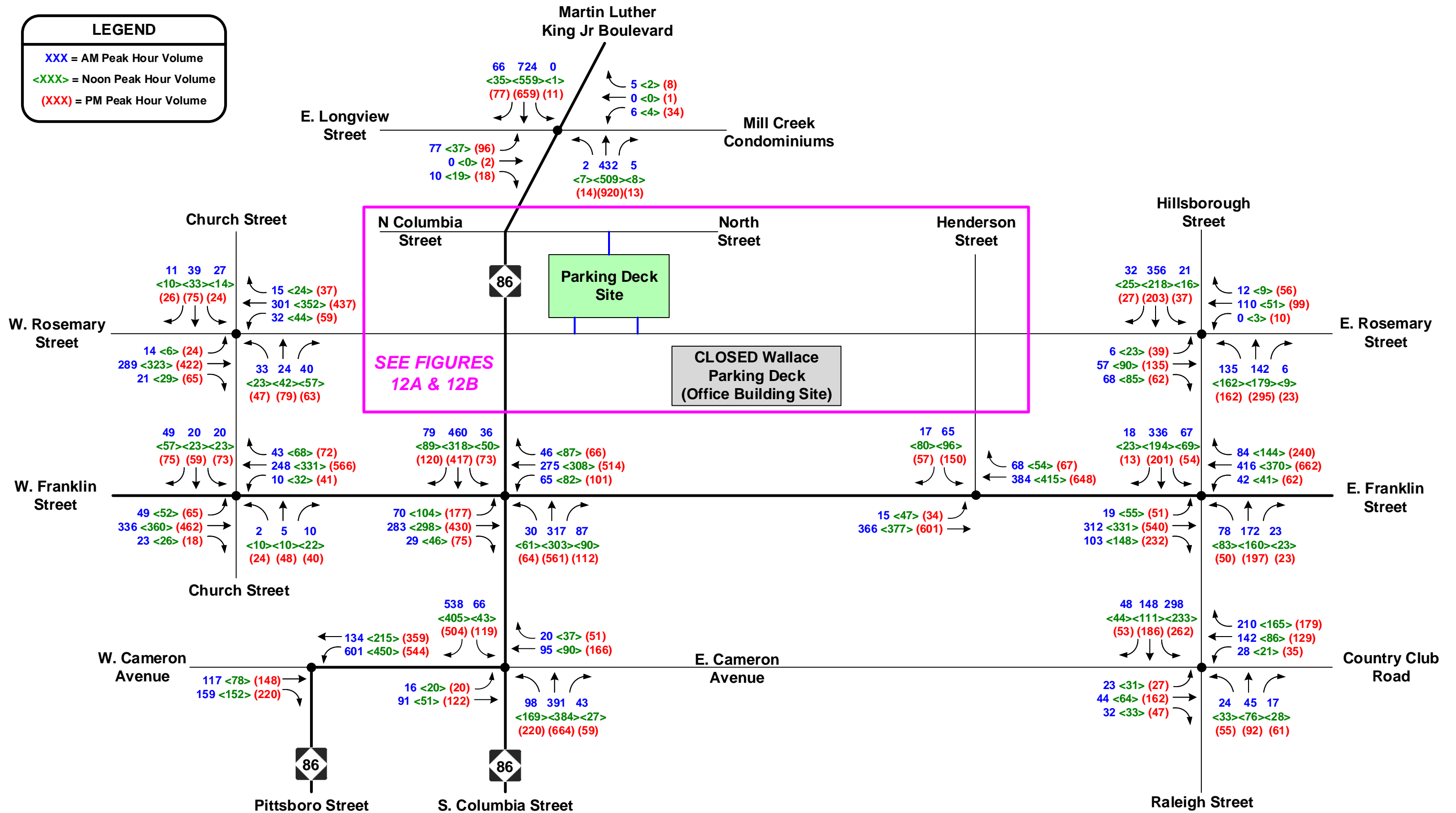

NOT TO SCALE

**East Rosemary Street Parking Deck & Office Building
Transportation Impact Analysis**

DATE: September 2020

2022 PEAK HOUR TRAFFIC VOLUMES WITH PARKING DECK – ALL ACCESS SCENARIOS

FIGURE 12

LEGEND

- XXX = AM Peak Hour Volume
- <XXX> = Noon Peak Hour Volume
- (XXX) = PM Peak Hour Volume

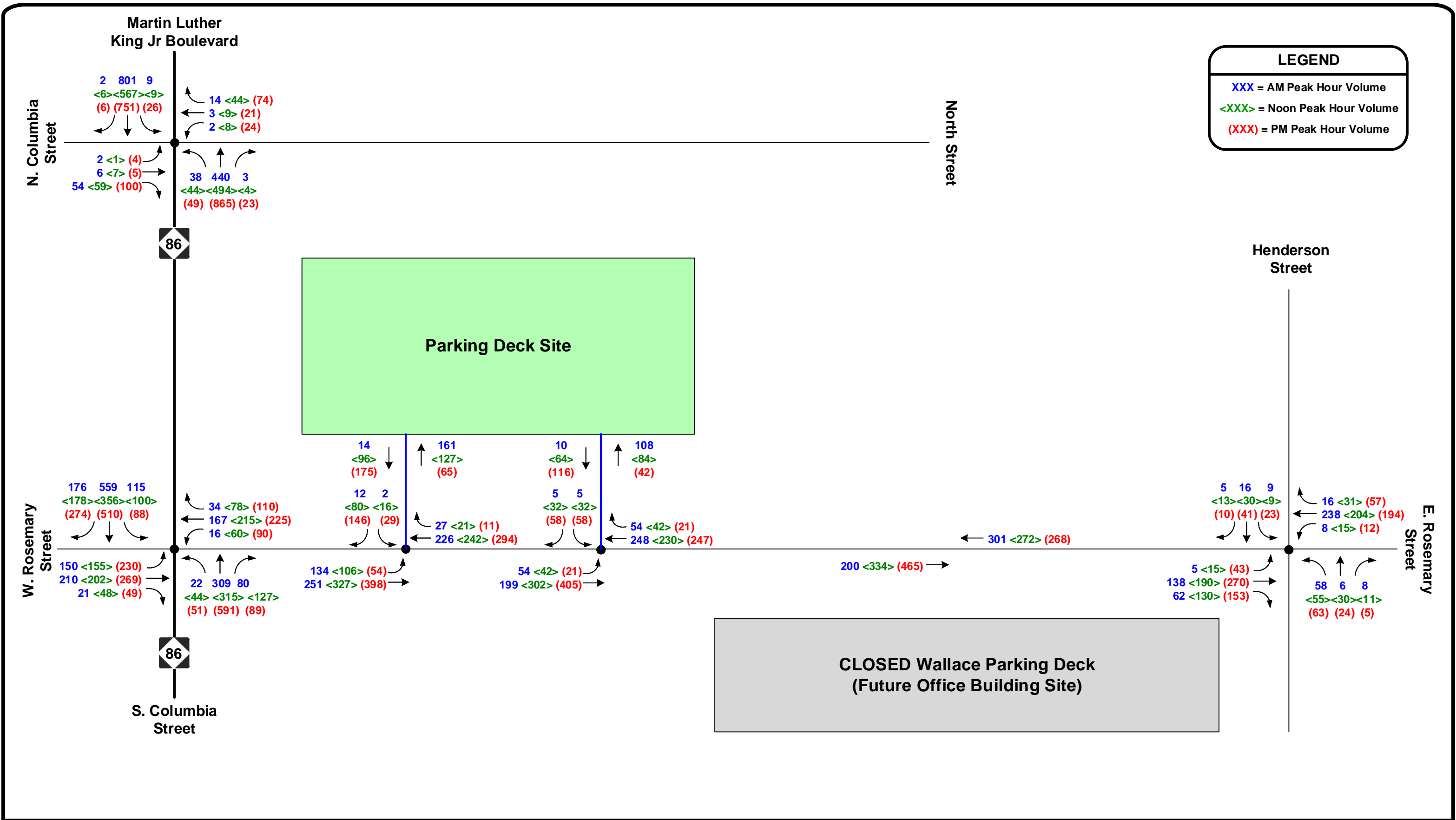

LEGEND

XXX = AM Peak Hour Volume
 <XXX> = Noon Peak Hour Volume
 (XXX) = PM Peak Hour Volume

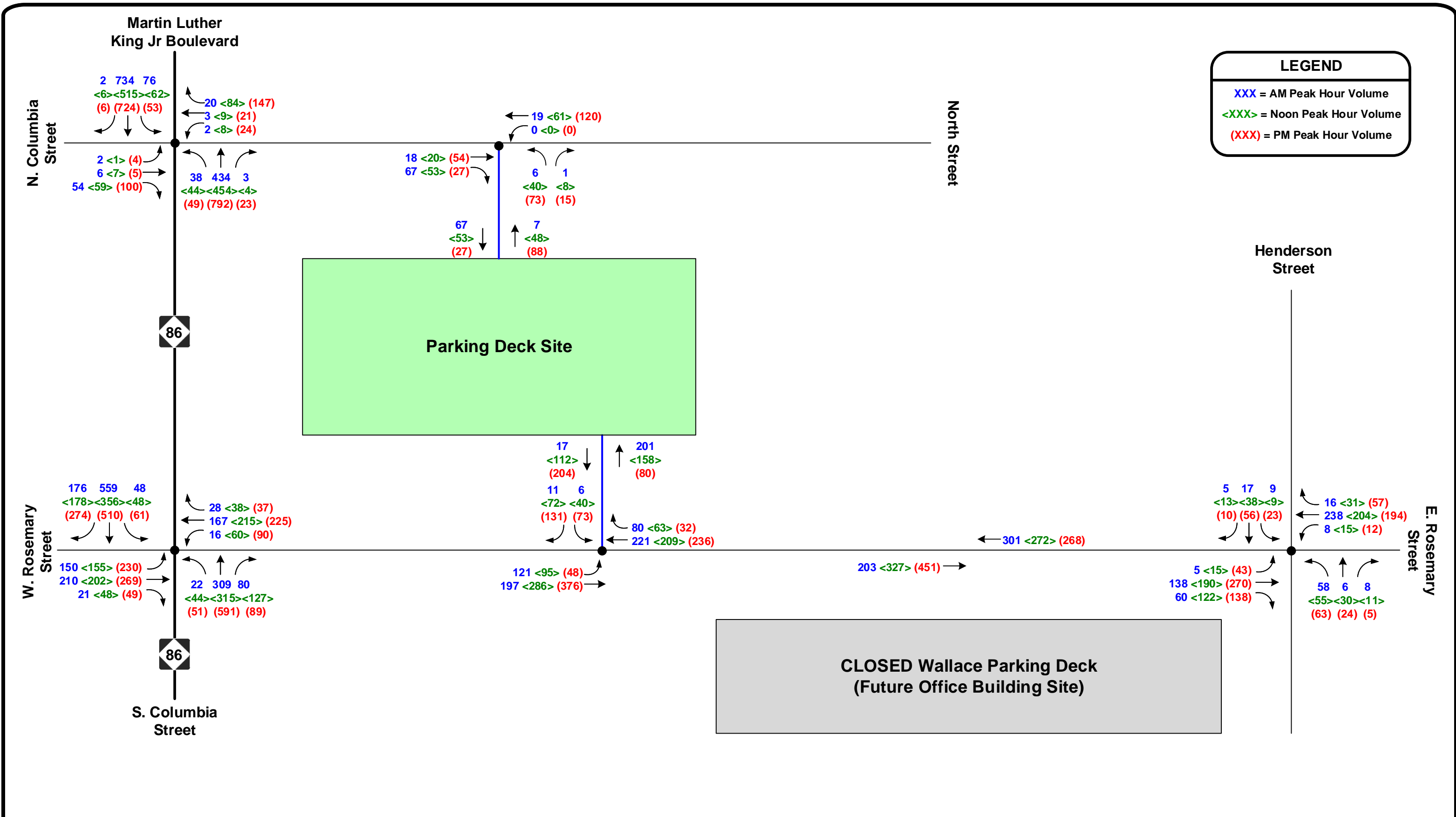
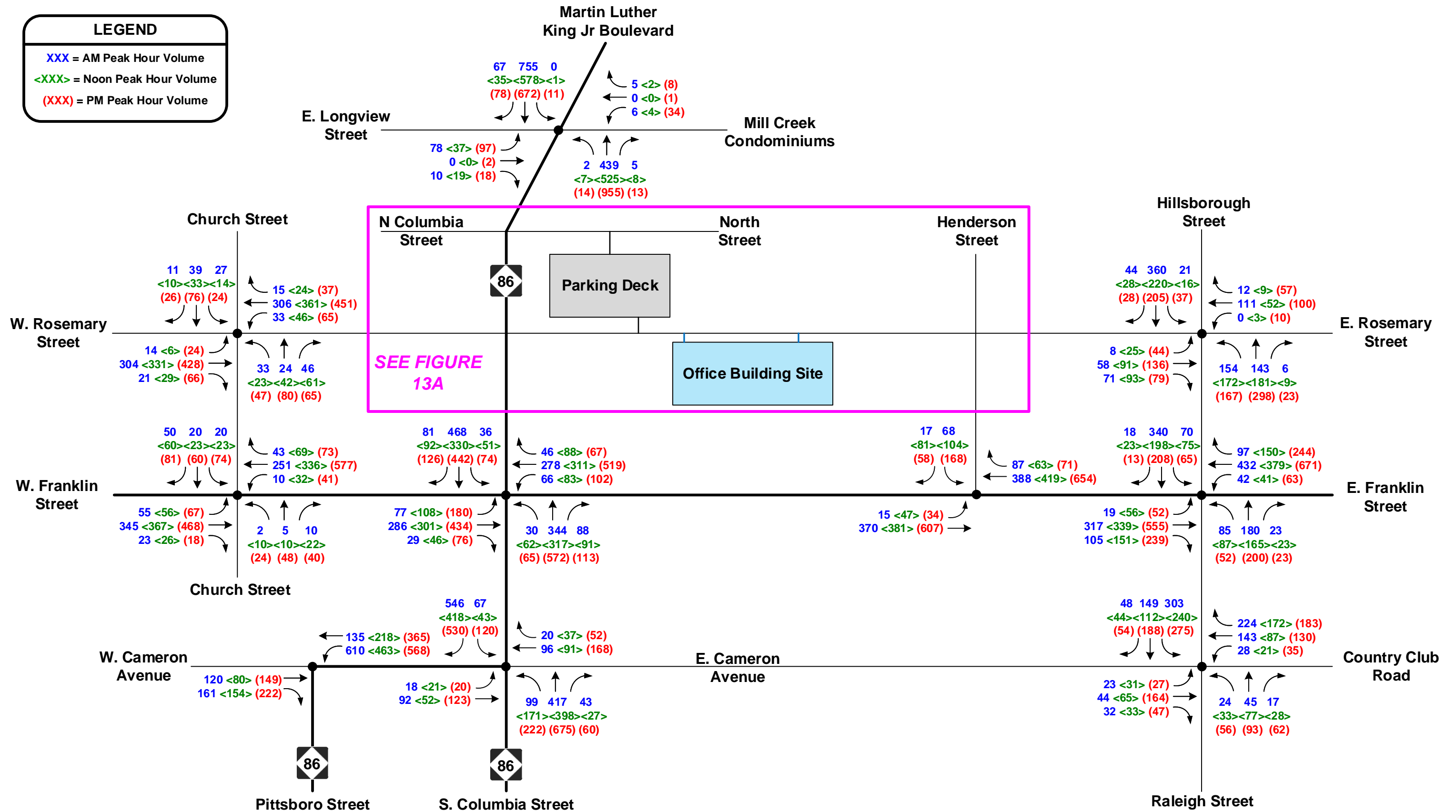

FIGURE 12B

LEGEND

- XXX = AM Peak Hour Volume
- <XXX> = Noon Peak Hour Volume
- (XXX) = PM Peak Hour Volume



SEE FIGURE 13A

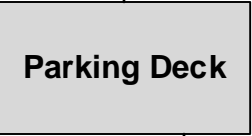

NOT TO SCALE

**East Rosemary Street Parking Deck & Office Building
Transportation Impact Analysis**

DATE: September 2020

2023 PEAK HOUR TRAFFIC VOLUMES – WITH OFFICE BUILDING

FIGURE 13

LEGEND

XXX = AM Peak Hour Volume
 <XXX> = Noon Peak Hour Volume
 (XXX) = PM Peak Hour Volume

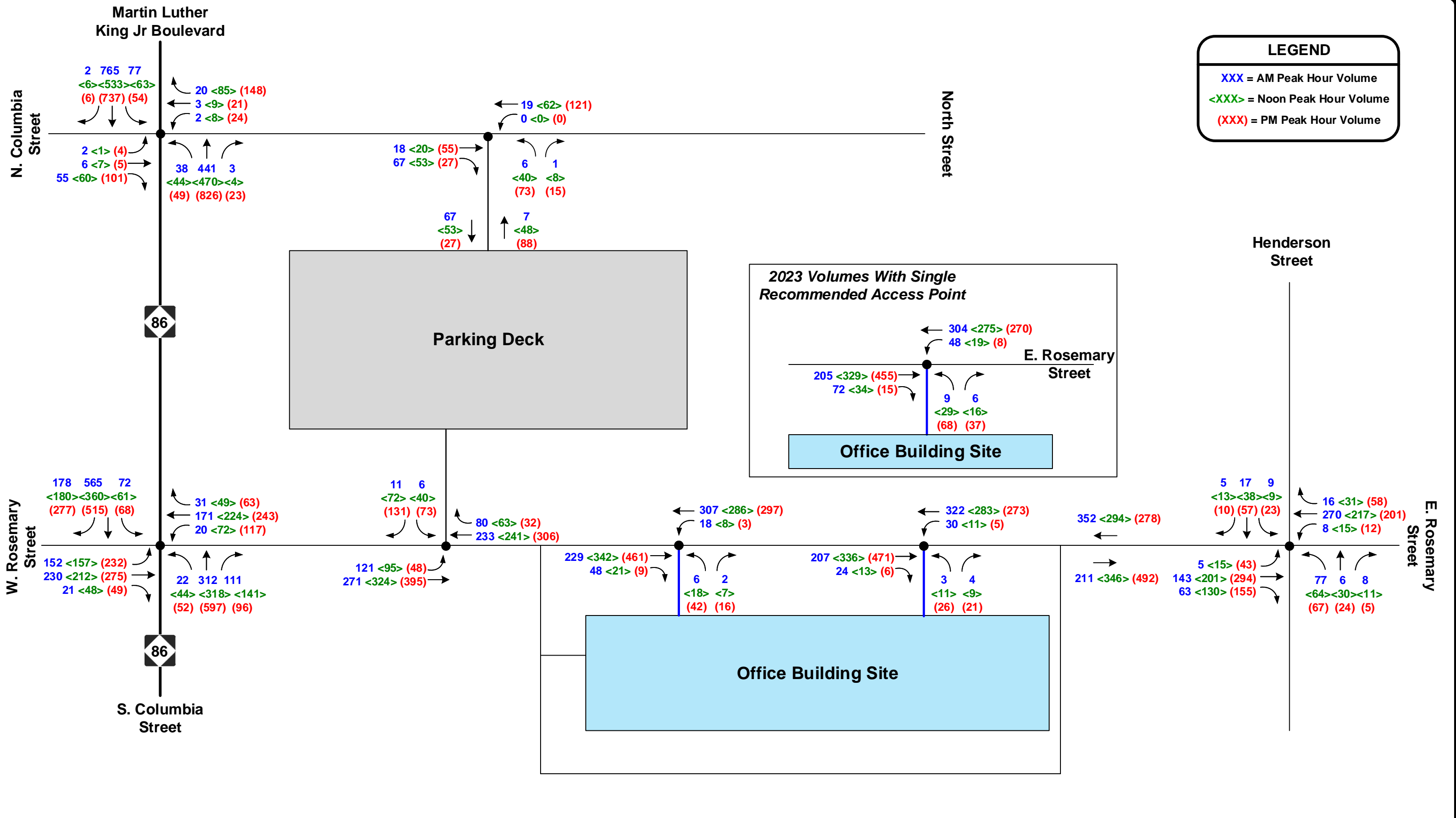

LEGEND

- = PLANNED/COMMITTED SIGNAL TIMING & GEOMETRIC IMPROVEMENT
- = NECESSARY IMPROVEMENT
- BLACK BOX = 2022 NO-BUILD
- PURPLE BOX = 2022 BUILD
- GREEN BOX = 2022 BUILD & MITIGATION
- AM <NOON> (PM) PEAK HOUR LOS

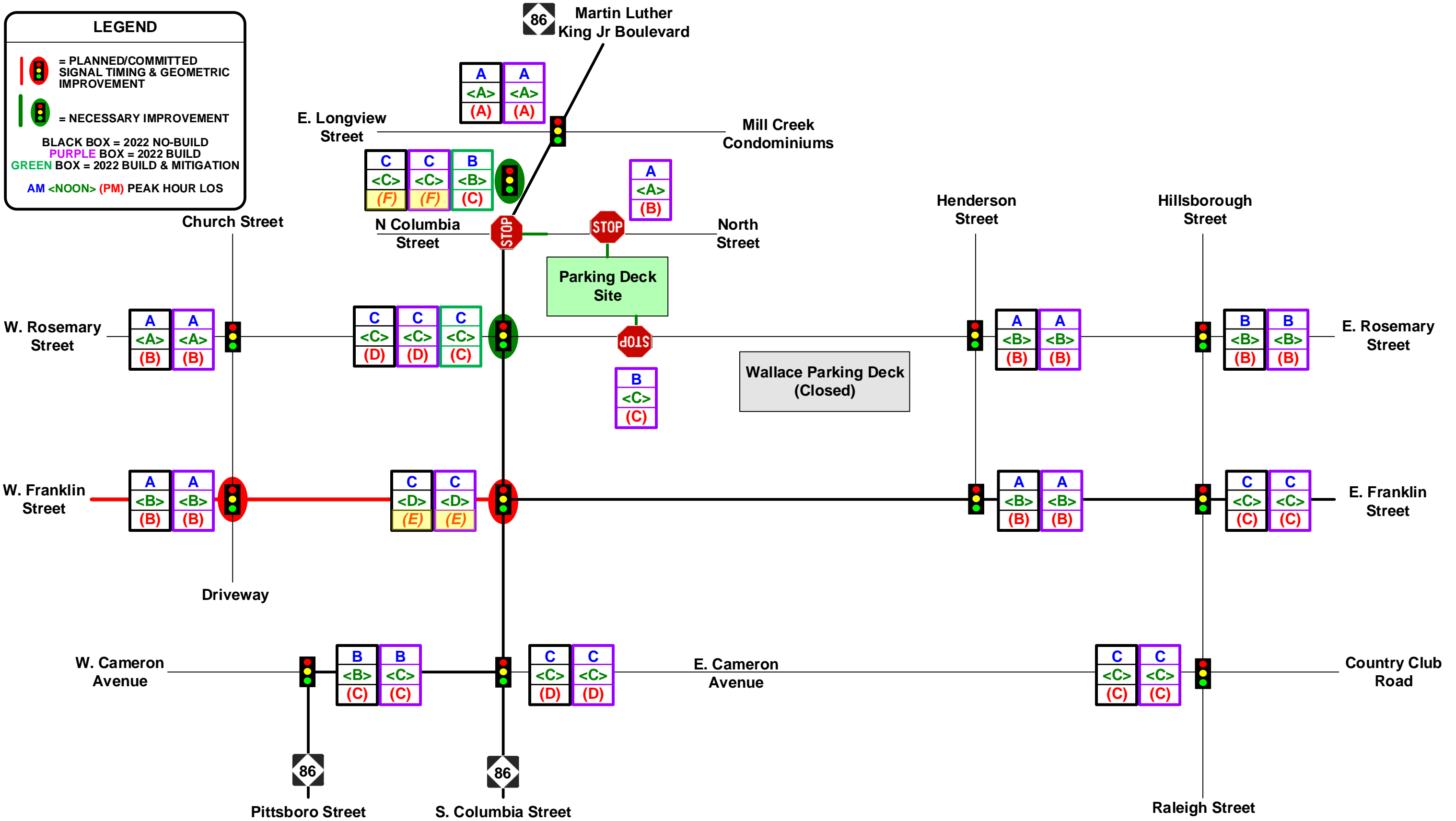

NOT TO SCALE

East Rosemary Street Parking Deck & Office Building
 Transportation Impact Analysis

2022 LEVEL OF SERVICE SUMMARY

DATE: September 2020

FIGURE 14

LEGEND

- = PLANNED/COMMITTED SIGNAL TIMING & GEOMETRIC IMPROVEMENT
- = NECESSARY IMPROVEMENT
- BLACK BOX = 2023 NO-BUILD
- PURPLE BOX = 2023 BUILD
- GREEN BOX = 2023 BUILD & MITIGATION
- AM <NOON> (PM) PEAK HOUR LOS

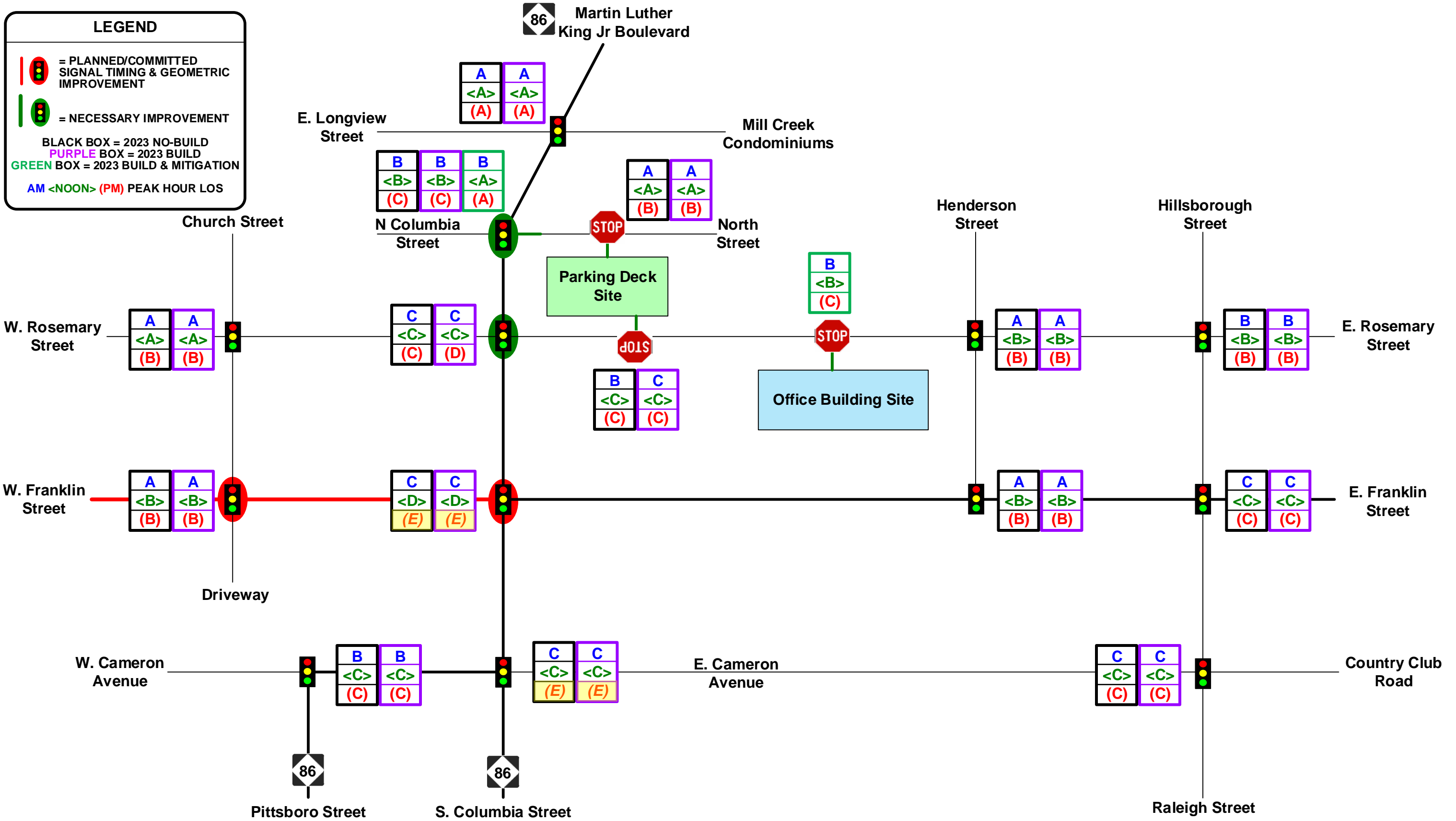

NOT TO SCALE

East Rosemary Street Parking Deck & Office Building
 Transportation Impact Analysis

2023 LEVEL OF SERVICE SUMMARY

DATE: September 2020

FIGURE 15

LEGEND

- = PLANNED/COMMITTED SIGNAL TIMING & GEOMETRIC IMPROVEMENT
- = NECESSARY IMPROVEMENT

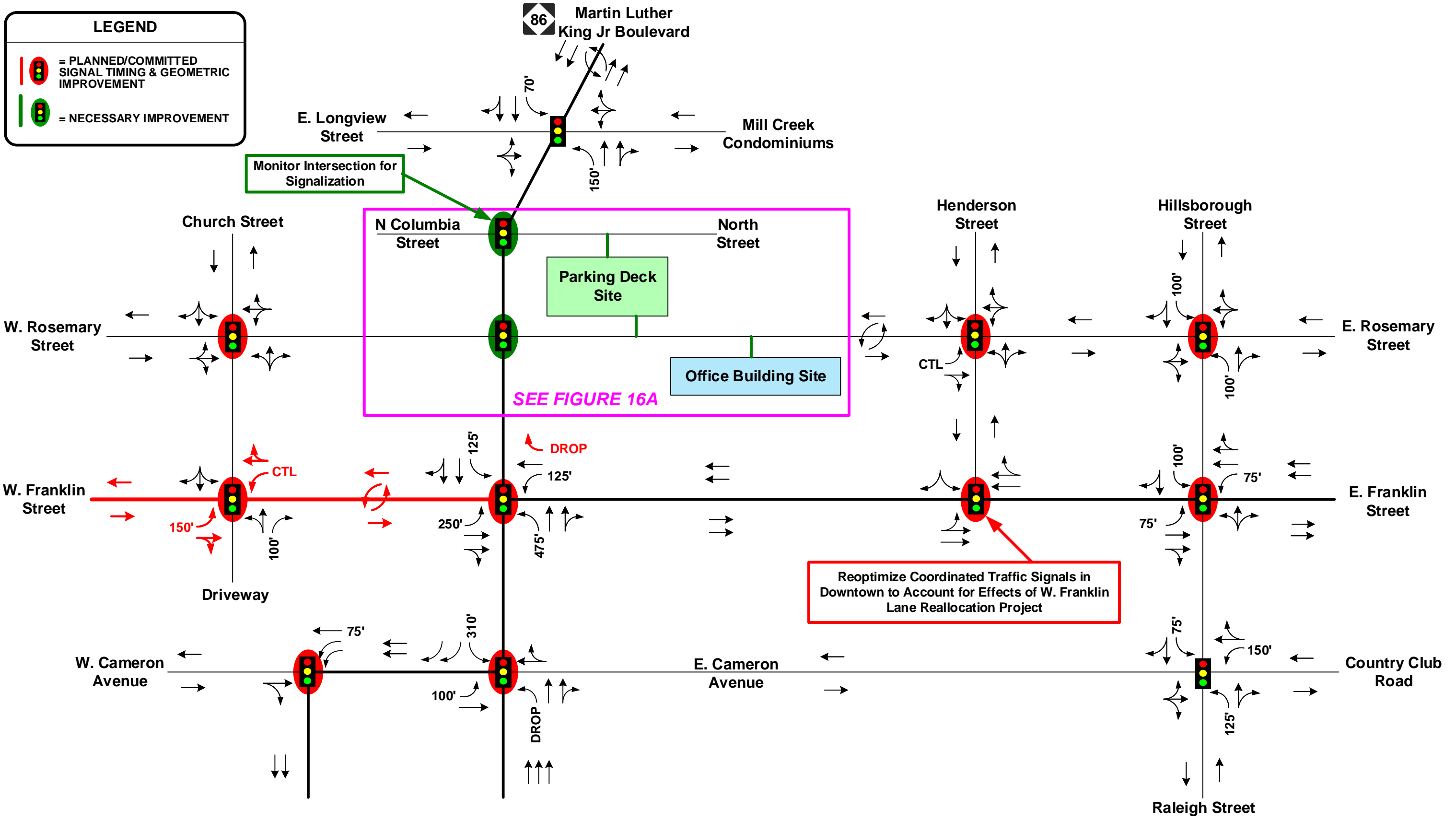

NOT TO SCALE

**East Rosemary Street Parking Deck & Office Building
Transportation Impact Analysis**

PLANNED, COMMITTED AND RECOMMENDED IMPROVEMENTS

DATE: September 2020

FIGURE 16

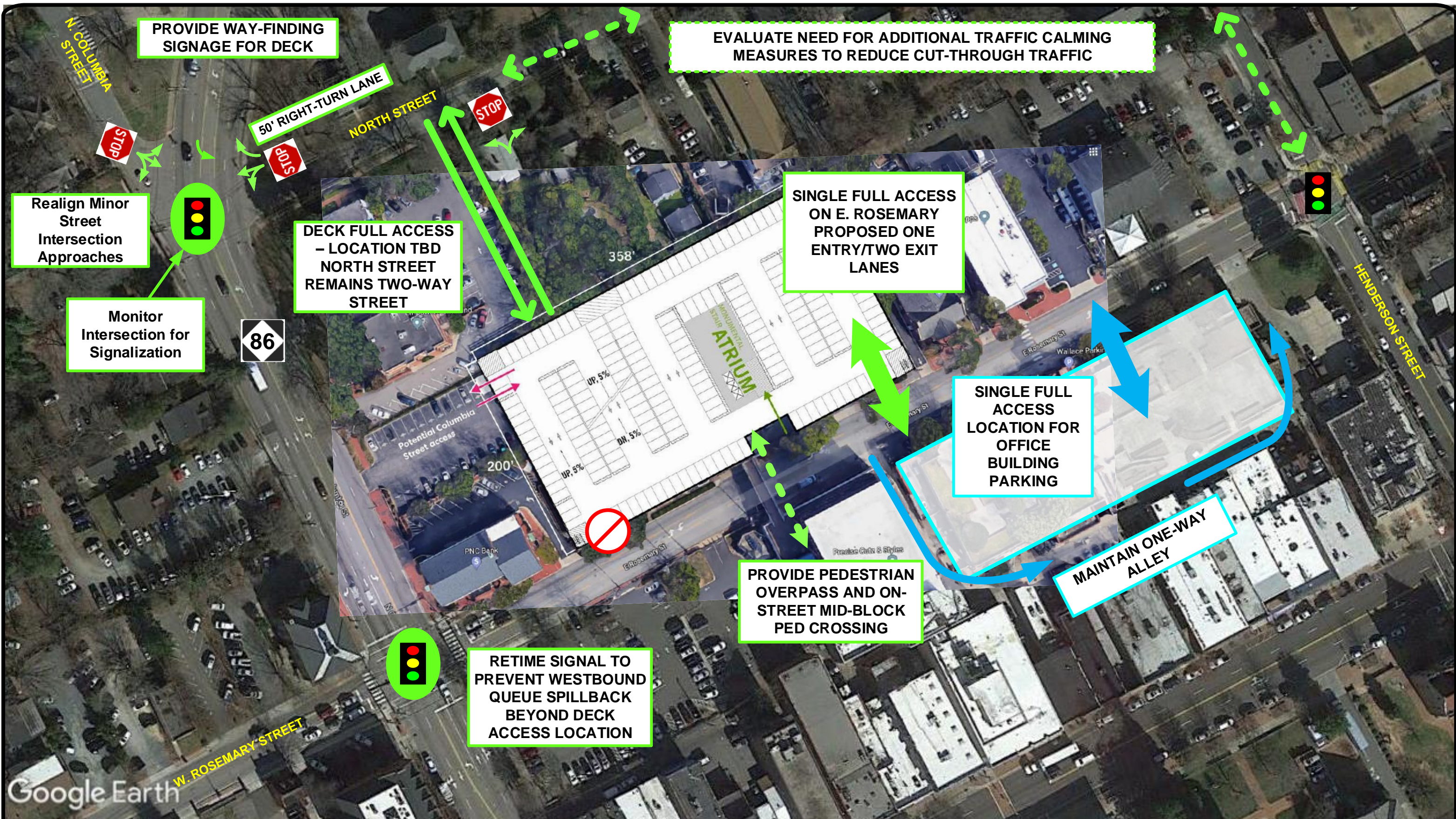



Appendix B – Traffic Count Data

LOCATION: MLK Jr Blvd -- Longview St
CITY/STATE: Chapel Hill, NC

QC JOB #: 15192501
DATE: Tue, Feb 25 2020

Peak-Hour: 7:30 AM -- 8:30 AM
 Peak 15-Min: 7:45 AM -- 8:00 AM

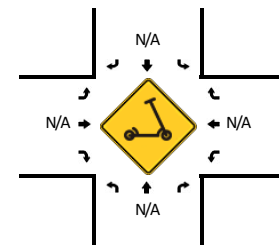
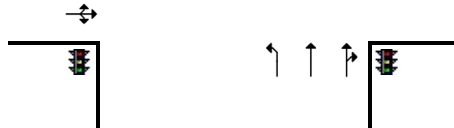
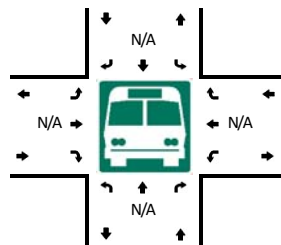
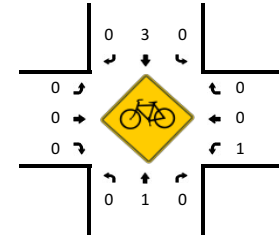
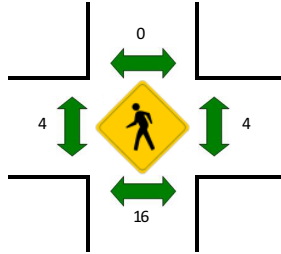
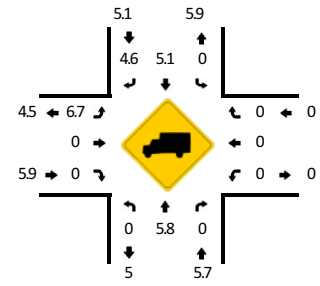
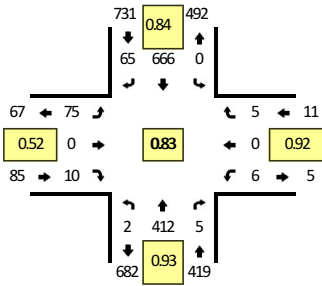

15-Min Count Period Beginning At	MLK Jr Blvd (Northbound)				MLK Jr Blvd (Southbound)				Longview St (Eastbound)				Longview St (Westbound)				Total	Hourly Totals
	Left	Thru	Right	U	Left	Thru	Right	U	Left	Thru	Right	U	Left	Thru	Right	U		
7:00 AM	0	69	1	0	0	98	10	0	5	0	2	0	2	0	3	0	190	
7:15 AM	0	59	1	0	0	151	21	0	11	0	9	0	0	0	0	0	252	
7:30 AM	0	94	1	0	0	174	26	0	17	0	3	0	0	0	2	0	317	
7:45 AM	0	111	2	0	0	194	24	0	35	0	6	0	2	0	1	0	375	1134
8:00 AM	1	98	1	0	0	155	6	0	12	0	1	0	3	0	0	0	277	1221
8:15 AM	1	109	1	0	0	143	9	0	11	0	0	0	1	0	2	0	277	1246
8:30 AM	0	98	1	0	0	183	7	0	17	0	4	0	2	0	3	0	315	1244
8:45 AM	0	88	2	0	0	212	11	0	21	1	2	0	2	1	0	0	340	1209

Peak 15-Min Flowrates	Northbound				Southbound				Eastbound				Westbound				Total
	Left	Thru	Right	U	Left	Thru	Right	U	Left	Thru	Right	U	Left	Thru	Right	U	
All Vehicles	0	444	8	0	0	776	96	0	140	0	24	0	8	0	4	0	1500
Heavy Trucks	0	16	0		0	20	4		0	0	0		0	0	0		40
Buses																	
Pedestrians		4				0				8				0			12
Bicycles	0	0	0		0	0	0		0	0	0		0	0	0		0
Scoters																	

Comments:

LOCATION: MLK Jr Blvd -- Longview St
CITY/STATE: Chapel Hill, NC

QC JOB #: 15192502
DATE: Tue, Feb 25 2020

Peak-Hour: 11:30 AM -- 12:30 PM
 Peak 15-Min: 12:00 PM -- 12:15 PM

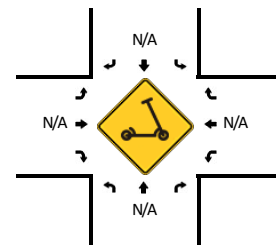
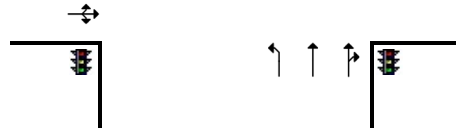
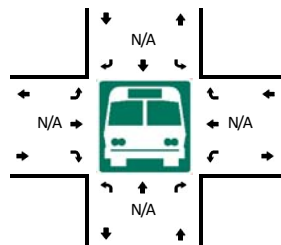
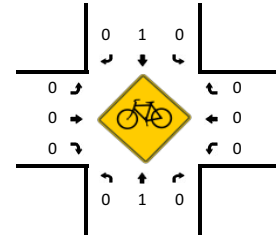
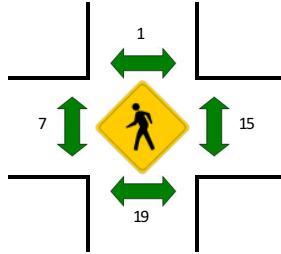
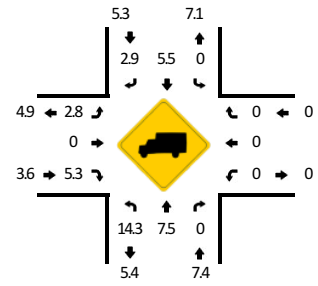
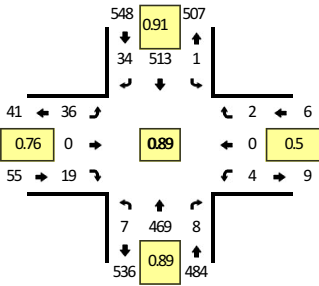

15-Min Count Period Beginning At	MLK Jr Blvd (Northbound)				MLK Jr Blvd (Southbound)				Longview St (Eastbound)				Longview St (Westbound)				Total	Hourly Totals
	Left	Thru	Right	U	Left	Thru	Right	U	Left	Thru	Right	U	Left	Thru	Right	U		
11:30 AM	1	117	2	0	1	111	5	0	10	0	4	0	2	0	0	0	253	
11:45 AM	4	109	4	0	0	124	8	0	2	0	6	0	0	0	1	0	258	
12:00 PM	1	135	0	0	0	137	12	0	12	0	6	0	2	0	1	0	306	
12:15 PM	1	108	2	0	0	141	9	0	12	0	3	0	0	0	0	0	276	1093
12:30 PM	1	107	1	0	0	119	7	0	10	0	0	0	0	0	1	0	246	1086
12:45 PM	4	126	1	0	0	104	9	0	13	0	1	0	0	0	1	0	259	1087
1:00 PM	3	118	0	1	0	121	7	0	7	0	3	0	1	0	0	0	261	1042
1:15 PM	3	119	3	0	1	112	5	0	5	0	4	0	0	0	0	0	252	1018

Peak 15-Min Flowrates	Northbound				Southbound				Eastbound				Westbound				Total
	Left	Thru	Right	U	Left	Thru	Right	U	Left	Thru	Right	U	Left	Thru	Right	U	
All Vehicles	4	540	0	0	0	548	48	0	48	0	24	0	8	0	4	0	1224
Heavy Trucks	0	36	0	0	0	28	0	0	0	0	0	0	0	0	0	0	64
Buses		40				0				8				16			64
Pedestrians		4	0			4	0			0	0			0	0		8
Bicycles																	
Scoters																	

Comments:

LOCATION: MLK Jr Blvd -- Longview St
CITY/STATE: Chapel Hill, NC

QC JOB #: 15192503
DATE: Wed, Feb 19 2020

Peak-Hour: 5:00 PM -- 6:00 PM
Peak 15-Min: 5:30 PM -- 5:45 PM

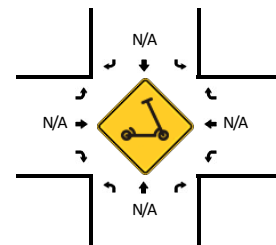
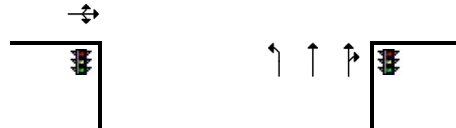
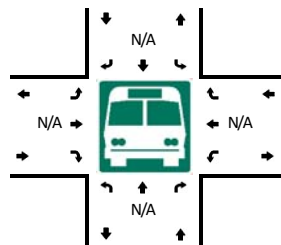
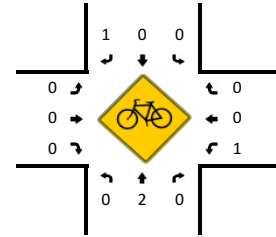
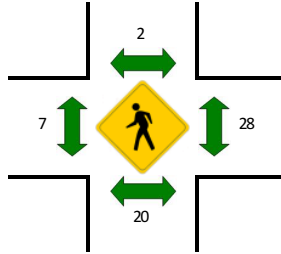
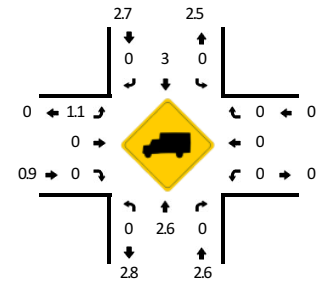
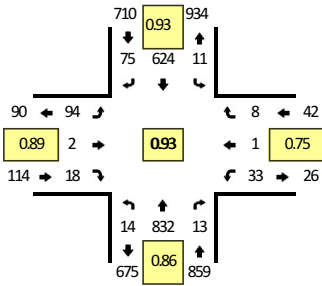

15-Min Count Period Beginning At	MLK Jr Blvd (Northbound)				MLK Jr Blvd (Southbound)				Longview St (Eastbound)				Longview St (Westbound)				Total	Hourly Totals
	Left	Thru	Right	U	Left	Thru	Right	U	Left	Thru	Right	U	Left	Thru	Right	U		
4:00 PM	2	216	7	0	1	106	13	0	21	0	3	0	4	1	1	0	375	
4:15 PM	4	172	3	0	3	118	14	0	18	2	4	0	4	0	2	0	344	
4:30 PM	4	176	3	0	8	139	14	0	23	0	2	0	3	0	7	0	379	
4:45 PM	3	209	2	0	1	133	15	0	17	0	8	0	8	0	0	0	396	1494
5:00 PM	3	178	3	0	4	169	18	0	22	0	6	0	7	1	2	0	413	1532
5:15 PM	6	223	3	0	5	149	16	0	24	0	4	0	5	0	2	0	437	1625
5:30 PM	4	240	5	0	0	152	19	0	28	1	3	0	13	0	1	0	466	1712
5:45 PM	1	191	2	0	2	154	22	0	20	1	5	0	8	0	3	0	409	1725

Peak 15-Min Flowrates	Northbound				Southbound				Eastbound				Westbound				Total
	Left	Thru	Right	U	Left	Thru	Right	U	Left	Thru	Right	U	Left	Thru	Right	U	
All Vehicles	16	960	20	0	0	608	76	0	112	4	12	0	52	0	4	0	1864
Heavy Trucks	0	16	0	0	0	28	0	0	4	0	0	0	0	0	0	0	48
Buses		20				0				12				36			68
Pedestrians		4				0				0				0			4
Bicycles																	
Scoters																	

Comments:

LOCATION: MLK Jr Blvd -- North St
CITY/STATE: Chapel Hill, NC

QC JOB #: 15192504
DATE: Tue, Feb 25 2020

Peak-Hour: 7:45 AM -- 8:45 AM
Peak 15-Min: 7:45 AM -- 8:00 AM

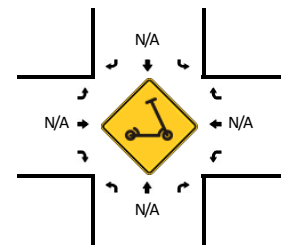
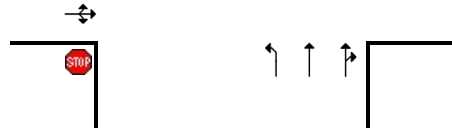
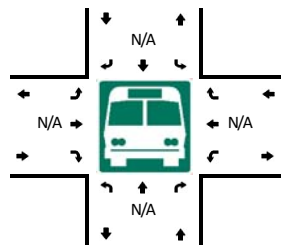
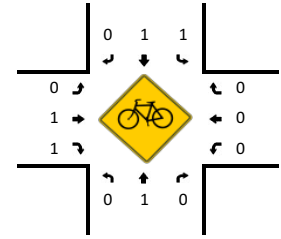
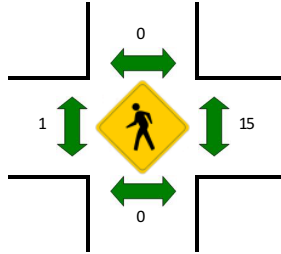
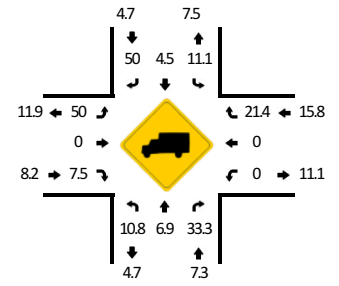
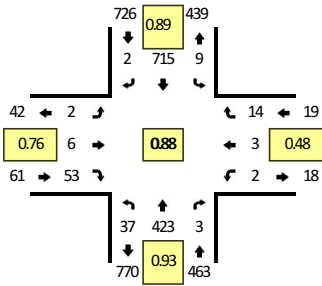

15-Min Count Period Beginning At	MLK Jr Blvd (Northbound)				MLK Jr Blvd (Southbound)				North St (Eastbound)				North St (Westbound)				Total	Hourly Totals	
	Left	Thru	Right	U	Left	Thru	Right	U	Left	Thru	Right	U	Left	Thru	Right	U			
7:00 AM	10	70	0	0	0	94	0	0	1	3	13	0	0	1	1	0	0	193	
7:15 AM	12	63	0	0	4	144	0	0	1	1	9	0	0	1	3	0	0	238	
7:30 AM	12	93	1	0	1	175	1	0	0	5	10	0	0	4	3	0	0	305	
7:45 AM	11	113	1	0	2	202	0	0	1	4	15	0	1	2	7	0	0	359	1095
8:00 AM	6	99	1	0	1	144	1	0	0	1	9	0	0	0	3	0	0	265	1167
8:15 AM	9	109	1	0	2	174	1	0	1	1	18	0	0	0	1	0	0	317	1246
8:30 AM	11	102	0	0	4	195	0	0	0	0	11	0	1	1	3	0	0	328	1269
8:45 AM	5	93	0	0	4	199	3	0	0	1	17	0	2	3	4	0	0	331	1241

Peak 15-Min Flowrates	Northbound				Southbound				Eastbound				Westbound				Total	
	Left	Thru	Right	U	Left	Thru	Right	U	Left	Thru	Right	U	Left	Thru	Right	U		
All Vehicles	44	452	4	0	8	808	0	0	4	16	60	0	4	8	28	0	0	1436
Heavy Trucks	8	20	0	0	0	28	0	0	4	0	4	0	0	0	4	0	0	68
Buses																		
Pedestrians		0				0				0				16				16
Bicycles	0	0	0		0	0	0		0	4	0		0	0	0			4
Scoters																		

Comments:

LOCATION: MLK Jr Blvd -- North St
CITY/STATE: Chapel Hill, NC

QC JOB #: 15192505
DATE: Tue, Feb 25 2020

Peak-Hour: 12:00 PM -- 1:00 PM
Peak 15-Min: 12:15 PM -- 12:30 PM

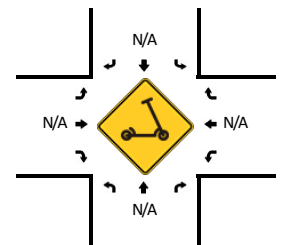
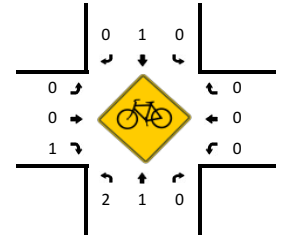
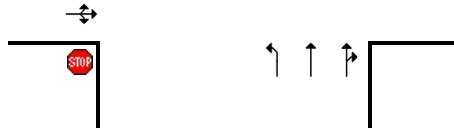
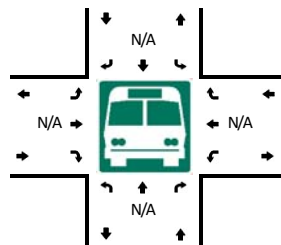
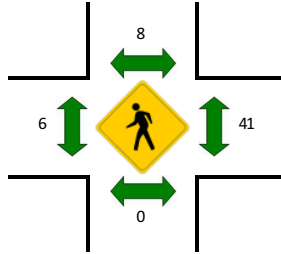
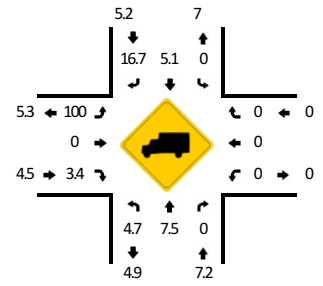
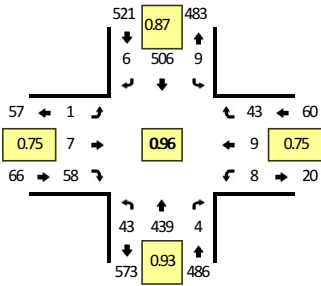

15-Min Count Period Beginning At	MLK Jr Blvd (Northbound)				MLK Jr Blvd (Southbound)				North St (Eastbound)				North St (Westbound)				Total	Hourly Totals
	Left	Thru	Right	U	Left	Thru	Right	U	Left	Thru	Right	U	Left	Thru	Right	U		
11:30 AM	8	115	2	0	2	116	0	0	0	0	4	0	4	0	6	0	257	
11:45 AM	8	96	2	0	3	127	2	1	0	2	14	0	0	3	9	0	267	
12:00 PM	7	104	0	1	2	146	2	0	0	0	11	0	3	4	13	0	293	
12:15 PM	13	105	1	0	2	137	1	0	1	2	19	0	2	3	8	0	294	1111
12:30 PM	9	113	3	0	1	116	0	0	0	2	15	0	1	0	12	0	272	1126
12:45 PM	13	117	0	0	4	107	3	0	0	3	13	0	2	2	10	0	274	1133
1:00 PM	10	125	4	1	2	114	2	0	0	5	6	0	4	2	4	0	279	1119
1:15 PM	10	113	0	1	1	107	3	0	0	0	16	0	1	1	7	0	260	1085
Peak 15-Min Flowrates	Northbound				Southbound				Eastbound				Westbound				Total	
	Left	Thru	Right	U	Left	Thru	Right	U	Left	Thru	Right	U	Left	Thru	Right	U		
All Vehicles	52	420	4	0	8	548	4	0	4	8	76	0	8	12	32	0	1176	
Heavy Trucks	4	28	0		0	32	0		4	0	0		0	0	0		68	
Buses																		
Pedestrians		0				16				8				56				80
Bicycles	8	0	0		0	0	0		0	0	0		0	0	0		8	
Scoters																		

Comments:

LOCATION: MLK Jr Blvd -- North St
CITY/STATE: Chapel Hill, NC

QC JOB #: 15192506
DATE: Wed, Feb 19 2020

Peak-Hour: 5:00 PM -- 6:00 PM
Peak 15-Min: 5:30 PM -- 5:45 PM

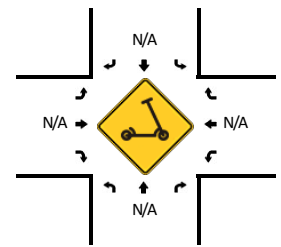
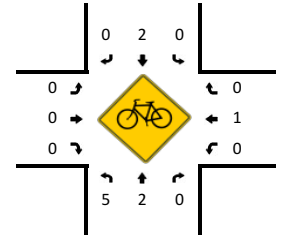
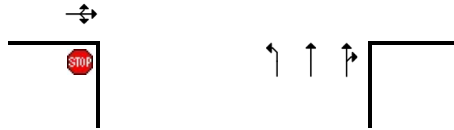
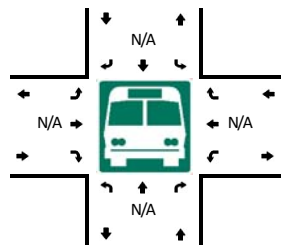
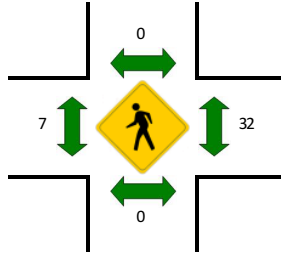
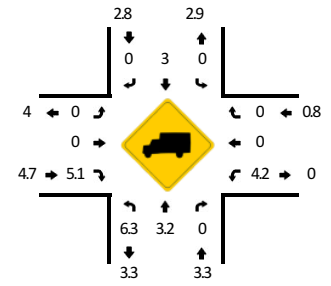
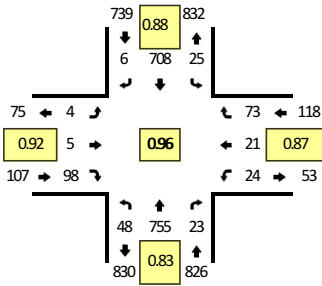

15-Min Count Period Beginning At	MLK Jr Blvd (Northbound)				MLK Jr Blvd (Southbound)				North St (Eastbound)				North St (Westbound)				Total	Hourly Totals
	Left	Thru	Right	U	Left	Thru	Right	U	Left	Thru	Right	U	Left	Thru	Right	U		
4:00 PM	8	200	2	0	1	114	3	0	0	0	14	0	1	2	10	0	355	
4:15 PM	11	172	1	0	3	131	0	0	2	1	17	0	2	2	11	0	353	
4:30 PM	13	175	1	0	2	160	3	0	0	1	15	0	5	6	8	0	389	
4:45 PM	16	183	2	0	5	145	0	0	0	4	21	0	2	3	15	0	396	1493
5:00 PM	11	167	3	0	6	202	1	0	0	1	27	0	9	4	21	0	452	1590
5:15 PM	9	197	9	0	4	170	3	0	1	1	23	0	3	5	19	0	444	1681
5:30 PM	17	224	7	0	7	155	0	0	1	3	21	0	6	11	16	0	468	1760
5:45 PM	11	167	4	0	8	181	2	0	2	0	27	0	6	1	17	0	426	1790

Peak 15-Min Flowrates	Northbound				Southbound				Eastbound				Westbound				Total
	Left	Thru	Right	U	Left	Thru	Right	U	Left	Thru	Right	U	Left	Thru	Right	U	
All Vehicles	68	896	28	0	28	620	0	0	4	12	84	0	24	44	64	0	1872
Heavy Trucks	8	16	0		0	32	0		0	0	4		0	0	0		60
Buses																	
Pedestrians		0				0				4				32			36
Bicycles	4	0	0		0	4	0		0	0	0		0	0	0		8
Scoters																	

Comments:

LOCATION: Church St -- W Rosemary St
CITY/STATE: Chapel Hill, NC

QC JOB #: 15192507
DATE: Tue, Feb 25 2020

Peak-Hour: 8:00 AM -- 9:00 AM
 Peak 15-Min: 8:00 AM -- 8:15 AM

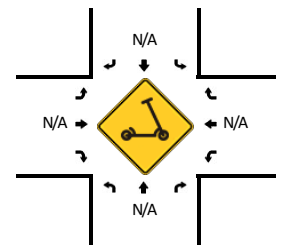
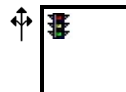
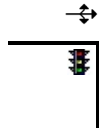
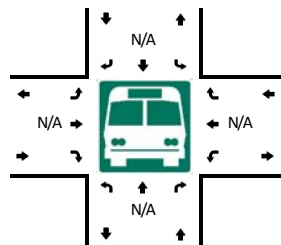
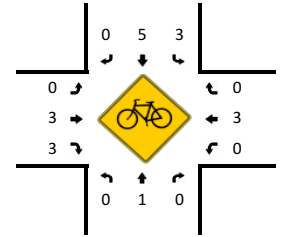
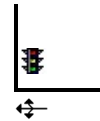
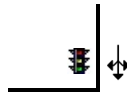
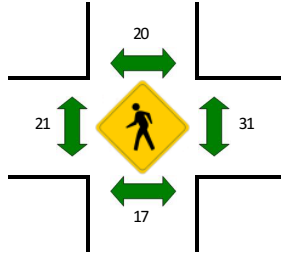
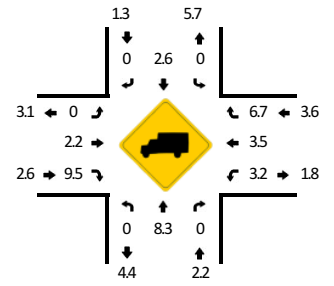
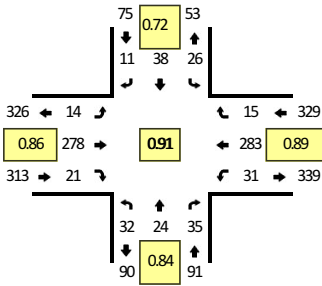

15-Min Count Period Beginning At	Church St (Northbound)				Church St (Southbound)				W Rosemary St (Eastbound)				W Rosemary St (Westbound)				Total	Hourly Totals
	Left	Thru	Right	U	Left	Thru	Right	U	Left	Thru	Right	U	Left	Thru	Right	U		
7:00 AM	2	2	1	0	7	2	1	0	1	30	0	0	3	25	6	0	80	
7:15 AM	2	6	2	0	8	9	3	0	5	33	1	0	4	44	5	0	122	
7:30 AM	3	12	8	0	6	13	5	0	6	61	2	0	4	44	10	0	174	
7:45 AM	2	3	4	0	11	17	0	0	1	80	4	0	14	54	7	0	197	573
8:00 AM	9	6	12	0	9	10	7	0	3	82	6	0	5	71	2	0	222	715
8:15 AM	10	2	7	0	6	10	2	0	3	64	4	0	9	58	6	0	181	774
8:30 AM	5	9	9	0	8	3	0	0	5	67	5	0	11	72	3	0	197	797
8:45 AM	8	7	7	0	3	15	2	0	3	65	6	0	6	82	4	0	208	808

Peak 15-Min Flowrates	Northbound				Southbound				Eastbound				Westbound				Total
	Left	Thru	Right	U	Left	Thru	Right	U	Left	Thru	Right	U	Left	Thru	Right	U	
All Vehicles	36	24	48	0	36	40	28	0	12	328	24	0	20	284	8	0	888
Heavy Trucks	0	0	0		0	4	0		0	0	4		0	4	0		12
Buses																	
Pedestrians		12				24				28				28			92
Bicycles	0	0	0		0	4	0		0	0	0		0	4	0		8
Scoters																	

Comments:

LOCATION: Church St -- W Rosemary St
CITY/STATE: Chapel Hill, NC

QC JOB #: 15192508
DATE: Tue, Feb 25 2020

Peak-Hour: 12:00 PM -- 1:00 PM
Peak 15-Min: 12:00 PM -- 12:15 PM

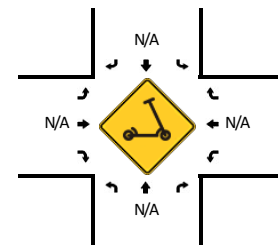
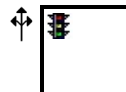
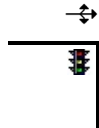
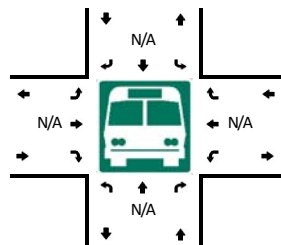
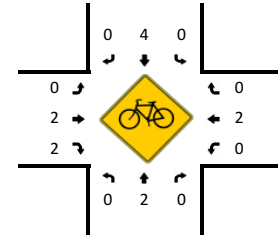
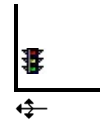
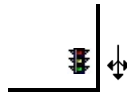
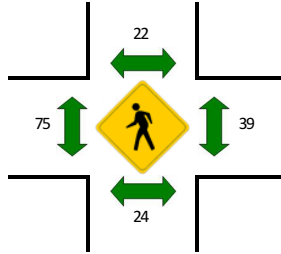
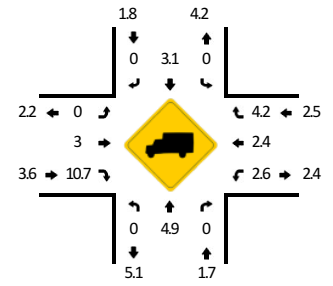
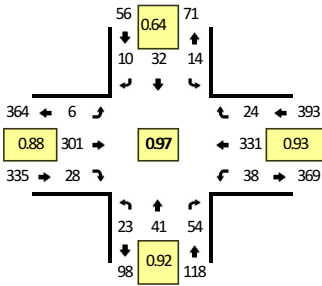

15-Min Count Period Beginning At	Church St (Northbound)				Church St (Southbound)				W Rosemary St (Eastbound)				W Rosemary St (Westbound)				Total	Hourly Totals	
	Left	Thru	Right	U	Left	Thru	Right	U	Left	Thru	Right	U	Left	Thru	Right	U			
11:30 AM	3	9	5	0	6	1	0	0	2	63	3	0	7	57	3	0	159		
11:45 AM	6	3	8	0	4	10	5	0	3	72	7	0	6	68	3	0	195		
12:00 PM	4	11	9	0	4	13	2	0	1	79	6	0	14	86	4	0	233		
12:15 PM	6	10	15	0	5	5	1	0	3	53	4	0	6	91	9	0	208	795	
12:30 PM	7	11	13	0	1	2	1	0	1	83	11	0	10	84	7	0	231	867	
12:45 PM	6	9	17	0	4	12	6	0	1	86	7	0	8	70	4	0	230	902	
1:00 PM	8	9	14	0	8	1	2	0	7	72	3	0	11	59	5	0	199	868	
1:15 PM	5	10	8	0	5	8	1	0	4	61	5	0	11	77	7	0	202	862	
Peak 15-Min Flowrates	Northbound				Southbound				Eastbound				Westbound				Total		
	Left	Thru	Right	U	Left	Thru	Right	U	Left	Thru	Right	U	Left	Thru	Right	U			
All Vehicles	16	44	36	0	16	52	8	0	4	316	24	0	56	344	16	0	932		
Heavy Trucks	0	4	0		0	0	0		0	12	4		0	8	0		28		
Buses																			
Pedestrians		12				16				68				52			148		
Bicycles	0	4	0		0	4	0		0	4	0		0	4	0		16		
Scoters																			

Comments:

LOCATION: Church St -- W Rosemary St
CITY/STATE: Chapel Hill, NC

QC JOB #: 15192509
DATE: Wed, Feb 19 2020

Peak-Hour: 5:00 PM -- 6:00 PM
Peak 15-Min: 5:00 PM -- 5:15 PM

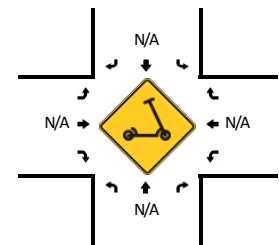
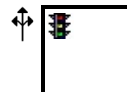
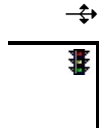
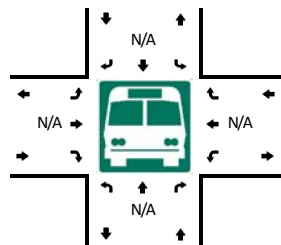
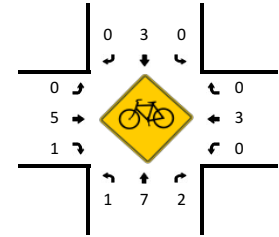
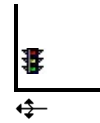
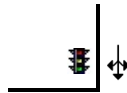
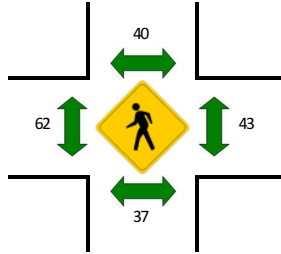
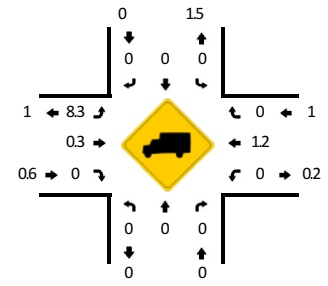
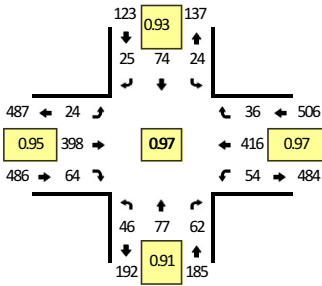

15-Min Count Period Beginning At	Church St (Northbound)				Church St (Southbound)				W Rosemary St (Eastbound)				W Rosemary St (Westbound)				Total	Hourly Totals
	Left	Thru	Right	U	Left	Thru	Right	U	Left	Thru	Right	U	Left	Thru	Right	U		
4:00 PM	11	8	15	0	5	11	2	0	5	79	8	0	8	77	5	0	234	
4:15 PM	8	13	7	0	8	8	3	0	5	74	7	0	11	72	6	0	222	
4:30 PM	12	7	12	0	9	17	6	0	3	87	6	0	15	83	9	0	266	
4:45 PM	17	9	11	0	3	12	6	0	2	91	11	0	8	100	5	0	275	997
5:00 PM	14	28	9	0	9	17	7	0	8	104	16	0	13	103	6	0	334	1097
5:15 PM	12	23	14	0	8	19	5	0	2	90	19	0	9	104	10	0	315	1190
5:30 PM	10	11	19	0	5	19	6	0	7	100	19	0	12	109	10	0	327	1251
5:45 PM	10	15	20	0	2	19	7	0	7	104	10	0	20	100	10	0	324	1300

Peak 15-Min Flowrates	Northbound				Southbound				Eastbound				Westbound				Total
	Left	Thru	Right	U	Left	Thru	Right	U	Left	Thru	Right	U	Left	Thru	Right	U	
All Vehicles	56	112	36	0	36	68	28	0	32	416	64	0	52	412	24	0	1336
Heavy Trucks	0	0	0	0	0	0	0	0	0	0	0	0	0	4	0	0	4
Buses																	
Pedestrians		68				40				96				56			260
Bicycles	4	4	0		0	0	0		0	4	0		0	4	0		16
Scoters																	

Comments:

LOCATION: N Columbia St -- W Rosemary St
CITY/STATE: Chapel Hill, NC

QC JOB #: 15192510
DATE: Tue, Feb 25 2020

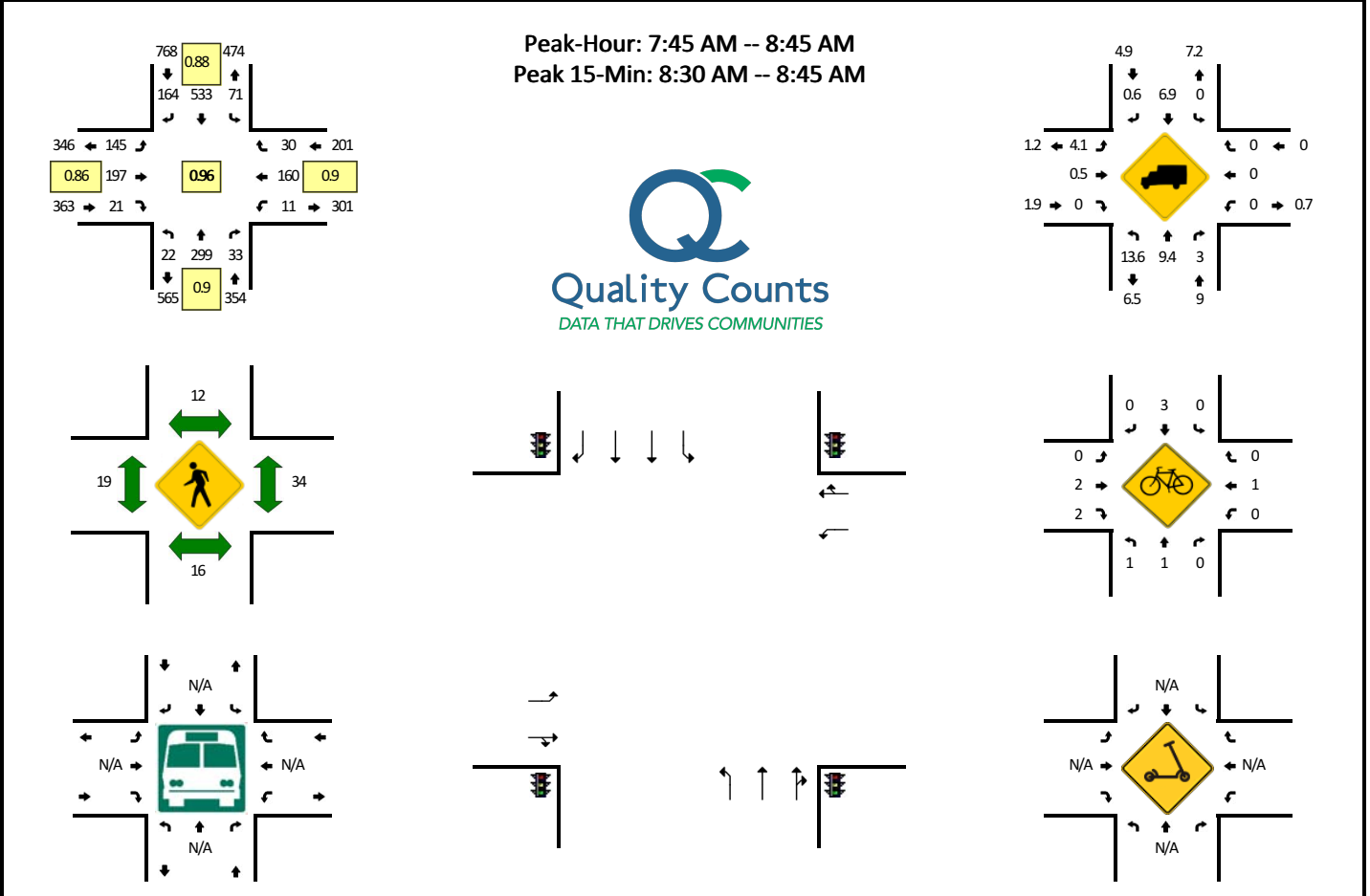

15-Min Count Period Beginning At	N Columbia St (Northbound)				N Columbia St (Southbound)				W Rosemary St (Eastbound)				W Rosemary St (Westbound)				Total	Hourly Totals
	Left	Thru	Right	U	Left	Thru	Right	U	Left	Thru	Right	U	Left	Thru	Right	U		
7:00 AM	6	64	3	0	13	80	18	0	12	22	2	0	2	14	6	0	242	
7:15 AM	4	57	3	0	9	112	31	0	10	30	2	0	4	19	7	0	288	
7:30 AM	5	88	2	0	10	141	30	0	19	43	10	0	1	32	5	0	386	
7:45 AM	1	71	6	0	23	145	42	0	47	53	5	0	2	37	7	0	439	1355
8:00 AM	4	69	8	0	7	121	36	0	33	54	5	0	2	41	13	0	393	1506
8:15 AM	6	86	6	0	20	119	37	0	27	55	3	0	5	42	7	0	413	1631
8:30 AM	11	73	13	0	21	148	49	0	38	35	8	0	2	40	3	0	441	1686
8:45 AM	7	74	13	0	20	133	43	0	21	41	9	0	5	51	8	0	425	1672
Peak 15-Min Flowrates	Northbound				Southbound				Eastbound				Westbound				Total	
	Left	Thru	Right	U	Left	Thru	Right	U	Left	Thru	Right	U	Left	Thru	Right	U		
All Vehicles	44	292	52	0	84	592	196	0	152	140	32	0	8	160	12	0	1764	
Heavy Trucks	8	36	4		0	44	4		8	4	0		0	0	0		108	
Buses																		
Pedestrians		12				8				28				36			84	
Bicycles	0	0	0		0	4	0		0	8	0		0	4	0		16	
Scoters																		

Comments:

LOCATION: N Columbia St -- W Rosemary St
CITY/STATE: Chapel Hill, NC

QC JOB #: 15192511
DATE: Tue, Feb 25 2020

Peak-Hour: 12:00 PM -- 1:00 PM
Peak 15-Min: 12:00 PM -- 12:15 PM

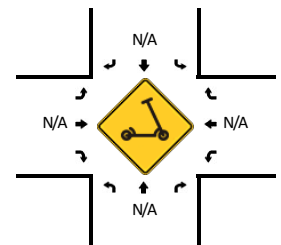
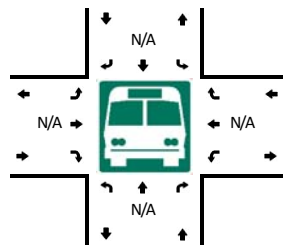
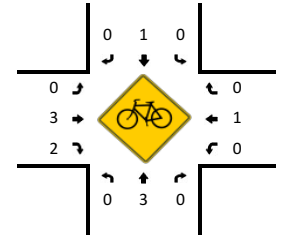
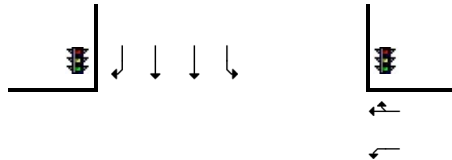
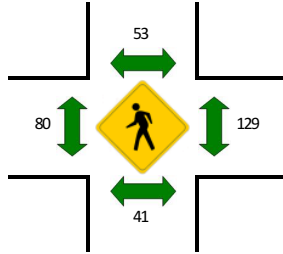
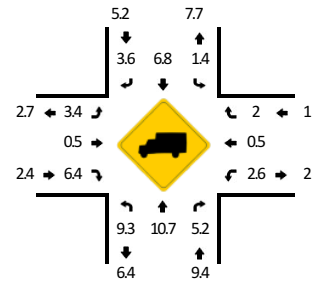
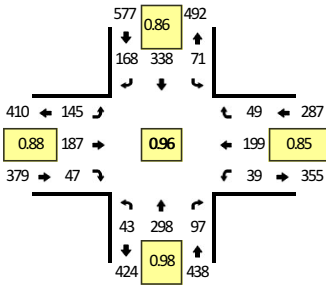

15-Min Count Period Beginning At	N Columbia St (Northbound)				N Columbia St (Southbound)				W Rosemary St (Eastbound)				W Rosemary St (Westbound)				Total	Hourly Totals
	Left	Thru	Right	U	Left	Thru	Right	U	Left	Thru	Right	U	Left	Thru	Right	U		
11:30 AM	6	88	13	0	10	88	33	0	25	42	4	0	3	34	4	0	350	
11:45 AM	8	79	26	0	17	88	41	0	21	50	10	0	12	38	8	0	398	
12:00 PM	7	75	26	0	22	97	48	0	32	53	9	0	8	49	13	0	439	
12:15 PM	9	76	25	0	12	84	47	0	28	39	9	0	13	56	15	0	413	1600
12:30 PM	16	70	22	0	20	87	41	0	46	43	12	0	10	43	8	0	418	1668
12:45 PM	11	77	24	0	17	70	32	0	39	52	17	0	8	51	13	0	411	1681
1:00 PM	6	95	30	0	12	85	31	0	35	46	13	0	10	39	7	0	409	1651
1:15 PM	12	81	12	0	18	80	31	0	31	45	7	0	12	55	12	0	396	1634
Peak 15-Min Flowrates	Northbound				Southbound				Eastbound				Westbound				Total	
	Left	Thru	Right	U	Left	Thru	Right	U	Left	Thru	Right	U	Left	Thru	Right	U		
All Vehicles	28	300	104	0	88	388	192	0	128	212	36	0	32	196	52	0	1756	
Heavy Trucks	4	32	8		0	20	12		4	4	4		0	0	0		88	
Buses																		
Pedestrians		32				48				76				124			280	
Bicycles	0	4	0		0	4	0		0	8	0		0	4	0		20	
Scoters																		

Comments:

LOCATION: N Columbia St -- W Rosemary St
CITY/STATE: Chapel Hill, NC

QC JOB #: 15192512
DATE: Wed, Feb 19 2020

Peak-Hour: 5:00 PM -- 6:00 PM
Peak 15-Min: 5:00 PM -- 5:15 PM

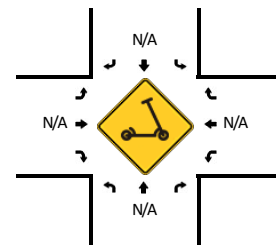
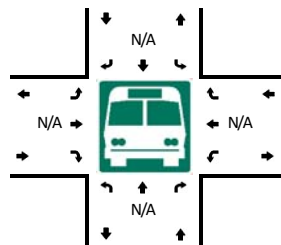
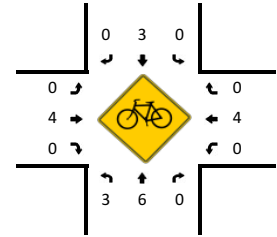
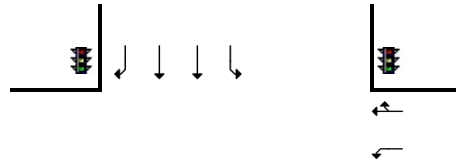
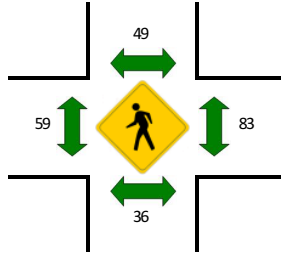
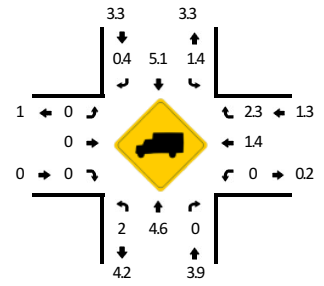
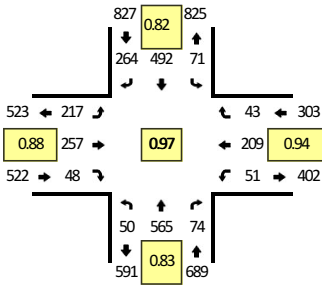

15-Min Count Period Beginning At	N Columbia St (Northbound)				N Columbia St (Southbound)				W Rosemary St (Eastbound)				W Rosemary St (Westbound)				Total	Hourly Totals
	Left	Thru	Right	U	Left	Thru	Right	U	Left	Thru	Right	U	Left	Thru	Right	U		
4:00 PM	9	136	20	1	8	82	35	0	61	48	6	0	12	43	11	0	472	
4:15 PM	8	135	18	0	11	90	48	0	33	47	8	0	8	38	15	0	459	
4:30 PM	16	129	19	0	19	96	62	0	44	60	6	0	4	30	13	0	498	
4:45 PM	13	136	9	0	18	103	48	0	48	57	12	0	17	53	17	0	531	1960
5:00 PM	14	124	19	0	16	156	80	0	47	68	13	0	9	45	11	0	602	2090
5:15 PM	12	141	21	0	18	103	64	0	62	66	20	0	16	51	13	0	587	2218
5:30 PM	10	181	16	0	19	105	60	0	56	63	7	0	14	53	10	0	594	2314
5:45 PM	14	119	18	0	18	128	60	0	52	60	8	0	12	60	9	0	558	2341

Peak 15-Min Flowrates	Northbound				Southbound				Eastbound				Westbound				Total
	Left	Thru	Right	U	Left	Thru	Right	U	Left	Thru	Right	U	Left	Thru	Right	U	
All Vehicles	56	496	76	0	64	624	320	0	188	272	52	0	36	180	44	0	2408
Heavy Trucks	0	8	0		4	36	4		0	0	0		0	4	0		56
Buses																	
Pedestrians		28				40				80				68			216
Bicycles	12	8	0		0	0	0		0	0	0		0	0	0		20
Scoters																	

Comments:

LOCATION: Henderson St -- Rosemary St
CITY/STATE: Chapel Hill, NC

QC JOB #: 15192513
DATE: Tue, Feb 25 2020

Peak-Hour: 8:00 AM -- 9:00 AM
 Peak 15-Min: 8:45 AM -- 9:00 AM

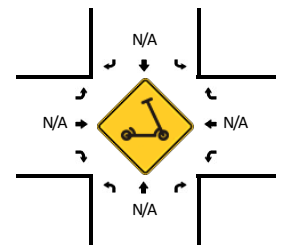
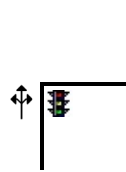
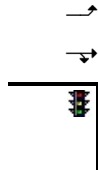
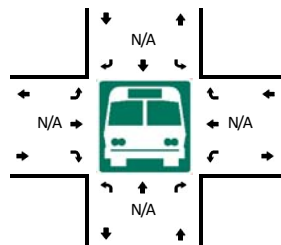
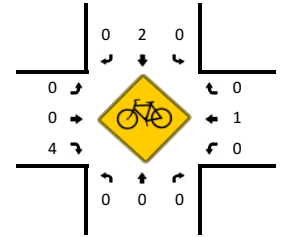
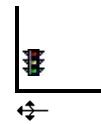
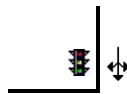
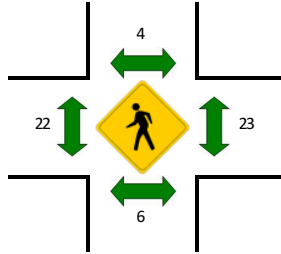
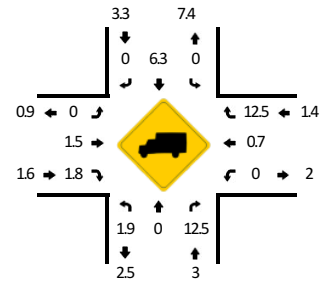
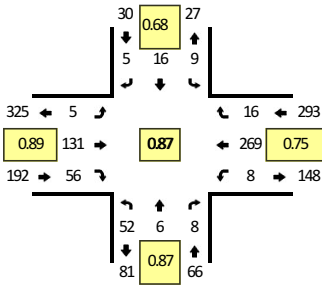

15-Min Count Period Beginning At	Henderson St (Northbound)				Henderson St (Southbound)				Rosemary St (Eastbound)				Rosemary St (Westbound)				Total	Hourly Totals
	Left	Thru	Right	U	Left	Thru	Right	U	Left	Thru	Right	U	Left	Thru	Right	U		
7:00 AM	5	0	1	0	3	1	0	0	0	21	8	0	1	29	2	0	71	
7:15 AM	3	2	0	0	4	1	0	0	0	22	5	0	0	26	4	0	67	
7:30 AM	9	2	1	0	5	3	0	0	1	22	21	0	2	39	11	0	116	
7:45 AM	13	3	1	0	5	5	1	0	3	38	12	0	1	54	9	0	145	399
8:00 AM	8	1	4	0	1	3	0	0	1	39	14	0	1	61	3	0	136	464
8:15 AM	14	0	1	0	2	5	1	0	0	37	14	0	4	64	5	0	147	544
8:30 AM	15	2	1	1	3	5	3	0	3	29	12	0	2	54	1	0	131	559
8:45 AM	14	3	2	0	3	3	1	0	1	26	16	0	1	90	7	0	167	581

Peak 15-Min Flowrates	Northbound				Southbound				Eastbound				Westbound				Total
	Left	Thru	Right	U	Left	Thru	Right	U	Left	Thru	Right	U	Left	Thru	Right	U	
All Vehicles	56	12	8	0	12	12	4	0	4	104	64	0	4	360	28	0	668
Heavy Trucks	4	0	0		0	0	0		0	0	0		0	4	0		8
Buses																	
Pedestrians		0				8				44				60			112
Bicycles	0	0	0		0	4	0		0	0	8		0	0	0		12
Scoters																	

Comments:

LOCATION: Henderson St -- Rosemary St
CITY/STATE: Chapel Hill, NC

QC JOB #: 15192514
DATE: Tue, Feb 25 2020

Peak-Hour: 11:45 AM -- 12:45 PM
Peak 15-Min: 12:00 PM -- 12:15 PM

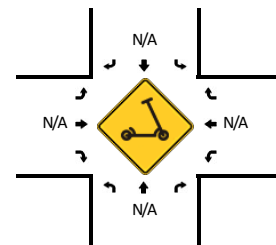
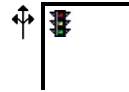
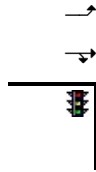
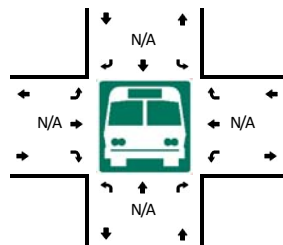
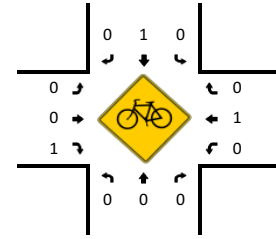
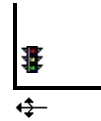
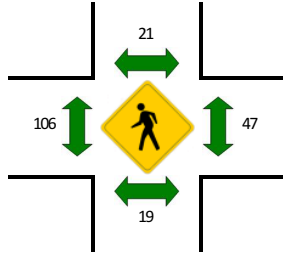
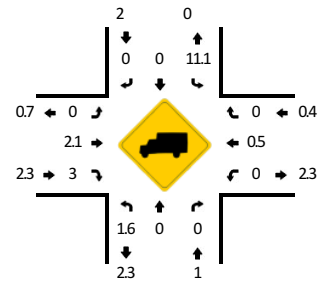
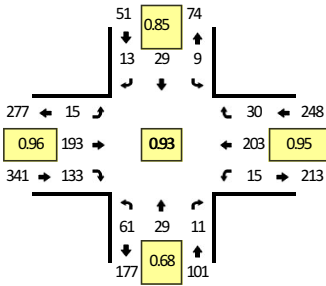

15-Min Count Period Beginning At	Henderson St (Northbound)				Henderson St (Southbound)				Rosemary St (Eastbound)				Rosemary St (Westbound)				Total	Hourly Totals
	Left	Thru	Right	U	Left	Thru	Right	U	Left	Thru	Right	U	Left	Thru	Right	U		
11:30 AM	13	6	4	0	7	5	2	0	1	41	11	0	3	34	8	0	135	
11:45 AM	15	12	2	0	3	8	4	0	5	57	27	0	4	52	7	0	196	
12:00 PM	21	11	5	0	1	11	3	0	3	49	35	0	2	50	9	0	200	
12:15 PM	12	1	2	0	3	5	3	0	3	45	34	0	5	54	6	0	173	704
12:30 PM	13	5	2	0	2	5	3	0	4	42	37	0	4	47	8	0	172	741
12:45 PM	21	5	3	0	6	8	1	0	5	40	29	0	1	44	7	0	170	715
1:00 PM	12	4	5	0	7	8	3	0	5	49	28	0	2	47	6	0	176	691
1:15 PM	13	7	4	0	3	9	2	0	4	38	30	0	6	57	9	0	182	700

Peak 15-Min Flowrates	Northbound				Southbound				Eastbound				Westbound				Total
	Left	Thru	Right	U	Left	Thru	Right	U	Left	Thru	Right	U	Left	Thru	Right	U	
All Vehicles	84	44	20	0	4	44	12	0	12	196	140	0	8	200	36	0	800
Heavy Trucks	0	0	0		0	0	0		0	8	4		0	0	0		12
Buses																	
Pedestrians		20				16				80				52			168
Bicycles	0	0	0		0	0	0		0	0	4		0	0	0		4
Scoters																	

Comments:

LOCATION: Henderson St -- Rosemary St
CITY/STATE: Chapel Hill, NC

QC JOB #: 15192515
DATE: Wed, Feb 19 2020

Peak-Hour: 4:45 PM -- 5:45 PM
 Peak 15-Min: 5:00 PM -- 5:15 PM

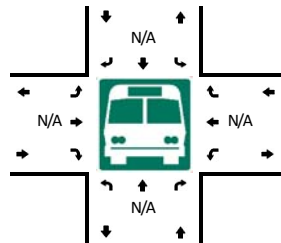
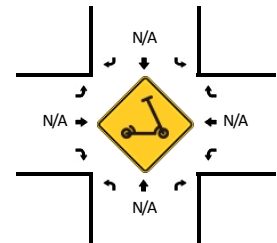
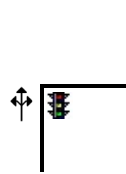
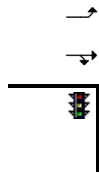
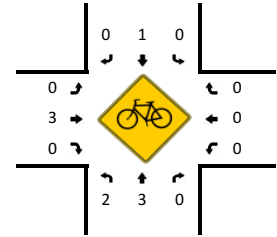
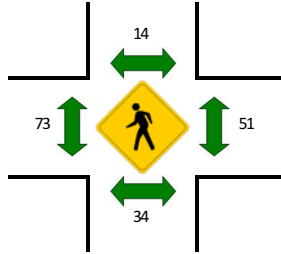
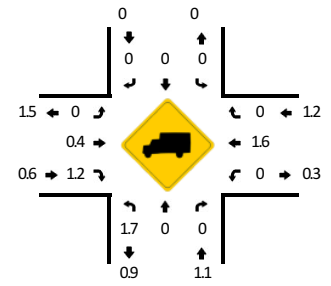
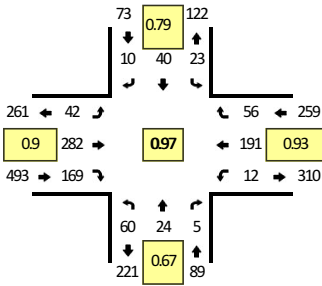

15-Min Count Period Beginning At	Henderson St (Northbound)				Henderson St (Southbound)				Rosemary St (Eastbound)				Rosemary St (Westbound)				Total	Hourly Totals	
	Left	Thru	Right	U	Left	Thru	Right	U	Left	Thru	Right	U	Left	Thru	Right	U			
4:00 PM	12	3	1	0	0	3	2	0	2	59	26	0	1	27	4	0	140		
4:15 PM	6	7	3	0	0	2	0	0	6	53	30	0	3	32	6	0	148		
4:30 PM	9	4	3	0	2	7	2	0	4	59	37	0	4	41	10	0	182		
4:45 PM	13	4	1	0	6	2	2	0	5	76	41	0	2	54	10	0	216	686	
5:00 PM	13	4	1	0	4	15	3	0	16	73	48	0	3	43	12	0	235	781	
5:15 PM	12	7	1	0	4	14	0	0	12	72	45	0	0	52	13	0	232	865	
5:30 PM	22	9	2	0	9	9	5	0	9	61	35	0	7	42	21	0	231	914	
5:45 PM	11	8	4	1	4	7	3	0	5	57	32	0	4	57	20	0	213	911	
Peak 15-Min Flowrates	Northbound				Southbound				Eastbound				Westbound				Total		
	Left	Thru	Right	U	Left	Thru	Right	U	Left	Thru	Right	U	Left	Thru	Right	U			
All Vehicles	52	16	4	0	16	60	12	0	64	292	192	0	12	172	48	0	940		
Heavy Trucks	0	0	0		0	0	0		0	4	4		0	4	0		12		
Buses																			
Pedestrians		16				8				100				60			184		
Bicycles	0	0	0		0	0	0		0	0	0		0	0	0		0		
Scoters																			

Comments:

LOCATION: Henderson St -- Franklin St
CITY/STATE: Chapel Hill, NC

QC JOB #: 15192516
DATE: Tue, Feb 25 2020

Peak-Hour: 8:00 AM -- 9:00 AM
Peak 15-Min: 8:30 AM -- 8:45 AM

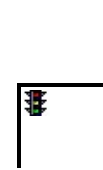
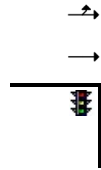
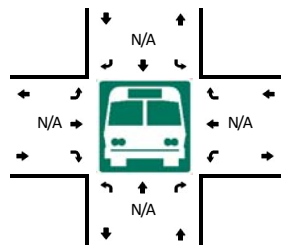
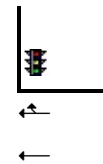
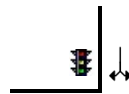
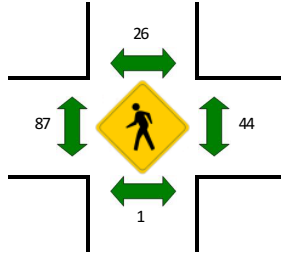
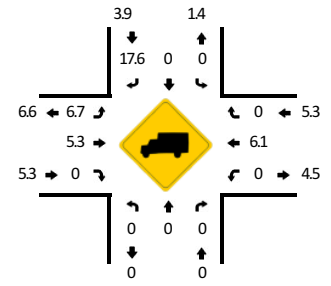
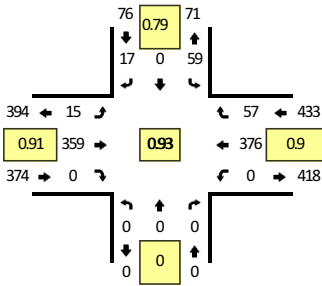

15-Min Count Period Beginning At	Henderson St (Northbound)				Henderson St (Southbound)				Franklin St (Eastbound)				Franklin St (Westbound)				Total	Hourly Totals
	Left	Thru	Right	U	Left	Thru	Right	U	Left	Thru	Right	U	Left	Thru	Right	U		
7:00 AM	0	0	0	0	8	0	2	0	2	21	0	0	0	51	6	0	90	
7:15 AM	0	0	0	0	3	0	1	0	1	41	0	0	0	48	2	0	96	
7:30 AM	0	0	0	0	16	0	3	0	4	67	0	0	0	61	8	0	159	
7:45 AM	0	0	0	0	15	0	4	0	8	81	0	0	0	85	10	0	203	548
8:00 AM	0	0	0	0	18	0	2	0	5	81	0	1	0	73	8	0	188	646
8:15 AM	0	0	0	0	18	0	6	0	3	93	0	0	0	99	14	0	233	783
8:30 AM	0	0	0	0	9	0	6	0	2	101	0	0	0	100	19	0	237	861
8:45 AM	0	0	0	0	14	0	3	0	4	84	0	0	0	104	16	0	225	883

Peak 15-Min Flowrates	Northbound				Southbound				Eastbound				Westbound				Total
	Left	Thru	Right	U	Left	Thru	Right	U	Left	Thru	Right	U	Left	Thru	Right	U	
All Vehicles	0	0	0	0	36	0	24	0	8	404	0	0	0	400	76	0	948
Heavy Trucks	0	0	0	0	0	0	4	0	0	20	0	0	0	36	0	0	60
Buses																	
Pedestrians		0				44				72				28			144
Bicycles	0	0	0		4	0	4		0	0	0		0	4	0		12
Scoters																	

Comments:

LOCATION: Henderson St -- Franklin St
CITY/STATE: Chapel Hill, NC

QC JOB #: 15192517
DATE: Tue, Feb 25 2020

Peak-Hour: 11:45 AM -- 12:45 PM
Peak 15-Min: 12:00 PM -- 12:15 PM

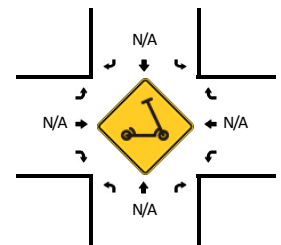
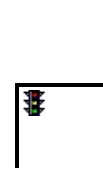
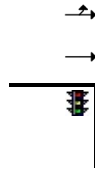
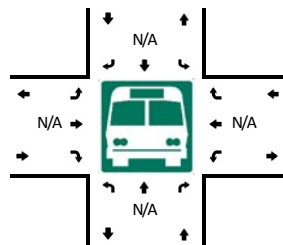
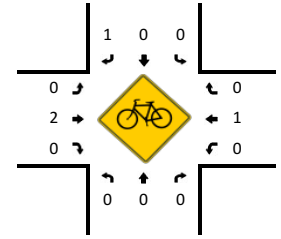
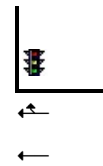
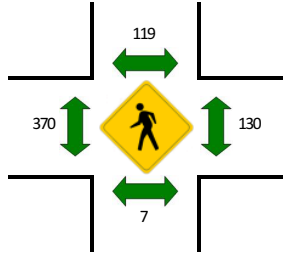
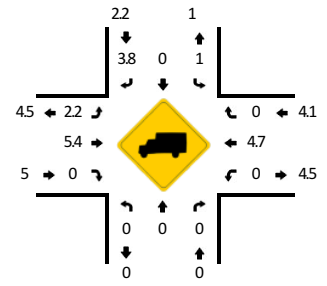
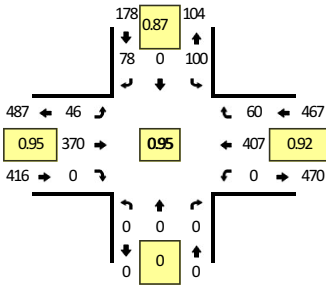

15-Min Count Period Beginning At	Henderson St (Northbound)				Henderson St (Southbound)				Franklin St (Eastbound)				Franklin St (Westbound)				Total	Hourly Totals
	Left	Thru	Right	U	Left	Thru	Right	U	Left	Thru	Right	U	Left	Thru	Right	U		
11:30 AM	0	0	0	0	12	0	4	0	7	76	0	0	0	77	12	0	188	
11:45 AM	0	0	0	0	18	0	19	0	12	84	0	0	0	110	17	0	260	
12:00 PM	0	0	0	0	29	0	17	0	16	93	0	1	0	103	21	0	280	
12:15 PM	0	0	0	0	29	0	22	0	9	95	0	0	0	98	9	0	262	990
12:30 PM	0	0	0	0	24	0	20	0	7	98	0	1	0	96	13	0	259	1061
12:45 PM	0	0	0	0	21	0	17	0	9	102	0	0	0	88	17	0	254	1055
1:00 PM	0	0	0	0	20	0	14	0	11	87	0	1	0	93	9	0	235	1010
1:15 PM	0	0	0	0	26	0	21	0	12	77	0	0	0	74	12	0	222	970

Peak 15-Min Flowrates	Northbound				Southbound				Eastbound				Westbound				Total
	Left	Thru	Right	U	Left	Thru	Right	U	Left	Thru	Right	U	Left	Thru	Right	U	
All Vehicles	0	0	0	0	116	0	68	0	64	372	0	4	0	412	84	0	1120
Heavy Trucks	0	0	0	0	4	0	0	0	0	20	0	0	0	16	0	0	40
Buses																	
Pedestrians		8				96				316				164			584
Bicycles	0	0	0		0	0	0		0	4	0		0	0	0		4
Scoters																	

Comments:

LOCATION: Henderson St -- Franklin St
CITY/STATE: Chapel Hill, NC

QC JOB #: 15192518
DATE: Wed, Feb 19 2020

Peak-Hour: 5:00 PM -- 6:00 PM
Peak 15-Min: 5:15 PM -- 5:30 PM

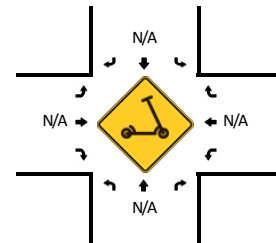
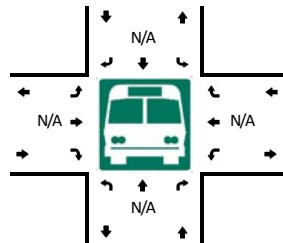
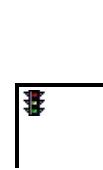
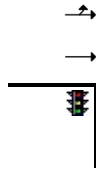
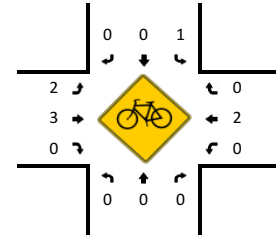
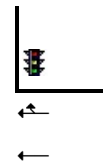
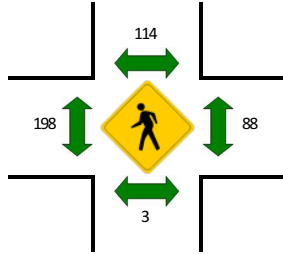
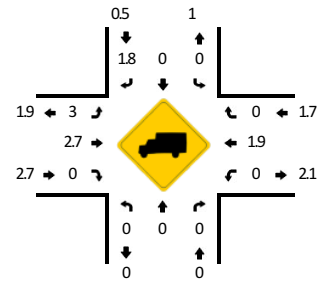
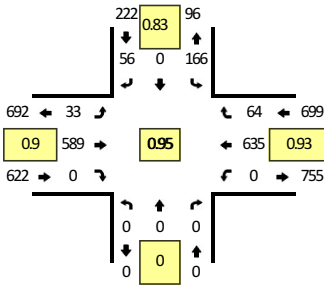

15-Min Count Period Beginning At	Henderson St (Northbound)				Henderson St (Southbound)				Franklin St (Eastbound)				Franklin St (Westbound)				Total	Hourly Totals
	Left	Thru	Right	U	Left	Thru	Right	U	Left	Thru	Right	U	Left	Thru	Right	U		
4:00 PM	0	0	0	0	23	0	7	0	5	109	0	1	0	121	11	0	277	
4:15 PM	0	0	0	0	24	0	9	0	5	117	0	0	0	126	8	0	289	
4:30 PM	0	0	0	0	39	0	12	0	4	116	0	0	0	124	14	0	309	
4:45 PM	0	0	0	0	34	0	14	0	9	128	0	0	0	151	10	0	346	1221
5:00 PM	0	0	0	0	56	0	11	0	4	134	0	0	0	146	13	0	364	1308
5:15 PM	0	0	0	0	48	0	14	0	8	161	0	0	0	159	14	0	404	1423
5:30 PM	0	0	0	0	36	0	10	0	12	159	0	1	0	158	22	0	398	1512
5:45 PM	0	0	0	0	26	0	21	0	8	135	0	0	0	172	15	0	377	1543
Peak 15-Min Flowrates	Northbound				Southbound				Eastbound				Westbound				Total	
	Left	Thru	Right	U	Left	Thru	Right	U	Left	Thru	Right	U	Left	Thru	Right	U		
All Vehicles	0	0	0	0	192	0	56	0	32	644	0	0	0	636	56	0	1616	
Heavy Trucks	0	0	0	0	0	0	0	0	4	12	0	0	0	8	0	0	24	
Buses																		
Pedestrians		0				116				136				104			356	
Bicycles	0	0	0		0	0	0		4	0	0		0	4	0		8	
Scoters																		

Comments:

LOCATION: Hillsborough St/Raleigh St -- Franklin St
CITY/STATE: Chapel Hill, NC

QC JOB #: 15192519
DATE: Tue, Feb 25 2020

Peak-Hour: 8:00 AM -- 9:00 AM
Peak 15-Min: 8:15 AM -- 8:30 AM

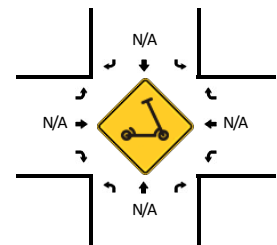
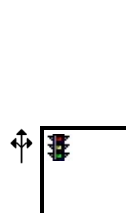
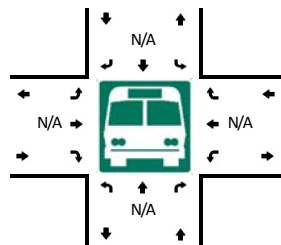
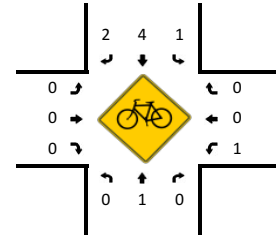
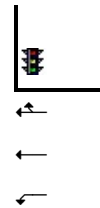
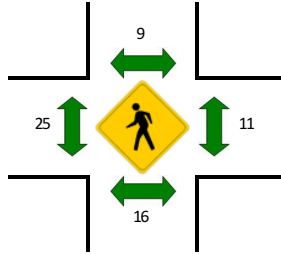
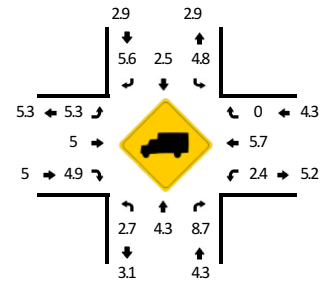
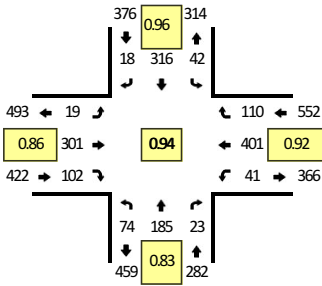

15-Min Count Period Beginning At	Hillsborough St/Raleigh St (Northbound)				Hillsborough St/Raleigh St (Southbound)				Franklin St (Eastbound)				Franklin St (Westbound)				Total	Hourly Totals
	Left	Thru	Right	U	Left	Thru	Right	U	Left	Thru	Right	U	Left	Thru	Right	U		
7:00 AM	8	37	4	0	7	43	4	0	2	18	15	0	5	44	20	0	207	
7:15 AM	4	25	3	0	7	60	1	0	0	31	12	0	6	54	14	0	217	
7:30 AM	7	39	0	0	10	84	3	0	1	49	34	0	8	70	15	0	320	
7:45 AM	9	46	5	0	14	85	3	0	1	64	31	0	16	85	27	0	386	1130
8:00 AM	9	41	5	0	10	80	5	0	2	82	20	0	11	80	28	0	373	1296
8:15 AM	19	52	5	0	10	78	6	0	10	84	28	0	8	105	29	0	434	1513
8:30 AM	17	46	3	0	10	77	2	0	3	70	31	0	14	106	30	0	409	1602
8:45 AM	29	46	10	0	12	81	5	0	4	65	23	0	8	110	23	0	416	1632
Peak 15-Min Flowrates	Northbound				Southbound				Eastbound				Westbound				Total	
	Left	Thru	Right	U	Left	Thru	Right	U	Left	Thru	Right	U	Left	Thru	Right	U		
All Vehicles	76	208	20	0	40	312	24	0	40	336	112	0	32	420	116	0	1736	
Heavy Trucks	0	4	4		4	8	4		4	8	8		0	28	0		72	
Buses		24				8				32				32			96	
Pedestrians		24				8				32				32			96	
Bicycles	0	4	0		4	8	0		0	0	0		0	0	0		16	
Scoters																		

Comments:

LOCATION: Hillsborough St/Raleigh St -- Franklin St
CITY/STATE: Chapel Hill, NC

QC JOB #: 15192520
DATE: Tue, Feb 25 2020

Peak-Hour: 12:00 PM -- 1:00 PM
Peak 15-Min: 12:15 PM -- 12:30 PM

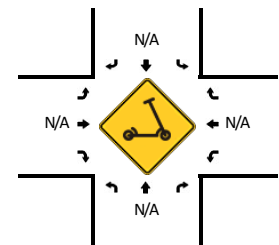
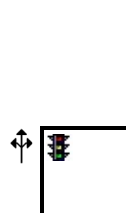
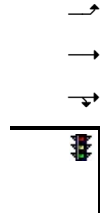
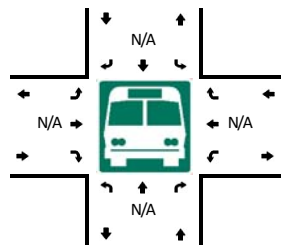
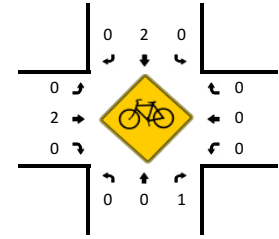
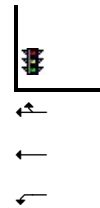
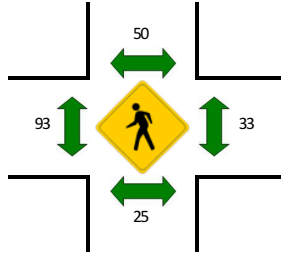
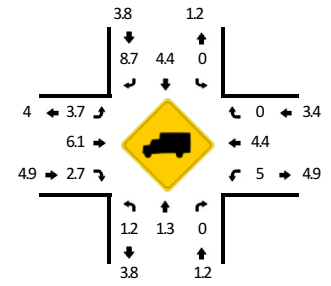
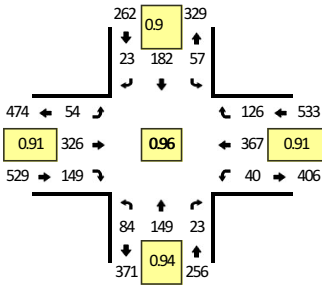

15-Min Count Period Beginning At	Hillsborough St/Raleigh St (Northbound)				Hillsborough St/Raleigh St (Southbound)				Franklin St (Eastbound)				Franklin St (Westbound)				Total	Hourly Totals
	Left	Thru	Right	U	Left	Thru	Right	U	Left	Thru	Right	U	Left	Thru	Right	U		
11:30 AM	14	36	5	0	17	37	4	0	7	62	24	0	9	72	16	0	303	
11:45 AM	20	38	2	0	22	54	9	0	8	57	27	0	9	97	30	0	373	
12:00 PM	25	30	4	0	16	43	6	0	12	68	42	0	9	106	31	0	392	
12:15 PM	26	33	6	0	18	47	8	0	15	90	41	0	10	79	37	0	410	1478
12:30 PM	11	44	9	0	13	46	4	0	15	83	33	0	11	91	33	0	393	1568
12:45 PM	22	42	4	0	10	46	5	0	12	85	33	0	10	91	25	0	385	1580
1:00 PM	14	51	4	0	14	45	3	0	7	83	32	0	11	87	21	0	372	1560
1:15 PM	13	33	3	0	17	48	9	0	9	79	21	0	10	69	39	0	350	1500
Peak 15-Min Flowrates	Northbound				Southbound				Eastbound				Westbound				Total	
	Left	Thru	Right	U	Left	Thru	Right	U	Left	Thru	Right	U	Left	Thru	Right	U		
All Vehicles	104	132	24	0	72	188	32	0	60	360	164	0	40	316	148	0	1640	
Heavy Trucks	0	4	0		0	4	4		0	24	4		0	24	0		64	
Buses																		
Pedestrians		36				92				152				56			336	
Bicycles	0	0	4		0	8	0		0	0	0		0	0	0		12	
Scoters																		

Comments:

LOCATION: Hillsborough St/Raleigh St -- Franklin St
CITY/STATE: Chapel Hill, NC

QC JOB #: 15192521
DATE: Wed, Feb 19 2020

Peak-Hour: 5:00 PM -- 6:00 PM
Peak 15-Min: 5:30 PM -- 5:45 PM

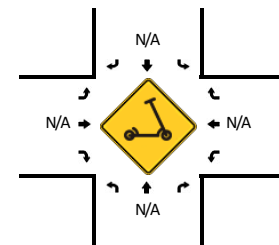
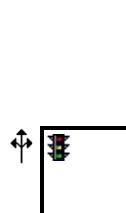
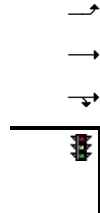
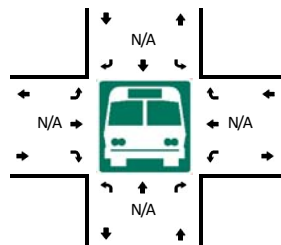
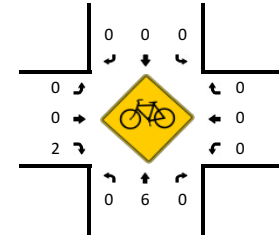
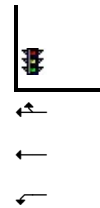
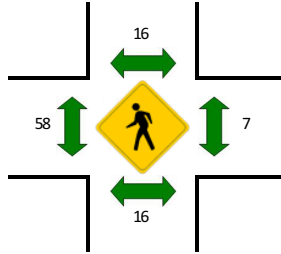
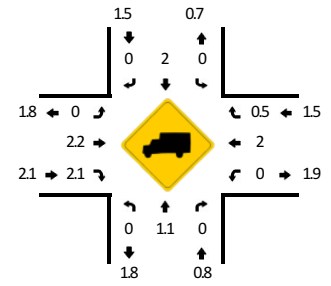
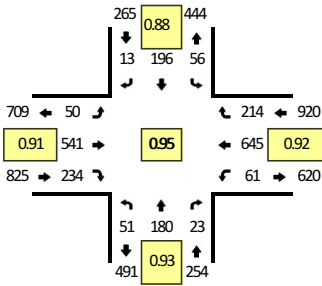

15-Min Count Period Beginning At	Hillsborough St/Raleigh St (Northbound)				Hillsborough St/Raleigh St (Southbound)				Franklin St (Eastbound)				Franklin St (Westbound)				Total	Hourly Totals
	Left	Thru	Right	U	Left	Thru	Right	U	Left	Thru	Right	U	Left	Thru	Right	U		
4:00 PM	13	32	6	0	17	35	2	0	6	102	44	0	8	113	32	0	410	
4:15 PM	13	56	5	0	16	55	1	0	0	111	32	0	8	133	29	0	459	
4:30 PM	10	48	10	0	13	50	3	0	10	126	43	0	14	130	37	0	494	
4:45 PM	11	65	8	0	11	47	7	0	6	114	47	0	14	143	41	0	514	1877
5:00 PM	12	43	5	0	11	50	0	0	8	135	70	0	14	163	53	0	564	2031
5:15 PM	12	49	7	0	19	45	7	0	15	143	69	0	16	147	57	0	586	2158
5:30 PM	13	48	4	0	17	54	4	0	17	141	49	0	13	183	53	0	596	2260
5:45 PM	14	40	7	0	9	47	2	0	10	122	46	0	18	152	51	0	518	2264

Peak 15-Min Flowrates	Northbound				Southbound				Eastbound				Westbound				Total
	Left	Thru	Right	U	Left	Thru	Right	U	Left	Thru	Right	U	Left	Thru	Right	U	
All Vehicles	52	192	16	0	68	216	16	0	68	564	196	0	52	732	212	0	2384
Heavy Trucks	0	0	0	0	0	0	0	0	0	12	8	0	0	12	0	0	32
Buses																	
Pedestrians		12				12				92				12			128
Bicycles	0	8	0		0	0	0		0	0	4		0	0	0		12
Scooters																	

Comments:

LOCATION: Hillsborough St -- Rosemary St
CITY/STATE: Chapel Hill, NC

QC JOB #: 15192522
DATE: Tue, Feb 25 2020

Peak-Hour: 8:00 AM -- 9:00 AM
 Peak 15-Min: 8:45 AM -- 9:00 AM

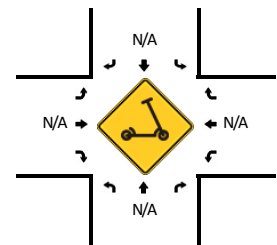
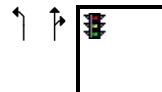
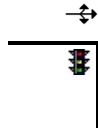
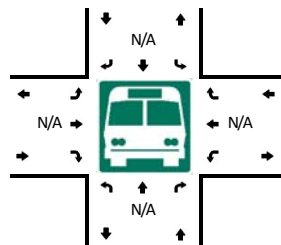
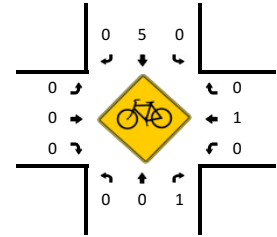
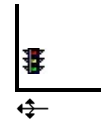
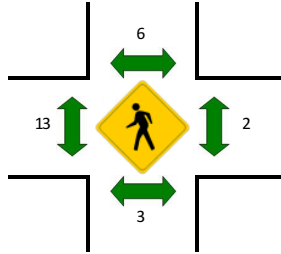
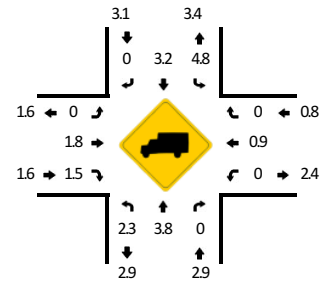
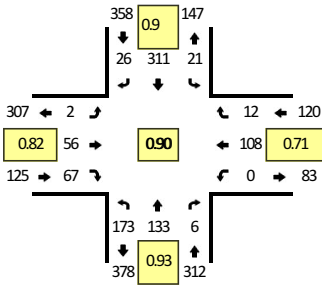

15-Min Count Period Beginning At	Hillsborough St (Northbound)				Hillsborough St (Southbound)				Rosemary St (Eastbound)				Rosemary St (Westbound)				Total	Hourly Totals
	Left	Thru	Right	U	Left	Thru	Right	U	Left	Thru	Right	U	Left	Thru	Right	U		
7:00 AM	19	38	1	0	3	42	4	0	2	7	12	0	0	14	0	0	142	
7:15 AM	18	18	0	0	1	57	4	0	0	11	9	0	0	7	2	0	127	
7:30 AM	33	24	0	0	8	88	6	0	0	6	13	0	1	17	4	0	200	
7:45 AM	40	31	0	0	1	82	5	0	4	18	18	0	0	23	2	0	224	693
8:00 AM	39	33	1	0	5	76	9	0	0	11	20	0	0	20	4	0	218	769
8:15 AM	48	36	0	0	7	80	2	0	0	18	17	0	0	23	3	0	234	876
8:30 AM	38	41	1	0	2	72	6	0	0	11	10	0	0	25	3	0	209	885
8:45 AM	48	23	4	0	7	83	9	0	2	16	20	0	0	40	2	0	254	915

Peak 15-Min Flowrates	Northbound				Southbound				Eastbound				Westbound				Total
	Left	Thru	Right	U	Left	Thru	Right	U	Left	Thru	Right	U	Left	Thru	Right	U	
All Vehicles	192	92	16	0	28	332	36	0	8	64	80	0	0	160	8	0	1016
Heavy Trucks	4	0	0		0	0	0		0	0	0		0	0	0		4
Buses																	
Pedestrians		0				4				20				0			24
Bicycles	0	0	0		0	4	0		0	0	0		0	0	0		4
Scooters																	

Comments:

LOCATION: Hillsborough St -- Rosemary St
CITY/STATE: Chapel Hill, NC

QC JOB #: 15192523
DATE: Tue, Feb 25 2020

Peak-Hour: 11:45 AM -- 12:45 PM
 Peak 15-Min: 12:15 PM -- 12:30 PM

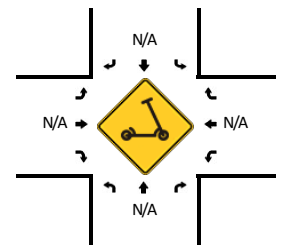
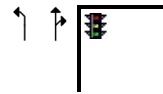
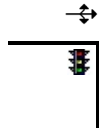
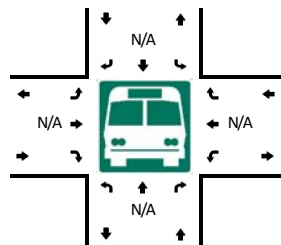
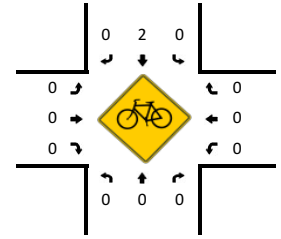
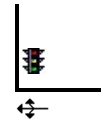
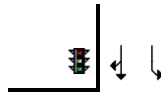
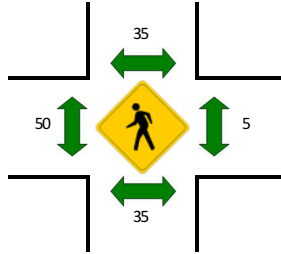
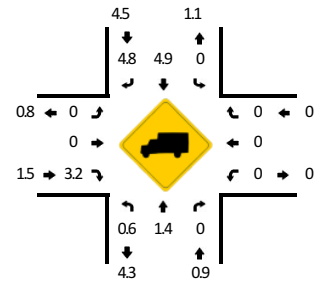
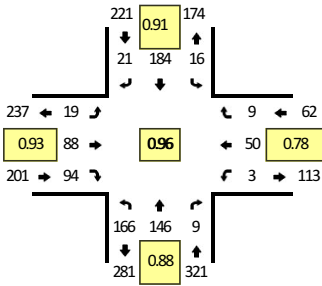

15-Min Count Period Beginning At	Hillsborough St (Northbound)				Hillsborough St (Southbound)				Rosemary St (Eastbound)				Rosemary St (Westbound)				Total	Hourly Totals
	Left	Thru	Right	U	Left	Thru	Right	U	Left	Thru	Right	U	Left	Thru	Right	U		
11:30 AM	28	28	2	0	4	35	2	0	3	15	22	0	0	16	1	0	156	
11:45 AM	38	36	0	0	5	51	4	0	1	19	31	0	1	18	1	0	205	
12:00 PM	44	27	1	0	2	44	8	0	5	27	22	0	1	7	4	0	192	
12:15 PM	41	40	3	0	6	48	7	0	7	21	21	0	1	14	1	0	210	763
12:30 PM	43	43	5	0	3	41	2	0	6	21	20	0	0	11	3	0	198	805
12:45 PM	32	41	2	0	2	40	3	0	0	27	21	0	0	21	6	0	195	795
1:00 PM	36	36	3	0	1	38	2	0	3	28	26	0	1	13	5	0	192	795
1:15 PM	37	40	1	0	3	41	6	0	4	23	21	0	3	16	3	0	198	783

Peak 15-Min Flowrates	Northbound				Southbound				Eastbound				Westbound				Total
	Left	Thru	Right	U	Left	Thru	Right	U	Left	Thru	Right	U	Left	Thru	Right	U	
All Vehicles	164	160	12	0	24	192	28	0	28	84	84	0	4	56	4	0	840
Heavy Trucks	0	4	0		0	8	4		0	0	4		0	0	0		20
Buses																	
Pedestrians		44				40				60				4			148
Bicycles	0	0	0		0	8	0		0	0	0		0	0	0		8
Scoters																	

Comments:

LOCATION: Hillsborough St -- Rosemary St
CITY/STATE: Chapel Hill, NC

QC JOB #: 15192524
DATE: Wed, Feb 19 2020

Peak-Hour: 5:00 PM -- 6:00 PM
Peak 15-Min: 5:15 PM -- 5:30 PM

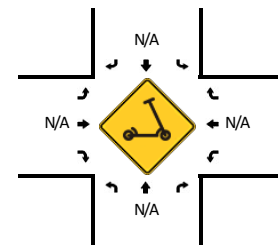
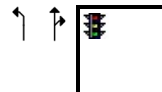
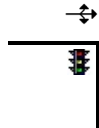
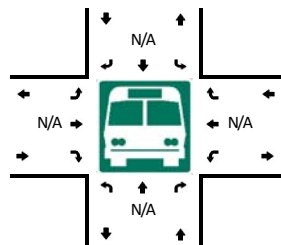
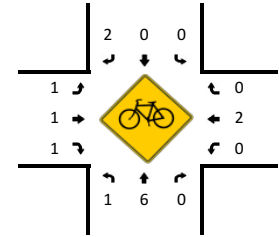
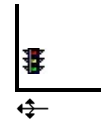
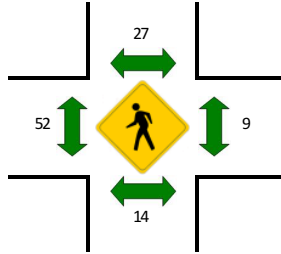
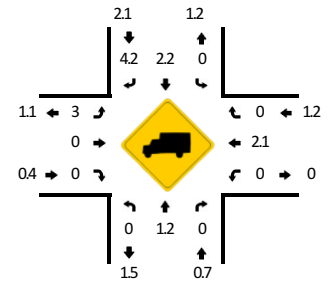
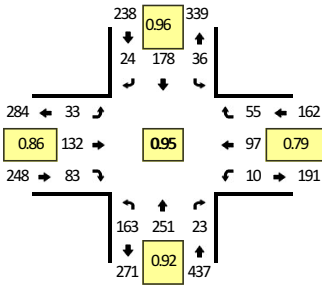

15-Min Count Period Beginning At	Hillsborough St (Northbound)				Hillsborough St (Southbound)				Rosemary St (Eastbound)				Rosemary St (Westbound)				Total	Hourly Totals
	Left	Thru	Right	U	Left	Thru	Right	U	Left	Thru	Right	U	Left	Thru	Right	U		
4:00 PM	21	48	1	0	2	34	1	0	8	28	27	0	0	9	5	0	184	
4:15 PM	23	54	0	0	5	38	2	0	6	24	25	0	1	11	8	0	197	
4:30 PM	36	62	2	0	8	48	2	0	4	36	23	0	0	21	9	0	251	
4:45 PM	39	68	4	0	7	26	4	0	8	35	30	0	1	17	16	0	255	887
5:00 PM	32	65	8	0	8	45	5	0	5	39	18	0	2	19	9	0	255	958
5:15 PM	41	67	7	0	5	50	2	0	8	40	24	0	2	22	18	0	286	1047
5:30 PM	53	62	4	0	9	45	7	0	12	18	26	0	1	23	15	0	275	1071
5:45 PM	37	57	4	0	14	38	10	0	8	35	15	0	5	33	13	0	269	1085
Peak 15-Min Flowrates	Northbound				Southbound				Eastbound				Westbound				Total	
	Left	Thru	Right	U	Left	Thru	Right	U	Left	Thru	Right	U	Left	Thru	Right	U		
All Vehicles	164	268	28	0	20	200	8	0	32	160	96	0	8	88	72	0	1144	
Heavy Trucks	0	0	0		0	4	0		0	0	0		0	8	0		12	
Buses																		
Pedestrians		0				12				8				0			20	
Bicycles	0	12	0		0	0	4		4	0	0		0	0	0		20	
Scoters																		

Comments:

LOCATION: Pittsboro St -- Cameron Ave
CITY/STATE: Chapel Hill, NC

QC JOB #: 15192525
DATE: Tue, Feb 25 2020

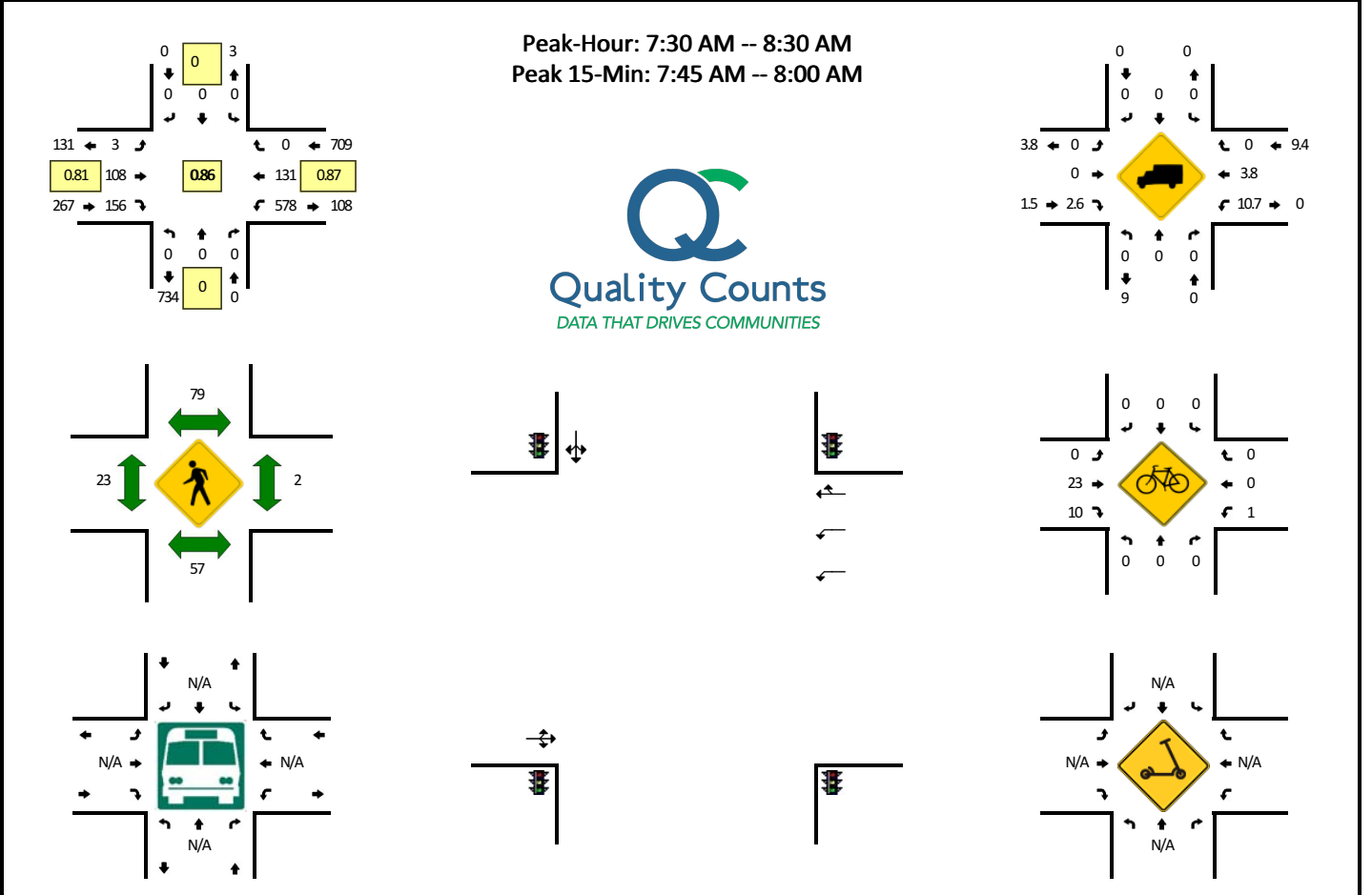

15-Min Count Period Beginning At	Pittsboro St (Northbound)				Pittsboro St (Southbound)				Cameron Ave (Eastbound)				Cameron Ave (Westbound)				Total	Hourly Totals
	Left	Thru	Right	U	Left	Thru	Right	U	Left	Thru	Right	U	Left	Thru	Right	U		
7:00 AM	0	0	0	0	0	0	0	0	0	11	21	0	82	43	0	0	157	
7:15 AM	0	0	0	0	0	0	0	0	0	17	26	0	116	27	0	0	186	
7:30 AM	0	0	0	0	0	0	0	0	0	28	43	0	141	24	0	0	236	
7:45 AM	0	0	0	0	0	0	0	0	1	30	51	0	167	36	0	0	285	864
8:00 AM	0	0	0	0	0	0	0	0	1	28	35	0	132	37	0	0	233	940
8:15 AM	0	0	0	0	0	0	0	0	1	22	27	0	138	34	0	0	222	976
8:30 AM	0	0	0	0	1	0	0	0	1	27	33	0	126	35	1	0	224	964
8:45 AM	0	0	0	0	0	0	0	0	0	17	44	0	131	39	0	0	231	910
Peak 15-Min Flowrates	Northbound				Southbound				Eastbound				Westbound				Total	
	Left	Thru	Right	U	Left	Thru	Right	U	Left	Thru	Right	U	Left	Thru	Right	U		
All Vehicles	0	0	0	0	0	0	0	0	4	120	204	0	668	144	0	0	1140	
Heavy Trucks	0	0	0	0	0	0	0	0	0	0	4	0	76	8	0	0	88	
Buses																		
Pedestrians		72				176				48				4			300	
Bicycles	0	0	0		0	0	0		0	12	12		0	0	0		24	
Scoters																		

Comments:

LOCATION: Columbia St -- Cameron Ave
CITY/STATE: Chapel Hill, NC

QC JOB #: 15192528
DATE: Tue, Feb 25 2020

Peak-Hour: 7:30 AM -- 8:30 AM
Peak 15-Min: 7:45 AM -- 8:00 AM

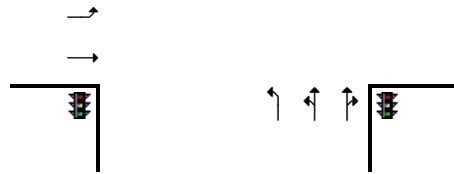
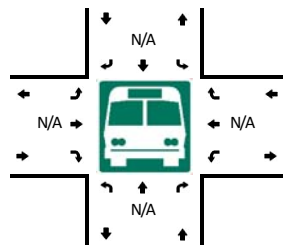
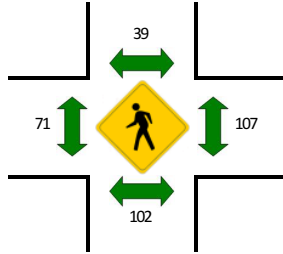
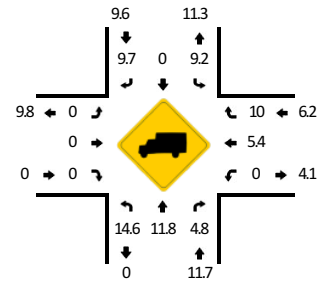
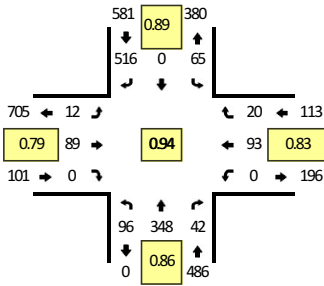

15-Min Count Period Beginning At	Columbia St (Northbound)				Columbia St (Southbound)				Cameron Ave (Eastbound)				Cameron Ave (Westbound)				Total	Hourly Totals
	Left	Thru	Right	U	Left	Thru	Right	U	Left	Thru	Right	U	Left	Thru	Right	U		
7:00 AM	32	70	4	0	5	0	80	0	0	10	0	0	0	22	4	0	227	
7:15 AM	21	76	5	0	2	0	99	0	1	18	0	0	0	13	3	0	238	
7:30 AM	19	92	9	0	13	0	143	0	3	19	0	0	0	11	7	0	316	
7:45 AM	26	75	13	0	22	0	142	0	2	30	0	0	0	28	3	0	341	1122
8:00 AM	26	80	4	0	15	0	120	0	4	20	0	0	0	30	4	0	303	1198
8:15 AM	25	101	16	0	15	0	111	0	3	20	0	0	0	24	6	0	321	1281
8:30 AM	25	72	7	0	15	0	117	0	8	25	0	0	0	29	9	0	307	1272
8:45 AM	27	98	8	0	12	0	105	0	3	11	0	0	0	27	7	0	298	1229
Peak 15-Min Flowrates	Northbound				Southbound				Eastbound				Westbound				Total	
	Left	Thru	Right	U	Left	Thru	Right	U	Left	Thru	Right	U	Left	Thru	Right	U		
All Vehicles	104	300	52	0	88	0	568	0	8	120	0	0	0	112	12	0	1364	
Heavy Trucks	16	44	4		4	0	48		0	0	0		0	12	0		128	
Buses		260				80				180				184			704	
Pedestrians	0	4	0		8	0	0		0	0	0		0	0	0		12	
Bicycles																		
Scoters																		

Comments:

LOCATION: Columbia St -- Cameron Ave
CITY/STATE: Chapel Hill, NC

QC JOB #: 15192529
DATE: Tue, Feb 25 2020

Peak-Hour: 11:45 AM -- 12:45 PM
Peak 15-Min: 12:30 PM -- 12:45 PM

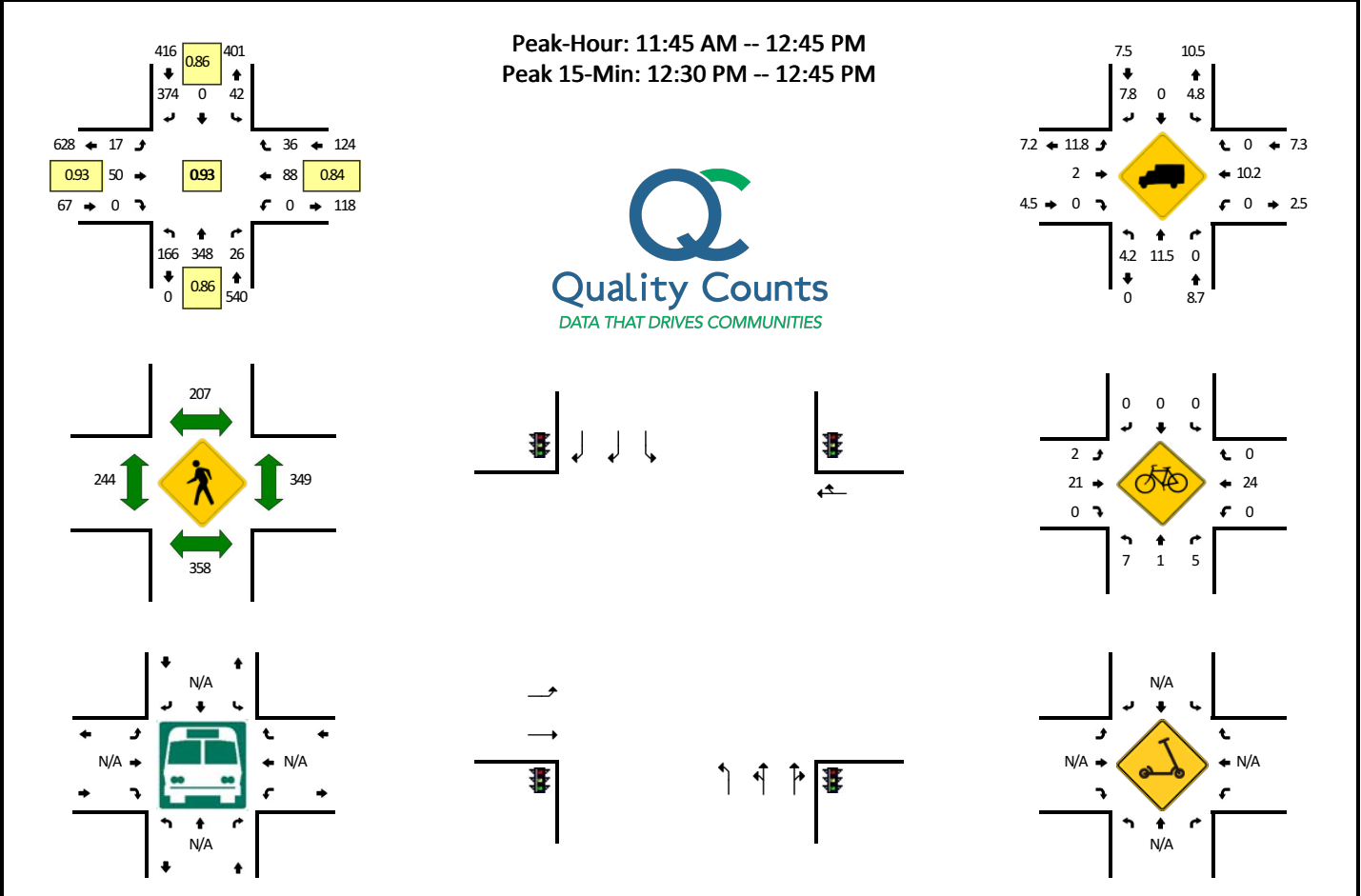

15-Min Count Period Beginning At	Columbia St (Northbound)				Columbia St (Southbound)				Cameron Ave (Eastbound)				Cameron Ave (Westbound)				Total	Hourly Totals
	Left	Thru	Right	U	Left	Thru	Right	U	Left	Thru	Right	U	Left	Thru	Right	U		
11:30 AM	39	98	9	0	8	0	57	0	1	12	0	0	0	21	7	0	252	
11:45 AM	42	74	4	0	7	0	90	0	4	12	0	0	0	23	9	0	265	
12:00 PM	31	89	7	0	9	0	93	0	7	10	0	0	0	18	4	0	268	
12:15 PM	47	81	8	0	16	0	105	0	4	12	0	0	0	20	13	0	306	1091
12:30 PM	46	104	7	0	10	0	86	0	2	16	0	0	0	27	10	0	308	1147
12:45 PM	26	83	7	0	12	0	85	0	6	16	0	0	0	19	6	0	260	1142
1:00 PM	22	86	4	0	9	0	80	0	2	11	0	0	0	23	7	0	244	1118
1:15 PM	29	75	12	0	7	0	109	0	5	13	0	0	0	15	8	0	273	1085
Peak 15-Min Flowrates	Northbound				Southbound				Eastbound				Westbound				Total	
	Left	Thru	Right	U	Left	Thru	Right	U	Left	Thru	Right	U	Left	Thru	Right	U		
All Vehicles	184	416	28	0	40	0	344	0	8	64	0	0	0	108	40	0	1232	
Heavy Trucks	4	48	0		4	0	32		0	0	0		0	12	0		100	
Buses																		
Pedestrians		148				112				96				160			516	
Bicycles	0	4	8		0	0	0		4	24	0		0	20	0		60	
Scoters																		

Comments:

LOCATION: Columbia St -- Cameron Ave
CITY/STATE: Chapel Hill, NC

QC JOB #: 15192530
DATE: Wed, Feb 19 2020

Peak-Hour: 5:00 PM -- 6:00 PM
Peak 15-Min: 5:30 PM -- 5:45 PM

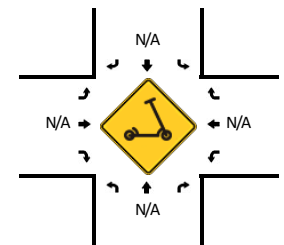
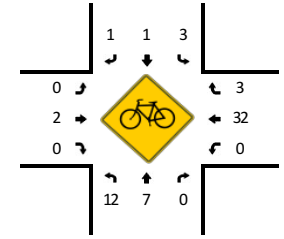
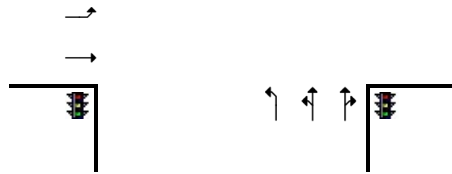
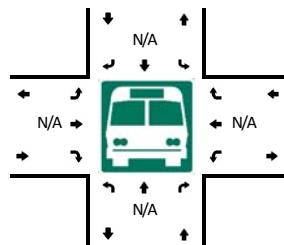
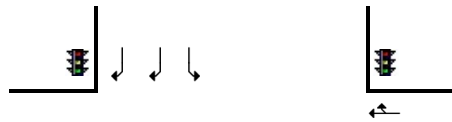
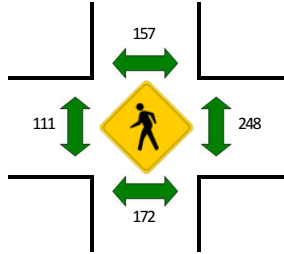
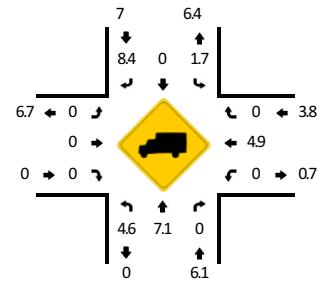
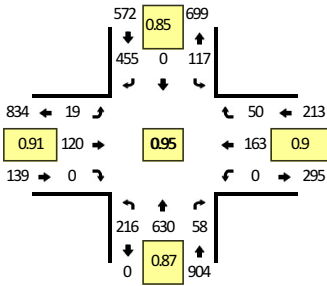

15-Min Count Period Beginning At	Columbia St (Northbound)				Columbia St (Southbound)				Cameron Ave (Eastbound)				Cameron Ave (Westbound)				Total	Hourly Totals
	Left	Thru	Right	U	Left	Thru	Right	U	Left	Thru	Right	U	Left	Thru	Right	U		
4:00 PM	37	129	7	0	13	0	78	0	4	14	0	0	0	42	10	0	334	
4:15 PM	31	141	5	0	8	0	77	0	5	15	0	0	0	31	13	0	326	
4:30 PM	31	129	7	0	18	0	100	0	4	20	0	0	0	35	20	0	364	
4:45 PM	44	132	8	0	21	0	113	0	4	25	0	0	0	27	5	0	379	1403
5:00 PM	62	159	17	0	30	0	98	0	6	32	0	0	0	43	8	0	455	1524
5:15 PM	34	142	22	0	26	0	142	0	0	30	0	0	0	41	18	0	455	1653
5:30 PM	66	186	8	0	29	0	106	0	9	26	0	0	0	40	9	0	479	1768
5:45 PM	54	143	11	0	32	0	109	0	4	32	0	0	0	39	15	0	439	1828
Peak 15-Min Flowrates	Northbound				Southbound				Eastbound				Westbound				Total	
	Left	Thru	Right	U	Left	Thru	Right	U	Left	Thru	Right	U	Left	Thru	Right	U		
All Vehicles	264	744	32	0	116	0	424	0	36	104	0	0	0	160	36	0	1916	
Heavy Trucks	12	40	0		4	0	48		0	0	0		0	12	0		116	
Buses																		
Pedestrians		132				136				80				224			572	
Bicycles	16	4	0		4	0	4		0	8	0		0	24	0		60	
Scoters																		

Comments:

LOCATION: Raleigh St -- Cameron Ave/Country Club Rd
CITY/STATE: Chapel Hill, NC

QC JOB #: 15192531
DATE: Tue, Feb 25 2020

Peak-Hour: 8:00 AM -- 9:00 AM
 Peak 15-Min: 8:45 AM -- 9:00 AM

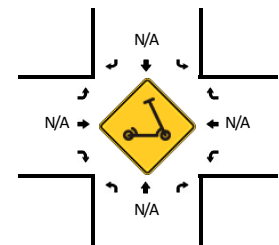
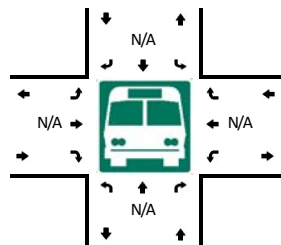
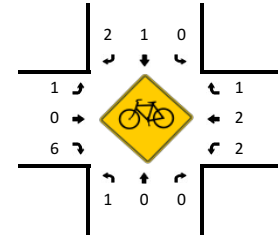
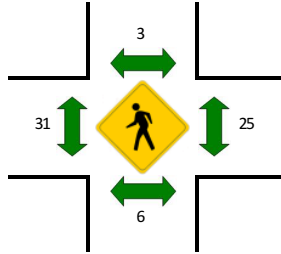
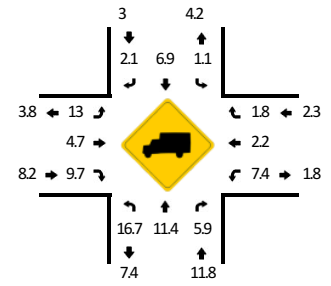
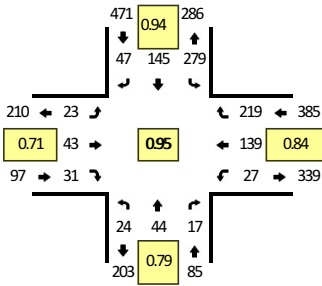

15-Min Count Period Beginning At	Raleigh St (Northbound)				Raleigh St (Southbound)				Cameron Ave/Country Club Rd (Eastbound)				Cameron Ave/Country Club Rd (Westbound)				Total	Hourly Totals
	Left	Thru	Right	U	Left	Thru	Right	U	Left	Thru	Right	U	Left	Thru	Right	U		
7:00 AM	5	19	5	0	31	23	2	0	3	13	6	0	3	9	29	0	148	
7:15 AM	1	8	4	0	53	26	6	0	4	7	3	0	4	12	24	0	152	
7:30 AM	4	8	6	0	73	38	5	0	2	17	5	0	8	23	37	0	226	
7:45 AM	6	11	4	0	63	44	18	0	7	20	7	0	10	29	49	0	268	794
8:00 AM	8	11	5	0	73	40	12	0	5	12	9	0	7	30	42	0	254	900
8:15 AM	7	11	1	0	68	31	11	0	7	6	7	0	7	29	62	0	247	995
8:30 AM	3	9	3	0	75	36	10	0	6	20	8	0	6	36	51	0	263	1032
8:45 AM	6	13	8	0	63	38	14	0	5	5	7	0	7	44	64	0	274	1038

Peak 15-Min Flowrates	Northbound				Southbound				Eastbound				Westbound				Total
	Left	Thru	Right	U	Left	Thru	Right	U	Left	Thru	Right	U	Left	Thru	Right	U	
All Vehicles	24	52	32	0	252	152	56	0	20	20	28	0	28	176	256	0	1096
Heavy Trucks	4	0	4		0	12	0		0	0	4		0	0	4		28
Buses																	
Pedestrians		4				8				48				36			96
Bicycles	0	0	0		0	0	4		4	0	4		0	0	0		12
Scooters																	

Comments:

LOCATION: Raleigh St -- Cameron Ave/Country Club Rd
CITY/STATE: Chapel Hill, NC

QC JOB #: 15192532
DATE: Tue, Feb 25 2020

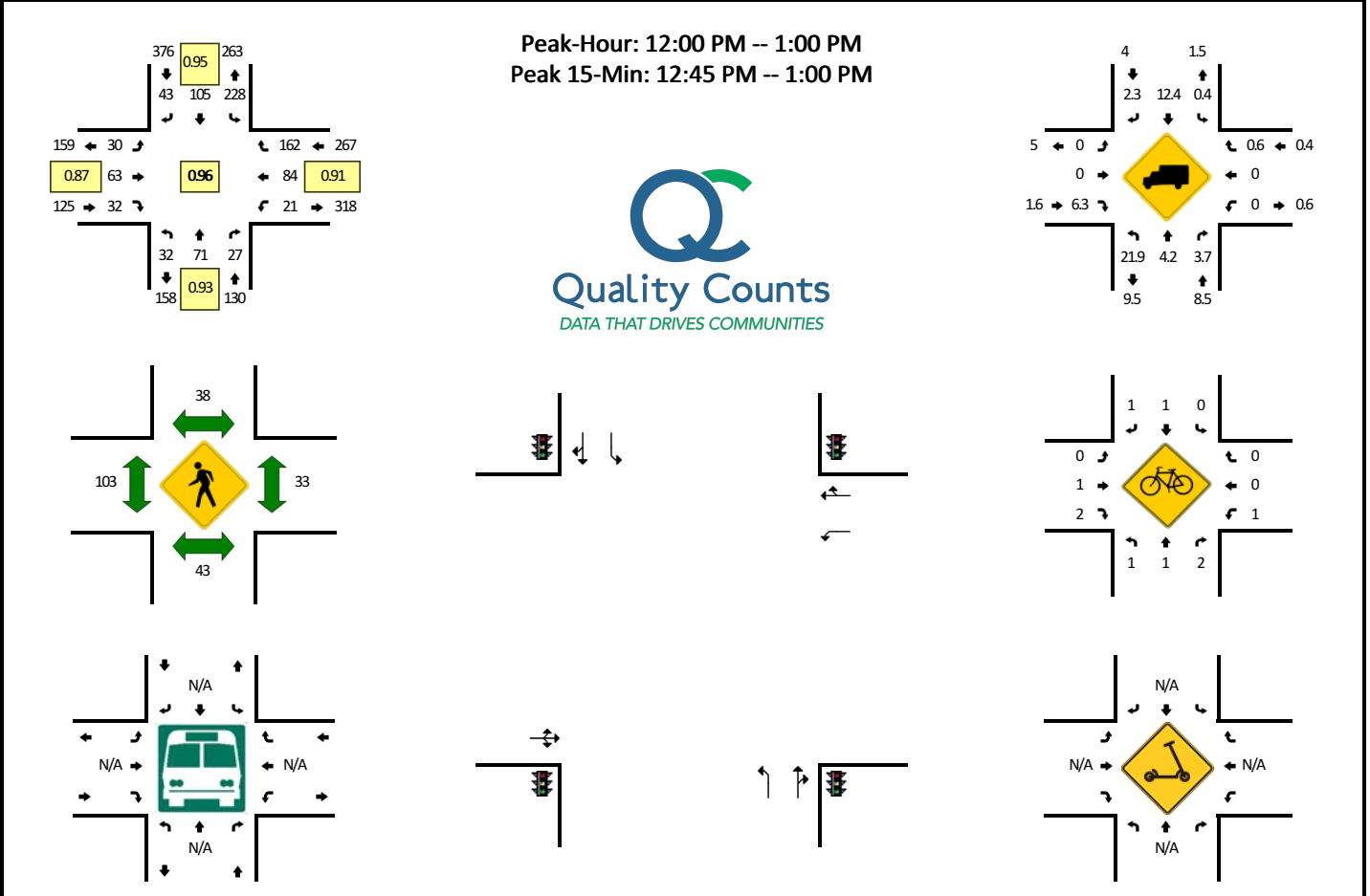

15-Min Count Period Beginning At	Raleigh St (Northbound)				Raleigh St (Southbound)				Cameron Ave/Country Club Rd (Eastbound)				Cameron Ave/Country Club Rd (Westbound)				Total	Hourly Totals
	Left	Thru	Right	U	Left	Thru	Right	U	Left	Thru	Right	U	Left	Thru	Right	U		
11:30 AM	15	18	5	0	41	21	6	0	4	13	5	0	4	18	37	0	187	
11:45 AM	9	6	8	0	60	26	6	0	2	12	4	0	5	19	46	0	203	
12:00 PM	10	15	6	0	58	30	11	0	5	13	7	0	5	25	43	0	228	
12:15 PM	8	16	7	0	57	24	11	0	13	14	7	0	7	22	33	0	219	837
12:30 PM	7	20	6	0	61	17	10	0	8	16	12	0	6	17	37	0	217	867
12:45 PM	7	20	8	0	52	34	11	0	4	20	6	0	3	20	49	0	234	898
1:00 PM	4	16	5	0	51	26	10	0	1	16	7	0	3	17	45	0	201	871
1:15 PM	10	14	10	0	44	25	4	0	2	18	4	0	4	15	36	0	186	838
Peak 15-Min Flowrates	Northbound				Southbound				Eastbound				Westbound				Total	
	Left	Thru	Right	U	Left	Thru	Right	U	Left	Thru	Right	U	Left	Thru	Right	U		
All Vehicles	28	80	32	0	208	136	44	0	16	80	24	0	12	80	196	0	936	
Heavy Trucks	4	4	4		0	16	4		0	0	0		0	0	4		36	
Buses																		
Pedestrians		8				44				92				32			176	
Bicycles	0	0	4		0	0	0		0	0	4		4	0	0		12	
Scoters																		

Comments:

LOCATION: Raleigh St -- Cameron Ave/Country Club Rd
CITY/STATE: Chapel Hill, NC

QC JOB #: 15192533
DATE: Wed, Feb 19 2020

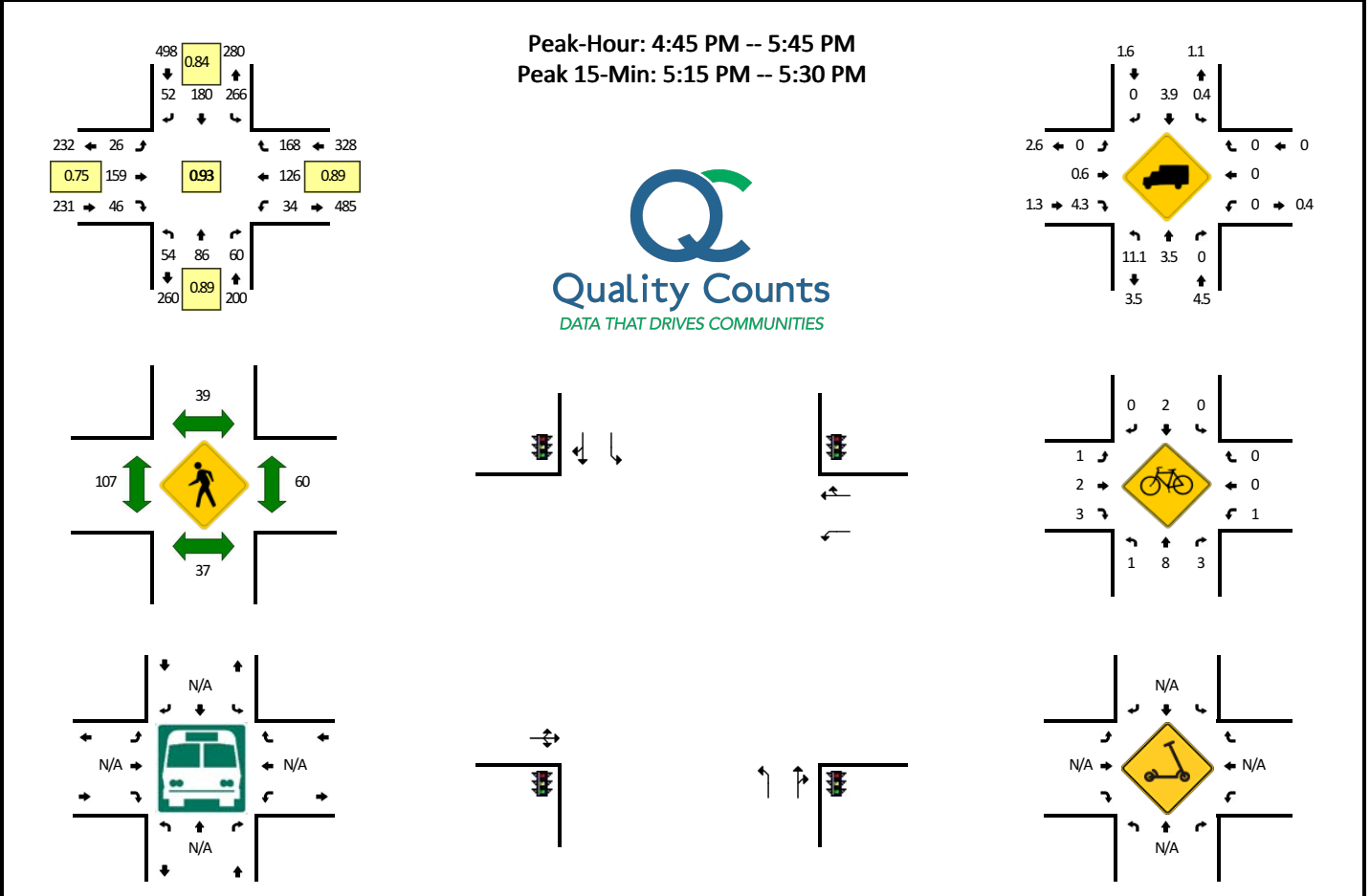

15-Min Count Period Beginning At	Raleigh St (Northbound)				Raleigh St (Southbound)				Cameron Ave/Country Club Rd (Eastbound)				Cameron Ave/Country Club Rd (Westbound)				Total	Hourly Totals
	Left	Thru	Right	U	Left	Thru	Right	U	Left	Thru	Right	U	Left	Thru	Right	U		
4:00 PM	19	19	14	0	62	24	8	0	2	29	11	0	4	24	39	0	255	
4:15 PM	12	23	12	0	59	22	7	0	3	24	5	0	6	31	48	0	252	
4:30 PM	14	23	14	0	63	32	9	0	7	22	5	0	6	24	41	0	260	
4:45 PM	13	18	13	0	61	42	13	0	8	29	6	0	7	27	47	0	284	1051
5:00 PM	12	23	16	0	61	47	12	0	8	46	23	0	6	30	37	0	321	1117
5:15 PM	11	17	21	0	84	49	15	0	6	45	8	0	14	27	41	0	338	1203
5:30 PM	18	28	10	0	60	42	12	0	4	39	9	0	7	42	43	0	314	1257
5:45 PM	15	12	17	0	46	50	15	0	9	27	5	0	9	26	47	0	278	1251
Peak 15-Min Flowrates	Northbound				Southbound				Eastbound				Westbound				Total	
	Left	Thru	Right	U	Left	Thru	Right	U	Left	Thru	Right	U	Left	Thru	Right	U		
All Vehicles	44	68	84	0	336	196	60	0	24	180	32	0	56	108	164	0	1352	
Heavy Trucks	8	4	0		0	8	0		0	0	0		0	0	0		20	
Buses																		
Pedestrians		24				40				84				44			192	
Bicycles	4	16	0		0	4	0		0	4	0		0	0	0		28	
Scoters																		

Comments:

LOCATION: Western Parking Deck -- Rosemary St
CITY/STATE: Chapel Hill, NC

QC JOB #: 15192534
DATE: Tue, Feb 25 2020

Peak-Hour: 8:00 AM -- 9:00 AM
 Peak 15-Min: 8:45 AM -- 9:00 AM

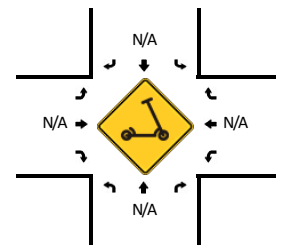
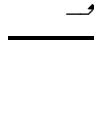
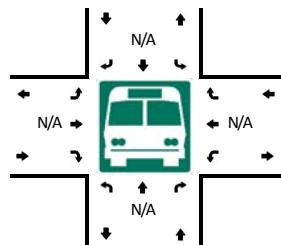
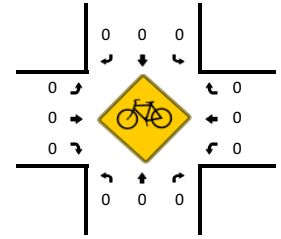
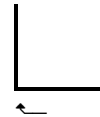
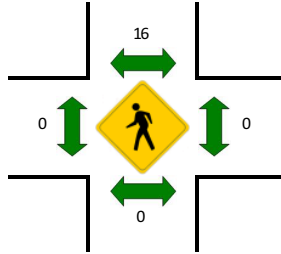
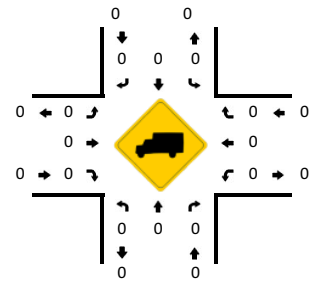
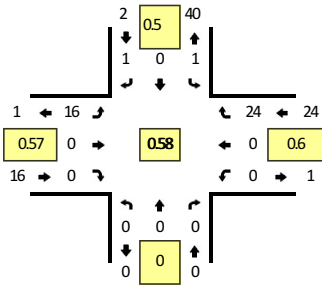

15-Min Count Period Beginning At	Western Parking Deck (Northbound)				Western Parking Deck (Southbound)				Rosemary St (Eastbound)				Rosemary St (Westbound)				Total	Hourly Totals
	Left	Thru	Right	U	Left	Thru	Right	U	Left	Thru	Right	U	Left	Thru	Right	U		
7:00 AM	0	0	0	0	0	0	0	0	0	0	0	0	0	0	0	0	0	
7:15 AM	0	0	0	0	0	0	0	0	2	0	0	0	0	0	1	0	3	
7:30 AM	0	0	0	0	1	0	1	0	2	0	0	0	0	0	2	0	6	
7:45 AM	0	0	0	0	0	0	0	0	2	0	0	0	0	0	5	0	7	16
8:00 AM	0	0	0	0	0	0	0	0	3	0	0	0	0	0	3	0	6	22
8:15 AM	0	0	0	0	1	0	0	0	4	0	0	0	0	0	5	0	10	29
8:30 AM	0	0	0	0	0	0	0	0	2	0	0	0	0	0	6	0	8	31
8:45 AM	0	0	0	0	0	0	1	0	7	0	0	0	0	0	10	0	18	42

Peak 15-Min Flowrates	Northbound				Southbound				Eastbound				Westbound				Total
	Left	Thru	Right	U	Left	Thru	Right	U	Left	Thru	Right	U	Left	Thru	Right	U	
All Vehicles	0	0	0	0	0	0	4	0	28	0	0	0	0	0	40	0	72
Heavy Trucks	0	0	0	0	0	0	0	0	0	0	0	0	0	0	0	0	0
Buses																	
Pedestrians		0				12				0				0			12
Bicycles	0	0	0		0	0	0		0	0	0		0	0	0		0
Scooters																	0

Comments:

LOCATION: Western Parking Deck -- Rosemary St
CITY/STATE: Chapel Hill, NC

QC JOB #: 15192535
DATE: Tue, Feb 25 2020

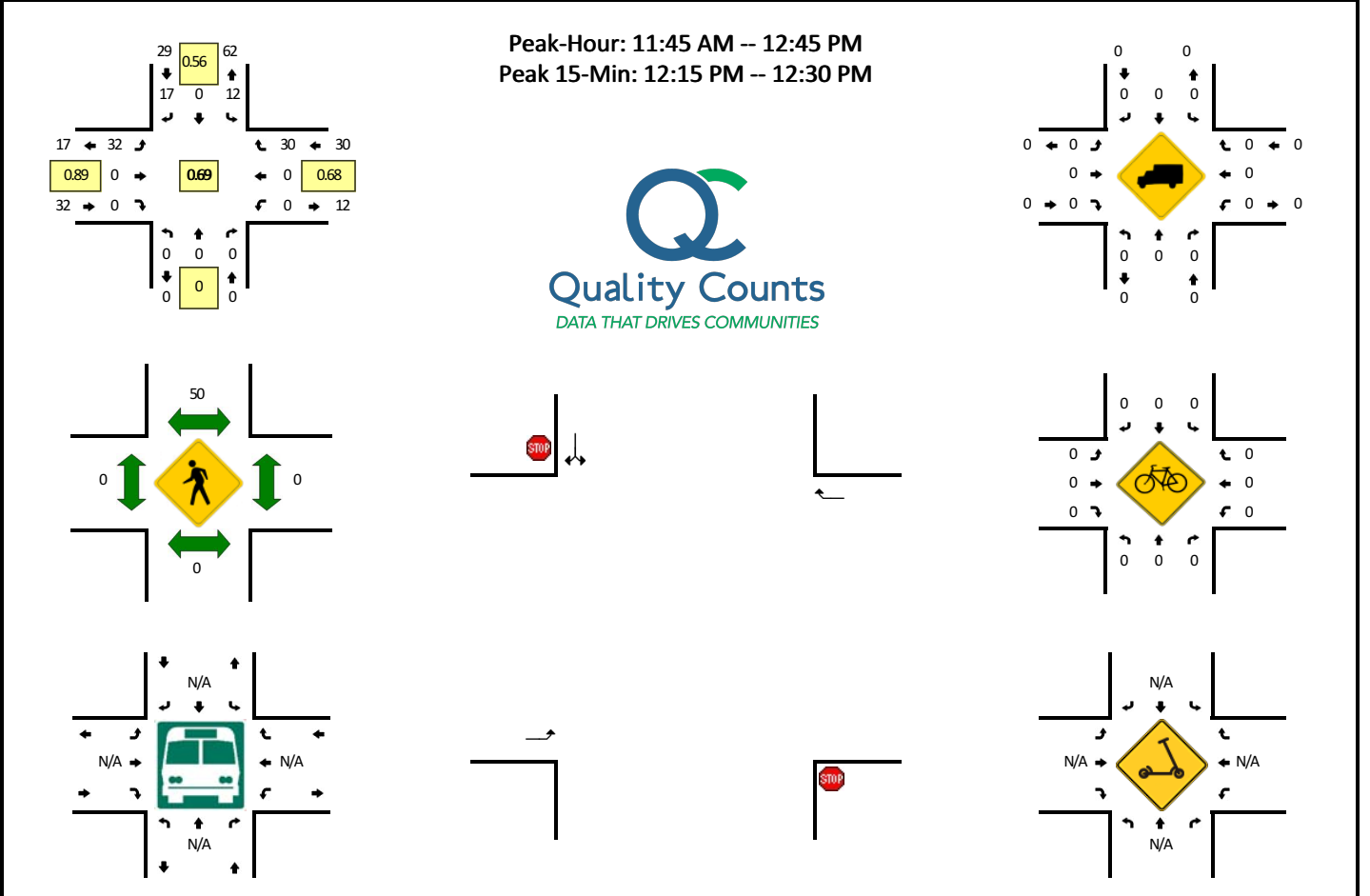

15-Min Count Period Beginning At	Western Parking Deck (Northbound)				Western Parking Deck (Southbound)				Rosemary St (Eastbound)				Rosemary St (Westbound)				Total	Hourly Totals
	Left	Thru	Right	U	Left	Thru	Right	U	Left	Thru	Right	U	Left	Thru	Right	U		
11:30 AM	0	0	0	0	1	0	2	0	6	0	0	0	0	0	7	0	16	
11:45 AM	0	0	0	0	3	0	2	0	9	0	0	0	0	0	6	0	20	
12:00 PM	0	0	0	0	2	0	1	0	8	0	0	0	0	0	7	0	18	
12:15 PM	0	0	0	0	5	0	8	0	9	0	0	0	0	0	11	0	33	87
12:30 PM	0	0	0	0	2	0	6	0	6	0	0	0	0	0	6	0	20	91
12:45 PM	0	0	0	0	0	0	4	0	5	0	0	0	0	0	6	0	15	86
1:00 PM	0	0	0	0	3	0	5	0	4	0	0	0	0	0	8	0	20	88
1:15 PM	0	0	0	0	1	0	5	0	1	0	0	0	0	0	5	0	12	67
Peak 15-Min Flowrates	Northbound				Southbound				Eastbound				Westbound				Total	
	Left	Thru	Right	U	Left	Thru	Right	U	Left	Thru	Right	U	Left	Thru	Right	U		
All Vehicles	0	0	0	0	20	0	32	0	36	0	0	0	0	0	44	0	132	
Heavy Trucks	0	0	0	0	0	0	0	0	0	0	0	0	0	0	0	0	0	
Buses																		
Pedestrians		0				52				0				0			52	
Bicycles	0	0	0		0	0	0		0	0	0		0	0	0		0	
Scoters																		

Comments:

LOCATION: Western Parking Deck -- Rosemary St
CITY/STATE: Chapel Hill, NC

QC JOB #: 15192536
DATE: Wed, Feb 19 2020

Peak-Hour: 4:45 PM -- 5:45 PM
 Peak 15-Min: 5:00 PM -- 5:15 PM

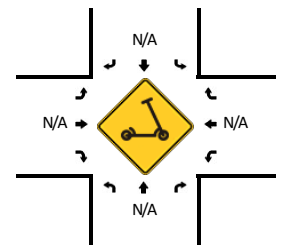
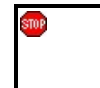
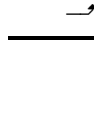
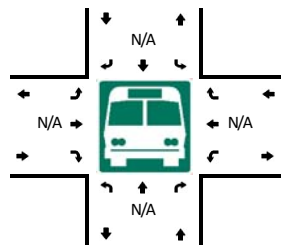
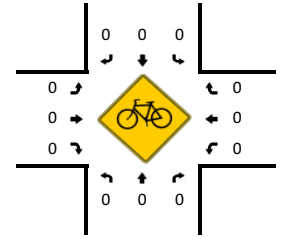
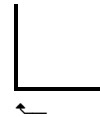
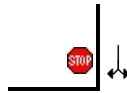
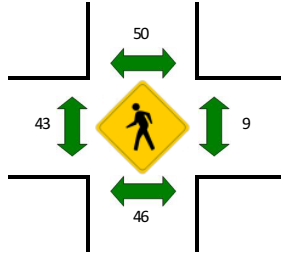
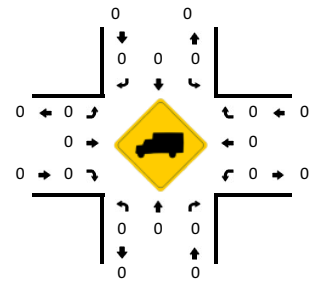
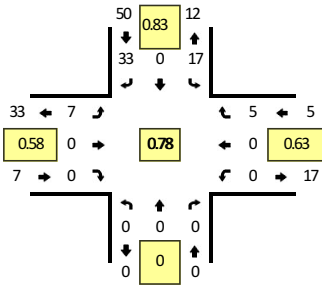

15-Min Count Period Beginning At	Western Parking Deck (Northbound)				Western Parking Deck (Southbound)				Rosemary St (Eastbound)				Rosemary St (Westbound)				Total	Hourly Totals
	Left	Thru	Right	U	Left	Thru	Right	U	Left	Thru	Right	U	Left	Thru	Right	U		
4:00 PM	0	0	0	0	2	0	8	0	0	0	0	0	0	0	1	0	11	
4:15 PM	0	0	0	0	1	0	6	0	1	0	0	0	0	0	0	0	8	
4:30 PM	0	0	0	0	5	0	5	0	0	0	0	0	0	0	0	0	10	
4:45 PM	0	0	0	0	4	0	5	0	1	0	0	0	0	0	1	0	11	40
5:00 PM	0	0	0	0	7	0	8	0	3	0	0	0	0	0	2	0	20	49
5:15 PM	0	0	0	0	3	0	12	0	2	0	0	0	0	0	1	0	18	59
5:30 PM	0	0	0	0	3	0	8	0	1	0	0	0	0	0	1	0	13	62
5:45 PM	0	0	0	0	4	0	2	0	1	0	0	0	0	0	0	0	7	58
Peak 15-Min Flowrates	Northbound				Southbound				Eastbound				Westbound				Total	
	Left	Thru	Right	U	Left	Thru	Right	U	Left	Thru	Right	U	Left	Thru	Right	U		
All Vehicles	0	0	0	0	28	0	32	0	12	0	0	0	0	0	8	0	80	
Heavy Trucks	0	0	0	0	0	0	0	0	0	0	0	0	0	0	0	0	0	
Buses																		
Pedestrians		36				60				60				4			160	
Bicycles	0	0	0		0	0	0		0	0	0		0	0	0		0	
Scoters																		

Comments:

LOCATION: Surface Lot -- Rosemary St
CITY/STATE: Chapel Hill, NC

QC JOB #: 15192537
DATE: Tue, Feb 25 2020

Peak-Hour: 7:30 AM -- 8:30 AM
 Peak 15-Min: 8:15 AM -- 8:30 AM

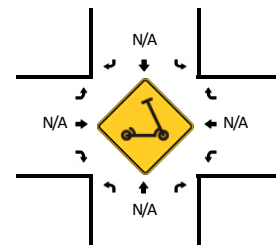
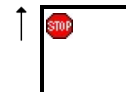
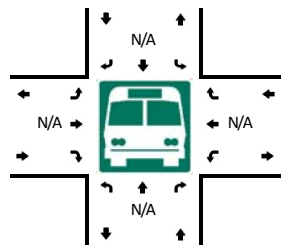
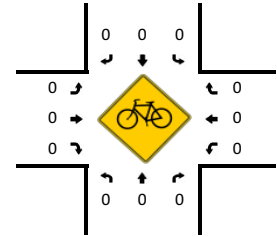
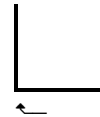
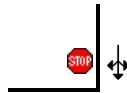
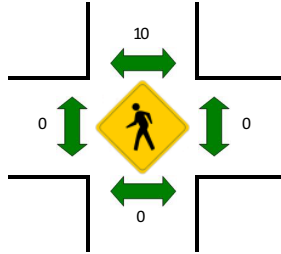
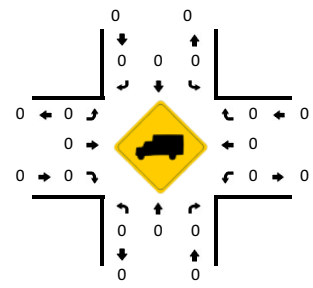
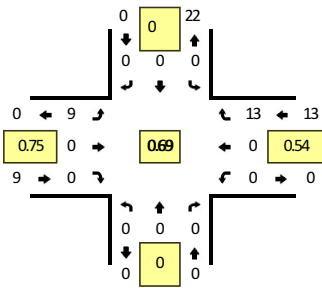

15-Min Count Period Beginning At	Surface Lot (Northbound)				Surface Lot (Southbound)				Rosemary St (Eastbound)				Rosemary St (Westbound)				Total	Hourly Totals
	Left	Thru	Right	U	Left	Thru	Right	U	Left	Thru	Right	U	Left	Thru	Right	U		
7:00 AM	0	0	0	0	0	0	0	0	0	0	0	0	0	0	0	0	0	
7:15 AM	0	0	0	0	0	0	0	0	2	0	0	0	0	0	0	0	2	
7:30 AM	0	0	0	0	0	0	0	0	2	0	0	0	0	0	3	0	5	
7:45 AM	0	0	0	0	0	0	0	0	2	0	0	0	0	0	2	0	4	11
8:00 AM	0	0	0	0	0	0	0	0	3	0	0	0	0	0	2	0	5	16
8:15 AM	0	0	0	0	0	0	0	0	2	0	0	0	0	0	6	0	8	22
8:30 AM	0	0	0	0	0	0	0	0	2	0	0	0	0	0	1	0	3	20
8:45 AM	0	0	0	0	0	0	0	0	0	0	0	0	0	0	2	0	2	18
Peak 15-Min Flowrates	Northbound				Southbound				Eastbound				Westbound				Total	
	Left	Thru	Right	U	Left	Thru	Right	U	Left	Thru	Right	U	Left	Thru	Right	U		
All Vehicles	0	0	0	0	0	0	0	0	8	0	0	0	0	0	24	0	32	
Heavy Trucks	0	0	0	0	0	0	0	0	0	0	0	0	0	0	0	0	0	
Buses																		
Pedestrians		0				24				0				0			24	
Bicycles	0	0	0		0	0	0		0	0	0		0	0	0		0	
Scoters																		

Comments:

LOCATION: Surface Lot -- Rosemary St
CITY/STATE: Chapel Hill, NC

QC JOB #: 15192538
DATE: Tue, Feb 25 2020

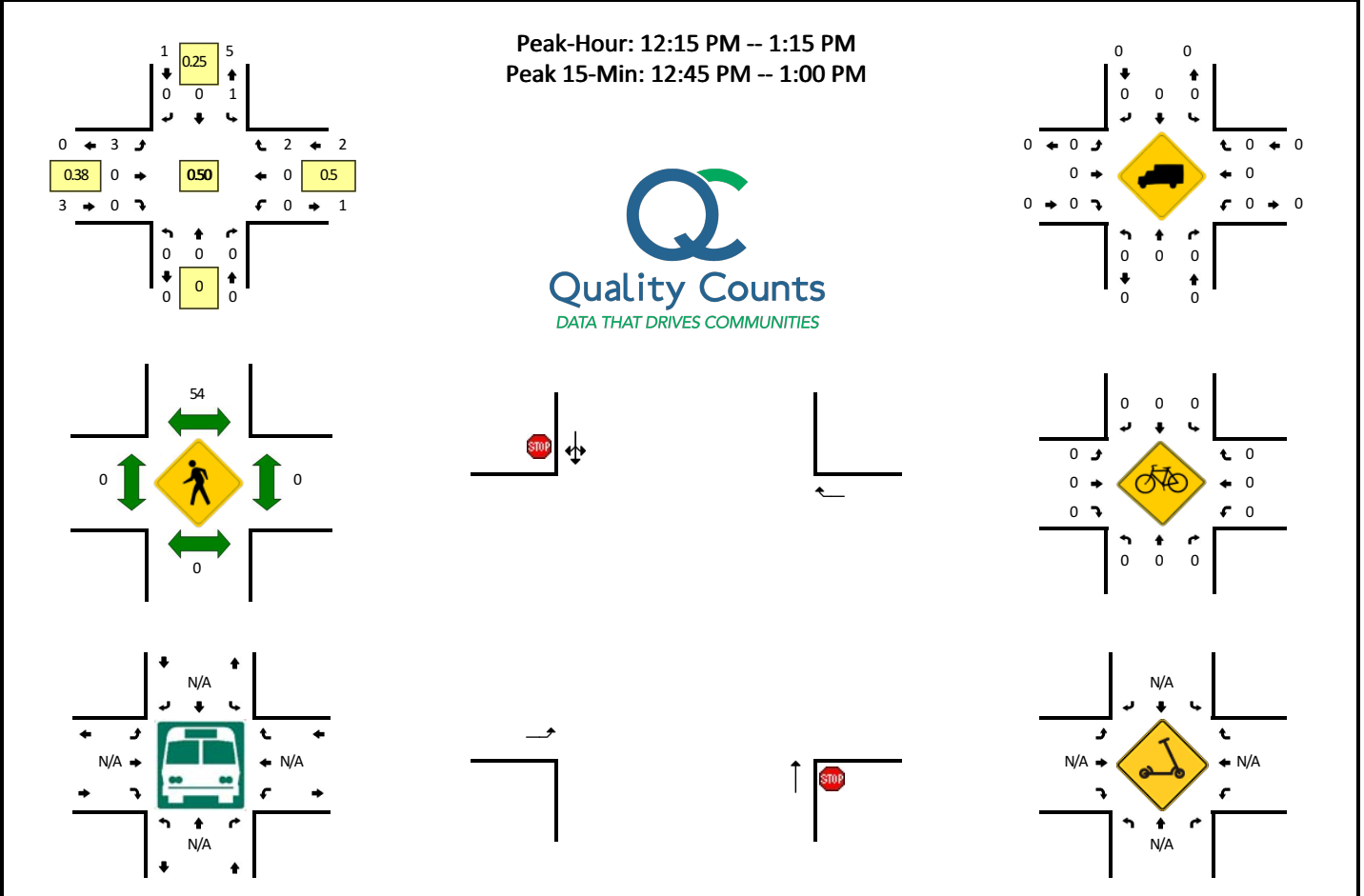

15-Min Count Period Beginning At	Surface Lot (Northbound)				Surface Lot (Southbound)				Rosemary St (Eastbound)				Rosemary St (Westbound)				Total	Hourly Totals
	Left	Thru	Right	U	Left	Thru	Right	U	Left	Thru	Right	U	Left	Thru	Right	U		
11:30 AM	0	0	0	0	1	0	2	0	0	0	0	0	0	0	0	0	3	
11:45 AM	0	0	0	0	2	0	0	0	0	0	0	0	0	0	0	0	2	
12:00 PM	0	0	0	0	0	0	0	0	0	0	0	0	0	0	0	0	0	
12:15 PM	0	0	0	0	0	0	0	0	0	0	0	0	0	0	0	0	0	5
12:30 PM	0	0	0	0	0	0	0	0	1	0	0	0	0	0	0	0	1	3
12:45 PM	0	0	0	0	0	0	0	0	2	0	0	0	0	0	1	0	3	4
1:00 PM	0	0	0	0	1	0	0	0	0	0	0	0	0	0	1	0	2	6
1:15 PM	0	0	0	0	0	0	0	0	0	0	0	0	0	0	0	0	0	6
Peak 15-Min Flowrates	Northbound				Southbound				Eastbound				Westbound				Total	
	Left	Thru	Right	U	Left	Thru	Right	U	Left	Thru	Right	U	Left	Thru	Right	U		
All Vehicles	0	0	0	0	0	0	0	0	8	0	0	0	0	0	4	0	12	
Heavy Trucks	0	0	0	0	0	0	0	0	0	0	0	0	0	0	0	0	0	
Buses																		
Pedestrians		0				24				0				0			24	
Bicycles	0	0	0		0	0	0		0	0	0		0	0	0		0	
Scoters																		

Comments:

LOCATION: Western Wallace Parking Deck Exit -- Rosemary St
CITY/STATE: Chapel Hill, NC

QC JOB #: 15192540
DATE: Tue, Feb 25 2020

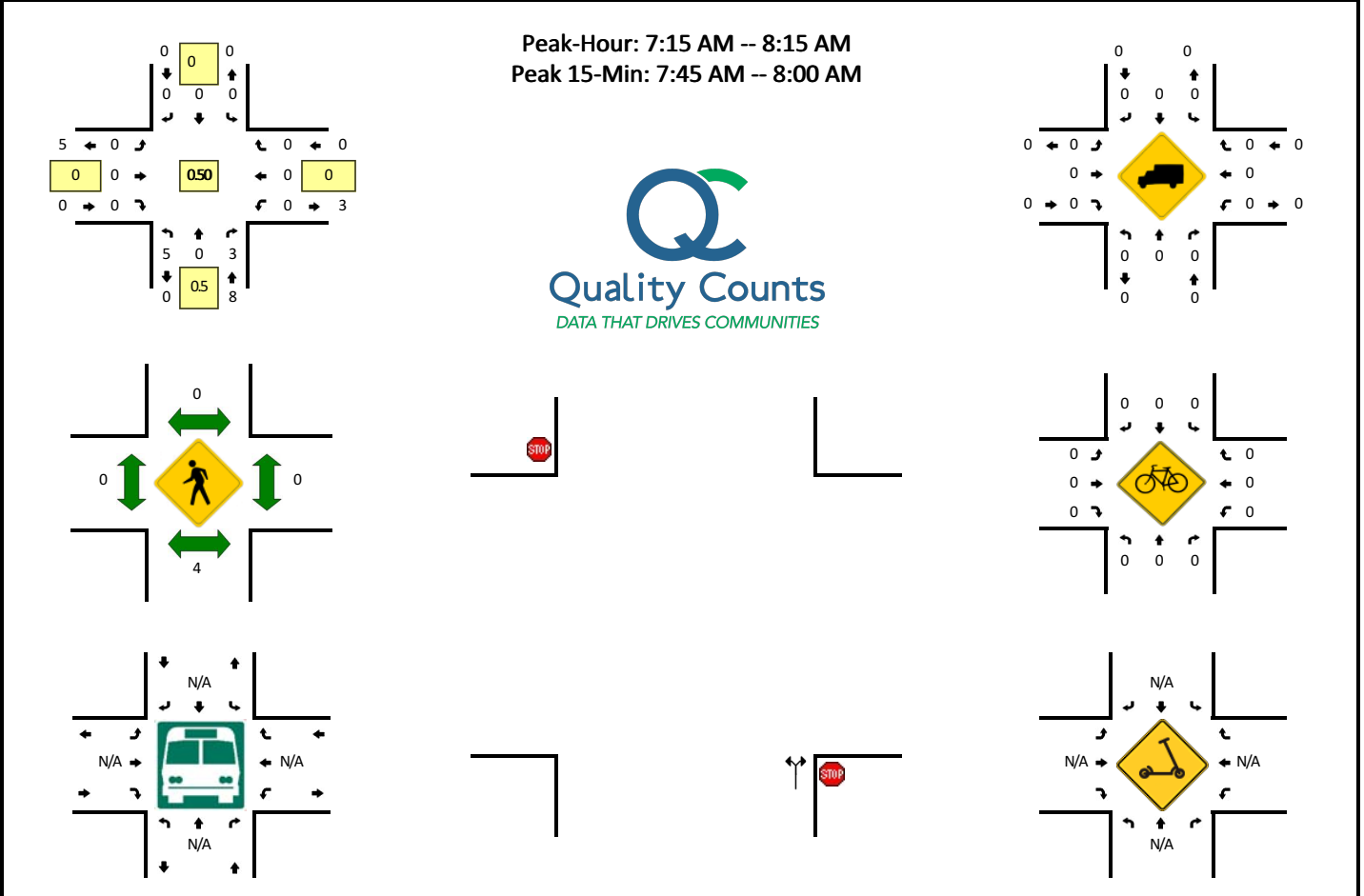

15-Min Count Period Beginning At	Western Wallace Parking Deck Exit (Northbound)				Western Wallace Parking Deck Exit (Southbound)				Rosemary St (Eastbound)				Rosemary St (Westbound)				Total	Hourly Totals
	Left	Thru	Right	U	Left	Thru	Right	U	Left	Thru	Right	U	Left	Thru	Right	U		
7:00 AM	0	0	0	0	0	0	0	0	0	0	0	0	0	0	0	0	0	
7:15 AM	1	0	0	0	0	0	0	0	0	0	0	0	0	0	0	0	1	
7:30 AM	1	0	1	0	0	0	0	0	0	0	0	0	0	0	0	0	2	
7:45 AM	2	0	2	0	0	0	0	0	0	0	0	0	0	0	0	0	4	7
8:00 AM	1	0	0	0	0	0	0	0	0	0	0	0	0	0	0	0	1	8
8:15 AM	1	0	0	0	0	0	0	0	0	0	0	0	0	0	0	0	1	8
8:30 AM	0	0	0	0	0	0	0	0	0	0	0	0	0	0	0	0	0	6
8:45 AM	1	0	1	0	0	0	0	0	0	0	0	0	0	0	0	0	2	4
Peak 15-Min Flowrates	Northbound				Southbound				Eastbound				Westbound				Total	
	Left	Thru	Right	U	Left	Thru	Right	U	Left	Thru	Right	U	Left	Thru	Right	U		
All Vehicles	8	0	8	0	0	0	0	0	0	0	0	0	0	0	0	0	16	
Heavy Trucks	0	0	0	0	0	0	0	0	0	0	0	0	0	0	0	0	0	
Buses																	0	
Pedestrians		0				0				0				0			0	
Bicycles	0	0	0		0	0	0		0	0	0		0	0	0		0	
Scooters																	0	

Comments:

LOCATION: Western Wallace Parking Deck Exit -- Rosemary St
CITY/STATE: Chapel Hill, NC

QC JOB #: 15192541
DATE: Tue, Feb 25 2020

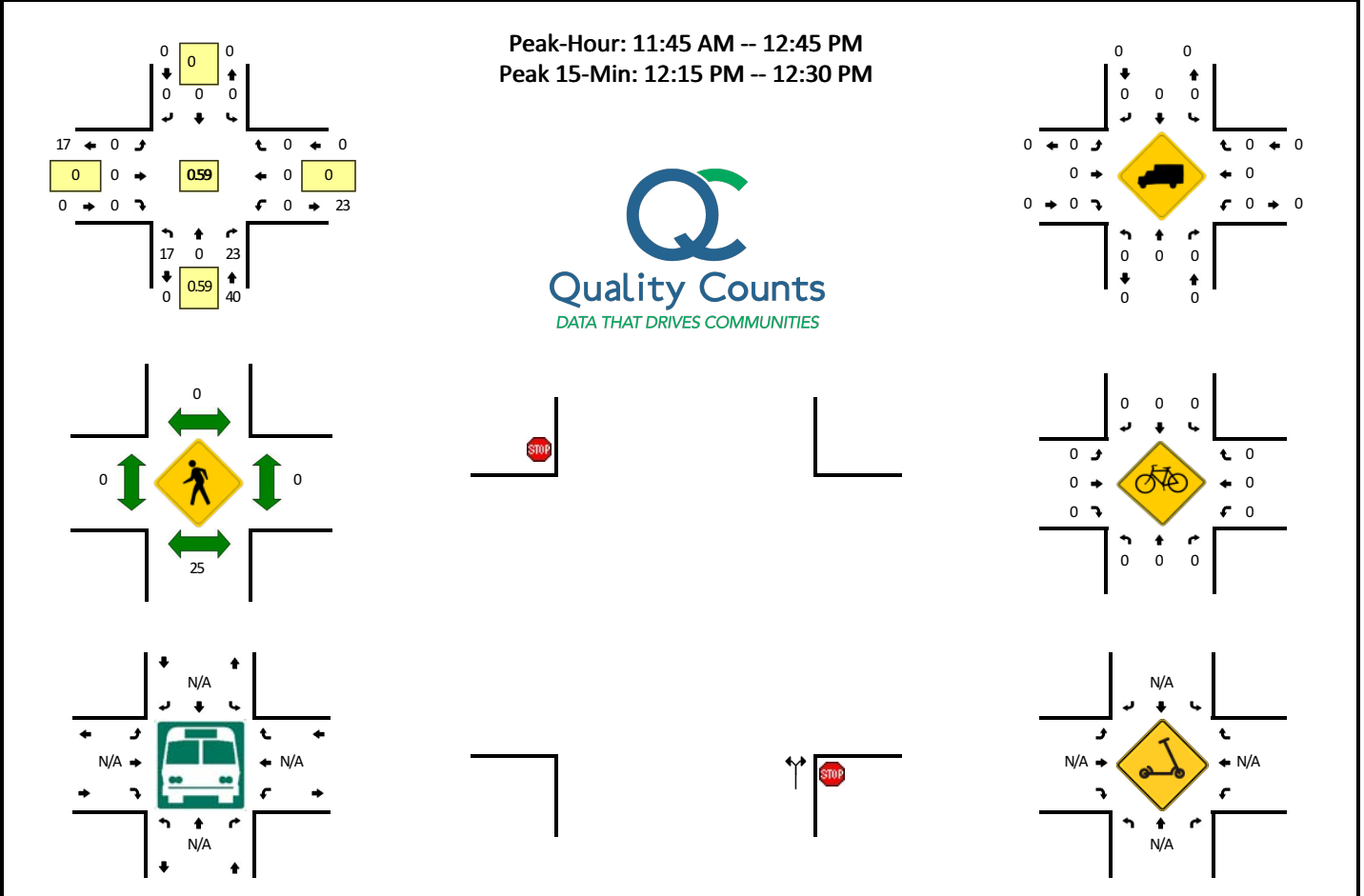

15-Min Count Period Beginning At	Western Wallace Parking Deck Exit (Northbound)				Western Wallace Parking Deck Exit (Southbound)				Rosemary St (Eastbound)				Rosemary St (Westbound)				Total	Hourly Totals
	Left	Thru	Right	U	Left	Thru	Right	U	Left	Thru	Right	U	Left	Thru	Right	U		
11:30 AM	1	0	4	0	0	0	0	0	0	0	0	0	0	0	0	0	5	
11:45 AM	2	0	2	0	0	0	0	0	0	0	0	0	0	0	0	0	4	
12:00 PM	3	0	6	0	0	0	0	0	0	0	0	0	0	0	0	0	9	
12:15 PM	7	0	10	0	0	0	0	0	0	0	0	0	0	0	0	0	17	35
12:30 PM	5	0	5	0	0	0	0	0	0	0	0	0	0	0	0	0	10	40
12:45 PM	1	0	2	0	0	0	0	0	0	0	0	0	0	0	0	0	3	39
1:00 PM	1	0	3	0	0	0	0	0	0	0	0	0	0	0	0	0	4	34
1:15 PM	2	0	2	0	0	0	0	0	0	0	0	0	0	0	0	0	4	21
Peak 15-Min Flowrates	Northbound				Southbound				Eastbound				Westbound				Total	
	Left	Thru	Right	U	Left	Thru	Right	U	Left	Thru	Right	U	Left	Thru	Right	U		
All Vehicles	28	0	40	0	0	0	0	0	0	0	0	0	0	0	0	0	68	
Heavy Trucks	0	0	0		0	0	0		0	0	0		0	0	0		0	
Buses																		
Pedestrians		36				0				0				0			36	
Bicycles	0	0	0		0	0	0		0	0	0		0	0	0		0	
Scoters																		

Comments:

LOCATION: Western Wallace Parking Deck Exit -- Rosemary St
CITY/STATE: Chapel Hill, NC

QC JOB #: 15192542
DATE: Wed, Feb 19 2020

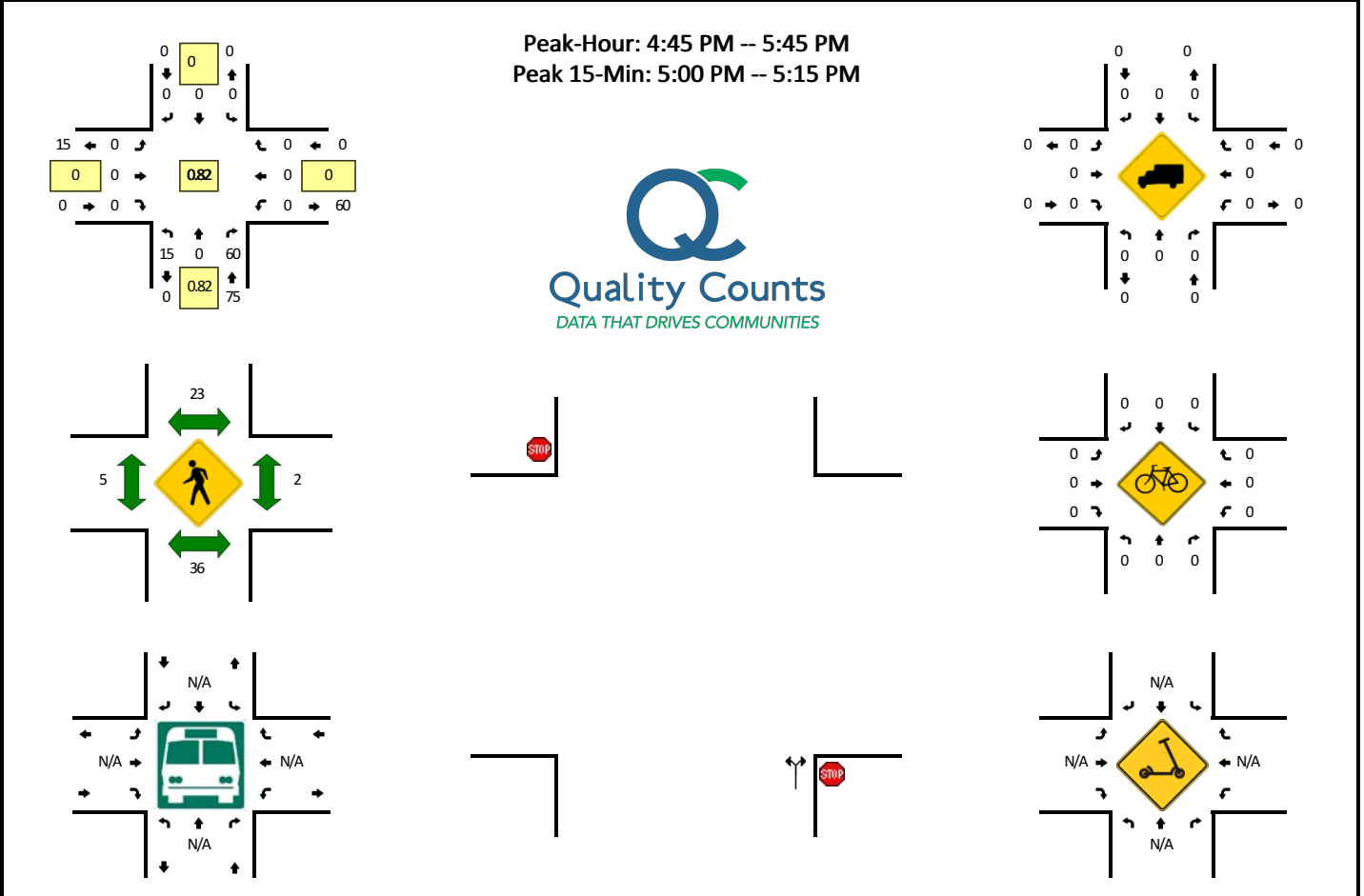

15-Min Count Period Beginning At	Western Wallace Parking Deck Exit (Northbound)				Western Wallace Parking Deck Exit (Southbound)				Rosemary St (Eastbound)				Rosemary St (Westbound)				Total	Hourly Totals	
	Left	Thru	Right	U	Left	Thru	Right	U	Left	Thru	Right	U	Left	Thru	Right	U			
4:00 PM	4	0	7	0	0	0	0	0	0	0	0	0	0	0	0	0	11		
4:15 PM	7	0	11	0	0	0	0	0	0	0	0	0	0	0	0	0	18		
4:30 PM	1	0	9	0	0	0	0	0	0	0	0	0	0	0	0	0	10		
4:45 PM	3	0	19	0	0	0	0	0	0	0	0	0	0	0	0	0	22	61	
5:00 PM	5	0	18	0	0	0	0	0	0	0	0	0	0	0	0	0	23	73	
5:15 PM	5	0	13	0	0	0	0	0	0	0	0	0	0	0	0	0	18	73	
5:30 PM	2	0	10	0	0	0	0	0	0	0	0	0	0	0	0	0	12	75	
5:45 PM	1	0	12	0	0	0	0	0	0	0	0	0	0	0	0	0	13	66	
Peak 15-Min Flowrates	Northbound				Southbound				Eastbound				Westbound				Total		
	Left	Thru	Right	U	Left	Thru	Right	U	Left	Thru	Right	U	Left	Thru	Right	U			
All Vehicles	20	0	72	0	0	0	0	0	0	0	0	0	0	0	0	0	92		
Heavy Trucks	0	0	0		0	0	0		0	0	0		0	0	0		0		
Buses																			
Pedestrians		28				28				4				0			60		
Bicycles	0	0	0		0	0	0		0	0	0		0	0	0		0		
Scoters																			

Comments:

LOCATION: Western Alley -- Rosemary St
CITY/STATE: Chapel Hill, NC

QC JOB #: 15192544
DATE: Tue, Feb 25 2020

Peak-Hour: 12:00 PM -- 1:00 PM
 Peak 15-Min: 12:00 PM -- 12:15 PM

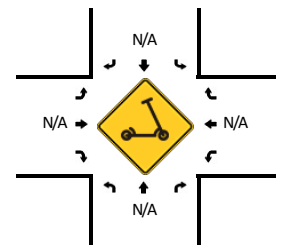
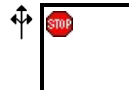
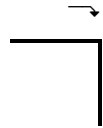
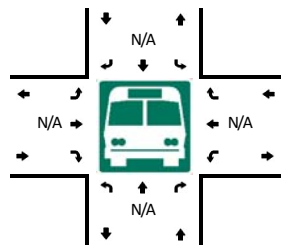
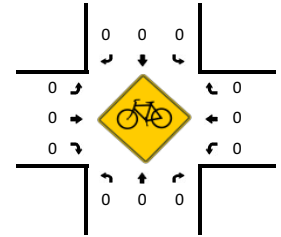
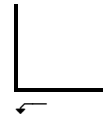
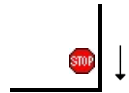
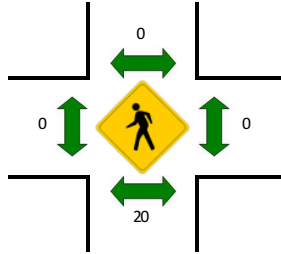
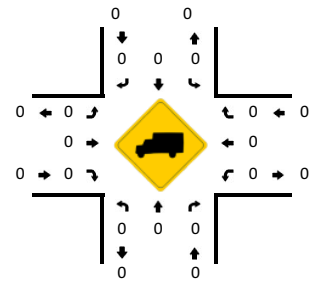
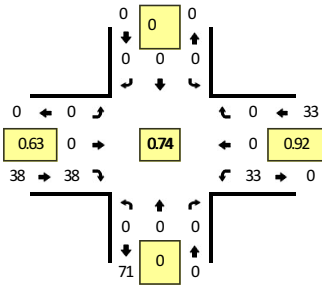

15-Min Count Period Beginning At	Western Alley (Northbound)				Western Alley (Southbound)				Rosemary St (Eastbound)				Rosemary St (Westbound)				Total	Hourly Totals
	Left	Thru	Right	U	Left	Thru	Right	U	Left	Thru	Right	U	Left	Thru	Right	U		
11:30 AM	0	0	0	0	0	0	0	0	0	0	7	0	9	0	0	0	16	
11:45 AM	0	0	0	0	0	0	0	0	0	0	5	0	4	0	0	0	9	
12:00 PM	0	0	0	0	0	0	0	0	0	0	15	0	9	0	0	0	24	
12:15 PM	0	0	0	0	0	0	0	0	0	0	10	0	7	0	0	0	17	66
12:30 PM	0	0	0	0	0	0	0	0	0	0	7	0	9	0	0	0	16	66
12:45 PM	0	0	0	0	0	0	0	0	0	0	6	0	8	0	0	0	14	71
1:00 PM	0	0	0	0	0	0	0	0	0	0	5	0	3	0	0	0	8	55
1:15 PM	0	0	0	0	0	0	0	0	0	0	7	0	9	0	0	0	16	54
Peak 15-Min Flowrates	Northbound				Southbound				Eastbound				Westbound				Total	
	Left	Thru	Right	U	Left	Thru	Right	U	Left	Thru	Right	U	Left	Thru	Right	U		
All Vehicles	0	0	0	0	0	0	0	0	0	0	60	0	36	0	0	0	96	
Heavy Trucks	0	0	0	0	0	0	0	0	0	0	0	0	0	0	0	0	0	
Buses																		
Pedestrians		4				0				0				0			4	
Bicycles	0	0	0		0	0	0		0	0	0		0	0	0		0	
Scoters																		

Comments:

LOCATION: Western Alley -- Rosemary St
CITY/STATE: Chapel Hill, NC

QC JOB #: 15192545
DATE: Wed, Feb 19 2020

Peak-Hour: 5:00 PM -- 6:00 PM
 Peak 15-Min: 5:30 PM -- 5:45 PM

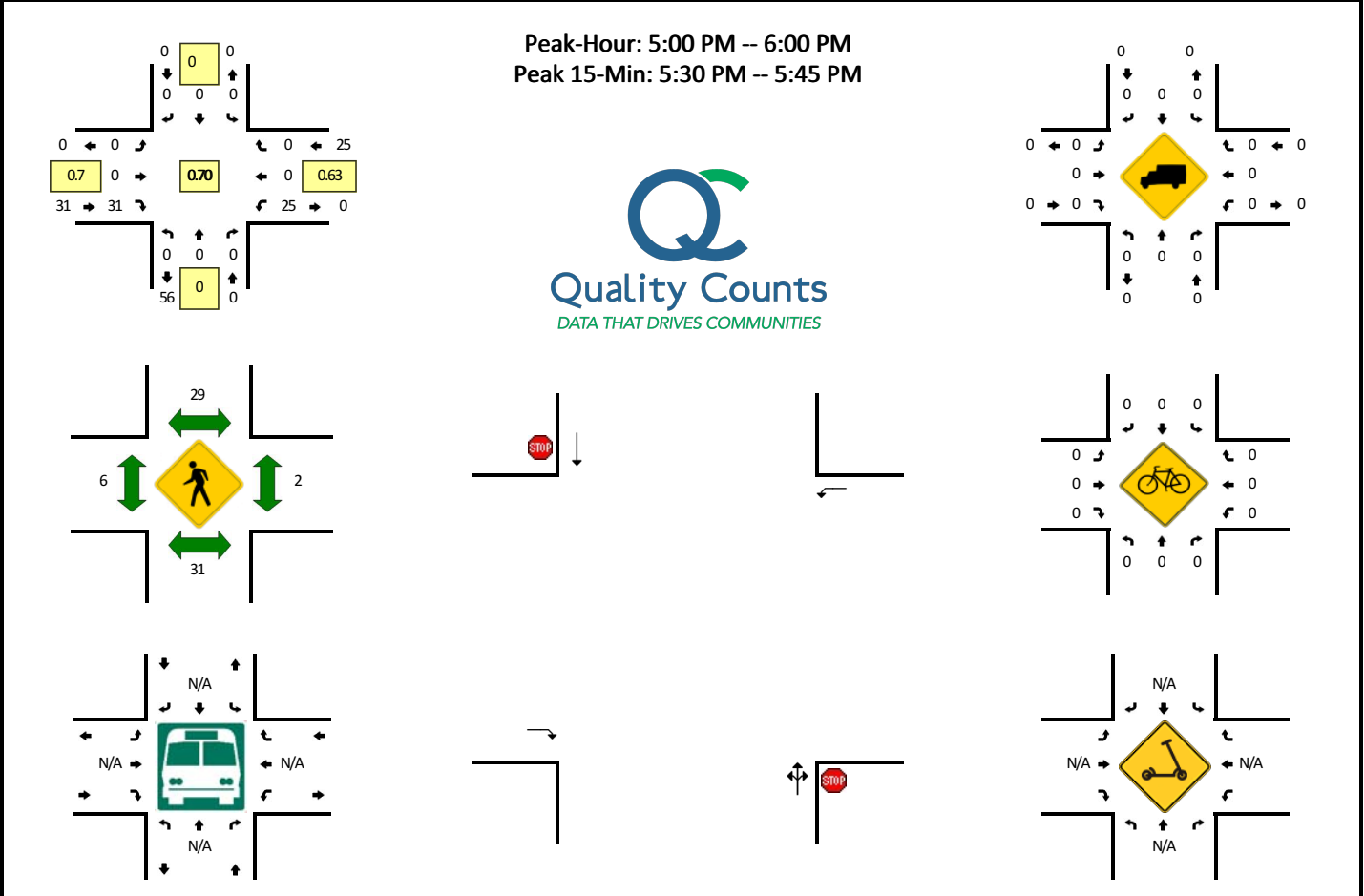

15-Min Count Period Beginning At	Western Alley (Northbound)				Western Alley (Southbound)				Rosemary St (Eastbound)				Rosemary St (Westbound)				Total	Hourly Totals
	Left	Thru	Right	U	Left	Thru	Right	U	Left	Thru	Right	U	Left	Thru	Right	U		
4:00 PM	0	0	0	0	0	0	0	0	0	0	2	0	2	0	0	0	4	
4:15 PM	0	0	0	0	0	0	0	0	0	0	4	0	1	0	0	0	5	
4:30 PM	0	0	0	0	0	0	0	0	0	0	8	0	6	0	0	0	14	
4:45 PM	0	0	0	0	0	0	0	0	0	0	4	0	6	0	0	0	10	33
5:00 PM	0	0	0	0	0	0	0	0	0	0	5	0	3	0	0	0	8	37
5:15 PM	0	0	0	0	0	0	0	0	0	0	7	0	3	0	0	0	10	42
5:30 PM	0	0	0	0	0	0	0	0	0	0	11	0	9	0	0	0	20	48
5:45 PM	0	0	0	0	0	0	0	0	0	0	8	0	10	0	0	0	18	56
Peak 15-Min Flowrates	Northbound				Southbound				Eastbound				Westbound				Total	
	Left	Thru	Right	U	Left	Thru	Right	U	Left	Thru	Right	U	Left	Thru	Right	U		
All Vehicles	0	0	0	0	0	0	0	0	0	0	44	0	36	0	0	0	80	
Heavy Trucks	0	0	0	0	0	0	0	0	0	0	0	0	0	0	0	0	0	
Buses																		
Pedestrians		36				24				12				0			72	
Bicycles	0	0	0		0	0	0		0	0	0		0	0	0		0	
Scooters																		

Comments:

LOCATION: Eastern Wallace Parking Deck Exit -- Rosemary St
CITY/STATE: Chapel Hill, NC

QC JOB #: 15192546
DATE: Tue, Feb 25 2020

Peak-Hour: 7:45 AM -- 8:45 AM
 Peak 15-Min: 8:30 AM -- 8:45 AM

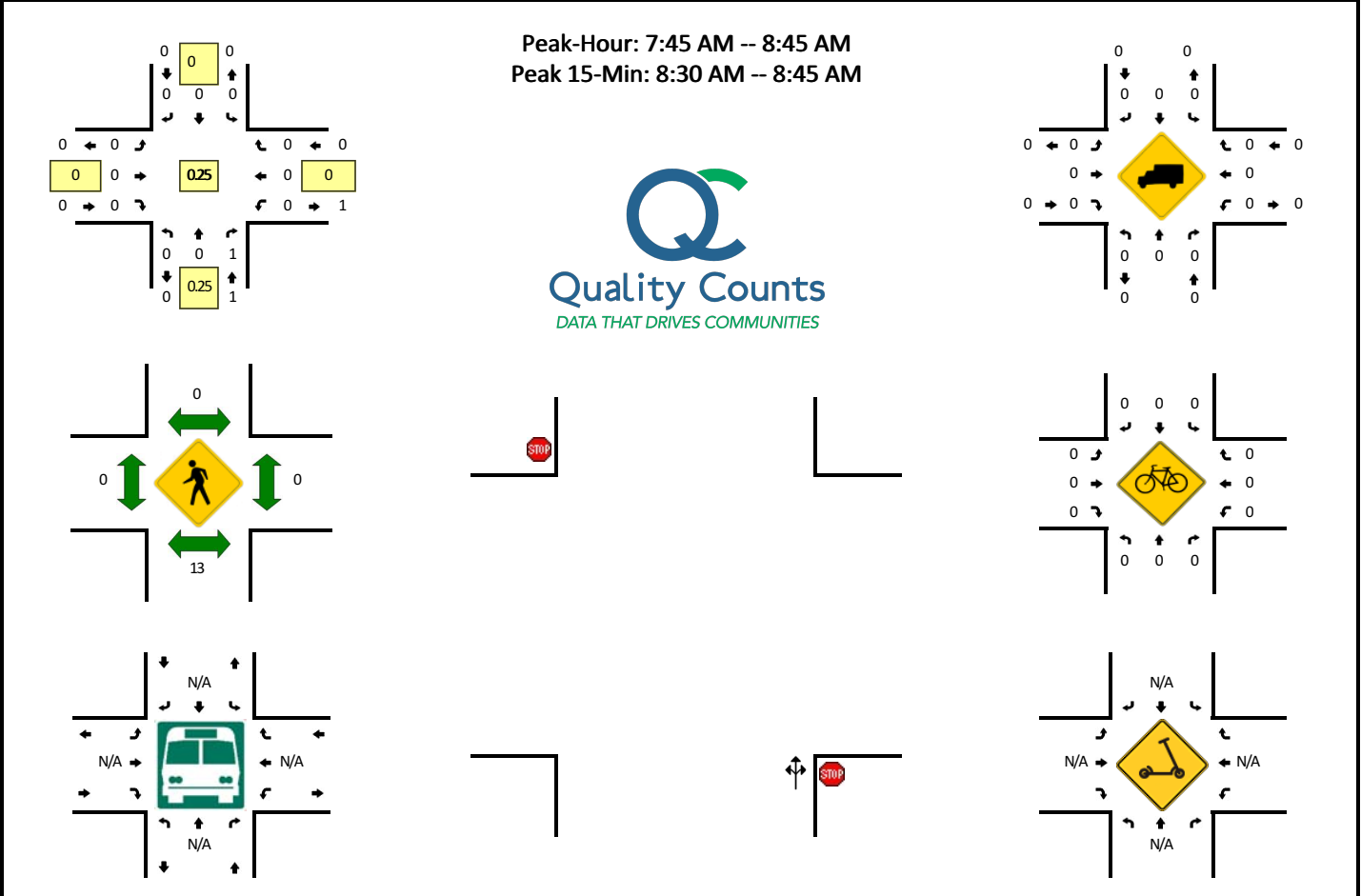

15-Min Count Period Beginning At	Eastern Wallace Parking Deck Exit (Northbound)				Eastern Wallace Parking Deck Exit (Southbound)				Rosemary St (Eastbound)				Rosemary St (Westbound)				Total	Hourly Totals
	Left	Thru	Right	U	Left	Thru	Right	U	Left	Thru	Right	U	Left	Thru	Right	U		
7:00 AM	0	0	0	0	0	0	0	0	0	0	0	0	0	0	0	0	0	
7:15 AM	0	0	0	0	0	0	0	0	0	0	0	0	0	0	0	0	0	
7:30 AM	0	0	0	0	0	0	0	0	0	0	0	0	0	0	0	0	0	
7:45 AM	0	0	0	0	0	0	0	0	0	0	0	0	0	0	0	0	0	0
8:00 AM	0	0	0	0	0	0	0	0	0	0	0	0	0	0	0	0	0	0
8:15 AM	0	0	0	0	0	0	0	0	0	0	0	0	0	0	0	0	0	0
8:30 AM	0	0	1	0	0	0	0	0	0	0	0	0	0	0	0	0	1	1
8:45 AM	0	0	0	0	0	0	0	0	0	0	0	0	0	0	0	0	0	1
Peak 15-Min Flowrates	Northbound				Southbound				Eastbound				Westbound				Total	
	Left	Thru	Right	U	Left	Thru	Right	U	Left	Thru	Right	U	Left	Thru	Right	U		
All Vehicles	0	0	4	0	0	0	0	0	0	0	0	0	0	0	0	0	4	
Heavy Trucks	0	0	0	0	0	0	0	0	0	0	0	0	0	0	0	0	0	
Buses																		
Pedestrians		12				0				0				0			12	
Bicycles	0	0	0		0	0	0		0	0	0		0	0	0		0	
Scooters																		

Comments:

LOCATION: Eastern Wallace Parking Deck Exit -- Rosemary St
CITY/STATE: Chapel Hill, NC

QC JOB #: 15192547
DATE: Tue, Feb 25 2020

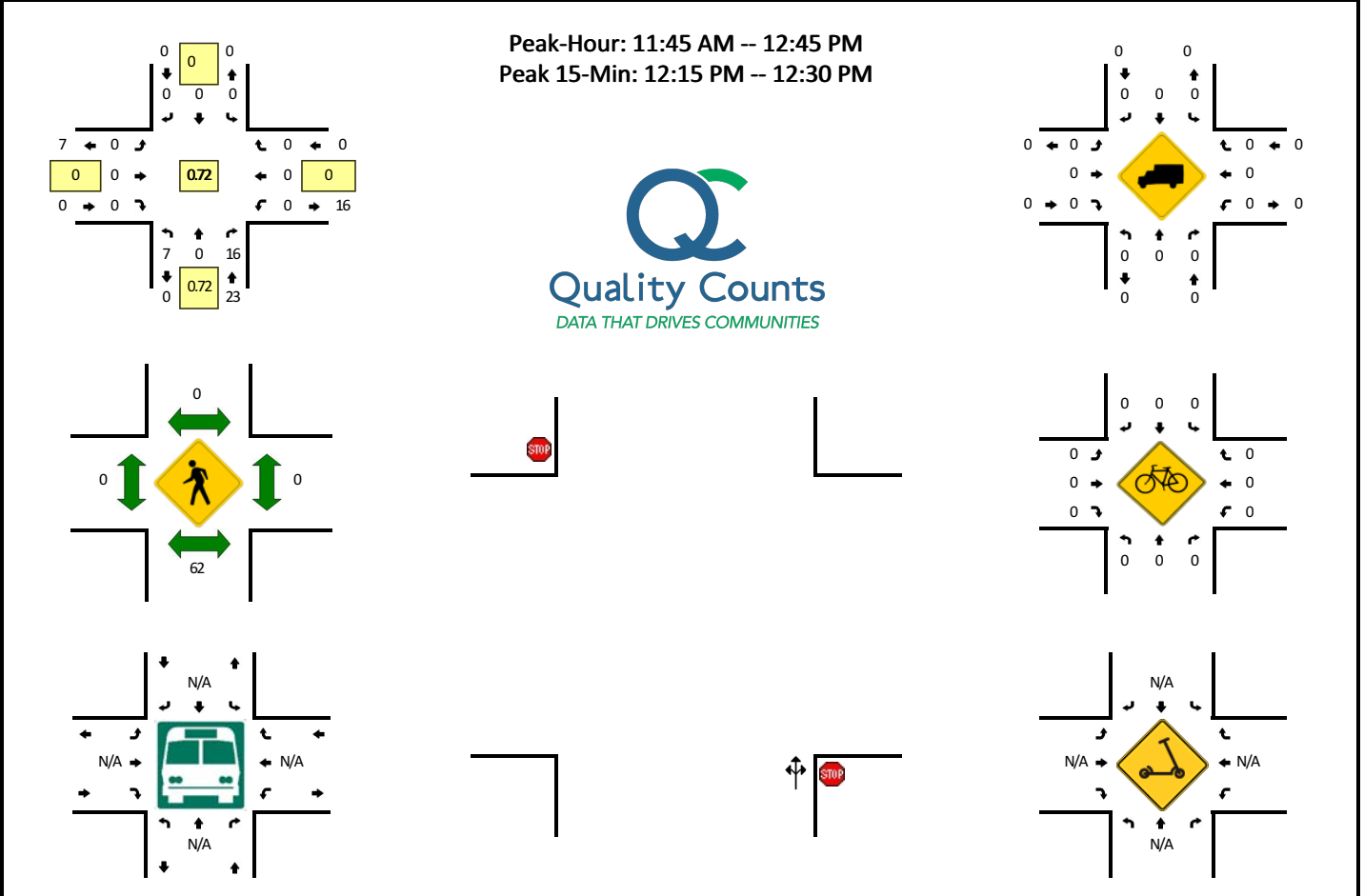

15-Min Count Period Beginning At	Eastern Wallace Parking Deck Exit (Northbound)				Eastern Wallace Parking Deck Exit (Southbound)				Rosemary St (Eastbound)				Rosemary St (Westbound)				Total	Hourly Totals
	Left	Thru	Right	U	Left	Thru	Right	U	Left	Thru	Right	U	Left	Thru	Right	U		
11:30 AM	1	0	1	0	0	0	0	0	0	0	0	0	0	0	0	0	2	
11:45 AM	0	0	2	0	0	0	0	0	0	0	0	0	0	0	0	0	2	
12:00 PM	2	0	3	0	0	0	0	0	0	0	0	0	0	0	0	0	5	
12:15 PM	3	0	5	0	0	0	0	0	0	0	0	0	0	0	0	0	8	17
12:30 PM	2	0	6	0	0	0	0	0	0	0	0	0	0	0	0	0	8	23
12:45 PM	0	0	1	0	0	0	0	0	0	0	0	0	0	0	0	0	1	22
1:00 PM	0	0	0	0	0	0	0	0	0	0	0	0	0	0	0	0	0	17
1:15 PM	1	0	8	0	0	0	0	0	0	0	0	0	0	0	0	0	9	18
Peak 15-Min Flowrates	Northbound				Southbound				Eastbound				Westbound				Total	
	Left	Thru	Right	U	Left	Thru	Right	U	Left	Thru	Right	U	Left	Thru	Right	U		
All Vehicles	12	0	20	0	0	0	0	0	0	0	0	0	0	0	0	0	32	
Heavy Trucks	0	0	0		0	0	0		0	0	0		0	0	0		0	
Buses																		
Pedestrians		84				0				0				0			84	
Bicycles	0	0	0		0	0	0		0	0	0		0	0	0		0	
Scoters																		

Comments:

LOCATION: Eastern Wallace Parking Deck Exit -- Rosemary St
CITY/STATE: Chapel Hill, NC

QC JOB #: 15192548
DATE: Wed, Feb 19 2020

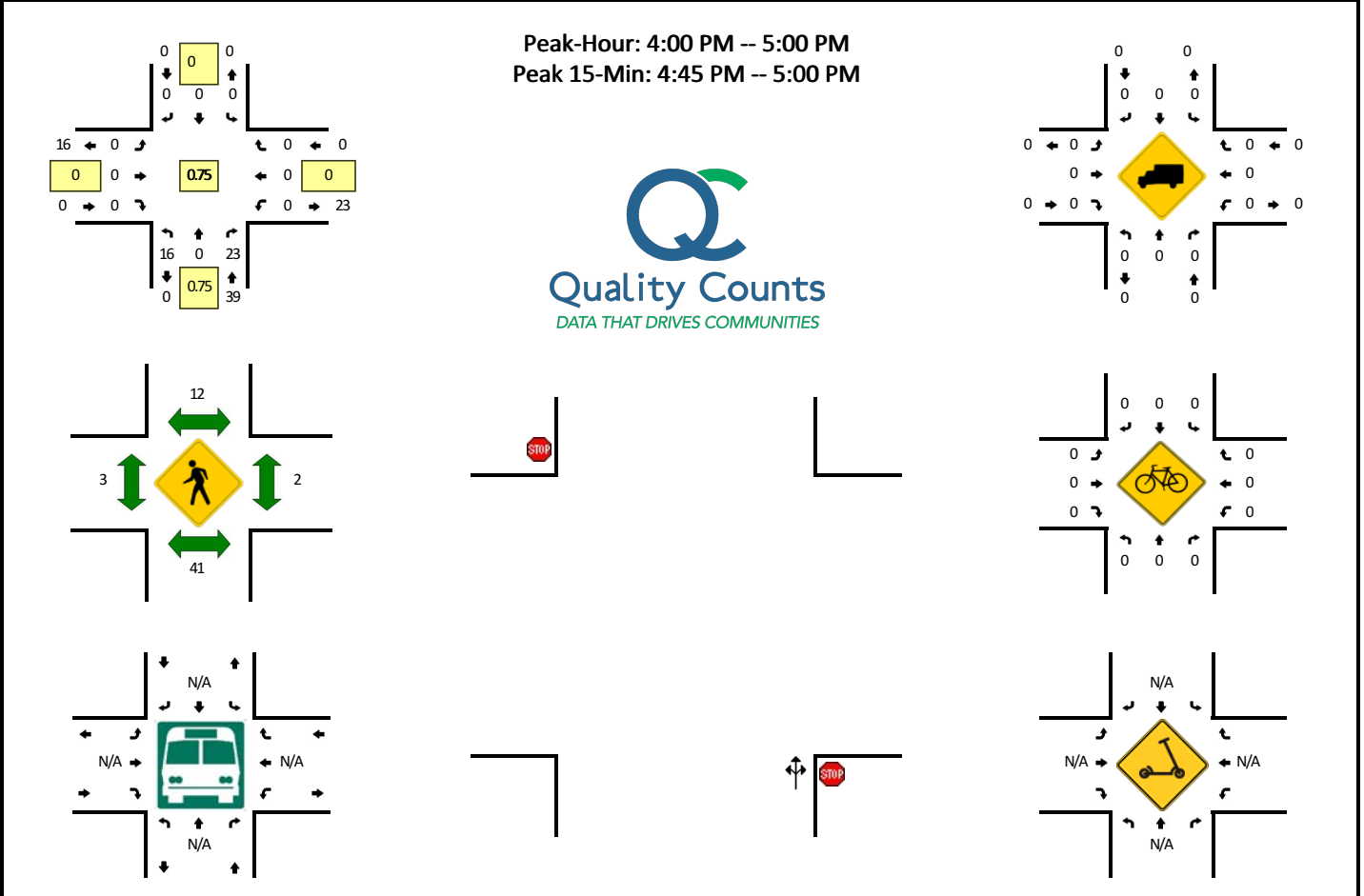

15-Min Count Period Beginning At	Eastern Wallace Parking Deck Exit (Northbound)				Eastern Wallace Parking Deck Exit (Southbound)				Rosemary St (Eastbound)				Rosemary St (Westbound)				Total	Hourly Totals
	Left	Thru	Right	U	Left	Thru	Right	U	Left	Thru	Right	U	Left	Thru	Right	U		
4:00 PM	3	0	7	0	0	0	0	0	0	0	0	0	0	0	0	0	10	
4:15 PM	5	0	4	0	0	0	0	0	0	0	0	0	0	0	0	0	9	
4:30 PM	2	0	5	0	0	0	0	0	0	0	0	0	0	0	0	0	7	
4:45 PM	6	0	7	0	0	0	0	0	0	0	0	0	0	0	0	0	13	39
5:00 PM	1	0	3	0	0	0	0	0	0	0	0	0	0	0	0	0	4	33
5:15 PM	3	0	8	0	0	0	0	0	0	0	0	0	0	0	0	0	11	35
5:30 PM	3	0	2	0	0	0	0	0	0	0	0	0	0	0	0	0	5	33
5:45 PM	4	0	3	0	0	0	0	0	0	0	0	0	0	0	0	0	7	27
Peak 15-Min Flowrates	Northbound				Southbound				Eastbound				Westbound				Total	
	Left	Thru	Right	U	Left	Thru	Right	U	Left	Thru	Right	U	Left	Thru	Right	U		
All Vehicles	24	0	28	0	0	0	0	0	0	0	0	0	0	0	0	0	52	
Heavy Trucks	0	0	0	0	0	0	0	0	0	0	0	0	0	0	0	0	0	
Buses																		
Pedestrians		88				16				4				0			108	
Bicycles	0	0	0		0	0	0		0	0	0		0	0	0		0	
Scooters																		

Comments:

LOCATION: Eastern Alley -- Rosemary St
CITY/STATE: Chapel Hill, NC

QC JOB #: 15192549
DATE: Tue, Feb 25 2020

Peak-Hour: 7:45 AM -- 8:45 AM
 Peak 15-Min: 8:30 AM -- 8:45 AM

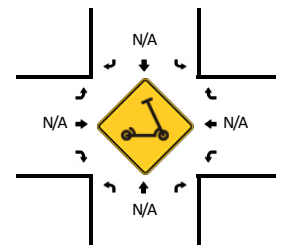
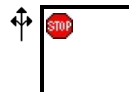
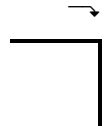
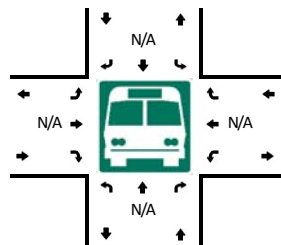
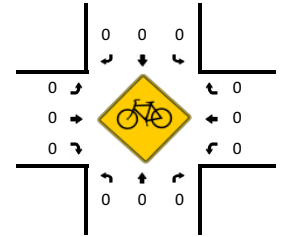
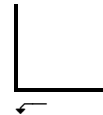
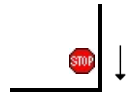
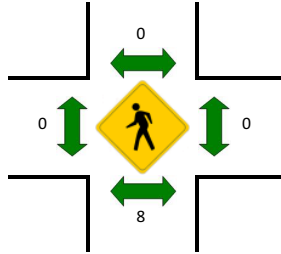
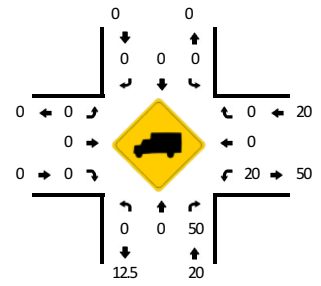
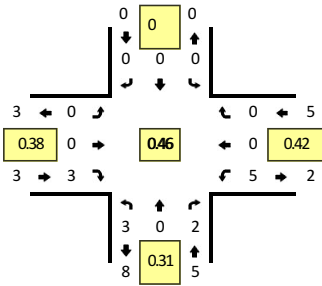

15-Min Count Period Beginning At	Eastern Alley (Northbound)				Eastern Alley (Southbound)				Rosemary St (Eastbound)				Rosemary St (Westbound)				Total	Hourly Totals
	Left	Thru	Right	U	Left	Thru	Right	U	Left	Thru	Right	U	Left	Thru	Right	U		
7:00 AM	0	0	1	0	0	0	0	0	0	0	0	0	0	0	0	0	1	
7:15 AM	0	0	0	0	0	0	0	0	0	0	0	0	0	0	0	0	0	
7:30 AM	0	0	1	0	0	0	0	0	0	0	1	0	0	0	0	0	2	
7:45 AM	0	0	0	0	0	0	0	0	0	0	2	0	1	0	0	0	3	6
8:00 AM	0	0	0	0	0	0	0	0	0	0	1	0	0	0	0	0	1	6
8:15 AM	1	0	0	0	0	0	0	0	0	0	0	0	1	0	0	0	2	8
8:30 AM	2	0	2	0	0	0	0	0	0	0	0	0	3	0	0	0	7	13
8:45 AM	1	0	0	0	0	0	0	0	0	0	0	0	1	0	0	0	2	12
Peak 15-Min Flowrates	Northbound				Southbound				Eastbound				Westbound				Total	
	Left	Thru	Right	U	Left	Thru	Right	U	Left	Thru	Right	U	Left	Thru	Right	U		
All Vehicles	8	0	8	0	0	0	0	0	0	0	0	0	12	0	0	0	28	
Heavy Trucks	0	0	4		0	0	0		0	0	0		0	0	0		4	
Buses																		
Pedestrians		8				0				0				0			8	
Bicycles	0	0	0		0	0	0		0	0	0		0	0	0		0	
Scooters																		

Comments:

LOCATION: Eastern Alley -- Rosemary St
CITY/STATE: Chapel Hill, NC

QC JOB #: 15192550
DATE: Tue, Feb 25 2020

Peak-Hour: 12:15 PM -- 1:15 PM
 Peak 15-Min: 1:00 PM -- 1:15 PM

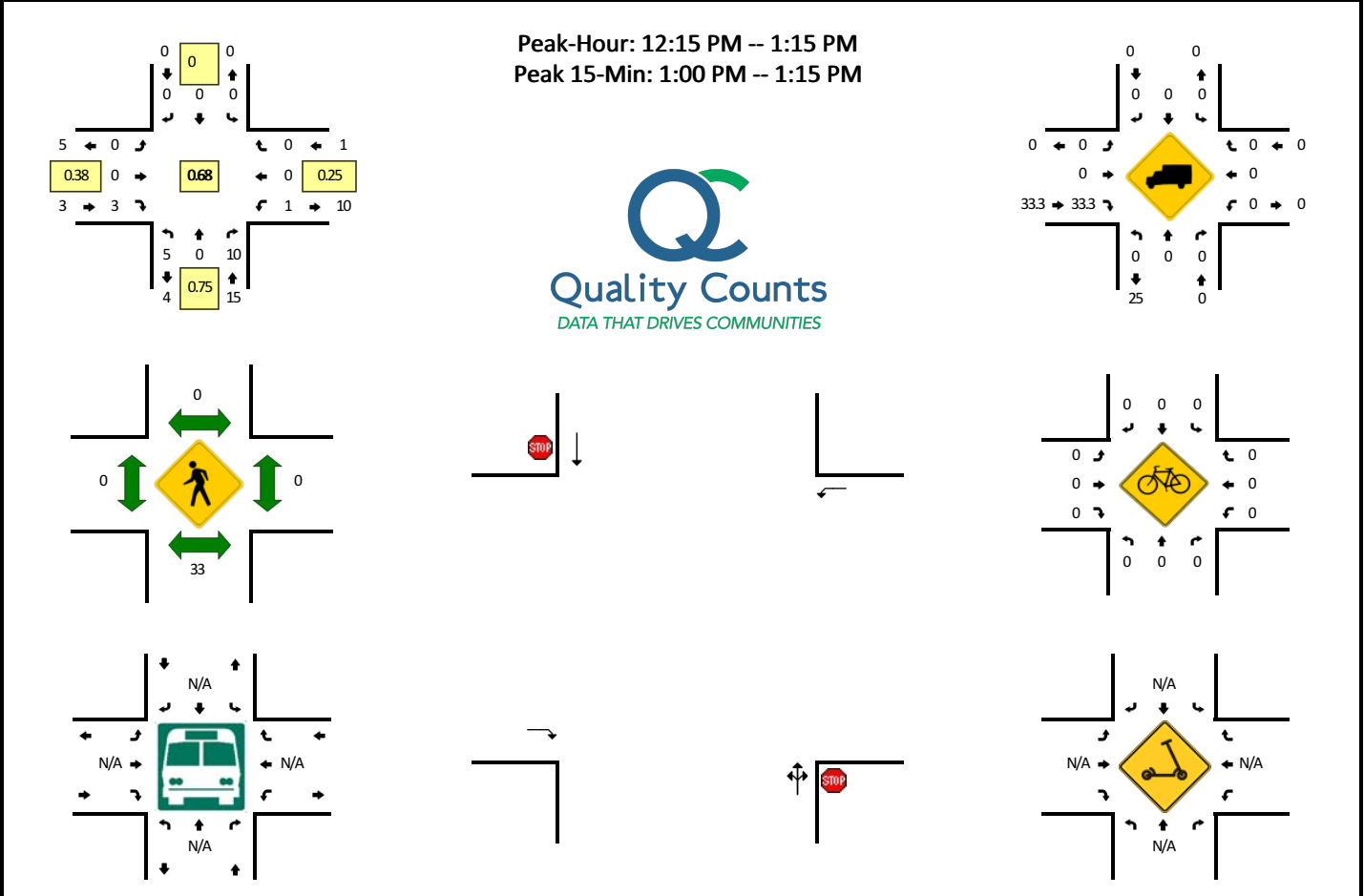

15-Min Count Period Beginning At	Eastern Alley (Northbound)				Eastern Alley (Southbound)				Rosemary St (Eastbound)				Rosemary St (Westbound)				Total	Hourly Totals
	Left	Thru	Right	U	Left	Thru	Right	U	Left	Thru	Right	U	Left	Thru	Right	U		
11:30 AM	0	0	0	0	0	0	0	0	0	0	0	0	0	0	0	0	0	
11:45 AM	1	0	0	0	0	0	0	0	0	0	0	0	0	0	0	0	1	
12:00 PM	2	0	2	0	0	0	0	0	0	0	0	0	0	0	0	0	4	
12:15 PM	1	0	3	0	0	0	0	0	0	0	0	0	0	0	0	0	4	9
12:30 PM	0	0	2	0	0	0	0	0	0	0	0	0	0	0	0	0	2	11
12:45 PM	2	0	2	0	0	0	0	0	0	0	2	0	0	0	0	0	6	16
1:00 PM	2	0	3	0	0	0	0	0	0	0	1	0	1	0	0	0	7	19
1:15 PM	1	0	1	0	0	0	0	0	0	0	0	0	0	0	0	0	2	17
Peak 15-Min Flowrates	Northbound				Southbound				Eastbound				Westbound				Total	
	Left	Thru	Right	U	Left	Thru	Right	U	Left	Thru	Right	U	Left	Thru	Right	U		
All Vehicles	8	0	12	0	0	0	0	0	0	0	4	0	4	0	0	0	28	
Heavy Trucks	0	0	0	0	0	0	0	0	0	0	4	0	0	0	0	0	4	
Buses																		
Pedestrians		56				0				0				0			56	
Bicycles	0	0	0		0	0	0		0	0	0		0	0	0		0	
Scooters																		

Comments:

LOCATION: Eastern Alley -- Rosemary St
CITY/STATE: Chapel Hill, NC

QC JOB #: 15192551
DATE: Wed, Feb 19 2020

Peak-Hour: 4:45 PM -- 5:45 PM
 Peak 15-Min: 4:45 PM -- 5:00 PM

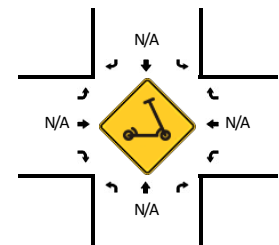
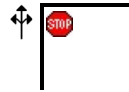
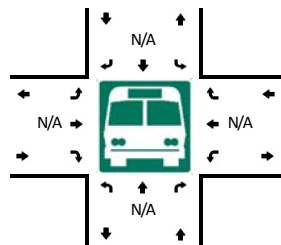
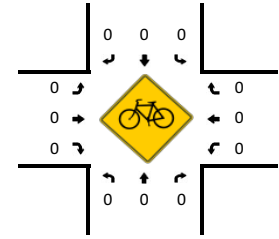
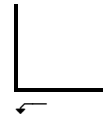
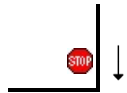
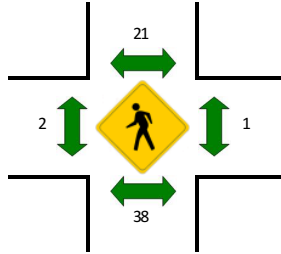
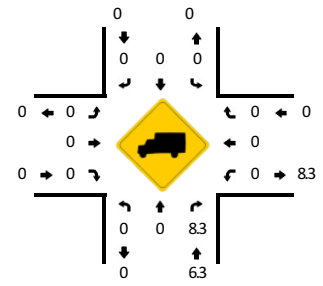
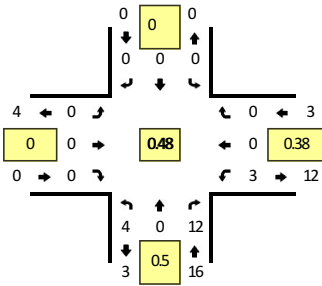

15-Min Count Period Beginning At	Eastern Alley (Northbound)				Eastern Alley (Southbound)				Rosemary St (Eastbound)				Rosemary St (Westbound)				Total	Hourly Totals
	Left	Thru	Right	U	Left	Thru	Right	U	Left	Thru	Right	U	Left	Thru	Right	U		
4:00 PM	1	0	1	0	0	0	0	0	0	0	0	0	1	0	0	0	3	
4:15 PM	1	0	1	0	0	0	0	0	0	0	0	0	0	0	0	0	2	
4:30 PM	1	0	1	0	0	0	0	0	0	0	1	0	0	0	0	0	3	
4:45 PM	3	0	5	0	0	0	0	0	0	0	0	0	2	0	0	0	10	18
5:00 PM	1	0	2	0	0	0	0	0	0	0	0	0	0	0	0	0	3	18
5:15 PM	0	0	2	0	0	0	0	0	0	0	0	0	0	0	0	0	2	18
5:30 PM	0	0	3	0	0	0	0	0	0	0	0	0	1	0	0	0	4	19
5:45 PM	2	0	1	0	0	0	0	0	0	0	0	0	0	0	0	0	3	12
Peak 15-Min Flowrates	Northbound				Southbound				Eastbound				Westbound				Total	
	Left	Thru	Right	U	Left	Thru	Right	U	Left	Thru	Right	U	Left	Thru	Right	U		
All Vehicles	12	0	20	0	0	0	0	0	0	0	0	0	8	0	0	0	40	
Heavy Trucks	0	0	0		0	0	0		0	0	0		0	0	0		0	
Buses																		
Pedestrians		44				16				4				0			64	
Bicycles	0	0	0		0	0	0		0	0	0		0	0	0		0	
Scoters																		

Comments:

LOCATION: Church St -- Franklin St
CITY/STATE: Chapel Hill, NC

QC JOB #: 15192552
DATE: Tue, Feb 25 2020

Peak-Hour: 8:00 AM -- 9:00 AM
 Peak 15-Min: 8:15 AM -- 8:30 AM

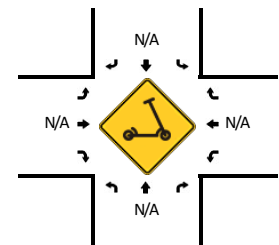
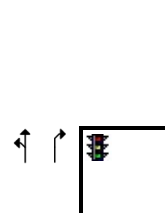
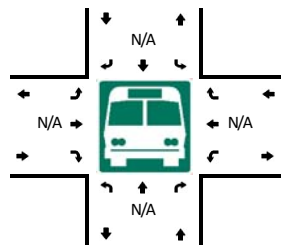
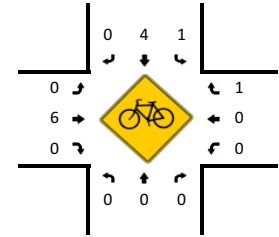
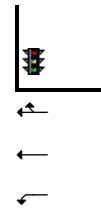
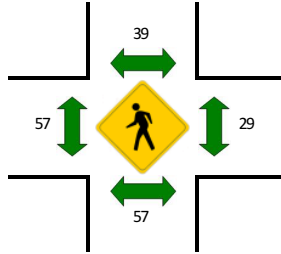
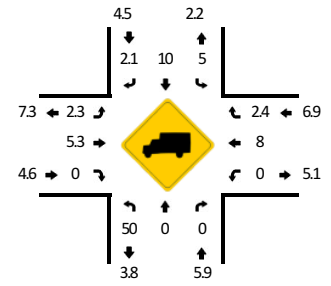
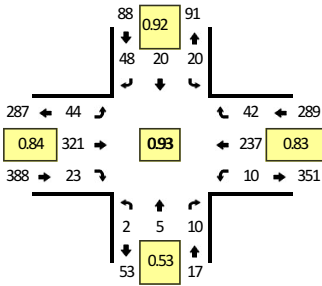

15-Min Count Period Beginning At	Church St (Northbound)				Church St (Southbound)				Franklin St (Eastbound)				Franklin St (Westbound)				Total	Hourly Totals
	Left	Thru	Right	U	Left	Thru	Right	U	Left	Thru	Right	U	Left	Thru	Right	U		
7:00 AM	0	0	0	0	1	0	3	0	2	19	1	0	0	34	4	0	64	
7:15 AM	1	0	1	0	1	1	10	0	5	37	2	0	0	30	5	0	93	
7:30 AM	0	0	5	0	9	3	10	0	13	66	2	0	0	57	10	0	175	
7:45 AM	1	1	3	0	12	4	20	0	4	75	9	0	2	58	5	0	194	526
8:00 AM	0	2	6	0	3	8	10	0	13	61	11	0	2	40	13	0	169	631
8:15 AM	0	0	0	0	4	5	13	0	9	104	3	0	4	59	9	0	210	748
8:30 AM	1	1	2	0	7	3	11	0	13	79	3	0	2	62	11	0	195	768
8:45 AM	1	2	2	0	6	4	14	0	9	77	6	0	2	76	9	0	208	782

Peak 15-Min Flowrates	Northbound				Southbound				Eastbound				Westbound				Total
	Left	Thru	Right	U	Left	Thru	Right	U	Left	Thru	Right	U	Left	Thru	Right	U	
All Vehicles	0	0	0	0	16	20	52	0	36	416	12	0	16	236	36	0	840
Heavy Trucks	0	0	0	0	0	0	0	0	4	16	0	0	0	20	0	0	40
Buses																	
Pedestrians		64				52				48				20			184
Bicycles	0	0	0		4	0	0		0	4	0		0	0	0		8
Scoters																	

Comments:

LOCATION: Church St -- Franklin St
CITY/STATE: Chapel Hill, NC

QC JOB #: 15192553
DATE: Tue, Feb 25 2020

Peak-Hour: 12:00 PM -- 1:00 PM
Peak 15-Min: 12:30 PM -- 12:45 PM

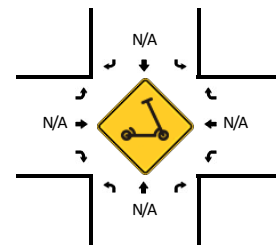
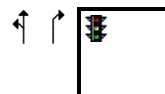
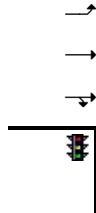
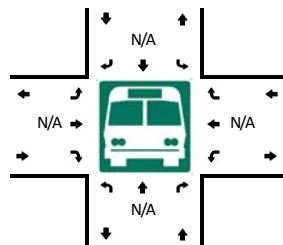
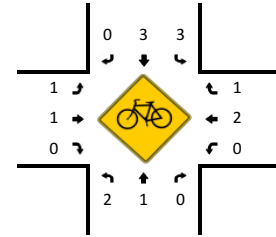
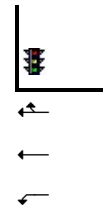
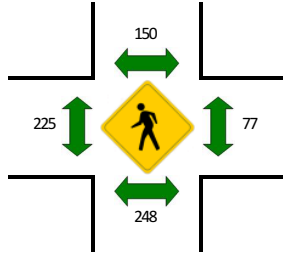
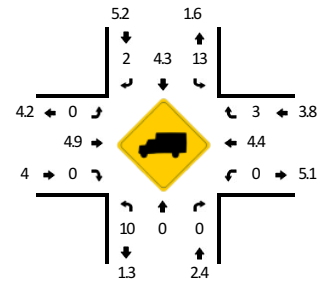
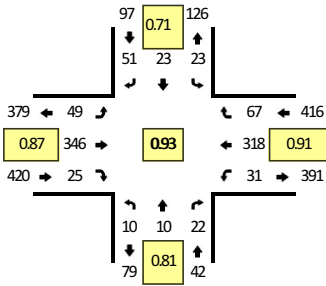

15-Min Count Period Beginning At	Church St (Northbound)				Church St (Southbound)				Franklin St (Eastbound)				Franklin St (Westbound)				Total	Hourly Totals
	Left	Thru	Right	U	Left	Thru	Right	U	Left	Thru	Right	U	Left	Thru	Right	U		
11:30 AM	2	3	7	0	3	3	6	0	6	51	4	0	9	68	9	0	171	
11:45 AM	0	2	6	0	2	4	16	0	6	71	4	0	10	84	9	1	215	
12:00 PM	3	1	5	0	5	10	19	0	12	79	6	0	7	81	13	0	241	
12:15 PM	2	4	4	0	5	5	7	0	7	77	5	0	4	81	18	0	219	846
12:30 PM	4	2	7	0	6	3	13	0	15	92	6	0	12	84	18	0	262	937
12:45 PM	1	3	6	0	7	5	12	0	15	98	8	0	8	72	18	0	253	975
1:00 PM	3	2	4	0	1	2	11	0	13	79	6	0	5	67	14	1	208	942
1:15 PM	1	5	3	0	9	4	12	0	10	82	2	0	6	67	7	0	208	931

Peak 15-Min Flowrates	Northbound				Southbound				Eastbound				Westbound				Total
	Left	Thru	Right	U	Left	Thru	Right	U	Left	Thru	Right	U	Left	Thru	Right	U	
All Vehicles	16	8	28	0	24	12	52	0	60	368	24	0	48	336	72	0	1048
Heavy Trucks	0	0	0		8	0	0		0	20	0		0	16	0		44
Buses																	
Pedestrians		312				160				192				68			732
Bicycles	8	0	0		4	0	0		4	0	0		0	0	0		16
Scoters																	

Comments:

LOCATION: Church St -- Franklin St
CITY/STATE: Chapel Hill, NC

QC JOB #: 15161008
DATE: Tue, Jan 21 2020

Peak-Hour: 5:00 PM -- 6:00 PM
Peak 15-Min: 5:30 PM -- 5:45 PM

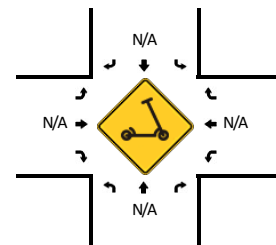
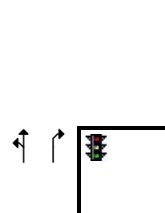
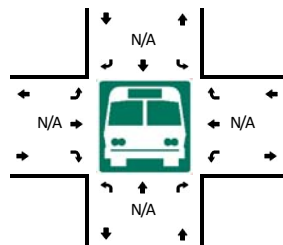
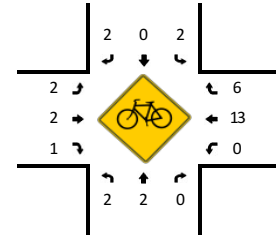
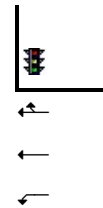
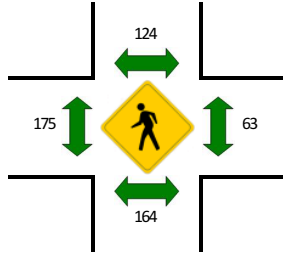
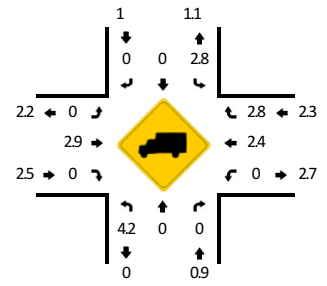
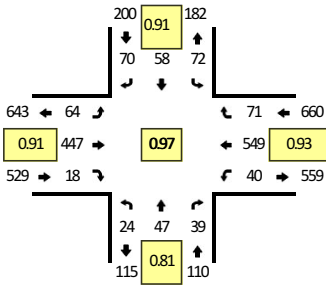

15-Min Count Period Beginning At	Church St (Northbound)				Church St (Southbound)				Franklin St (Eastbound)				Franklin St (Westbound)				Total	Hourly Totals
	Left	Thru	Right	U	Left	Thru	Right	U	Left	Thru	Right	U	Left	Thru	Right	U		
4:00 PM	4	3	6	0	14	4	7	0	6	87	2	0	9	72	11	0	225	
4:15 PM	8	5	6	0	9	17	15	0	13	87	6	0	11	119	26	0	322	
4:30 PM	10	2	4	0	15	6	11	0	8	101	7	0	2	101	17	0	284	
4:45 PM	11	11	9	0	9	6	11	0	11	90	6	0	11	106	16	0	297	1128
5:00 PM	6	16	12	0	19	11	10	0	17	125	4	0	7	125	19	0	371	1274
5:15 PM	9	16	6	0	20	15	20	0	13	112	6	0	13	133	14	0	377	1329
5:30 PM	4	7	11	0	20	16	19	0	15	111	4	0	10	150	17	1	385	1430
5:45 PM	5	8	10	0	13	16	21	0	19	99	4	0	9	141	21	0	366	1499

Peak 15-Min Flowrates	Northbound				Southbound				Eastbound				Westbound				Total
	Left	Thru	Right	U	Left	Thru	Right	U	Left	Thru	Right	U	Left	Thru	Right	U	
All Vehicles	16	28	44	0	80	64	76	0	60	444	16	0	40	600	68	4	1540
Heavy Trucks	0	0	0		0	0	0		0	16	0		0	20	0		36
Buses																	
Pedestrians		172				124				164				92			552
Bicycles	0	0	0		0	0	0		0	0	0		0	4	1		5
Scoters																	

Comments:

LOCATION: Columbia St -- Franklin St
CITY/STATE: Chapel Hill, NC

QC JOB #: 15192555
DATE: Tue, Feb 25 2020

Peak-Hour: 12:00 PM -- 1:00 PM
Peak 15-Min: 12:30 PM -- 12:45 PM

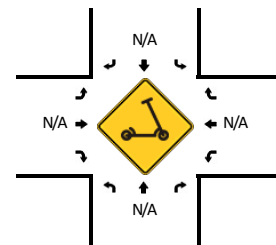
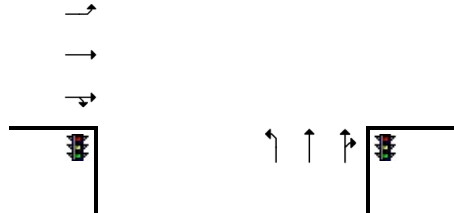
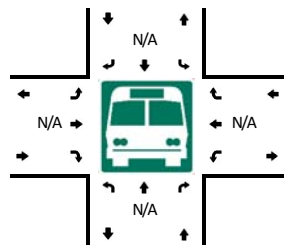
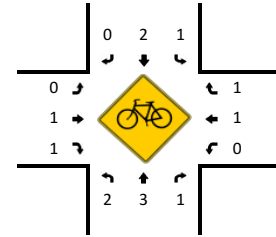
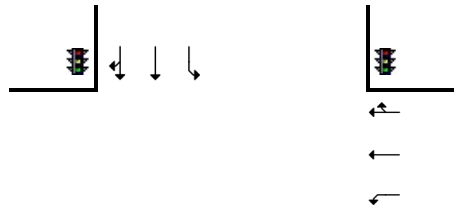
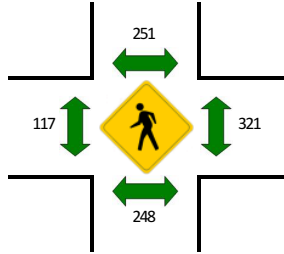
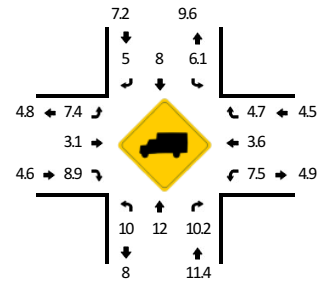
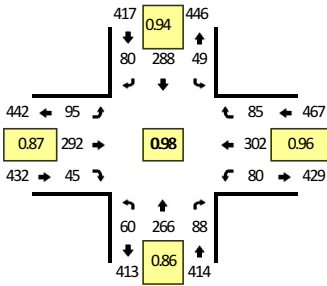

15-Min Count Period Beginning At	Columbia St (Northbound)				Columbia St (Southbound)				Franklin St (Eastbound)				Franklin St (Westbound)				Total	Hourly Totals
	Left	Thru	Right	U	Left	Thru	Right	U	Left	Thru	Right	U	Left	Thru	Right	U		
11:30 AM	11	73	20	0	15	61	16	0	20	40	4	0	10	57	14	0	341	
11:45 AM	12	63	25	0	14	71	21	0	23	59	7	0	13	79	27	0	414	
12:00 PM	10	75	18	0	15	80	16	0	18	70	9	0	23	79	18	0	431	
12:15 PM	17	65	16	0	13	75	23	0	22	73	7	0	26	70	26	0	433	1619
12:30 PM	16	69	36	0	5	75	20	0	21	72	16	0	11	86	16	0	443	1721
12:45 PM	17	57	18	0	16	58	21	0	34	77	13	0	20	67	25	0	423	1730
1:00 PM	11	76	23	0	11	77	23	0	23	60	11	0	15	51	22	0	403	1702
1:15 PM	11	58	12	0	11	70	16	0	31	62	18	0	25	69	18	0	401	1670
Peak 15-Min Flowrates	Northbound				Southbound				Eastbound				Westbound				Total	
	Left	Thru	Right	U	Left	Thru	Right	U	Left	Thru	Right	U	Left	Thru	Right	U		
All Vehicles	64	276	144	0	20	300	80	0	84	288	64	0	44	344	64	0	1772	
Heavy Trucks	4	24	16		0	32	8		8	12	8		4	8	0		124	
Buses		236				308				120				212			876	
Pedestrians	4	4	4		0	0	0		0	0	0		0	4	0		16	
Bicycles																		
Scoters																		

Comments:

LOCATION: Columbia St -- Franklin St
CITY/STATE: Chapel Hill, NC

QC JOB #: 15192554
DATE: Tue, Feb 25 2020

Peak-Hour: 8:00 AM -- 9:00 AM
Peak 15-Min: 8:45 AM -- 9:00 AM

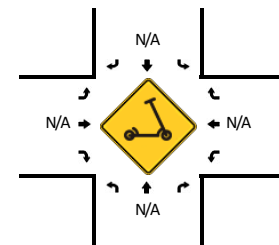
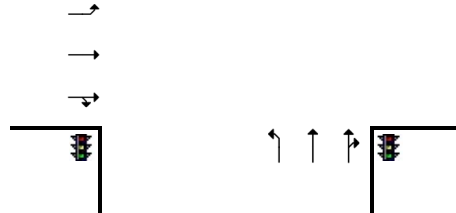
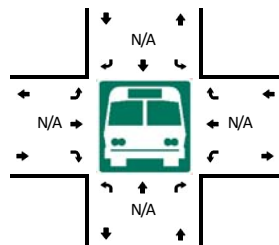
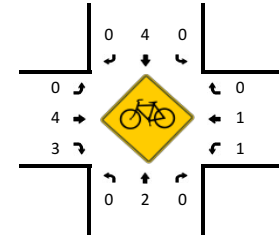
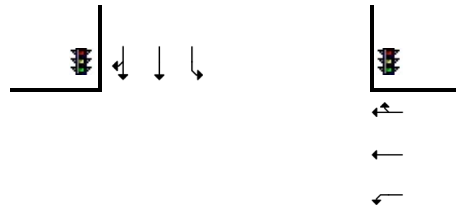
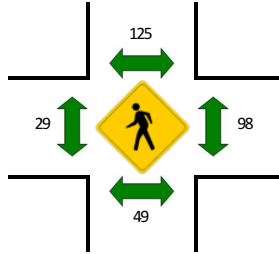
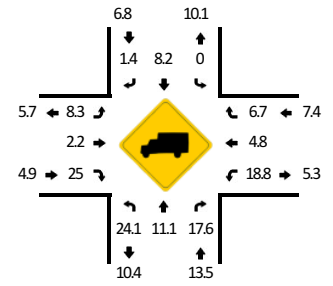
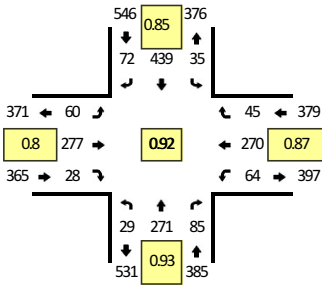

15-Min Count Period Beginning At	Columbia St (Northbound)				Columbia St (Southbound)				Franklin St (Eastbound)				Franklin St (Westbound)				Total	Hourly Totals
	Left	Thru	Right	U	Left	Thru	Right	U	Left	Thru	Right	U	Left	Thru	Right	U		
7:00 AM	5	65	7	0	5	70	3	0	0	16	4	0	7	30	7	0	219	
7:15 AM	4	53	10	0	8	107	6	0	5	31	5	0	11	32	9	0	281	
7:30 AM	12	82	14	0	3	123	17	0	9	54	11	0	14	46	5	0	390	
7:45 AM	5	57	10	0	11	137	11	0	14	69	12	0	17	69	8	0	420	1310
8:00 AM	10	67	20	0	6	105	7	0	10	54	6	0	13	53	6	0	357	1448
8:15 AM	6	64	18	0	5	110	13	0	25	82	7	0	15	69	10	0	424	1591
8:30 AM	10	70	23	0	13	114	13	0	11	69	6	0	20	72	17	0	438	1639
8:45 AM	3	70	24	0	11	110	39	0	14	72	9	0	16	76	12	0	456	1675

Peak 15-Min Flowrates	Northbound				Southbound				Eastbound				Westbound				Total
	Left	Thru	Right	U	Left	Thru	Right	U	Left	Thru	Right	U	Left	Thru	Right	U	
All Vehicles	12	280	96	0	44	440	156	0	56	288	36	0	64	304	48	0	1824
Heavy Trucks	8	36	16		0	28	4		8	4	4		8	8	4		128
Buses																	
Pedestrians		56				152				44				140			392
Bicycles	0	0	0		0	12	0		0	4	8		4	4	0		32
Scoters																	

Comments:

LOCATION: Columbia St -- Franklin St
CITY/STATE: Chapel Hill, NC

QC JOB #: 15161010
DATE: Tue, Jan 21 2020

Peak-Hour: 5:00 PM -- 6:00 PM
Peak 15-Min: 5:15 PM -- 5:30 PM

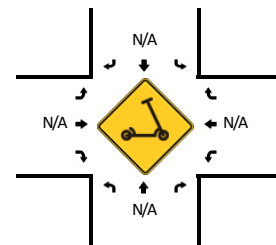
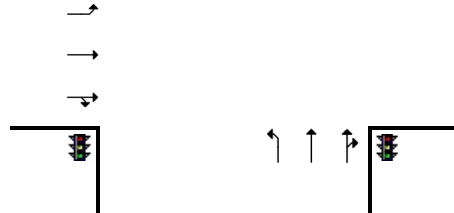
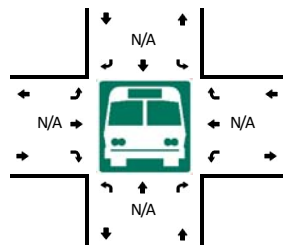
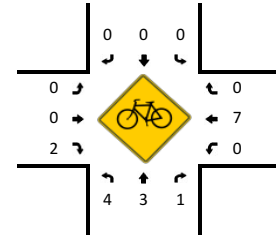
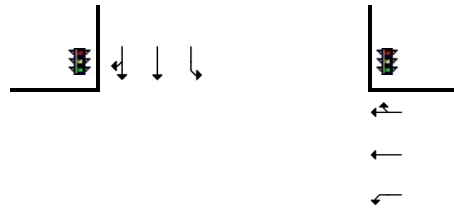
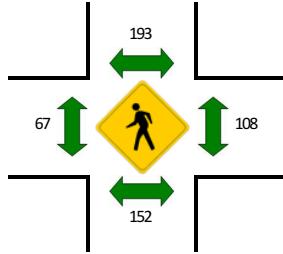
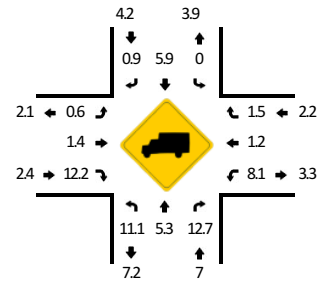
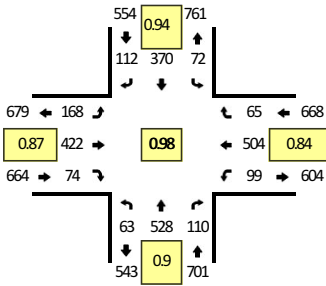

15-Min Count Period Beginning At	Columbia St (Northbound)				Columbia St (Southbound)				Franklin St (Eastbound)				Franklin St (Westbound)				Total	Hourly Totals
	Left	Thru	Right	U	Left	Thru	Right	U	Left	Thru	Right	U	Left	Thru	Right	U		
4:00 PM	15	99	13	0	14	65	14	0	19	95	19	0	24	79	18	0	474	
4:15 PM	15	129	18	0	12	84	29	0	28	88	18	0	14	105	12	0	552	
4:30 PM	14	110	28	0	21	78	19	0	37	98	20	0	16	93	13	0	547	
4:45 PM	18	121	17	0	16	90	14	0	31	92	20	0	21	110	8	0	558	2131
5:00 PM	14	135	25	0	21	98	29	0	52	121	18	0	21	104	15	0	653	2310
5:15 PM	14	141	23	0	20	87	30	0	31	123	21	0	25	126	21	0	662	2420
5:30 PM	21	139	34	0	17	89	28	0	43	89	13	0	20	123	15	0	631	2504
5:45 PM	14	113	28	0	14	96	25	0	42	89	22	0	33	151	14	0	641	2587
Peak 15-Min Flowrates	Northbound				Southbound				Eastbound				Westbound				Total	
	Left	Thru	Right	U	Left	Thru	Right	U	Left	Thru	Right	U	Left	Thru	Right	U		
All Vehicles	56	564	92	0	80	348	120	0	124	492	84	0	100	504	84	0	2648	
Heavy Trucks	8	28	12		0	20	4		4	0	12		0	4	4		96	
Buses		156				252				48				92			548	
Pedestrians	4	1	1		0	0	0		0	0	2		0	3	0		11	
Bicycles																		
Scoters																		

Comments:



Appendix C - Traffic Volume Development Scenarios

E. Rosemary Parking Deck & Office Building Trip Generation

Parking Deck

Facility	ITE LUC	Spaces/Ratio	Daily Estimate			AM Peak Hour			Noon Peak Hour			PM Peak Hour		
			Enter	Exit	Total	Enter	Exit	Total	Enter	Exit	Total	Enter	Exit	Total
Existing Rosemary Deck Counts		285	310	310	620	40	2	42	62	29	91	12	50	62
Existing Private Lot Counts		109	110	110	220	22	0	22	5	1	6	1	18	19
Existing Wallace Deck/Alley Counts		306	945	945	1,890	121	14	135	75	78	153	59	130	189
Existing Columbia/Rosemary Lot 2		104	203	203	406	28	3	31	24	19	43	12	32	44
Existing Total Parking (reallocated to new deck)		804	1,568	1,568	3,136	211	19	230	166	127	293	84	230	314
Proposed Lot Ratios (1100/804)		0.2691	422	422	844	57	5	62	45	34	79	23	62	85
TOTALS - TRIPS TO/FROM NEW DECK			1,990	1,990	3,980	268	24	292	211	161	372	107	292	399

Office Building

Land Use	ITE LUC	Units	Daily			AM Peak Hour			Noon Peak Hour			PM Peak Hour		
			Enter	Exit	Total	Enter	Exit	Total	Enter	Exit	Total	Enter	Exit	Total
General Office Building	710	200K	1,039	1,039	2,078	269	37	306	120	102	222	51	234	285
Transit Reduction		-10%	-104	-104	-208	-27	-4	-31	-12	-10	-22	-5	-23	-28
Pedestrian/Bicycle Reduction		-5%	-52	-52	-104	-13	-2	-15	-6	-5	-11	-3	-12	-15
TOTALS - OFFICE BUILDING VEHICULAR TRIPS			883	883	1,766	229	31	260	102	87	189	43	199	242

 =ITE Peak Hr Generator + Equation Rate/Space

	AM Peak Hour			Noon Peak Hour			PM Peak Hour		
	Enter	Exit	Total	Enter	Exit	Total	Enter	Exit	Total
Rosemary Deck	0.14	0.01	0.15	0.22	0.10	0.32	0.04	0.18	0.22
Wallace Deck	0.40	0.05	0.44	0.25	0.25	0.50	0.19	0.42	0.62
Composite	0.27	0.03	0.30	0.23	0.18	0.41	0.12	0.30	0.42
If Rose	15	1	15	23	11	33	4	18	23
If Wallace	41	5	46	25	27	52	20	44	64
If Composite	28	3	31	24	19	43	12	32	44

Trip Gen Estimates
Town Lot #2
Spaces 104

Parking Deck Allotment Summary

Current Public Spaces	Spaces	Hourly	Leased
Wallace Deck	309	244	65
Lot 2/Rosemary-Columbia Parking Lot		26	
Total Public Spaces		<u>270</u>	<u>65</u>
-Current Private Spaces			
Replace spaces from 137 Deck (CVS)	270	202	68
Replace spaces at 139 E. Rosemary (Inv. Title)			80
Total Private Spaces		<u>202</u>	<u>148</u>
Public and Private existing spaces	685	472	213
Percent Use		69%	31%

NEW DECK 1100 Spaces	Spaces	Hourly	Leased
UNC	100	50	50
Grubb	250		250
Town	750	525	225
Total Public Space New Deck	1100	575	525
Percent use		52%	48%

Trip Assignment proportion to the Office Parking Lot

Office Bldg	200 spaces
Deck Spaces Assigned to Grubb	250 spaces
Minus Spaces Currently Used by CVS	68 spaces
Net Spaces for Office Bldg in Deck	182

Trips to be assigned to Office Bldg Parking **52%**
 Trips to be assigned to Deck Parking and already included in Deck trip generation 48%

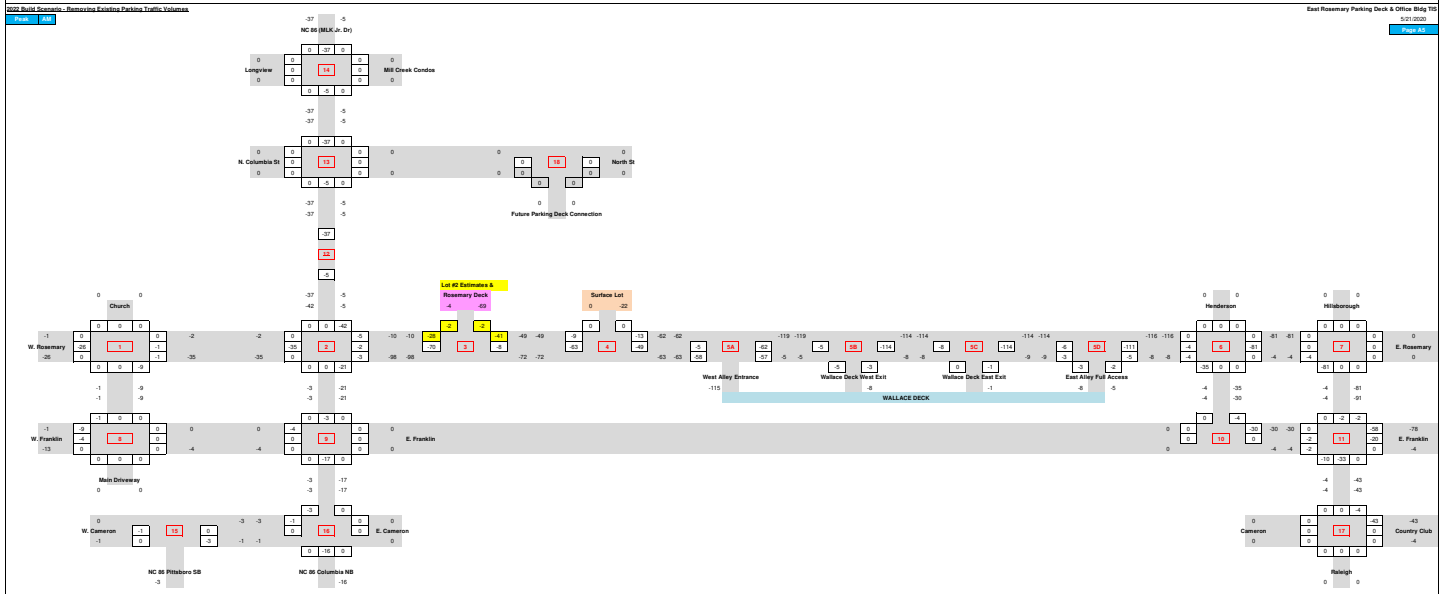
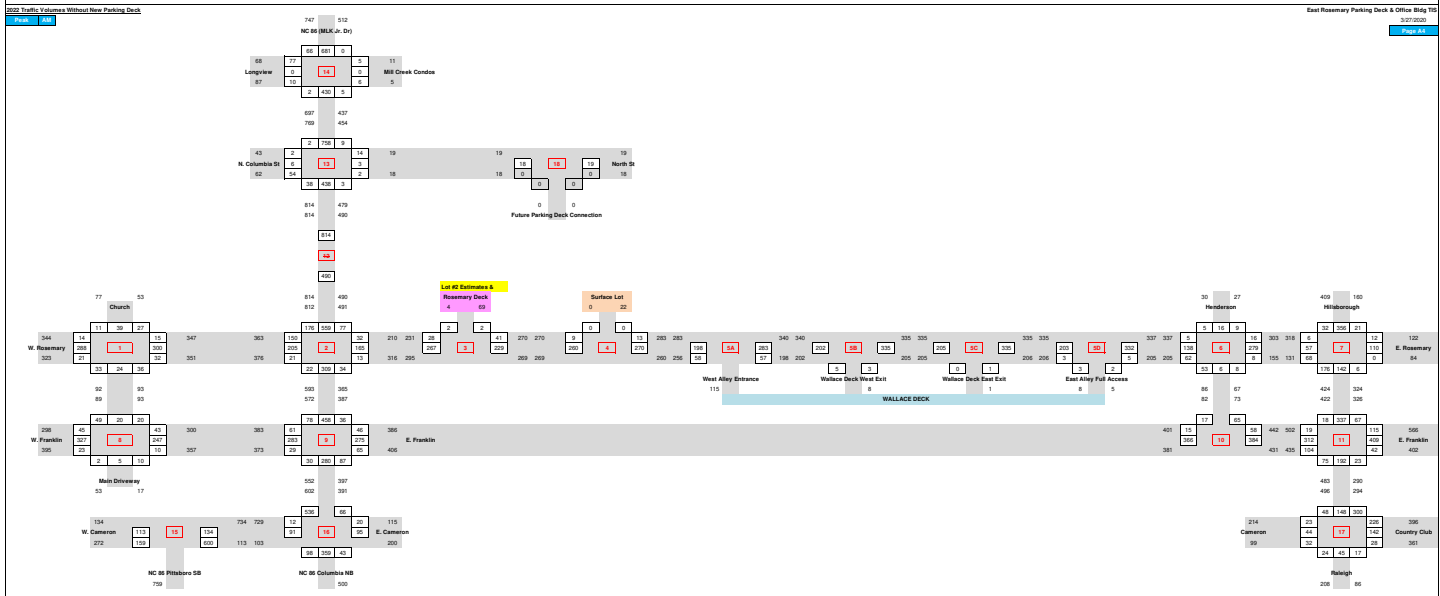
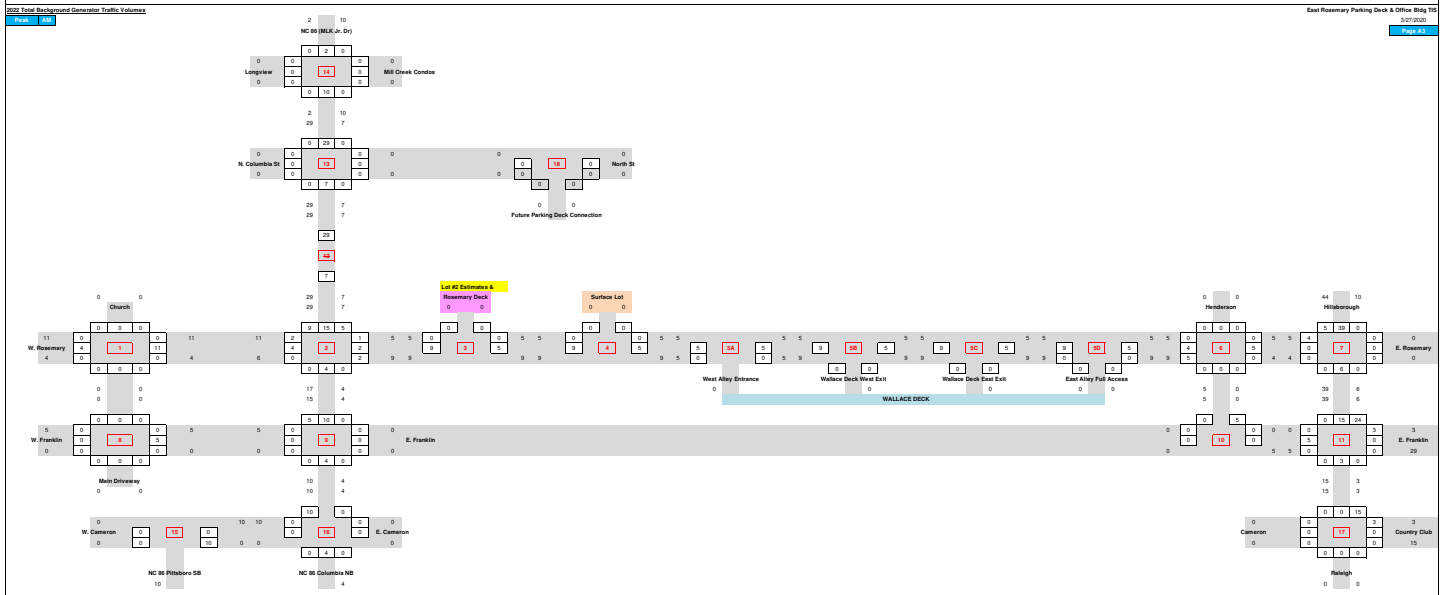
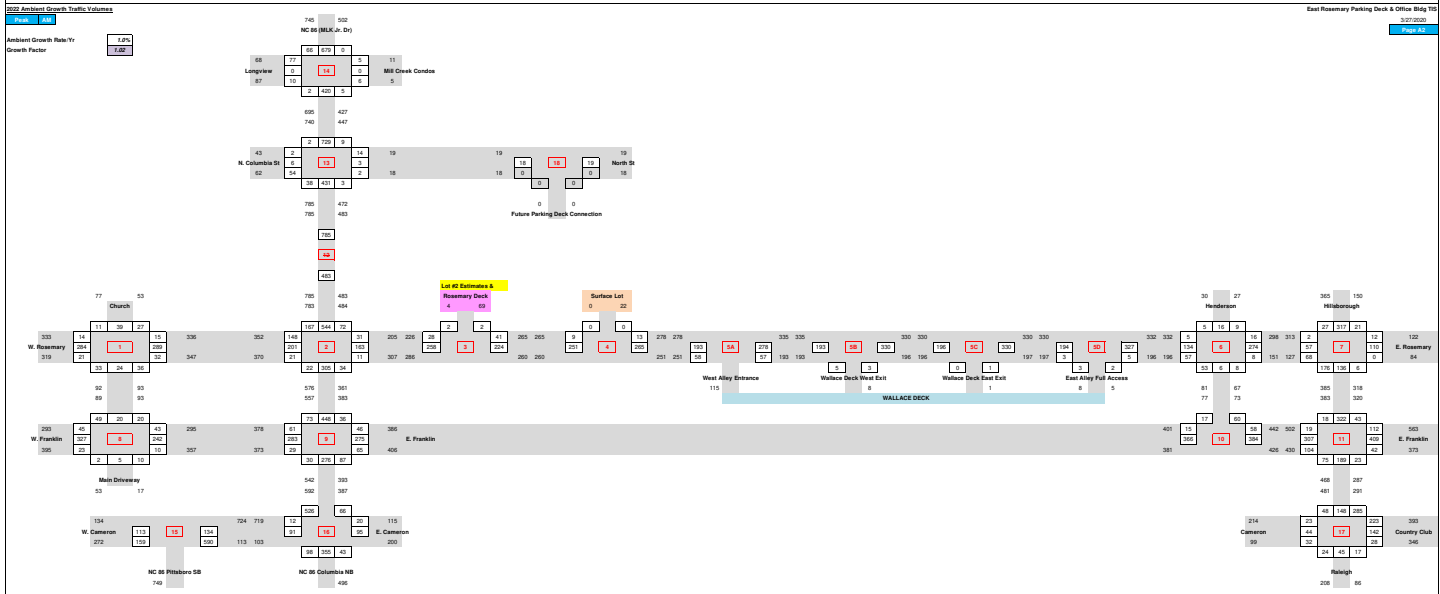
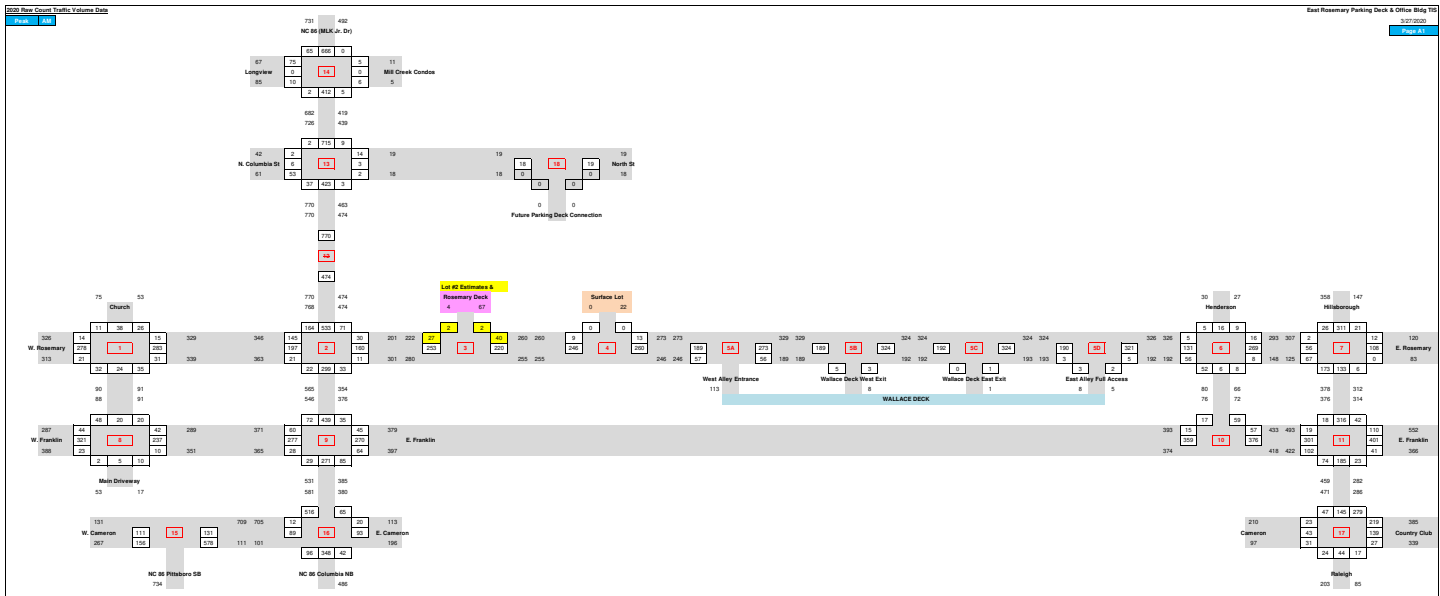

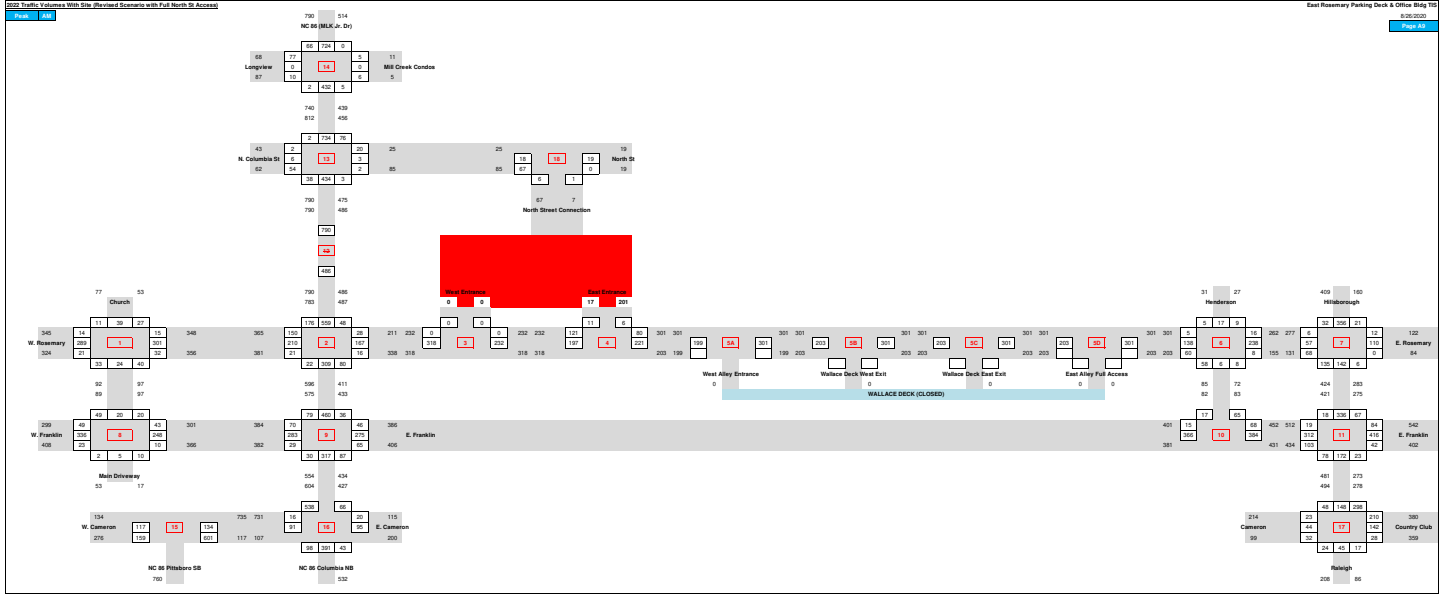
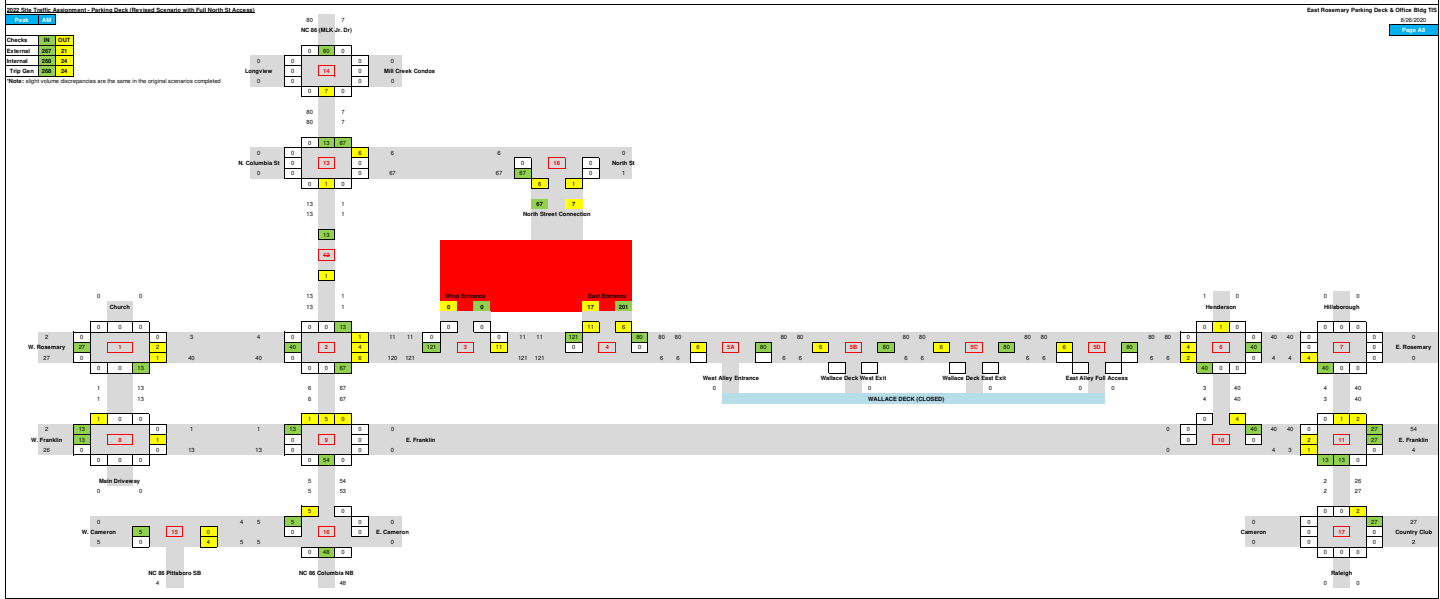
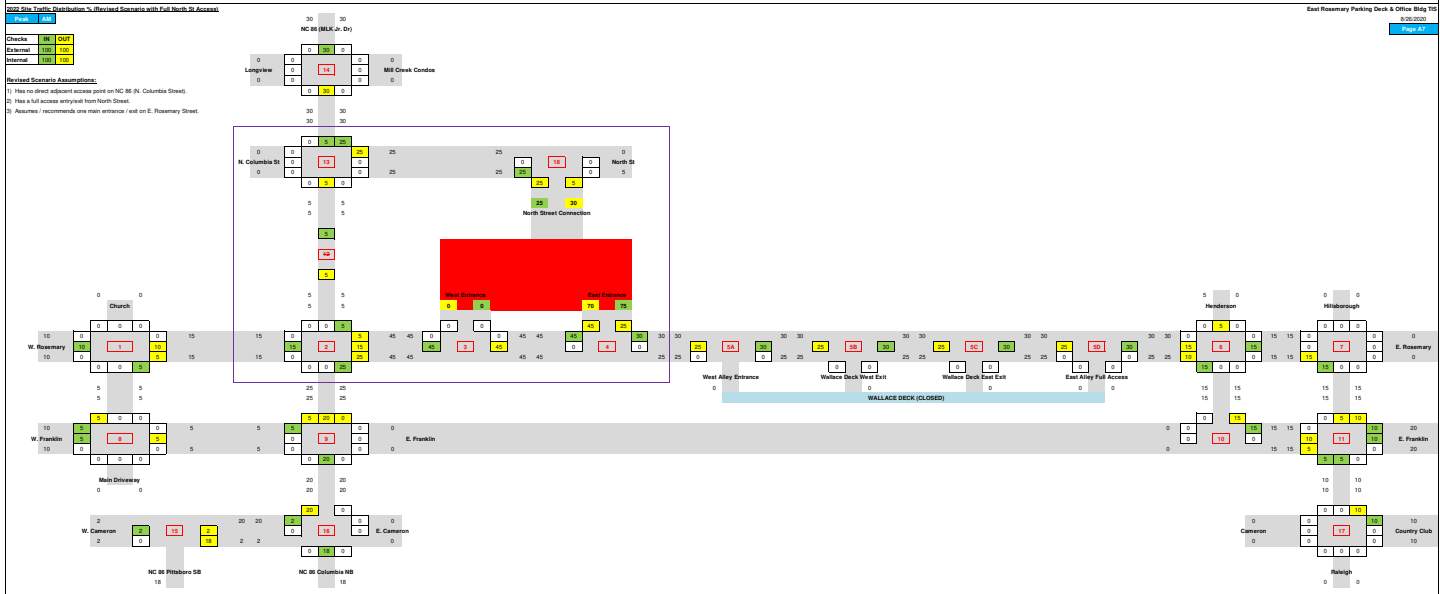
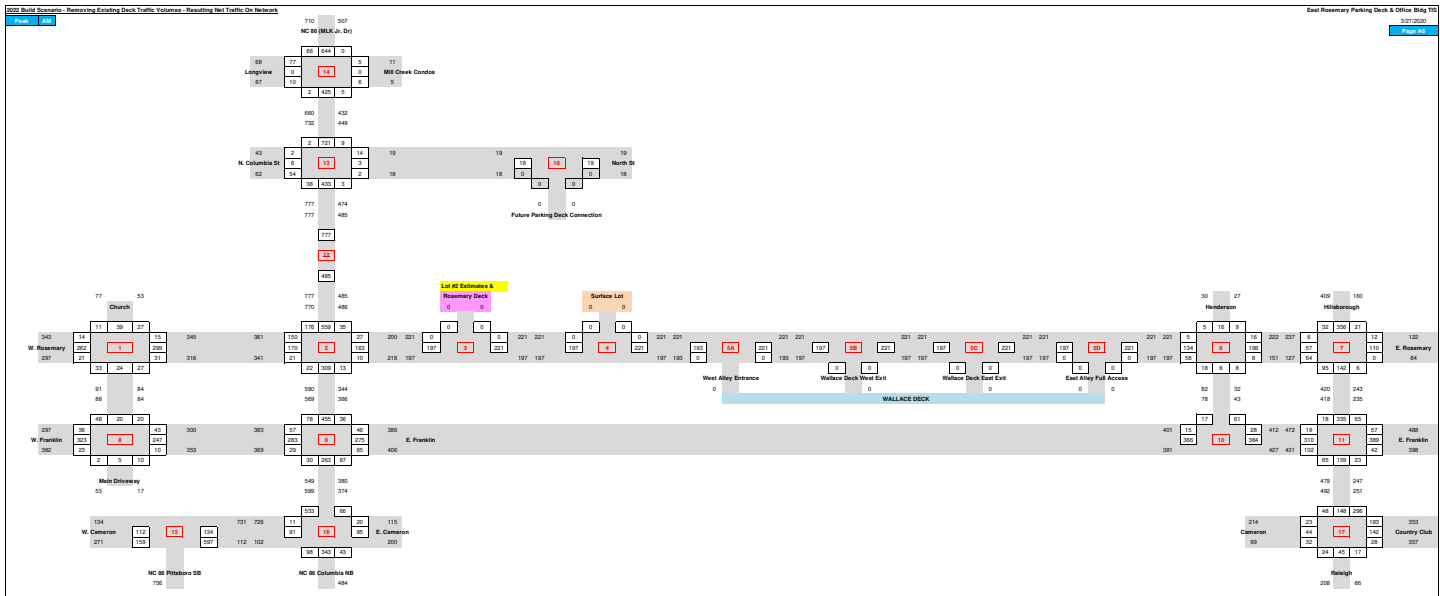

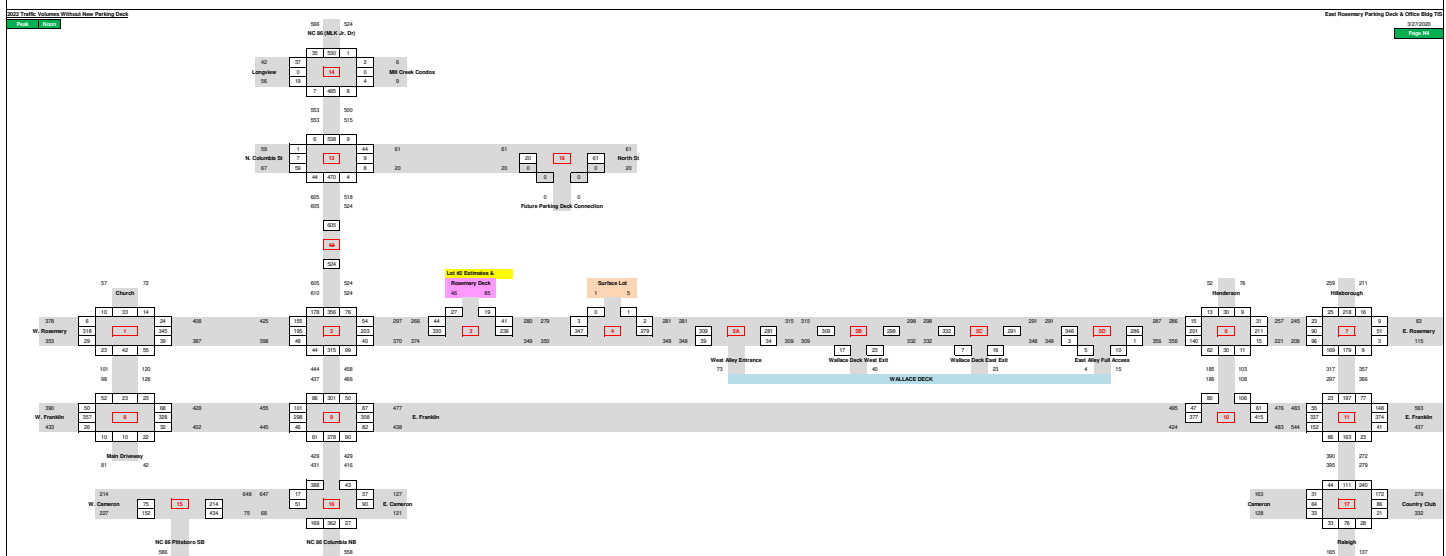
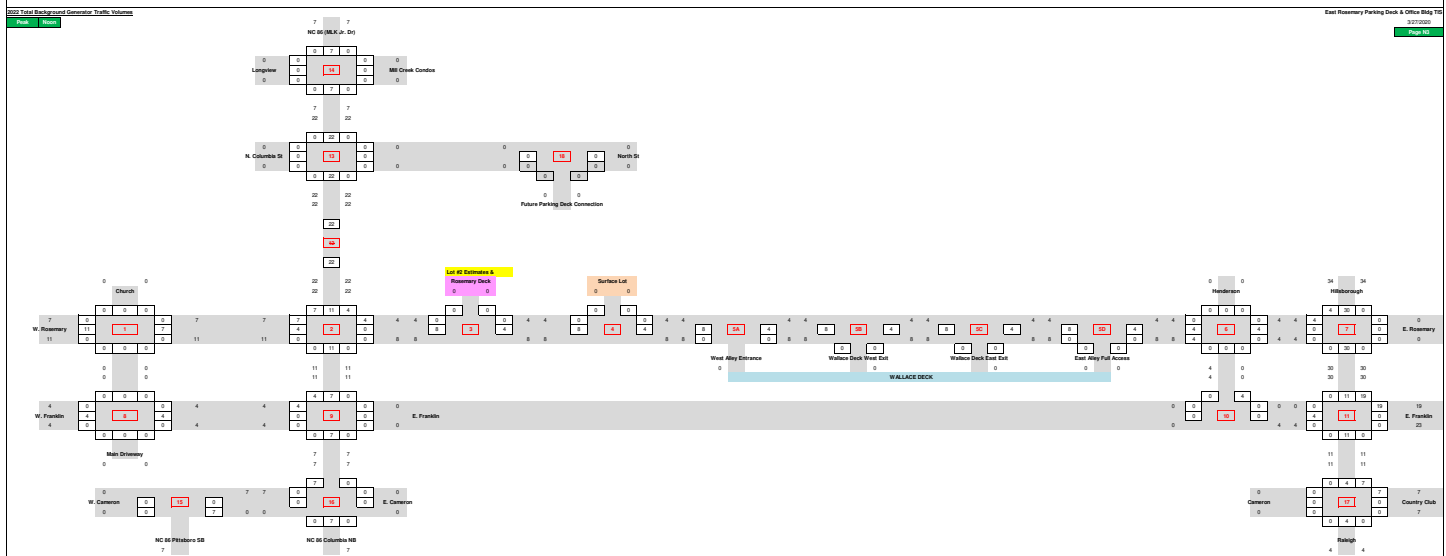
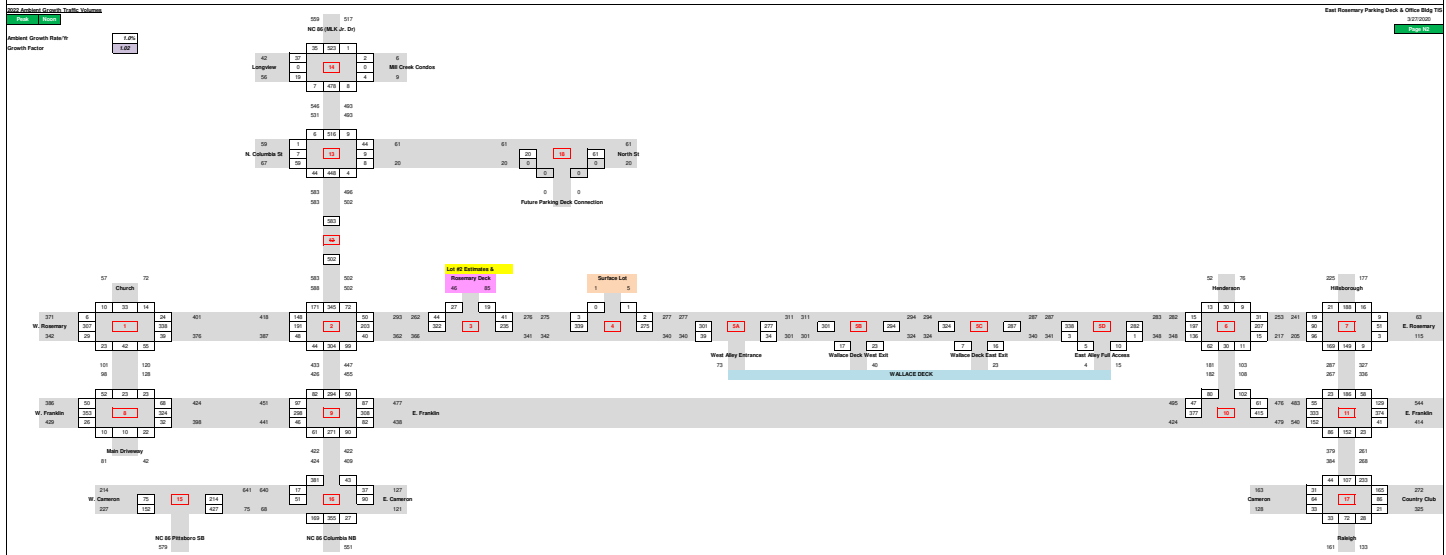
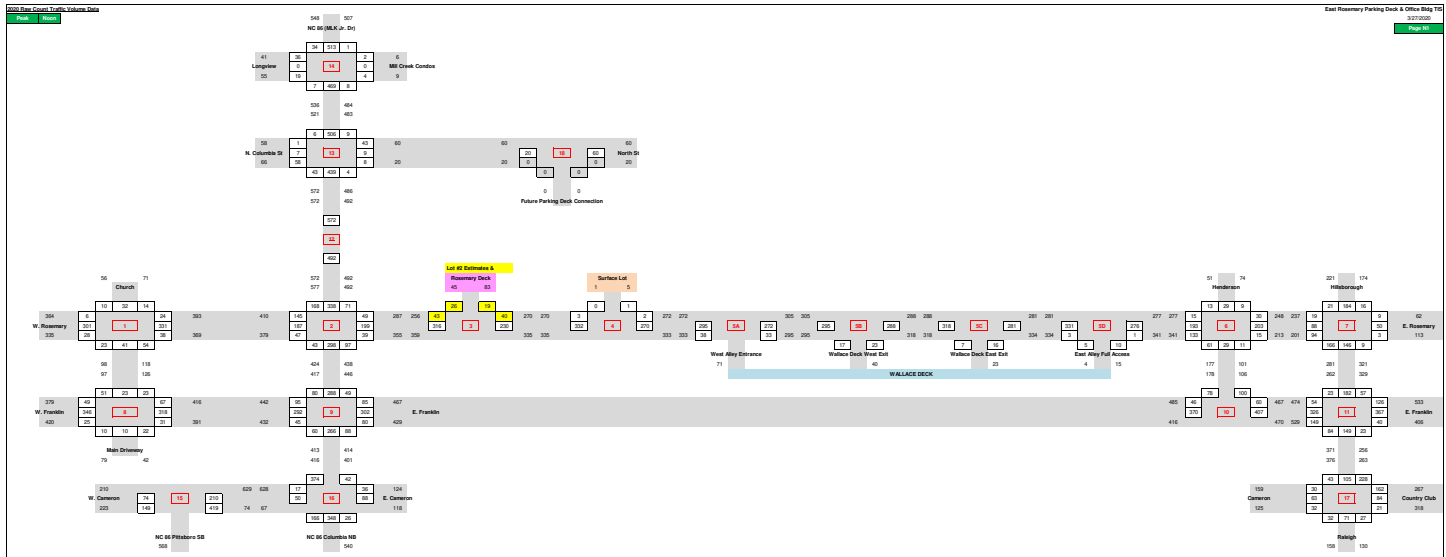

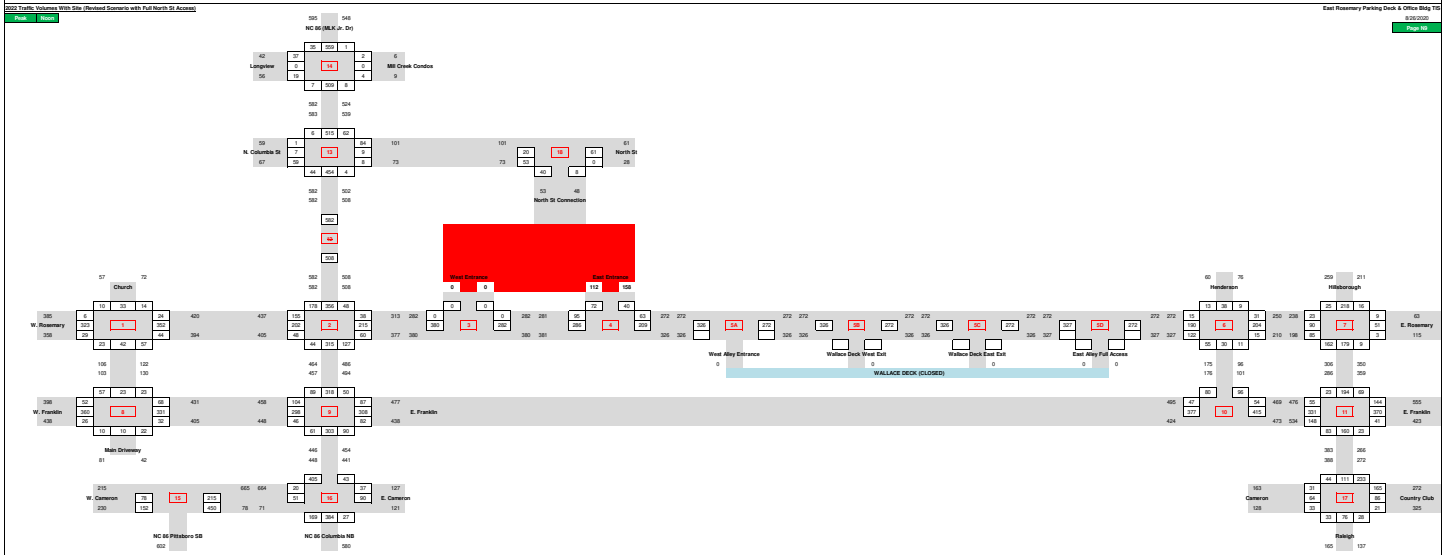
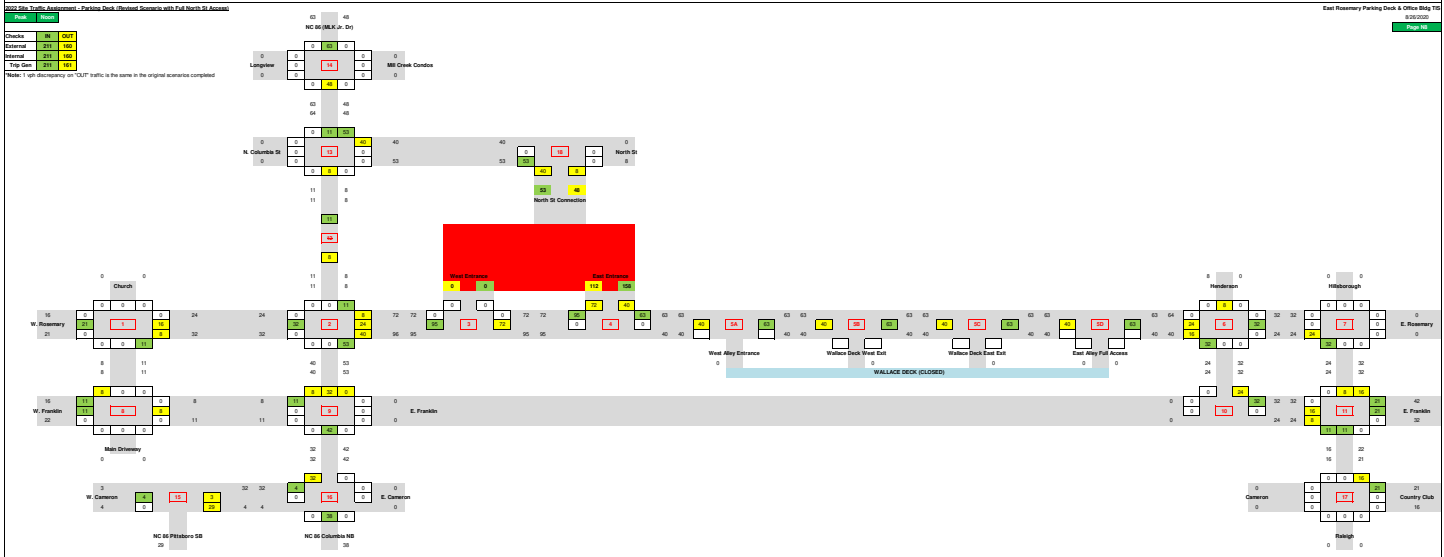
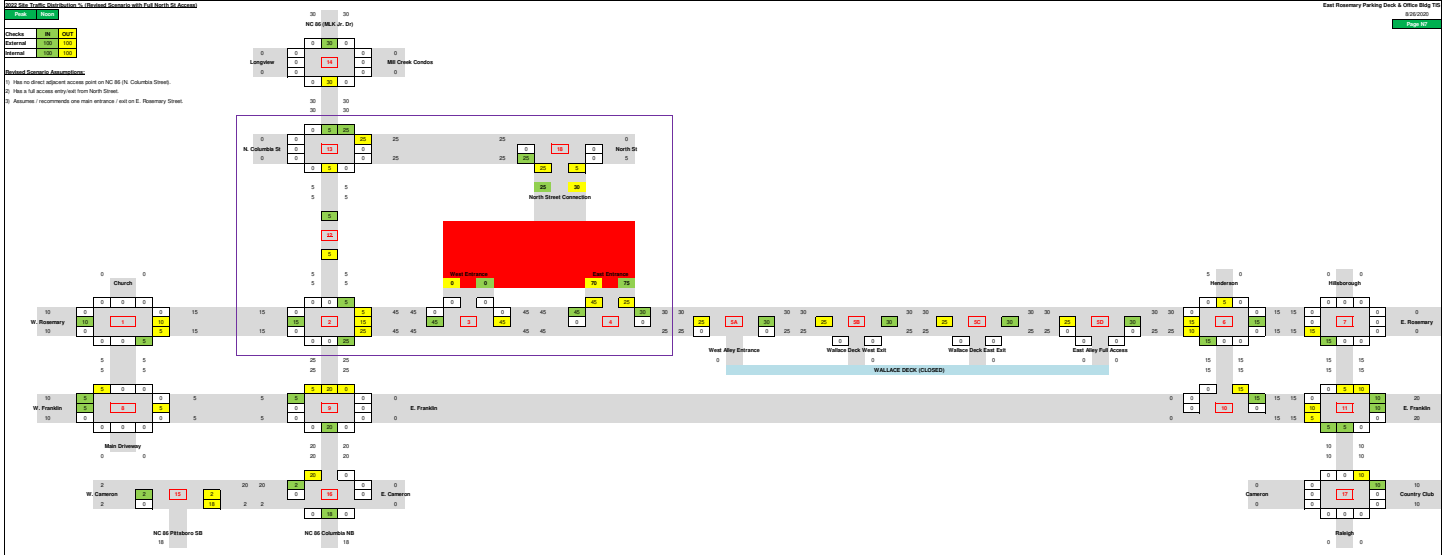
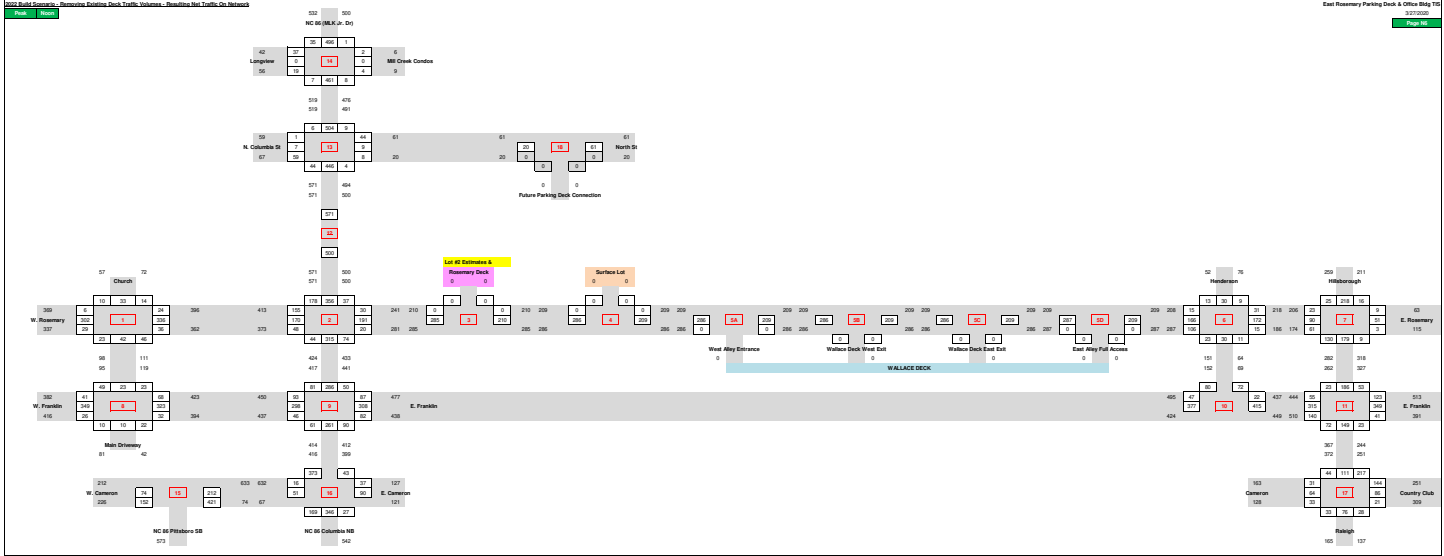
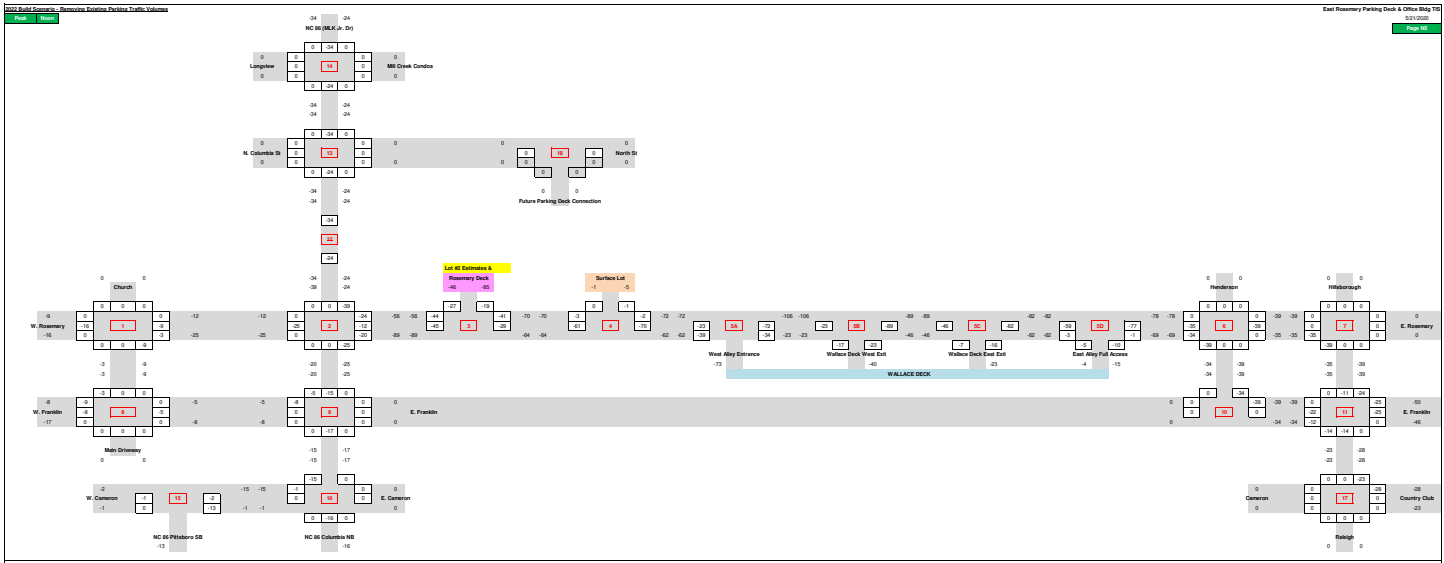

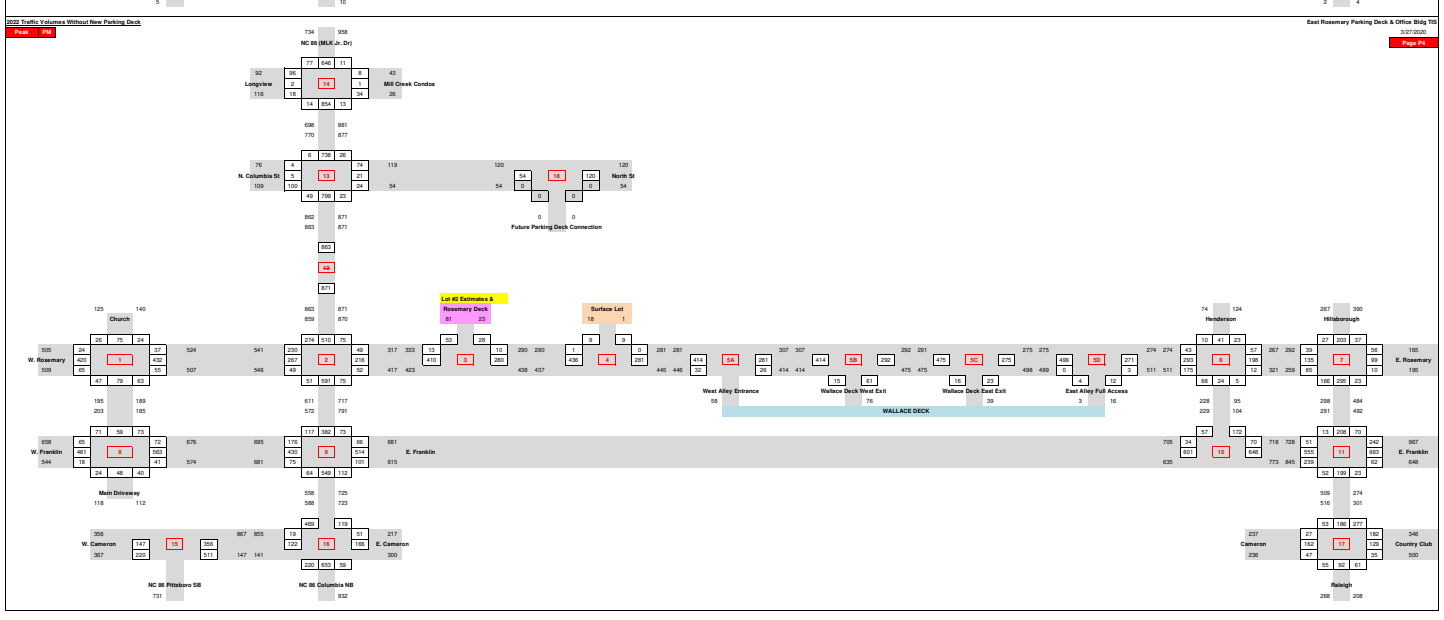
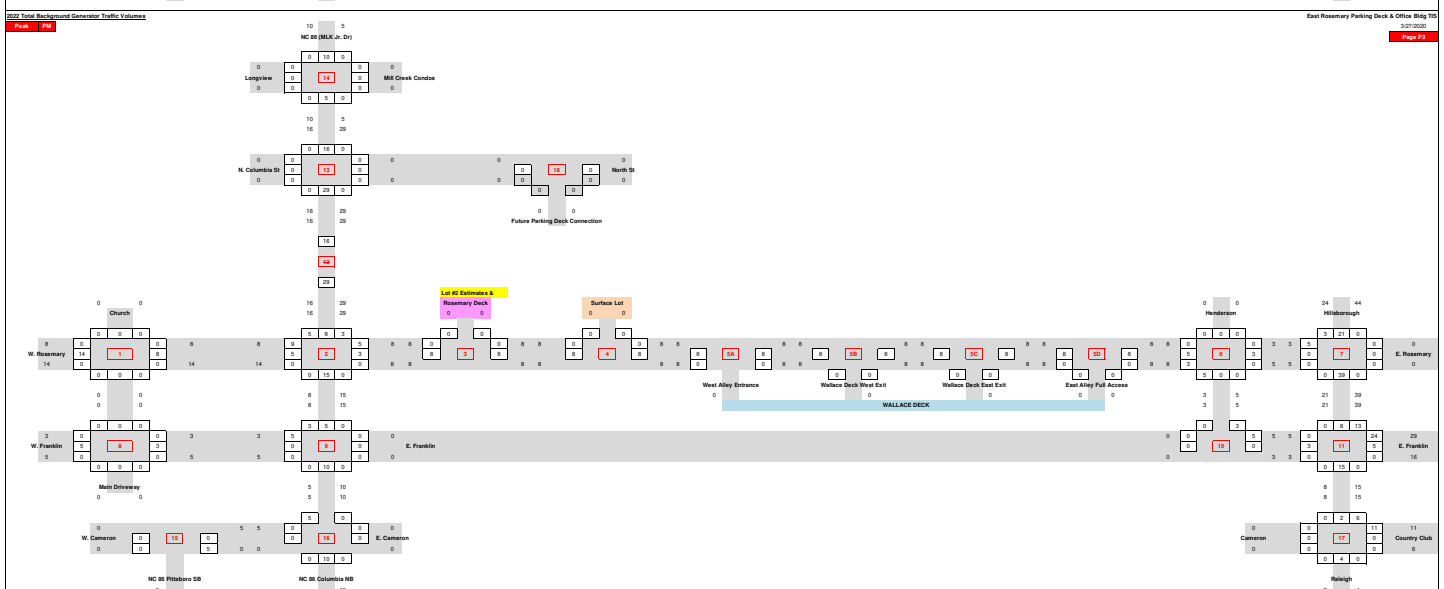
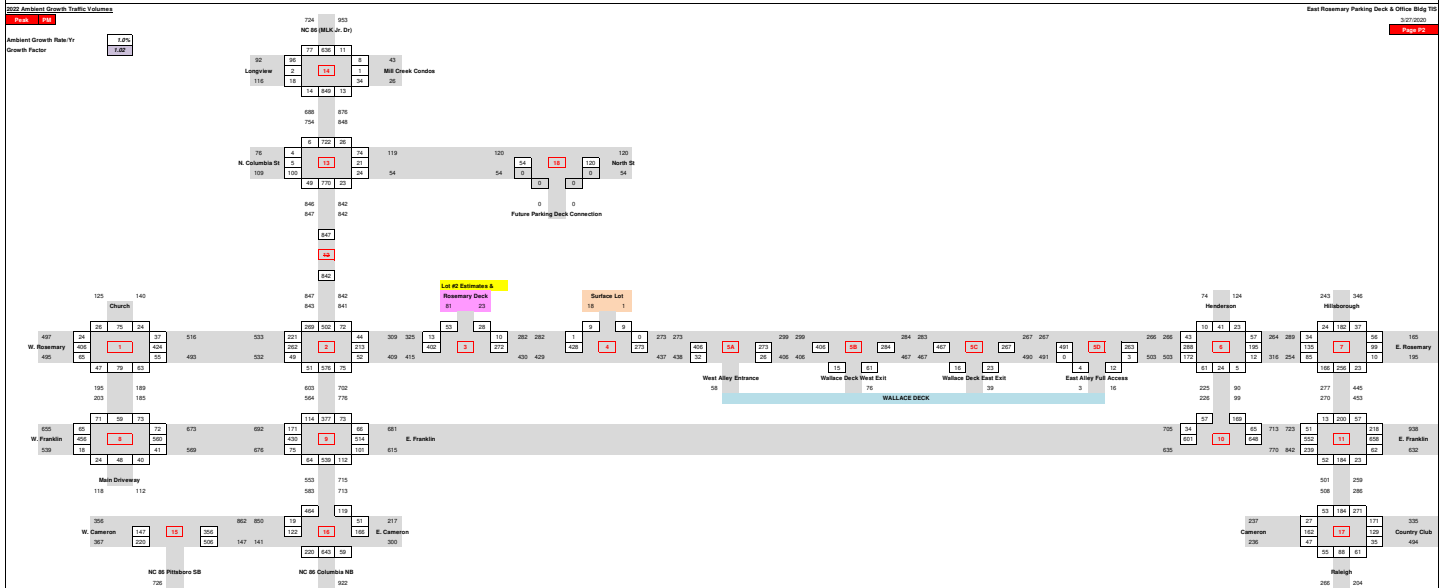
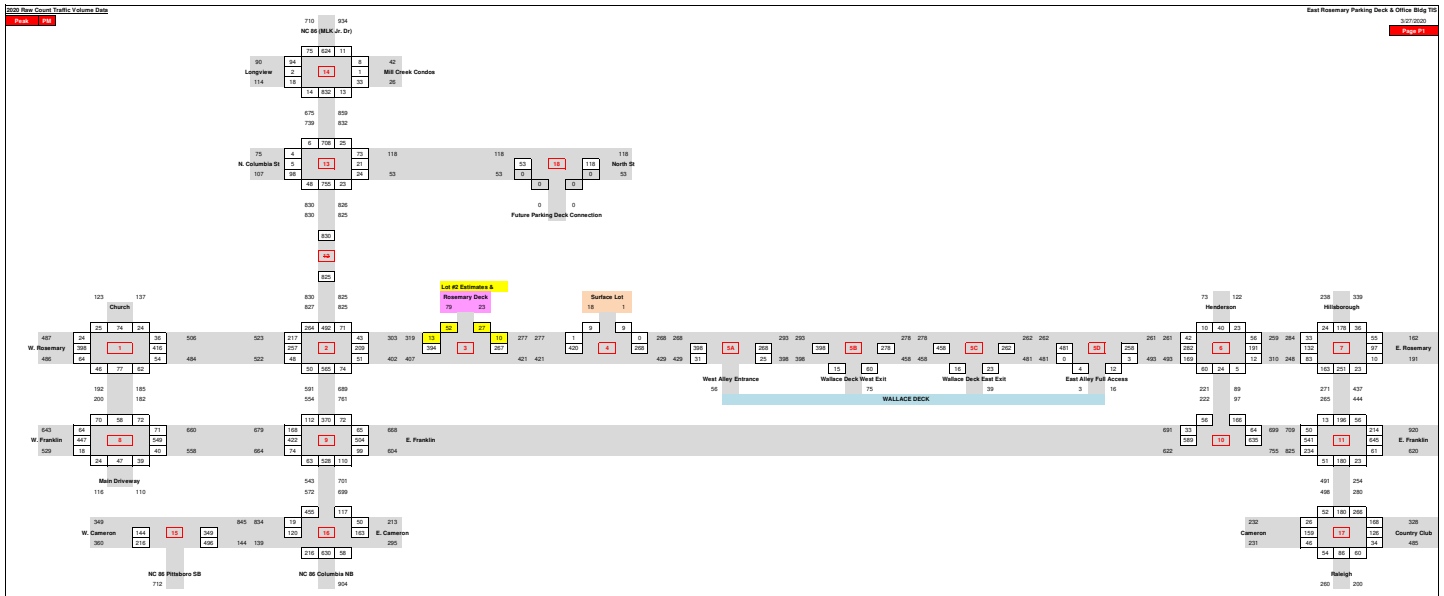

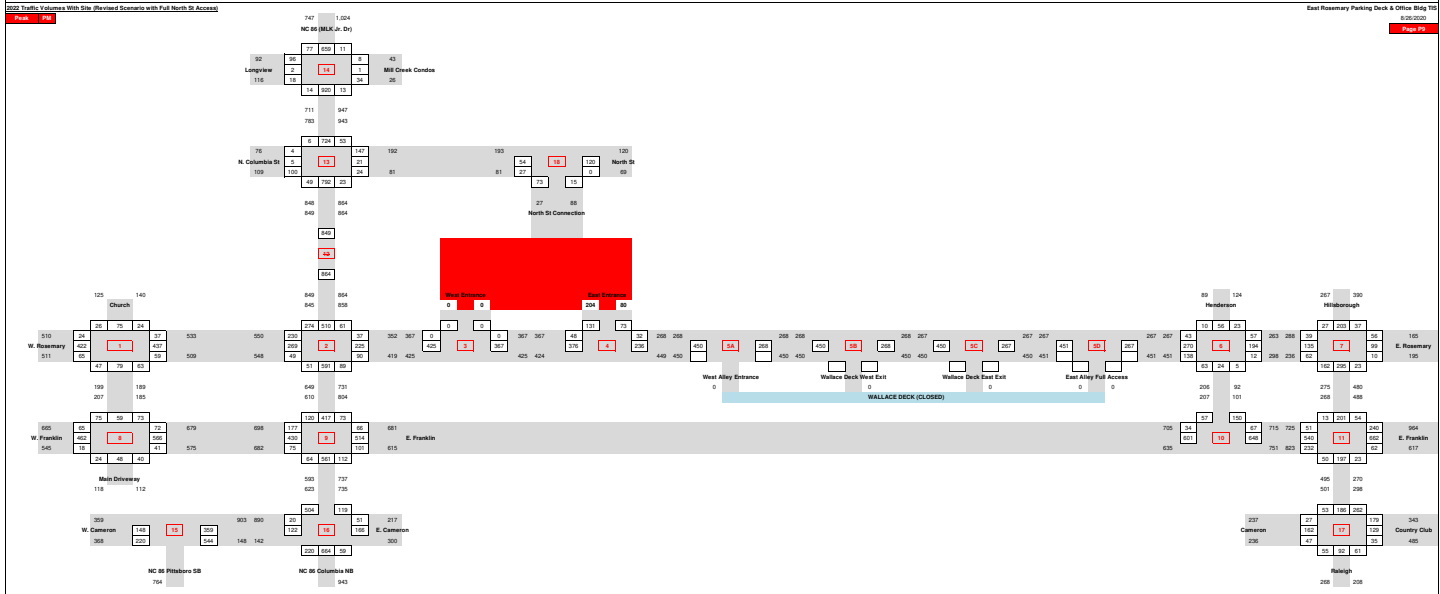
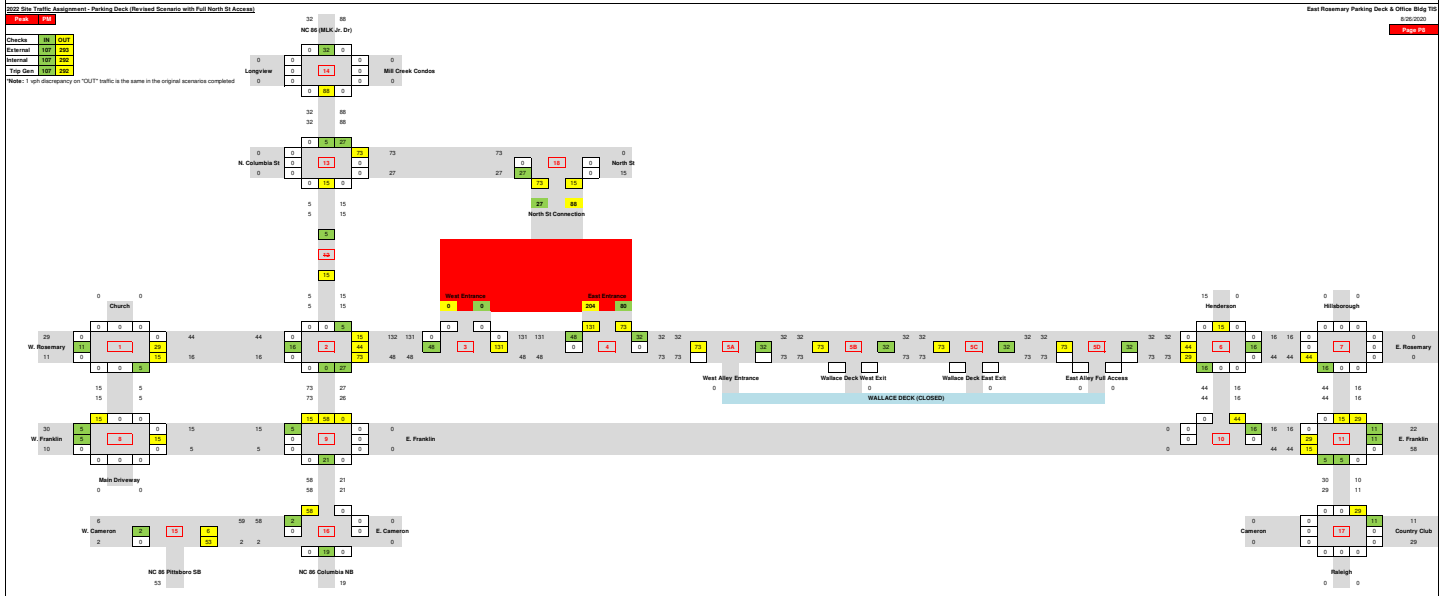
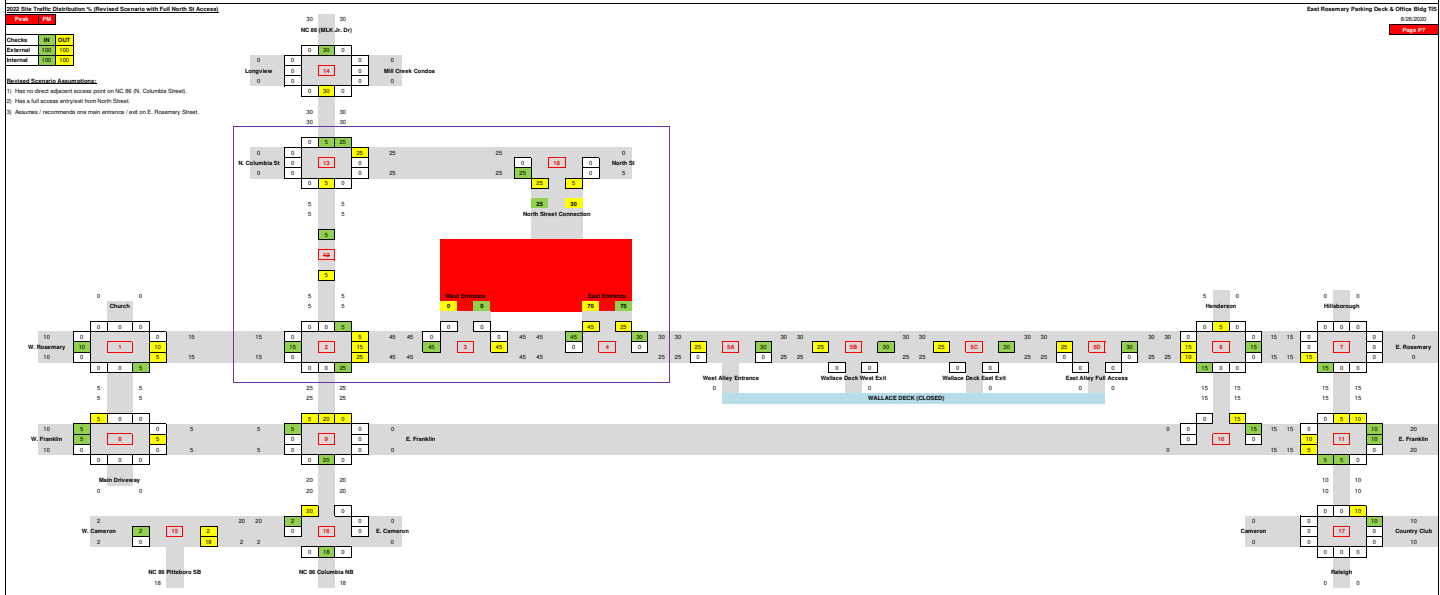
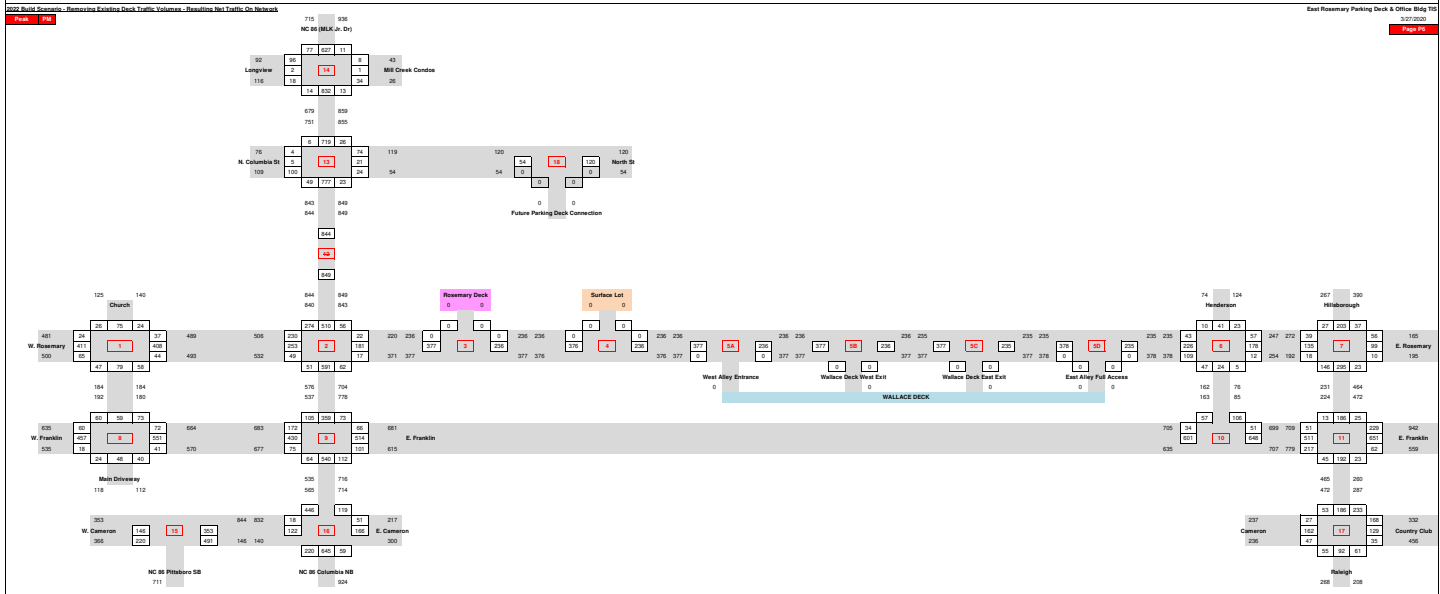
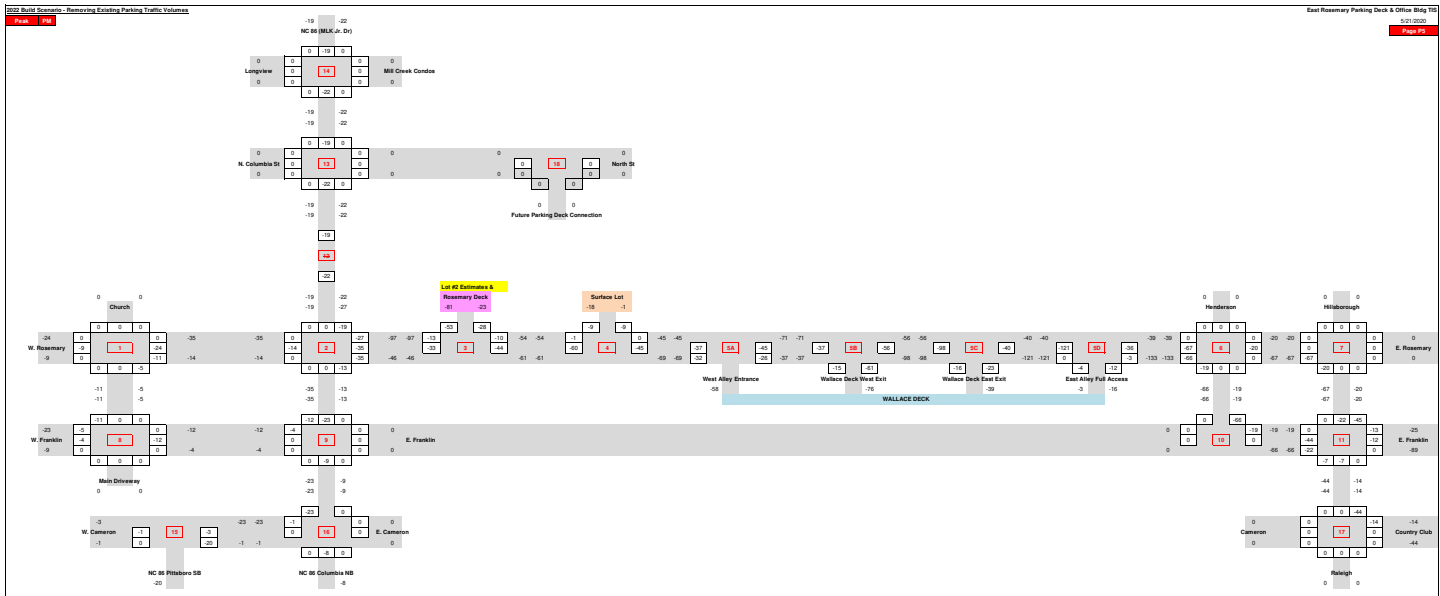

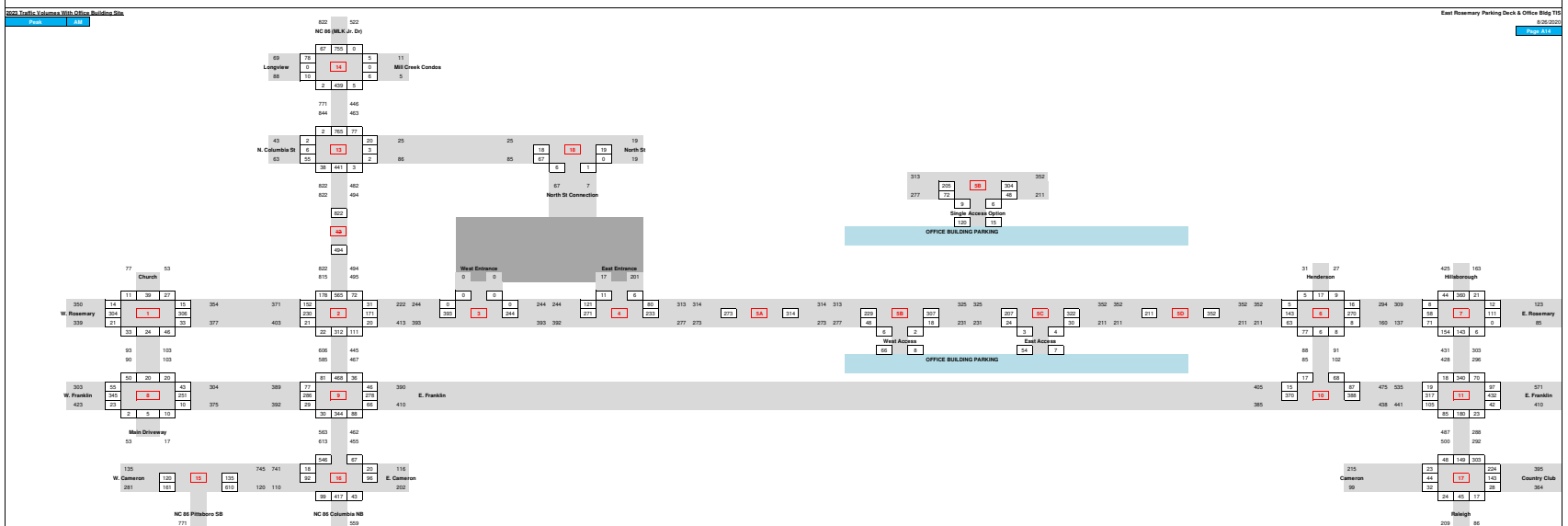
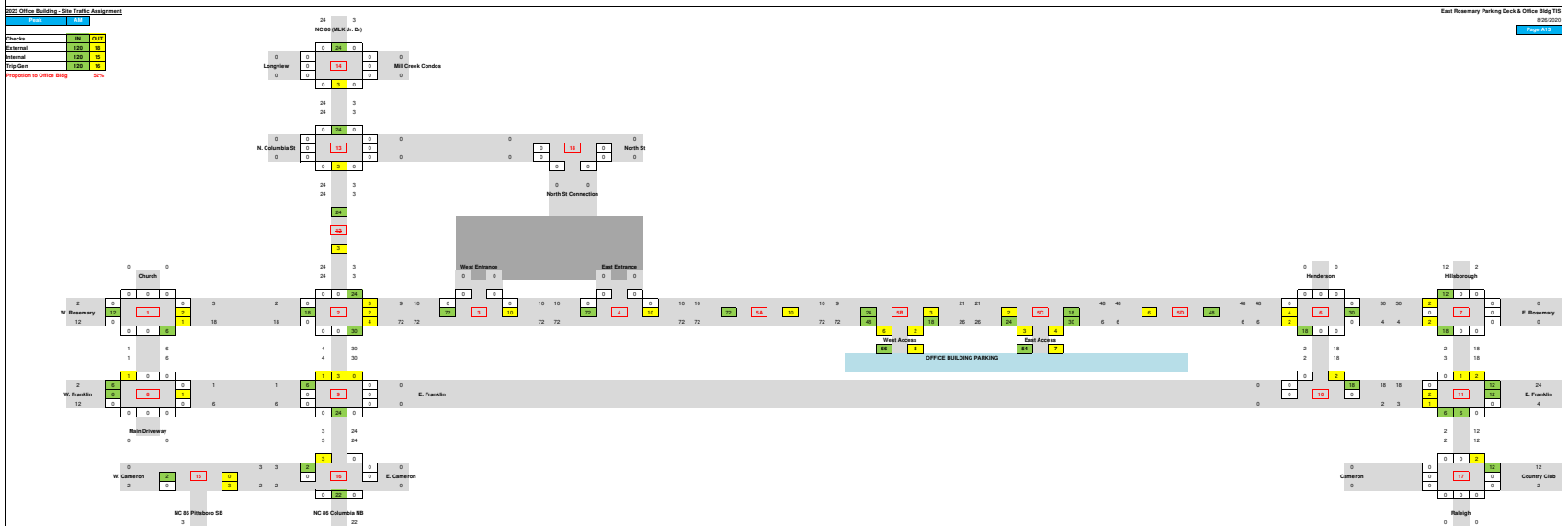
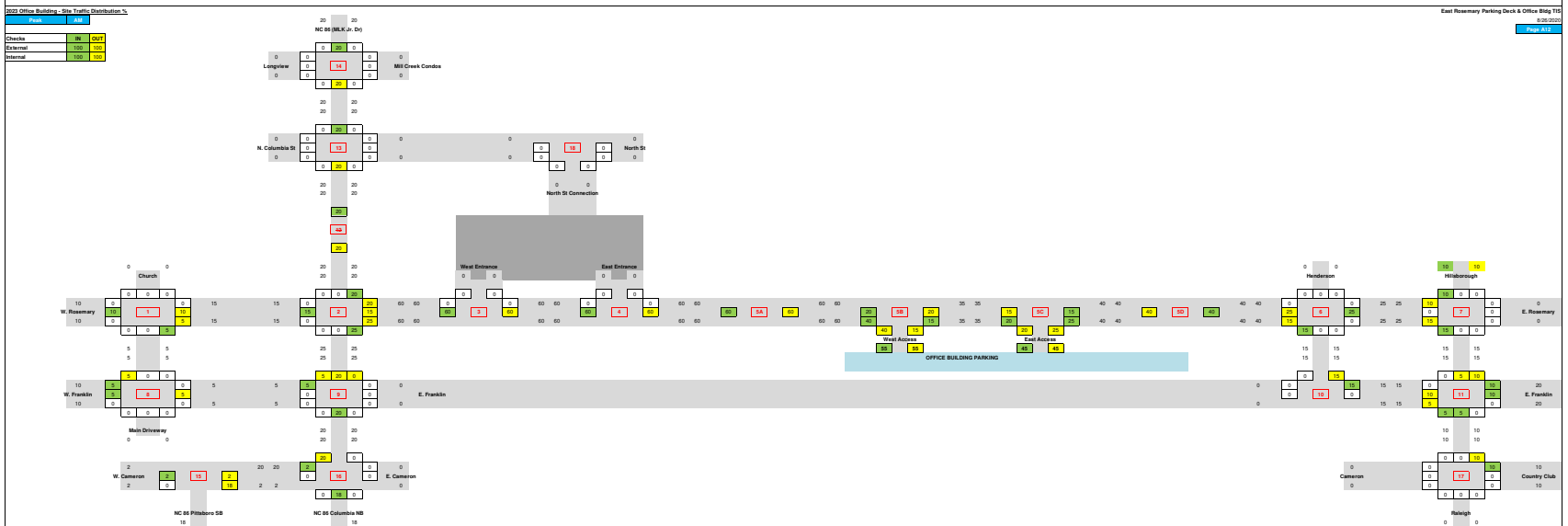
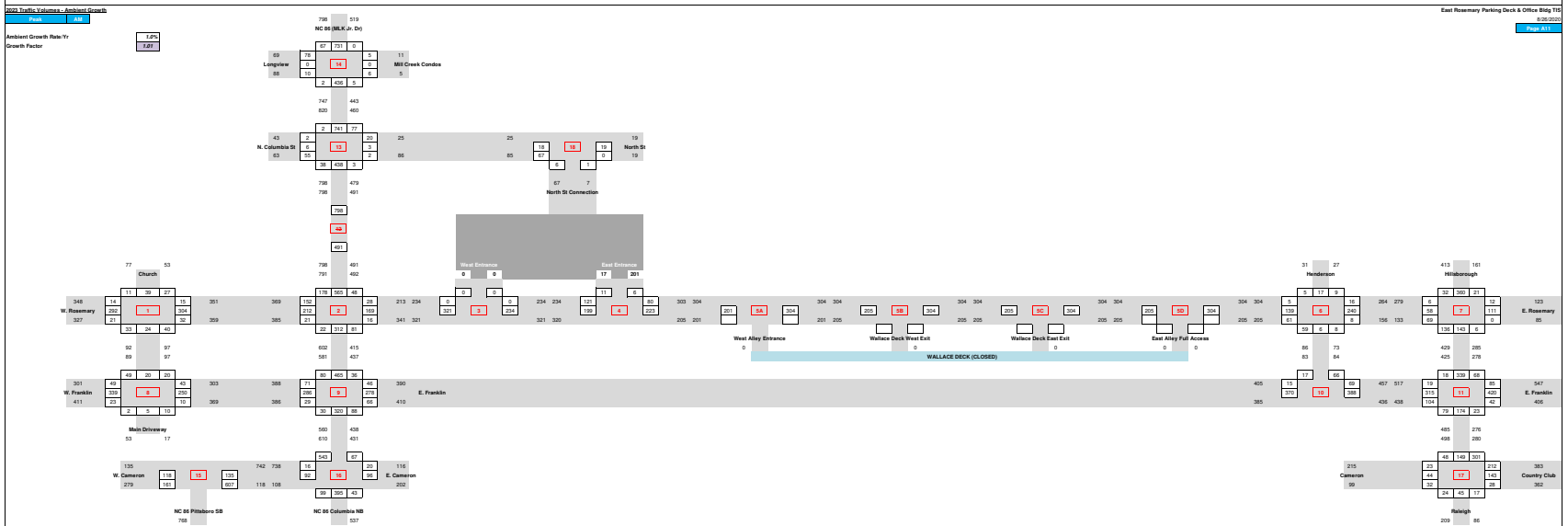
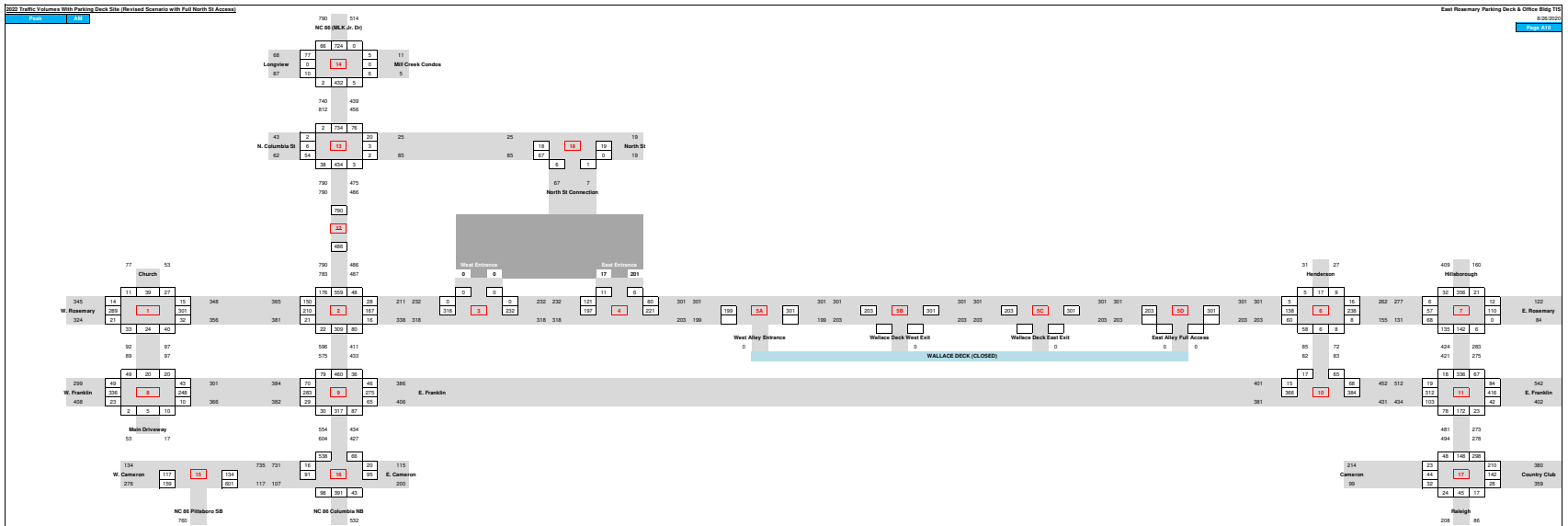

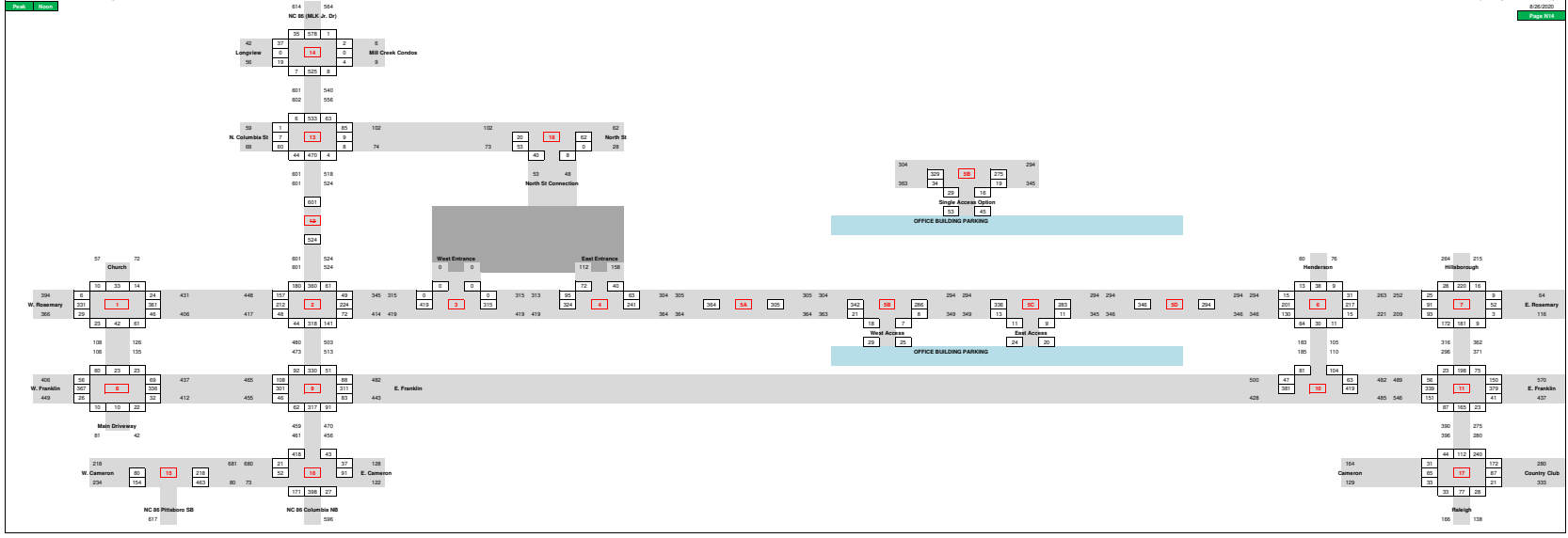
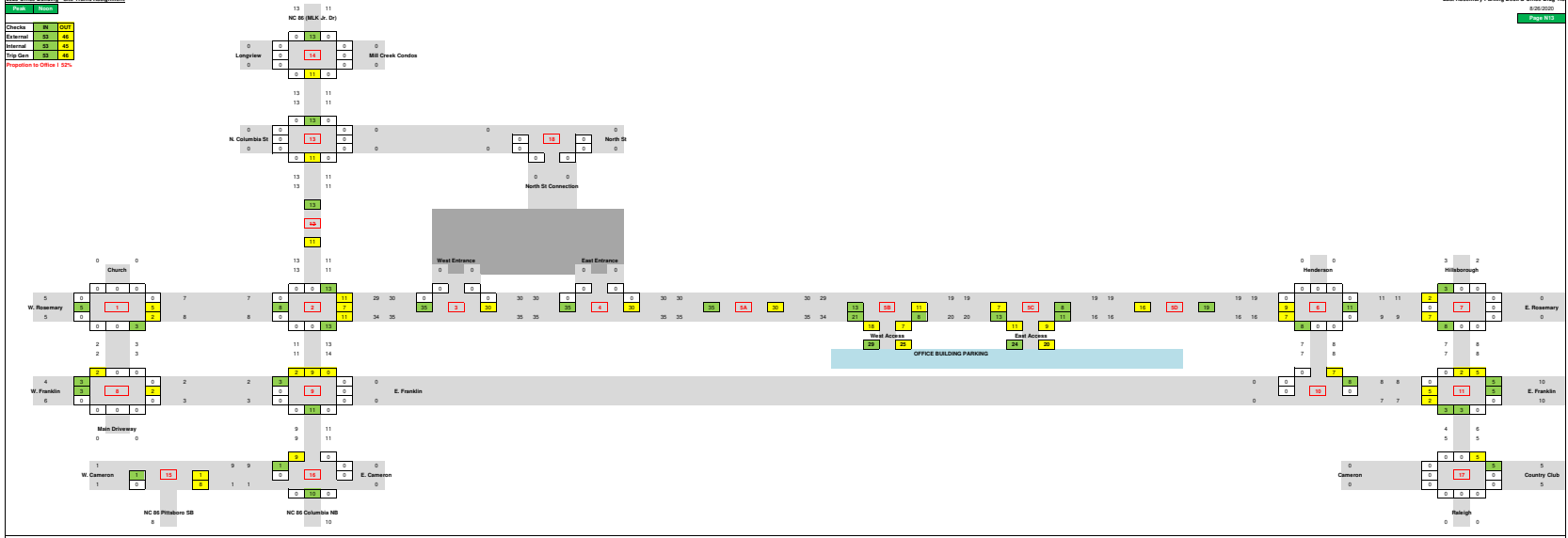
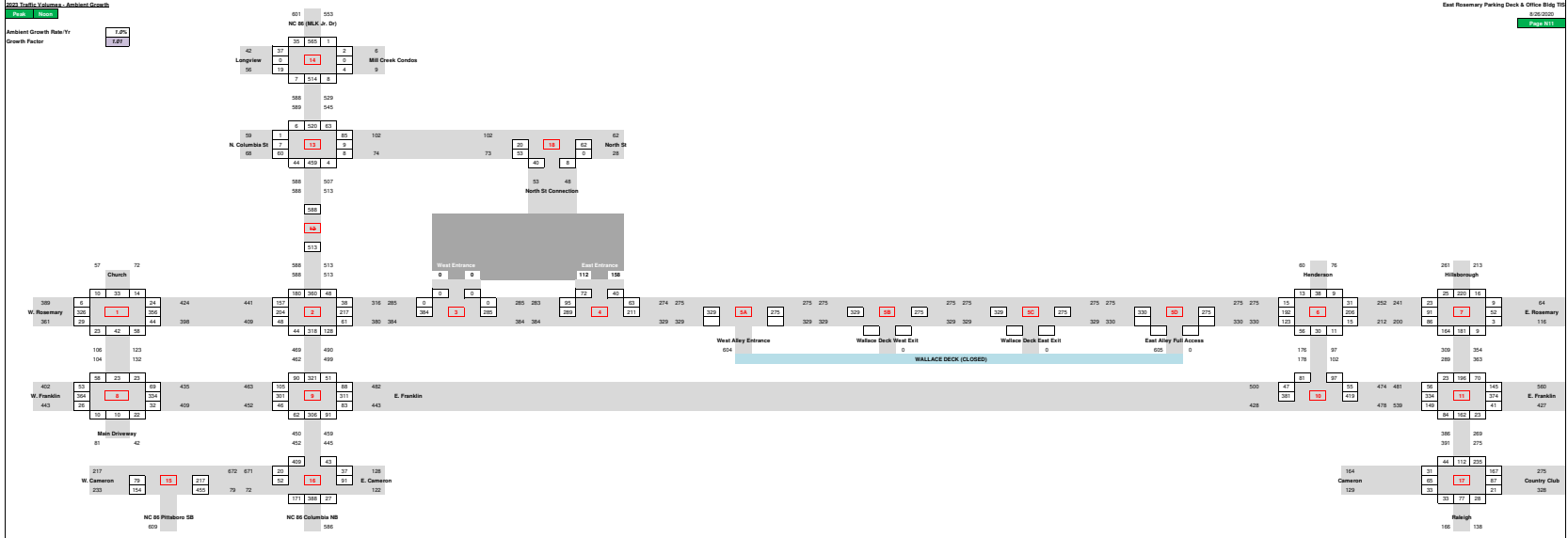
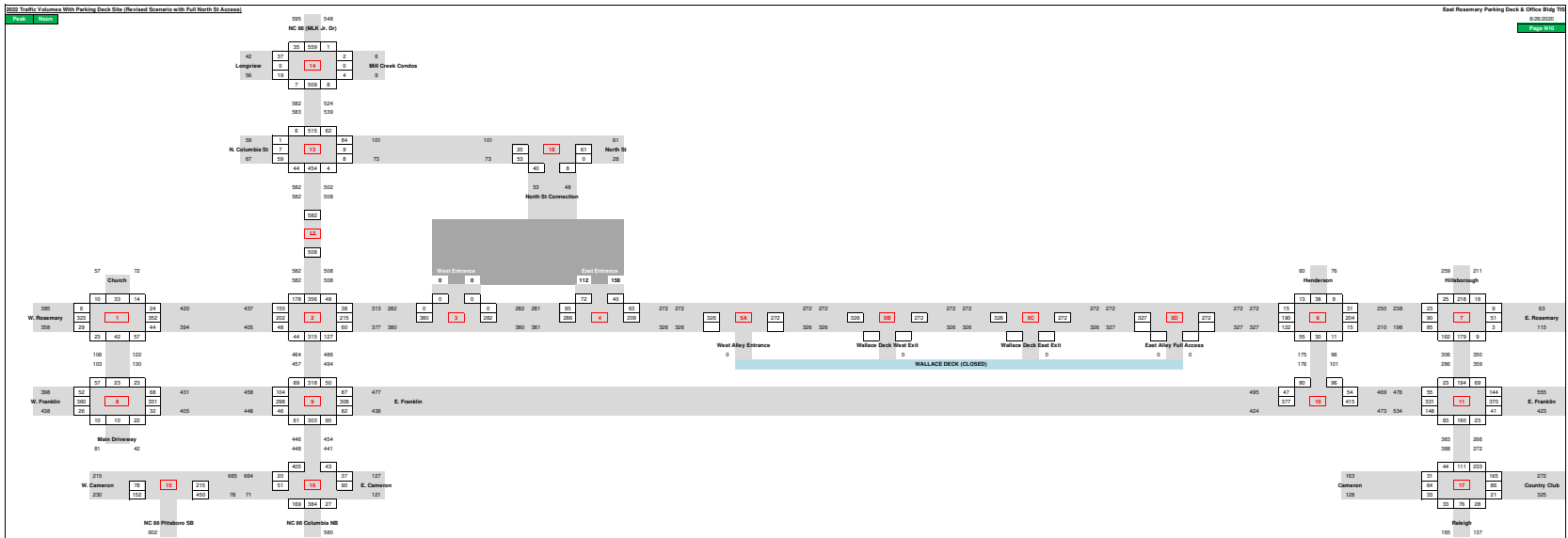

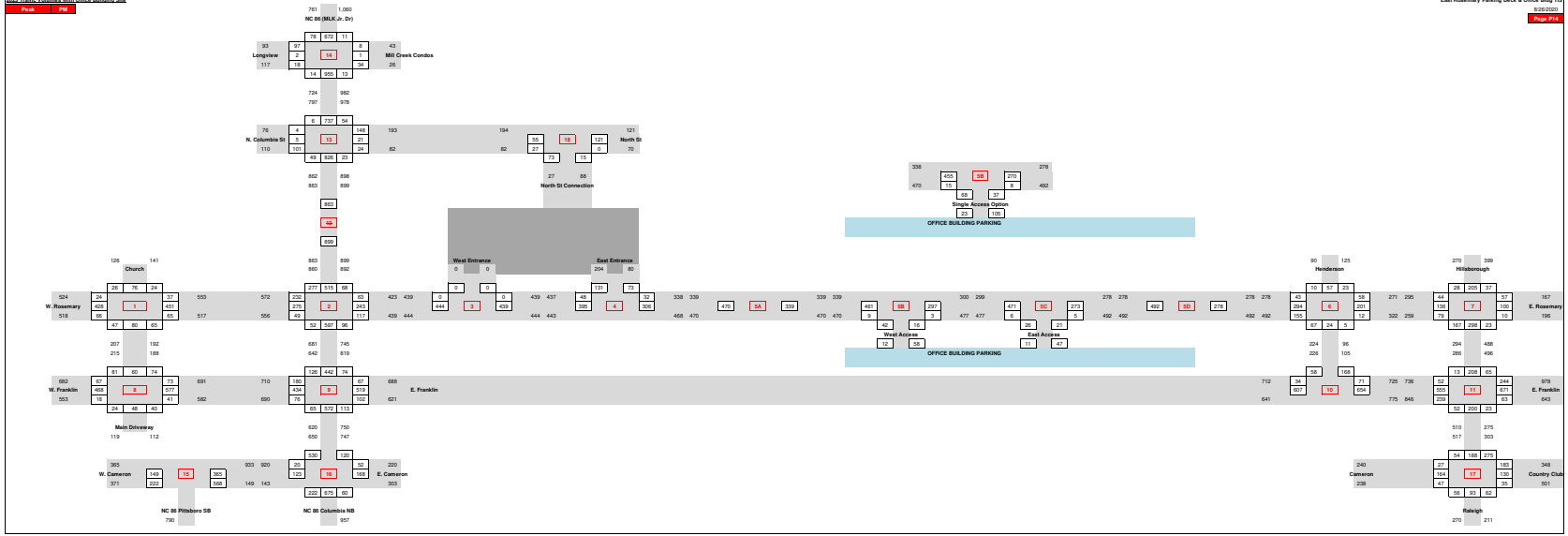
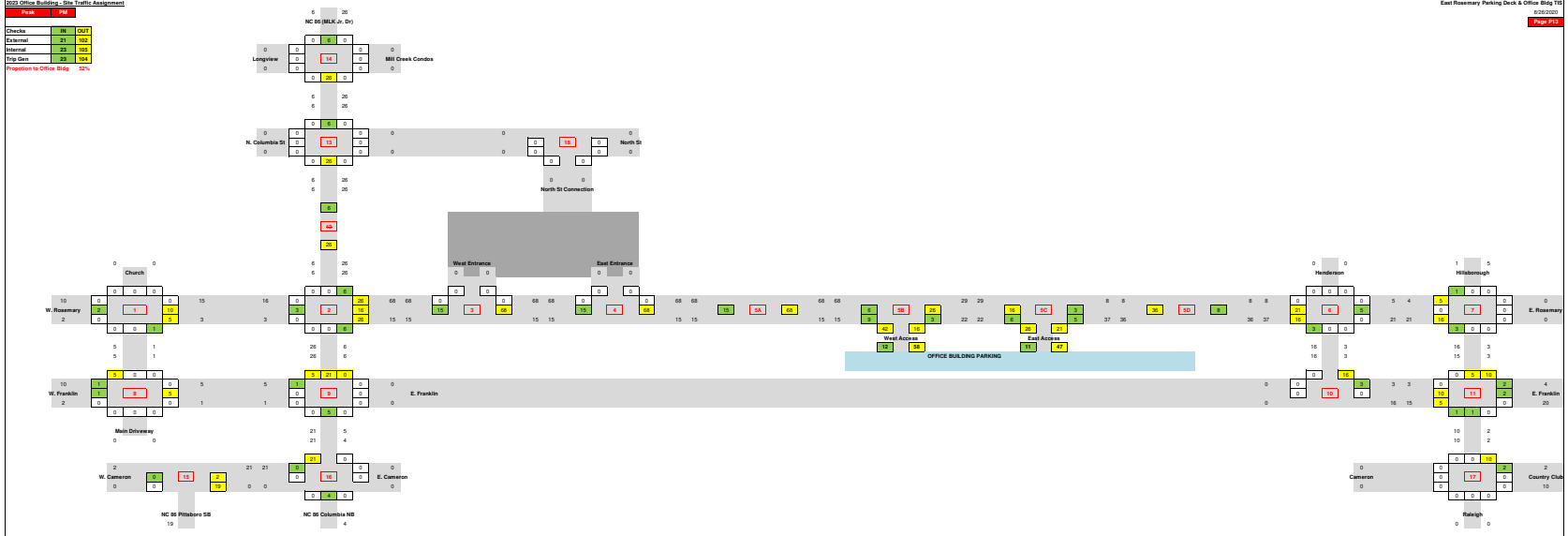
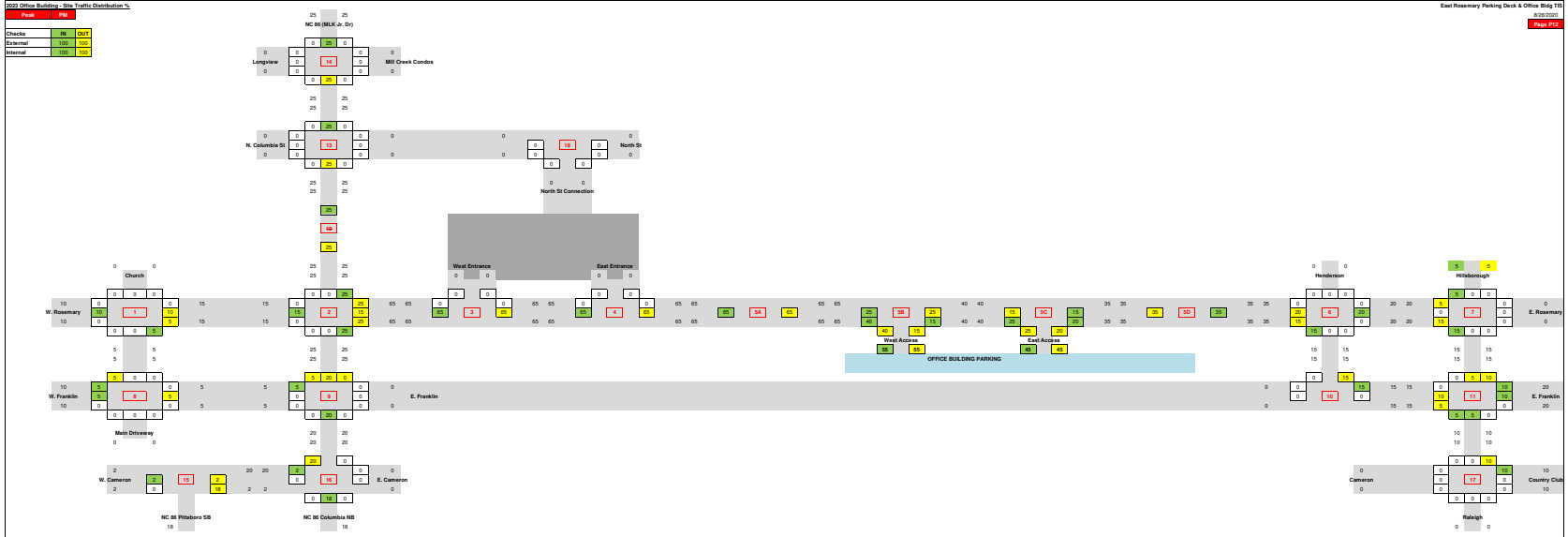
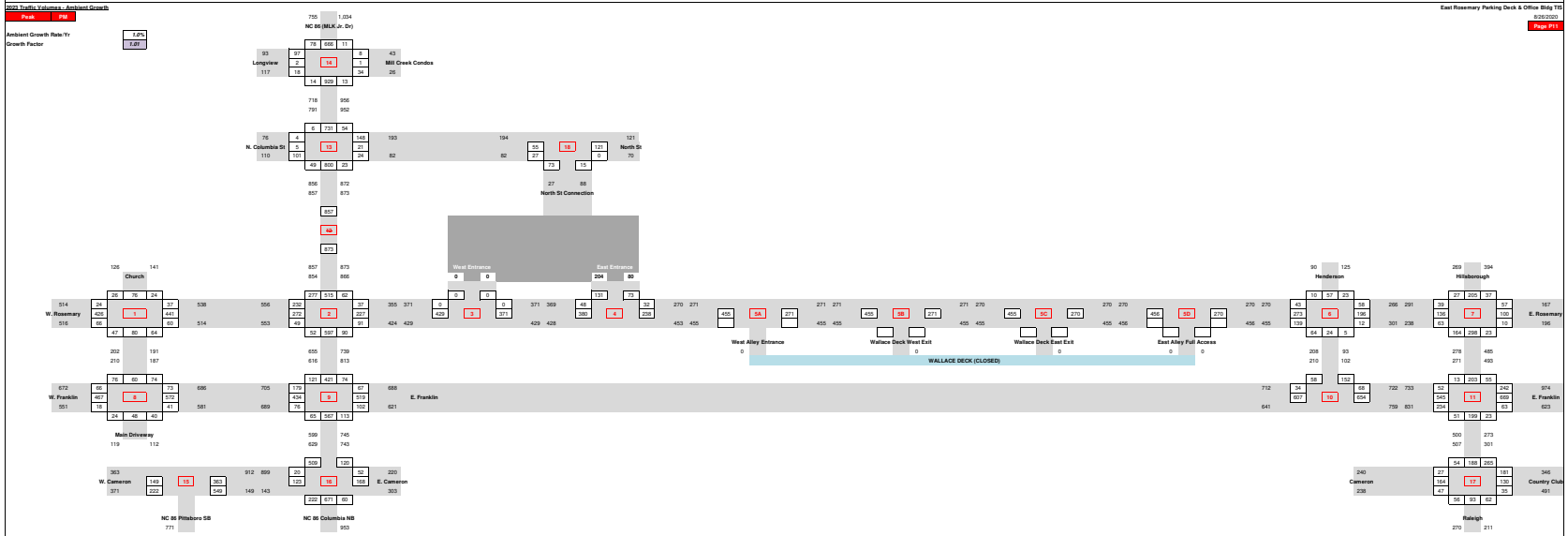
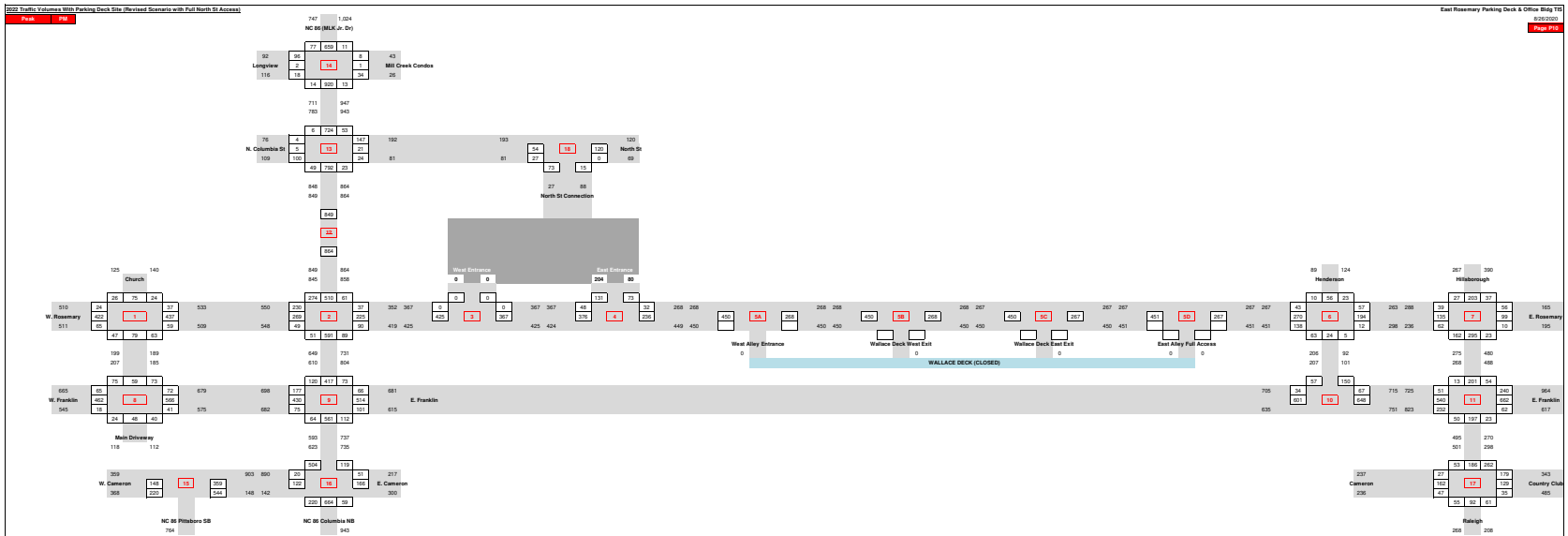



Appendix D – Synchro Signalized Capacity Analysis Output

2020 Existing Base Year

Lanes, Volumes, Timings
1: Church Street & W. Rosemary Street

2020 Existing AM Peak
Timing Plan: AM Peak



Lane Group	EBL	EBT	EBR	WBL	WBT	WBR	NBL	NBT	NBR	SBL	SBT	SBR
Lane Configurations		↕			↕			↕			↕	
Traffic Volume (vph)	14	278	21	31	283	15	32	24	35	26	38	11
Future Volume (vph)	14	278	21	31	283	15	32	24	35	26	38	11
Ideal Flow (vphpl)	1900	1900	1900	1900	1900	1900	1900	1900	1900	1900	1900	1900
Lane Width (ft)	12	14	12	12	14	12	12	12	12	12	12	12
Grade (%)		1%			-1%			0%			0%	
Lane Util. Factor	1.00	1.00	1.00	1.00	1.00	1.00	1.00	1.00	1.00	1.00	1.00	1.00
Ped Bike Factor		0.99			0.99			0.95			0.97	
Frt		0.991			0.994			0.948			0.981	
Flt Protected		0.998			0.995			0.983			0.983	
Satd. Flow (prot)	0	1734	0	0	1737	0	0	1511	0	0	1602	0
Flt Permitted		0.982			0.950			0.882			0.881	
Satd. Flow (perm)	0	1704	0	0	1654	0	0	1338	0	0	1408	0
Right Turn on Red			No			No			No			No
Satd. Flow (RTOR)												
Link Speed (mph)		20			20			25			25	
Link Distance (ft)		964			757			379			430	
Travel Time (s)		32.9			25.8			10.3			11.7	
Confl. Peds. (#/hr)	20		17	17		20	21		31	31		21
Peak Hour Factor	0.86	0.86	0.86	0.89	0.89	0.89	0.84	0.84	0.84	0.72	0.72	0.72
Heavy Vehicles (%)	3%	3%	3%	4%	4%	4%	2%	2%	2%	2%	2%	2%
Adj. Flow (vph)	16	323	24	35	318	17	38	29	42	36	53	15
Shared Lane Traffic (%)												
Lane Group Flow (vph)	0	363	0	0	370	0	0	109	0	0	104	0
Turn Type	Perm	NA		Perm	NA		Perm	NA		Perm	NA	
Protected Phases		2			6			8			4	
Permitted Phases	2			6			8			4		
Detector Phase	2	2		6	6		8	8		4	4	
Switch Phase												
Minimum Initial (s)	10.0	10.0		10.0	10.0		7.0	7.0		7.0	7.0	
Minimum Split (s)	19.0	19.0		20.0	20.0		19.0	19.0		19.0	19.0	
Total Split (s)	40.0	40.0		40.0	40.0		20.0	20.0		20.0	20.0	
Total Split (%)	66.7%	66.7%		66.7%	66.7%		33.3%	33.3%		33.3%	33.3%	
Maximum Green (s)	35.5	35.5		35.4	35.4		15.1	15.1		15.1	15.1	
Yellow Time (s)	3.1	3.1		3.1	3.1		3.2	3.2		3.2	3.2	
All-Red Time (s)	1.4	1.4		1.5	1.5		1.7	1.7		1.7	1.7	
Lost Time Adjust (s)		0.5			0.4			0.1			0.1	
Total Lost Time (s)		5.0			5.0			5.0			5.0	
Lead/Lag												
Lead-Lag Optimize?												
Vehicle Extension (s)	3.0	3.0		3.0	3.0		3.0	3.0		3.0	3.0	
Recall Mode	C-Max	C-Max		C-Max	C-Max		None	None		None	None	
Walk Time (s)	4.0	4.0		4.0	4.0		4.0	4.0		4.0	4.0	
Flash Dont Walk (s)	5.0	5.0		6.0	6.0		10.0	10.0		10.0	10.0	
Pedestrian Calls (#/hr)	0	0		0	0		0	0		0	0	
Act Effct Green (s)		43.0			43.0			10.4			10.4	
Actuated g/C Ratio		0.72			0.72			0.17			0.17	
v/c Ratio		0.30			0.31			0.47			0.43	
Control Delay		5.6			8.4			25.9			26.8	

Lanes, Volumes, Timings
 1: Church Street & W. Rosemary Street

2020 Existing AM Peak
 Timing Plan: AM Peak



Lane Group	EBL	EBT	EBR	WBL	WBT	WBR	NBL	NBT	NBR	SBL	SBT	SBR
Queue Delay		0.0			0.0			0.0			0.0	
Total Delay		5.6			8.4			25.9			26.8	
LOS		A			A			C			C	
Approach Delay		5.6			8.4			25.9			26.8	
Approach LOS		A			A			C			C	
Queue Length 50th (ft)		45			142			34			34	
Queue Length 95th (ft)		97			186			69			52	
Internal Link Dist (ft)		884			677			299			350	
Turn Bay Length (ft)												
Base Capacity (vph)		1222			1185			334			352	
Starvation Cap Reductn		0			0			0			0	
Spillback Cap Reductn		0			0			0			0	
Storage Cap Reductn		0			0			0			0	
Reduced v/c Ratio		0.30			0.31			0.33			0.30	

Intersection Summary

Area Type:	CBD
Cycle Length:	60
Actuated Cycle Length:	60
Offset:	23 (38%), Referenced to phase 2:EBTL and 6:WBTL, Start of Green
Natural Cycle:	40
Control Type:	Actuated-Coordinated
Maximum v/c Ratio:	0.47
Intersection Signal Delay:	11.3
Intersection LOS:	B
Intersection Capacity Utilization:	49.6%
ICU Level of Service:	A
Analysis Period (min):	15

Splits and Phases: 1: Church Street & W. Rosemary Street



Lanes, Volumes, Timings
 2: NC 86 (N. Columbia St) & W. Rosemary Street/E. Rosemary Street

2020 Existing AM Peak
 Timing Plan: AM Peak



Lane Group	EBL	EBT	EBR	WBL	WBT	WBR	NBL	NBT	NBR	SBL	SBT	SBR
Lane Configurations												
Traffic Volume (vph)	145	197	21	11	160	30	22	299	33	71	533	164
Future Volume (vph)	145	197	21	11	160	30	22	299	33	71	533	164
Ideal Flow (vphpl)	1900	1900	1900	1900	1900	1900	1900	1900	1900	1900	1900	1900
Lane Width (ft)	9	12	13	12	12	12	9	10	12	12	9	11
Grade (%)		1%			1%			-2%			8%	
Storage Length (ft)	100		0	150		0	75		0	150		400
Storage Lanes	1		0	1		0	1		0	1		1
Taper Length (ft)	25			25			25			25		
Lane Util. Factor	1.00	1.00	1.00	1.00	1.00	1.00	1.00	0.95	0.95	1.00	0.95	1.00
Ped Bike Factor	0.99	1.00		0.98	1.00		0.98	0.99		0.93		0.91
Frt		0.986			0.977			0.985				0.850
Flt Protected	0.950			0.950			0.950			0.950		
Satd. Flow (prot)	1426	1639	0	1585	1623	0	1355	2730	0	1485	2673	1285
Flt Permitted	0.291			0.602			0.374			0.502		
Satd. Flow (perm)	433	1639	0	988	1623	0	523	2730	0	731	2673	1169
Right Turn on Red			No			No			No			No
Satd. Flow (RTOR)												
Link Speed (mph)		20			20			25			25	
Link Distance (ft)		757			339			353			476	
Travel Time (s)		25.8			11.6			9.6			13.0	
Confl. Peds. (#/hr)	12		16	16		12	19		34	34		19
Peak Hour Factor	0.86	0.86	0.86	0.90	0.90	0.90	0.90	0.90	0.90	0.88	0.88	0.88
Heavy Vehicles (%)	2%	2%	2%	2%	2%	2%	9%	9%	9%	5%	5%	5%
Adj. Flow (vph)	169	229	24	12	178	33	24	332	37	81	606	186
Shared Lane Traffic (%)												
Lane Group Flow (vph)	169	253	0	12	211	0	24	369	0	81	606	186
Turn Type	pm+pt	NA		Perm	NA		pm+pt	NA		pm+pt	NA	pm+ov
Protected Phases	7	4			8		5	2		1	6	7
Permitted Phases	4			8			2			6		6
Detector Phase	7	4		8	8		5	2		1	6	7
Switch Phase												
Minimum Initial (s)	7.0	7.0		7.0	7.0		7.0	10.0		7.0	10.0	7.0
Minimum Split (s)	13.0	31.0		32.0	32.0		13.0	23.0		13.0	22.0	13.0
Total Split (s)	21.0	53.0		32.0	32.0		15.0	54.0		13.0	52.0	21.0
Total Split (%)	17.5%	44.2%		26.7%	26.7%		12.5%	45.0%		10.8%	43.3%	17.5%
Maximum Green (s)	15.2	47.0		26.0	26.0		9.2	48.2		7.9	46.2	15.2
Yellow Time (s)	3.0	3.2		3.2	3.2		3.0	3.3		3.0	3.3	3.0
All-Red Time (s)	2.8	2.8		2.8	2.8		2.8	2.5		2.1	2.5	2.8
Lost Time Adjust (s)	-0.8	-1.0		-1.0	-1.0		-1.0	-0.8		-0.1	-0.8	-0.8
Total Lost Time (s)	5.0	5.0		5.0	5.0		4.8	5.0		5.0	5.0	5.0
Lead/Lag	Lead			Lag	Lag		Lead	Lag		Lead	Lag	Lead
Lead-Lag Optimize?							Yes	Yes		Yes	Yes	
Vehicle Extension (s)	1.0	1.0		1.0	1.0		1.0	3.0		1.0	3.0	1.0
Recall Mode	None	None		None	None		None	C-Max		None	C-Max	None
Walk Time (s)		7.0		7.0	7.0			7.0			7.0	
Flash Dont Walk (s)		18.0		19.0	19.0			10.0			9.0	
Pedestrian Calls (#/hr)		0		0	0			0			0	
Act Effect Green (s)	39.6	39.6		19.9	19.9		67.0	60.4		67.3	62.8	77.4

Lanes, Volumes, Timings
 2: NC 86 (N. Columbia St) & W. Rosemary Street/E. Rosemary Street

2020 Existing AM Peak
 Timing Plan: AM Peak



Lane Group	EBL	EBT	EBR	WBL	WBT	WBR	NBL	NBT	NBR	SBL	SBT	SBR
Actuated g/C Ratio	0.33	0.33		0.17	0.17		0.56	0.50		0.56	0.52	0.64
v/c Ratio	0.64	0.47		0.07	0.78		0.07	0.27		0.18	0.43	0.24
Control Delay	38.9	30.3		36.4	62.8		8.4	11.6		13.8	21.6	10.2
Queue Delay	0.0	0.0		0.0	0.0		0.0	0.0		0.0	0.0	0.0
Total Delay	38.9	30.3		36.4	62.8		8.4	11.6		13.8	21.6	10.2
LOS	D	C		D	E		A	B		B	C	B
Approach Delay		33.7			61.4			11.4			18.4	
Approach LOS		C			E			B			B	
Queue Length 50th (ft)	92	143		8	146		5	47		27	165	56
Queue Length 95th (ft)	133	177		m22	251		m10	65		57	237	105
Internal Link Dist (ft)		677			259			273			396	
Turn Bay Length (ft)	100			150			75			150		400
Base Capacity (vph)	275	655		222	365		370	1375		461	1397	782
Starvation Cap Reductn	0	0		0	0		0	0		0	0	0
Spillback Cap Reductn	0	0		0	0		0	0		0	49	0
Storage Cap Reductn	0	0		0	0		0	0		0	0	0
Reduced v/c Ratio	0.61	0.39		0.05	0.58		0.06	0.27		0.18	0.45	0.24

Intersection Summary

Area Type: CBD
 Cycle Length: 120
 Actuated Cycle Length: 120
 Offset: 84 (70%), Referenced to phase 2:NBTL and 6:SBTL, Start of Green
 Natural Cycle: 85
 Control Type: Actuated-Coordinated
 Maximum v/c Ratio: 0.78
 Intersection Signal Delay: 25.4 Intersection LOS: C
 Intersection Capacity Utilization 62.5% ICU Level of Service B
 Analysis Period (min) 15
 m Volume for 95th percentile queue is metered by upstream signal.

Splits and Phases: 2: NC 86 (N. Columbia St) & W. Rosemary Street/E. Rosemary Street

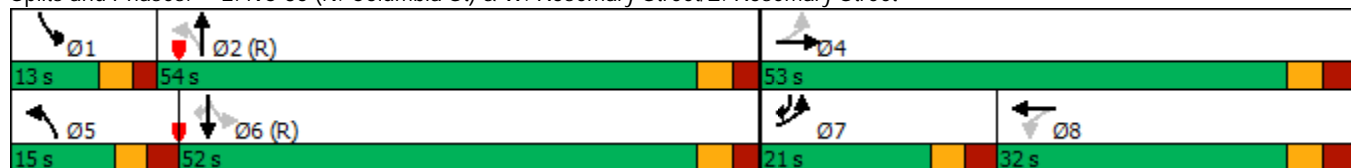

Lanes, Volumes, Timings
6: Henderson Street & E. Rosemary Street

2020 Existing AM Peak
Timing Plan: AM Peak



Lane Group	EBL	EBT	EBR	WBL	WBT	WBR	NBL	NBT	NBR	SBL	SBT	SBR
Lane Configurations												
Traffic Volume (vph)	5	131	56	8	269	16	52	6	8	9	16	5
Future Volume (vph)	5	131	56	8	269	16	52	6	8	9	16	5
Ideal Flow (vphpl)	1900	1900	1900	1900	1900	1900	1900	1900	1900	1900	1900	1900
Grade (%)		0%			0%			0%			3%	
Storage Length (ft)	85		0	0		0	0		0	0		0
Storage Lanes	1		0	0		0	0		0	0		0
Taper Length (ft)	25			25			25			25		
Lane Util. Factor	1.00	1.00	1.00	1.00	1.00	1.00	1.00	1.00	1.00	1.00	1.00	1.00
Ped Bike Factor	1.00	0.99			1.00			0.95			0.97	
Frt		0.955			0.993			0.984			0.979	
Flt Protected	0.950				0.999			0.962			0.985	
Satd. Flow (prot)	1593	1584	0	0	1660	0	0	1558	0	0	1559	0
Flt Permitted	0.570				0.993			0.742			0.884	
Satd. Flow (perm)	951	1584	0	0	1650	0	0	1157	0	0	1380	0
Right Turn on Red			No			No			No			No
Satd. Flow (RTOR)												
Link Speed (mph)		20			20			20			20	
Link Distance (ft)		156			1195			366			450	
Travel Time (s)		5.3			40.7			12.5			15.3	
Confl. Peds. (#/hr)	4		6	6		4	22		23	23		22
Peak Hour Factor	0.89	0.89	0.89	0.75	0.75	0.75	0.87	0.87	0.87	0.68	0.68	0.68
Heavy Vehicles (%)	2%	2%	2%	2%	2%	2%	3%	3%	3%	3%	3%	3%
Adj. Flow (vph)	6	147	63	11	359	21	60	7	9	13	24	7
Shared Lane Traffic (%)												
Lane Group Flow (vph)	6	210	0	0	391	0	0	76	0	0	44	0
Turn Type	Perm	NA		Perm	NA		Perm	NA		Perm	NA	
Protected Phases		2			2			4			4	
Permitted Phases	2			2			4			4		
Detector Phase	2	2		2	2		4	4		4	4	
Switch Phase												
Minimum Initial (s)	11.0	11.0		11.0	11.0		8.0	8.0		8.0	8.0	
Minimum Split (s)	15.9	15.9		15.9	15.9		17.8	17.8		17.8	17.8	
Total Split (s)	30.0	30.0		30.0	30.0		30.0	30.0		30.0	30.0	
Total Split (%)	50.0%	50.0%		50.0%	50.0%		50.0%	50.0%		50.0%	50.0%	
Maximum Green (s)	25.1	25.1		25.1	25.1		25.2	25.2		25.2	25.2	
Yellow Time (s)	3.3	3.3		3.3	3.3		3.3	3.3		3.3	3.3	
All-Red Time (s)	1.6	1.6		1.6	1.6		1.5	1.5		1.5	1.5	
Lost Time Adjust (s)	0.0	0.0			0.0			0.0			0.0	
Total Lost Time (s)	4.9	4.9			4.9			4.8			4.8	
Lead/Lag												
Lead-Lag Optimize?												
Vehicle Extension (s)	2.0	2.0		2.0	2.0		2.0	2.0		2.0	2.0	
Recall Mode	C-Max	C-Max		C-Max	C-Max		None	None		None	None	
Walk Time (s)	4.0	4.0		4.0	4.0		4.0	4.0		4.0	4.0	
Flash Dont Walk (s)	7.0	7.0		7.0	7.0		9.0	9.0		9.0	9.0	
Pedestrian Calls (#/hr)	0	0		0	0		0	0		0	0	
Act Effect Green (s)	44.6	44.6			44.6			9.2			9.2	
Actuated g/C Ratio	0.74	0.74			0.74			0.15			0.15	

Lanes, Volumes, Timings
 6: Henderson Street & E. Rosemary Street

2020 Existing AM Peak
 Timing Plan: AM Peak



Lane Group	EBL	EBT	EBR	WBL	WBT	WBR	NBL	NBT	NBR	SBL	SBT	SBR
v/c Ratio	0.01	0.18			0.32			0.43				0.21
Control Delay	2.8	3.0			5.3			26.9				23.9
Queue Delay	0.0	0.0			0.0			0.0				0.0
Total Delay	2.8	3.0			5.3			26.9				23.9
LOS	A	A			A			C				C
Approach Delay		3.0			5.3			26.9				23.9
Approach LOS		A			A			C				C
Queue Length 50th (ft)	1	20			54			36				15
Queue Length 95th (ft)	m2	42			107			26				27
Internal Link Dist (ft)		76			1115			286				370
Turn Bay Length (ft)	85											
Base Capacity (vph)	707	1178			1227			485				579
Starvation Cap Reductn	0	0			0			0				0
Spillback Cap Reductn	0	0			0			0				0
Storage Cap Reductn	0	0			0			0				0
Reduced v/c Ratio	0.01	0.18			0.32			0.16				0.08

Intersection Summary

Area Type: CBD
 Cycle Length: 60
 Actuated Cycle Length: 60
 Offset: 6 (10%), Referenced to phase 2:EBWB, Start of Green
 Natural Cycle: 40
 Control Type: Actuated-Coordinated
 Maximum v/c Ratio: 0.43
 Intersection Signal Delay: 8.0
 Intersection Capacity Utilization 42.4%
 Analysis Period (min) 15
 Intersection LOS: A
 ICU Level of Service A

m Volume for 95th percentile queue is metered by upstream signal.

Splits and Phases: 6: Henderson Street & E. Rosemary Street

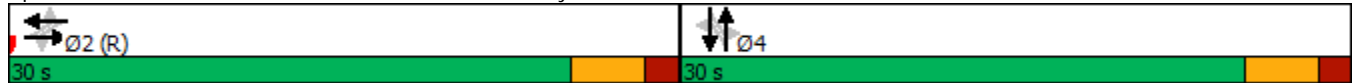

Lanes, Volumes, Timings
7: Hillsborough Street & E. Rosemary Street

2020 Existing AM Peak
Timing Plan: AM Peak



Lane Group	EBL	EBT	EBR	WBL	WBT	WBR	NBL	NBT	NBR	SBL	SBT	SBR
Lane Configurations		↕↕			↕↕		↗	↖		↗	↖	
Traffic Volume (vph)	2	56	67	0	108	12	173	133	6	21	311	26
Future Volume (vph)	2	56	67	0	108	12	173	133	6	21	311	26
Ideal Flow (vphpl)	1900	1900	1900	1900	1900	1900	1900	1900	1900	1900	1900	1900
Storage Length (ft)	0		0	0		0	100		0	100		0
Storage Lanes	0		0	0		0	1		0	1		0
Taper Length (ft)	25			25			25			25		
Lane Util. Factor	1.00	1.00	1.00	1.00	1.00	1.00	1.00	1.00	1.00	1.00	1.00	1.00
Ped Bike Factor		0.99			1.00			1.00		1.00	1.00	
Frt		0.927			0.986			0.994			0.988	
Flt Protected		0.999					0.950			0.950		
Satd. Flow (prot)	0	1701	0	0	1830	0	1752	1832	0	1752	1814	0
Flt Permitted		0.995					0.407			0.662		
Satd. Flow (perm)	0	1694	0	0	1830	0	751	1832	0	1215	1814	0
Right Turn on Red			No			No			No			No
Satd. Flow (RTOR)												
Link Speed (mph)		20			20			25			25	
Link Distance (ft)		1195			527			363			726	
Travel Time (s)		40.7			18.0			9.9			19.8	
Confl. Peds. (#/hr)	6		3	3		6	13		2	2		13
Peak Hour Factor	0.82	0.82	0.82	0.71	0.71	0.71	0.93	0.93	0.93	0.90	0.90	0.90
Heavy Vehicles (%)	2%	2%	2%	2%	2%	2%	3%	3%	3%	3%	3%	3%
Adj. Flow (vph)	2	68	82	0	152	17	186	143	6	23	346	29
Shared Lane Traffic (%)												
Lane Group Flow (vph)	0	152	0	0	169	0	186	149	0	23	375	0
Turn Type	Perm	NA			NA		pm+pt	NA		Perm	NA	
Protected Phases		4			8		5	2			6	
Permitted Phases	4			8			2			6		
Detector Phase	4	4		8	8		5	2		6	6	
Switch Phase												
Minimum Initial (s)	7.0	7.0		7.0	7.0		7.0	10.0		10.0	10.0	
Minimum Split (s)	19.9	19.9		17.0	17.0		11.8	14.8		14.8	14.8	
Total Split (s)	28.0	28.0		28.0	28.0		13.0	32.0		19.0	19.0	
Total Split (%)	46.7%	46.7%		46.7%	46.7%		21.7%	53.3%		31.7%	31.7%	
Maximum Green (s)	23.1	23.1		23.0	23.0		8.2	27.2		14.2	14.2	
Yellow Time (s)	3.0	3.0		3.3	3.3		3.0	3.3		3.1	3.1	
All-Red Time (s)	1.9	1.9		1.7	1.7		1.8	1.5		1.7	1.7	
Lost Time Adjust (s)		0.0			0.0		0.0	0.0		0.0	0.0	
Total Lost Time (s)		4.9			5.0		4.8	4.8		4.8	4.8	
Lead/Lag							Lead			Lag	Lag	
Lead-Lag Optimize?							Yes			Yes	Yes	
Vehicle Extension (s)	2.0	2.0		2.0	2.0		2.0	2.0		2.0	2.0	
Recall Mode	None	None		None	None		None	C-Max		C-Max	C-Max	
Walk Time (s)	4.0	4.0		4.0	4.0			4.0		4.0	4.0	
Flash Dont Walk (s)	11.0	11.0		8.0	8.0			6.0		6.0	6.0	
Pedestrian Calls (#/hr)	0	0		0	0			0		0	0	
Act Effct Green (s)		10.3			10.2		42.4	43.3		29.8	29.8	
Actuated g/C Ratio		0.17			0.17		0.71	0.72		0.50	0.50	
v/c Ratio		0.52			0.54		0.28	0.11		0.04	0.42	

Lanes, Volumes, Timings
7: Hillsborough Street & E. Rosemary Street

2020 Existing AM Peak
Timing Plan: AM Peak



Lane Group	EBL	EBT	EBR	WBL	WBT	WBR	NBL	NBT	NBR	SBL	SBT	SBR
Control Delay		20.3			28.8		6.8	5.8		11.5	13.8	
Queue Delay		0.0			0.0		0.0	0.0		0.0	0.1	
Total Delay		20.3			28.8		6.8	5.8		11.5	13.9	
LOS		C			C		A	A		B	B	
Approach Delay		20.3			28.8			6.3			13.8	
Approach LOS		C			C			A			B	
Queue Length 50th (ft)		35			57		42	31		4	84	
Queue Length 95th (ft)		49			75		66	54		18	185	
Internal Link Dist (ft)		1115			447			283			646	
Turn Bay Length (ft)							100			100		
Base Capacity (vph)		652			701		672	1323		603	901	
Starvation Cap Reductn		0			0		0	0		0	0	
Spillback Cap Reductn		0			0		0	0		0	63	
Storage Cap Reductn		0			0		0	0		0	0	
Reduced v/c Ratio		0.23			0.24		0.28	0.11		0.04	0.45	

Intersection Summary

Area Type:	Other
Cycle Length:	60
Actuated Cycle Length:	60
Offset:	12 (20%), Referenced to phase 2:NBTL and 6:SBTL, Start of Green
Natural Cycle:	55
Control Type:	Actuated-Coordinated
Maximum v/c Ratio:	0.54
Intersection Signal Delay:	14.8
Intersection LOS:	B
Intersection Capacity Utilization	49.0%
ICU Level of Service	A
Analysis Period (min)	15

Splits and Phases: 7: Hillsborough Street & E. Rosemary Street

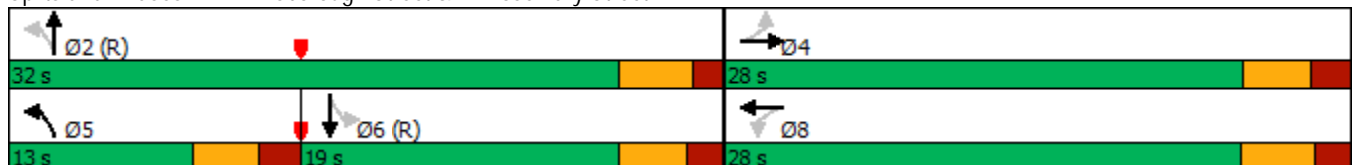

Lanes, Volumes, Timings
 8: Carolina Square Driveway/Church Street & W. Franklin Street

2020 Existing AM Peak
 Timing Plan: AM Peak



Lane Group	EBL	EBT	EBR	WBL	WBT	WBR	NBL	NBT	NBR	SBL	SBT	SBR
Lane Configurations												
Traffic Volume (vph)	44	321	23	10	237	42	2	5	10	20	20	48
Future Volume (vph)	44	321	23	10	237	42	2	5	10	20	20	48
Ideal Flow (vphpl)	1900	1900	1900	1900	1900	1900	1900	1900	1900	1900	1900	1900
Lane Width (ft)	10	10	16	10	10	10	12	12	12	12	12	12
Grade (%)		2%			-2%			-4%				-3%
Storage Length (ft)	150		0	200		0	0		100	0		0
Storage Lanes	1		0	1		0	0		1	0		0
Taper Length (ft)	25			25			25			25		
Lane Util. Factor	1.00	0.95	0.95	1.00	0.95	0.95	1.00	1.00	1.00	1.00	1.00	1.00
Ped Bike Factor	0.94	0.99		0.94	0.98			0.99	0.96		0.96	
Frt		0.990			0.977				0.850		0.927	
Flt Protected	0.950			0.950				0.985			0.989	
Satd. Flow (prot)	1430	2807	0	1431	2751	0	0	1621	1399	0	1466	0
Flt Permitted	0.549			0.512				0.884			0.917	
Satd. Flow (perm)	780	2807	0	725	2751	0	0	1435	1349	0	1352	0
Right Turn on Red			No			No			No			No
Satd. Flow (RTOR)												
Link Speed (mph)		20			20			20			25	
Link Distance (ft)		993			755			285			379	
Travel Time (s)		33.9			25.7			9.7			10.3	
Confl. Peds. (#/hr)	39		57	57		39	57		29	29		57
Peak Hour Factor	0.84	0.84	0.84	0.83	0.83	0.83	0.53	0.53	0.53	0.92	0.92	0.92
Heavy Vehicles (%)	5%	5%	5%	7%	7%	7%	6%	6%	6%	5%	5%	5%
Adj. Flow (vph)	52	382	27	12	286	51	4	9	19	22	22	52
Shared Lane Traffic (%)												
Lane Group Flow (vph)	52	409	0	12	337	0	0	13	19	0	96	0
Turn Type	Perm	NA		Perm	NA		Perm	NA	Perm	Perm	NA	
Protected Phases		2			6			8				4
Permitted Phases	2			6			8		8	4		
Detector Phase	2	2		6	6		8	8	8	4	4	
Switch Phase												
Minimum Initial (s)	10.0	10.0		10.0	10.0		7.0	7.0	7.0	7.0	7.0	
Minimum Split (s)	22.0	22.0		19.0	19.0		29.0	29.0	29.0	27.0	27.0	
Total Split (s)	31.0	31.0		31.0	31.0		29.0	29.0	29.0	29.0	29.0	
Total Split (%)	51.7%	51.7%		51.7%	51.7%		48.3%	48.3%	48.3%	48.3%	48.3%	
Maximum Green (s)	25.4	25.4		25.4	25.4		22.7	22.7	22.7	23.0	23.0	
Yellow Time (s)	3.3	3.3		3.3	3.3		3.1	3.1	3.1	3.4	3.4	
All-Red Time (s)	2.3	2.3		2.3	2.3		3.2	3.2	3.2	2.6	2.6	
Lost Time Adjust (s)	-0.6	-0.6		-0.6	-0.6		-1.3	-1.3	-1.3	-1.0	-1.0	
Total Lost Time (s)	5.0	5.0		5.0	5.0		5.0	5.0	5.0	5.0	5.0	
Lead/Lag												
Lead-Lag Optimize?												
Vehicle Extension (s)	3.0	3.0		3.0	3.0		2.0	2.0	2.0	2.0	2.0	
Recall Mode	C-Max	C-Max		C-Max	C-Max		None	None	None	None	None	
Walk Time (s)	7.0	7.0		7.0	7.0		7.0	7.0	7.0	7.0	7.0	
Flash Dont Walk (s)	9.0	9.0		6.0	6.0		15.0	15.0	15.0	14.0	14.0	
Pedestrian Calls (#/hr)	0	0		0	0		0	0	0	0	0	
Act Effect Green (s)	43.5	43.5		43.5	43.5		10.2	10.2	10.2	10.1	10.1	

Lanes, Volumes, Timings
 8: Carolina Square Driveway/Church Street & W. Franklin Street

2020 Existing AM Peak
 Timing Plan: AM Peak



Lane Group	EBL	EBT	EBR	WBL	WBT	WBR	NBL	NBT	NBR	SBL	SBT	SBR
Actuated g/C Ratio	0.72	0.72		0.72	0.72			0.17	0.17			0.17
v/c Ratio	0.09	0.20		0.02	0.17			0.05	0.08			0.42
Control Delay	4.8	4.3		4.4	3.4			19.9	20.4			22.2
Queue Delay	0.0	0.0		0.0	0.0			0.0	0.0			0.0
Total Delay	4.8	4.3		4.4	3.4			19.9	20.4			22.2
LOS	A	A		A	A			B	C			C
Approach Delay		4.4			3.4			20.2				22.2
Approach LOS		A			A			C				C
Queue Length 50th (ft)	5	23		1	10			4	6			30
Queue Length 95th (ft)	18	45		m9	68			9	12			54
Internal Link Dist (ft)		913			675			205				299
Turn Bay Length (ft)	150			200					100			
Base Capacity (vph)	565	2033		525	1992			574	539			540
Starvation Cap Reductn	0	0		0	0			0	0			0
Spillback Cap Reductn	0	0		0	0			0	0			0
Storage Cap Reductn	0	0		0	0			0	0			0
Reduced v/c Ratio	0.09	0.20		0.02	0.17			0.02	0.04			0.18

Intersection Summary

Area Type: CBD
 Cycle Length: 60
 Actuated Cycle Length: 60
 Offset: 0 (0%), Referenced to phase 2:EBTL and 6:WBTL, Start of Green
 Natural Cycle: 55
 Control Type: Actuated-Coordinated
 Maximum v/c Ratio: 0.42
 Intersection Signal Delay: 6.4 Intersection LOS: A
 Intersection Capacity Utilization 55.5% ICU Level of Service B
 Analysis Period (min) 15
 m Volume for 95th percentile queue is metered by upstream signal.



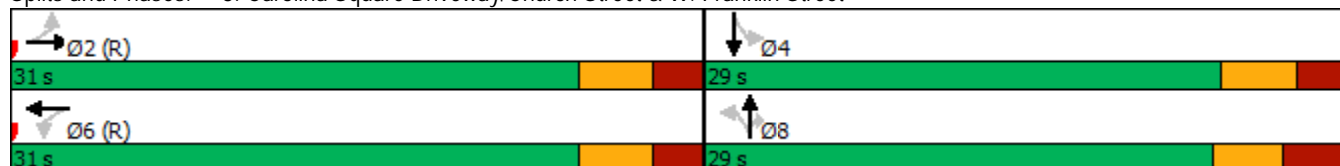

















Splits and Phases: 8: Carolina Square Driveway/Church Street & W. Franklin Street



Lanes, Volumes, Timings

2020 Existing AM Peak

9: NC 86 (S. Columbia St)/NC 86 (N. Columbia St) & W. Franklin Street/E. Franklin Street

												
Lane Group	EBL	EBT	EBR	WBL	WBT	WBR	NBL	NBT	NBR	SBL	SBT	SBR
Lane Configurations												
Traffic Volume (vph)	60	277	28	64	270	45	29	271	85	35	439	72
Future Volume (vph)	60	277	28	64	270	45	29	271	85	35	439	72
Ideal Flow (vphpl)	1900	1900	1900	1900	1900	1900	1900	1900	1900	1900	1900	1900
Lane Width (ft)	9	12	13	10	10	13	9	10	10	9	9	11
Grade (%)		3%			1%			-2%			3%	
Storage Length (ft)	250		0	125		0	475		0	125		0
Storage Lanes	1		0	1		0	1		0	1		0
Taper Length (ft)	25			25			25			25		
Lane Util. Factor	1.00	0.95	0.95	1.00	0.95	0.95	1.00	0.95	0.95	1.00	0.95	0.95
Ped Bike Factor	0.88	0.99		0.95	0.97		0.98	0.96		0.91	0.99	
Frt		0.986			0.978			0.964			0.979	
Flt Protected	0.950			0.950			0.950			0.950		
Satd. Flow (prot)	1372	2980	0	1410	2674	0	1342	2576	0	1346	2613	0
Flt Permitted	0.950			0.950			0.950			0.950		
Satd. Flow (perm)	1202	2980	0	1343	2674	0	1315	2576	0	1219	2613	0
Right Turn on Red			No			No			No			No
Satd. Flow (RTOR)												
Link Speed (mph)		20			20			25			25	
Link Distance (ft)		755			941			981			353	
Travel Time (s)		25.7			32.1			26.8			9.6	
Confl. Peds. (#/hr)	125		49	49		125	29		98	98		29
Peak Hour Factor	0.80	0.80	0.80	0.87	0.87	0.87	0.93	0.93	0.93	0.85	0.85	0.85
Heavy Vehicles (%)	5%	5%	5%	7%	7%	7%	10%	10%	10%	7%	7%	7%
Adj. Flow (vph)	75	346	35	74	310	52	31	291	91	41	516	85
Shared Lane Traffic (%)												
Lane Group Flow (vph)	75	381	0	74	362	0	31	382	0	41	601	0
Turn Type	Prot	NA		Prot	NA		Prot	NA		Prot	NA	
Protected Phases	5	2		1	6		3	8		7	4	
Permitted Phases												
Detector Phase	5	2		1	6		3	8		7	4	
Switch Phase												
Minimum Initial (s)	7.0	10.0		7.0	10.0		7.0	7.0		7.0	7.0	
Minimum Split (s)	15.0	28.2		15.0	28.2		15.0	28.0		15.0	28.1	
Total Split (s)	22.0	38.0		22.0	38.0		22.0	38.0		22.0	38.0	
Total Split (%)	18.3%	31.7%		18.3%	31.7%		18.3%	31.7%		18.3%	31.7%	
Maximum Green (s)	16.6	31.8		16.1	31.8		16.1	32.1		16.1	32.3	
Yellow Time (s)	3.0	3.0		3.0	3.0		3.0	3.3		3.0	3.1	
All-Red Time (s)	2.4	3.2		2.9	3.2		2.9	2.6		2.9	2.6	
Lost Time Adjust (s)	-0.4	-1.2		-0.9	-1.2		-0.9	-0.9		-0.9	-0.7	
Total Lost Time (s)	5.0	5.0		5.0	5.0		5.0	5.0		5.0	5.0	
Lead/Lag	Lead	Lag		Lead	Lag		Lead	Lag		Lead	Lag	
Lead-Lag Optimize?	Yes	Yes		Yes	Yes		Yes	Yes		Yes	Yes	
Vehicle Extension (s)	1.0	3.0		1.0	3.0		1.0	2.0		1.0	2.0	
Recall Mode	None	C-Max		None	C-Max		None	Ped		None	Ped	
Walk Time (s)		7.0			7.0			7.0			7.0	
Flash Dont Walk (s)		15.0			15.0			15.0			15.0	
Pedestrian Calls (#/hr)		0			0			0			0	
Act Effect Green (s)	10.9	54.2		11.1	54.4		8.6	30.8		9.1	33.9	

Lanes, Volumes, Timings

2020 Existing AM Peak

9: NC 86 (S. Columbia St)/NC 86 (N. Columbia St) & W. Franklin Street/E. Franklin Street



Lane Group	EBL	EBT	EBR	WBL	WBT	WBR	NBL	NBT	NBR	SBL	SBT	SBR
Actuated g/C Ratio	0.09	0.45		0.09	0.45		0.07	0.26		0.08	0.28	
v/c Ratio	0.60	0.28		0.57	0.30		0.33	0.58		0.41	0.82	
Control Delay	70.2	29.2		78.3	15.1		36.2	34.9		92.5	30.9	
Queue Delay	0.0	0.0		0.0	0.0		0.0	0.0		0.0	0.1	
Total Delay	70.2	29.2		78.3	15.1		36.2	34.9		92.5	31.0	
LOS	E	C		E	B		D	C		F	C	
Approach Delay		35.9			25.8			35.0			34.9	
Approach LOS		D			C			C			C	
Queue Length 50th (ft)	49	103		48	111		24	153		30	234	
Queue Length 95th (ft)	93	183		103	71		m38	211		69	124	
Internal Link Dist (ft)		675			861			901			273	
Turn Bay Length (ft)	250			125			475			125		
Base Capacity (vph)	194	1346		199	1211		190	736		190	770	
Starvation Cap Reductn	0	0		0	0		0	0		0	8	
Spillback Cap Reductn	0	0		0	0		0	0		0	0	
Storage Cap Reductn	0	0		0	0		0	0		0	0	
Reduced v/c Ratio	0.39	0.28		0.37	0.30		0.16	0.52		0.22	0.79	

Intersection Summary

Area Type: CBD
 Cycle Length: 120
 Actuated Cycle Length: 120
 Offset: 42 (35%), Referenced to phase 2:EBT and 6:WBT, Start of Green
 Natural Cycle: 90
 Control Type: Actuated-Coordinated
 Maximum v/c Ratio: 0.82
 Intersection Signal Delay: 33.1 Intersection LOS: C
 Intersection Capacity Utilization 65.0% ICU Level of Service C
 Analysis Period (min) 15
 m Volume for 95th percentile queue is metered by upstream signal.

Splits and Phases: 9: NC 86 (S. Columbia St)/NC 86 (N. Columbia St) & W. Franklin Street/E. Franklin Street

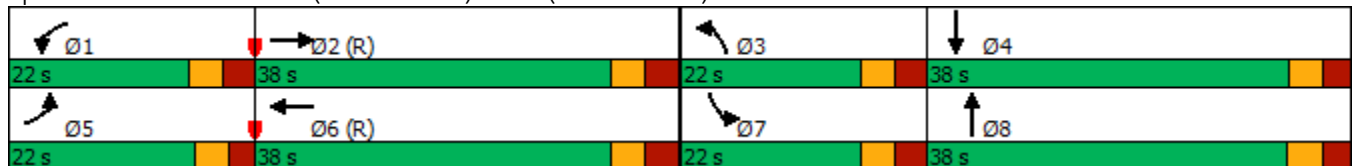

Lanes, Volumes, Timings
 10: E. Franklin Street & Henderson Street

2020 Existing AM Peak
 Timing Plan: AM Peak



Lane Group	EBL	EBT	WBT	WBR	SBL	SBR
Lane Configurations		↕↕	↕↔		↔↕	
Traffic Volume (vph)	15	359	376	57	59	17
Future Volume (vph)	15	359	376	57	59	17
Ideal Flow (vphpl)	1900	1900	1900	1900	1900	1900
Lane Width (ft)	10	13	10	10	11	11
Grade (%)		-2%	2%		3%	
Lane Util. Factor	0.95	0.95	0.95	0.95	1.00	1.00
Ped Bike Factor		1.00	0.99		0.95	
Frt			0.980		0.969	
Flt Protected		0.998			0.963	
Satd. Flow (prot)	0	3223	2776	0	1430	0
Flt Permitted		0.934			0.963	
Satd. Flow (perm)	0	3013	2776	0	1384	0
Right Turn on Red				No		No
Satd. Flow (RTOR)						
Link Speed (mph)		20	20		20	
Link Distance (ft)		941	1200		366	
Travel Time (s)		32.1	40.9		12.5	
Confl. Peds. (#/hr)	26			26	44	87
Peak Hour Factor	0.91	0.91	0.90	0.90	0.79	0.79
Heavy Vehicles (%)	5%	5%	5%	5%	4%	4%
Parking (#/hr)						0
Adj. Flow (vph)	16	395	418	63	75	22
Shared Lane Traffic (%)						
Lane Group Flow (vph)	0	411	481	0	97	0
Turn Type	Perm	NA	NA		Prot	
Protected Phases		2	6		4	
Permitted Phases	2					
Detector Phase	2	2	6		4	
Switch Phase						
Minimum Initial (s)	10.0	10.0	10.0		7.0	
Minimum Split (s)	17.0	17.0	22.0		25.0	
Total Split (s)	35.0	35.0	35.0		25.0	
Total Split (%)	58.3%	58.3%	58.3%		41.7%	
Maximum Green (s)	28.8	28.8	28.9		19.9	
Yellow Time (s)	3.0	3.0	3.0		3.0	
All-Red Time (s)	3.2	3.2	3.1		2.1	
Lost Time Adjust (s)		-1.2	-1.1		-0.1	
Total Lost Time (s)		5.0	5.0		5.0	
Lead/Lag						
Lead-Lag Optimize?						
Vehicle Extension (s)	2.0	2.0	2.0		1.0	
Recall Mode	C-Max	C-Max	C-Max		None	
Walk Time (s)			7.0		7.0	
Flash Dont Walk (s)			8.0		12.0	
Pedestrian Calls (#/hr)			0		0	
Act Effct Green (s)		44.8	44.8		8.6	
Actuated g/C Ratio		0.75	0.75		0.14	
v/c Ratio		0.18	0.23		0.48	

Lanes, Volumes, Timings
 10: E. Franklin Street & Henderson Street

2020 Existing AM Peak
 Timing Plan: AM Peak



Lane Group	EBL	EBT	WBT	WBR	SBL	SBR
Control Delay		5.8	5.4		24.0	
Queue Delay		0.0	0.0		0.0	
Total Delay		5.8	5.4		24.0	
LOS		A	A		C	
Approach Delay		5.8	5.4		24.0	
Approach LOS		A	A		C	
Queue Length 50th (ft)		84	19		29	
Queue Length 95th (ft)		95	160		38	
Internal Link Dist (ft)		861	1120		286	
Turn Bay Length (ft)						
Base Capacity (vph)		2251	2074		476	
Starvation Cap Reductn		0	0		0	
Spillback Cap Reductn		0	0		0	
Storage Cap Reductn		0	0		0	
Reduced v/c Ratio		0.18	0.23		0.20	

Intersection Summary

Area Type:	CBD
Cycle Length:	60
Actuated Cycle Length:	60
Offset:	30 (50%), Referenced to phase 2:EBTL and 6:WBT, Start of Green
Natural Cycle:	50
Control Type:	Actuated-Coordinated
Maximum v/c Ratio:	0.48
Intersection Signal Delay:	7.4
Intersection LOS:	A
Intersection Capacity Utilization:	46.9%
ICU Level of Service:	A
Analysis Period (min):	15

Splits and Phases: 10: E. Franklin Street & Henderson Street

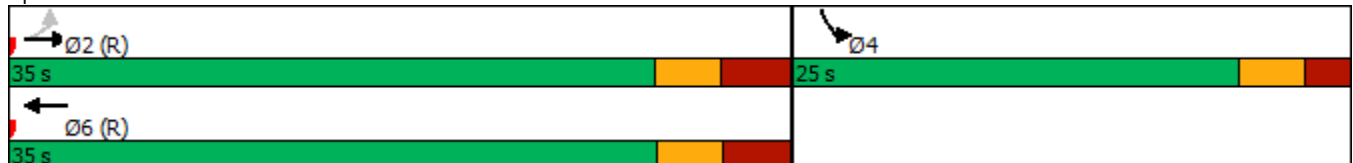

Lanes, Volumes, Timings
 11: Raleigh Street/Hillsborough Street & E. Franklin Street

2020 Existing AM Peak
 Timing Plan: AM Peak



Lane Group	EBL	EBT	EBR	WBL	WBT	WBR	NBL	NBT	NBR	SBL	SBT	SBR
Lane Configurations												
Traffic Volume (vph)	19	301	102	41	401	110	74	185	23	42	316	18
Future Volume (vph)	19	301	102	41	401	110	74	185	23	42	316	18
Ideal Flow (vphpl)	1900	1900	1900	1900	1900	1900	1900	1900	1900	1900	1900	1900
Lane Width (ft)	9	9	10	9	10	11	12	12	12	10	10	10
Grade (%)		1%			-2%			1%			1%	
Storage Length (ft)	75		0	75		0	0		0	100		0
Storage Lanes	1		0	1		0	0		0	1		0
Taper Length (ft)	25			25			25			25		
Lane Util. Factor	1.00	0.95	0.95	1.00	0.95	0.95	1.00	1.00	1.00	1.00	1.00	1.00
Ped Bike Factor	0.99	0.99		0.99	0.99			0.99		0.99	1.00	
Frt		0.962			0.968			0.989			0.992	
Flt Protected	0.950			0.950				0.987		0.950		
Satd. Flow (prot)	1539	2929	0	1578	3145	0	0	1770	0	1627	1695	0
Flt Permitted	0.412			0.461				0.584		0.459		
Satd. Flow (perm)	664	2929	0	757	3145	0	0	1043	0	779	1695	0
Right Turn on Red			No			No			No			No
Satd. Flow (RTOR)												
Link Speed (mph)		20			30			25			25	
Link Distance (ft)		1200			1013			995			363	
Travel Time (s)		40.9			23.0			27.1			9.9	
Confl. Peds. (#/hr)	9		16	16		9	25		11	11		25
Peak Hour Factor	0.86	0.86	0.86	0.92	0.92	0.92	0.83	0.83	0.83	0.96	0.96	0.96
Heavy Vehicles (%)	5%	5%	5%	4%	4%	4%	4%	4%	4%	3%	3%	3%
Adj. Flow (vph)	22	350	119	45	436	120	89	223	28	44	329	19
Shared Lane Traffic (%)												
Lane Group Flow (vph)	22	469	0	45	556	0	0	340	0	44	348	0
Turn Type	Perm	NA		Perm	NA		pm+pt	NA		D.Pm	NA	
Protected Phases		2			6		7	4				8
Permitted Phases	2			6			4			4		
Detector Phase	2	2		6	6		7	4		4		8
Switch Phase												
Minimum Initial (s)	10.0	10.0		10.0	10.0		7.0	7.0		7.0	7.0	
Minimum Split (s)	16.0	16.0		16.0	16.0		14.0	30.0		30.0	29.0	
Total Split (s)	45.0	45.0		45.0	45.0		14.0	75.0		75.0	61.0	
Total Split (%)	37.5%	37.5%		37.5%	37.5%		11.7%	62.5%		62.5%	50.8%	
Maximum Green (s)	39.7	39.7		39.7	39.7		7.8	68.6		68.6	54.6	
Yellow Time (s)	3.0	3.0		3.0	3.0		3.0	3.1		3.1	3.1	
All-Red Time (s)	2.3	2.3		2.3	2.3		3.2	3.3		3.3	3.3	
Lost Time Adjust (s)	-0.3	-0.3		-0.3	-0.3			-1.4		-1.4	-1.4	
Total Lost Time (s)	5.0	5.0		5.0	5.0			5.0		5.0	5.0	
Lead/Lag							Lead				Lag	
Lead-Lag Optimize?							Yes				Yes	
Vehicle Extension (s)	3.0	3.0		3.0	3.0		3.0	2.0		2.0	2.0	
Recall Mode	C-Max	C-Max		C-Max	C-Max		None	None		None	None	
Walk Time (s)								7.0		7.0	7.0	
Flash Dont Walk (s)								16.0		16.0	15.0	
Pedestrian Calls (#/hr)								0		0	0	
Act Effect Green (s)	68.7	68.7		68.7	68.7			41.3		41.3	41.3	

Lanes, Volumes, Timings
 11: Raleigh Street/Hillsborough Street & E. Franklin Street

2020 Existing AM Peak
 Timing Plan: AM Peak



Lane Group	EBL	EBT	EBR	WBL	WBT	WBR	NBL	NBT	NBR	SBL	SBT	SBR
Actuated g/C Ratio	0.57	0.57		0.57	0.57			0.34		0.34	0.34	
v/c Ratio	0.06	0.28		0.10	0.31			0.95		0.16	0.60	
Control Delay	19.1	15.8		16.3	15.7			73.2		30.1	41.3	
Queue Delay	0.0	0.0		0.0	0.0			0.0		0.0	1.4	
Total Delay	19.1	15.8		16.3	15.7			73.2		30.1	42.7	
LOS	B	B		B	B			E		C	D	
Approach Delay		16.0			15.7			73.2			41.2	
Approach LOS		B			B			E			D	
Queue Length 50th (ft)	5	86		15	111			255		28	258	
Queue Length 95th (ft)	28	157		45	193			284		46	352	
Internal Link Dist (ft)		1120			933			915			283	
Turn Bay Length (ft)	75			75						100		
Base Capacity (vph)	379	1676		433	1800			608		454	791	
Starvation Cap Reductn	0	0		0	0			0		0	259	
Spillback Cap Reductn	0	0		0	0			0		0	0	
Storage Cap Reductn	0	0		0	0			0		0	0	
Reduced v/c Ratio	0.06	0.28		0.10	0.31			0.56		0.10	0.65	

Intersection Summary

Area Type: Other
 Cycle Length: 120
 Actuated Cycle Length: 120
 Offset: 91 (76%), Referenced to phase 2:EBTL and 6:WBTL, Start of Green
 Natural Cycle: 60
 Control Type: Actuated-Coordinated
 Maximum v/c Ratio: 0.95
 Intersection Signal Delay: 32.0
 Intersection LOS: C
 Intersection Capacity Utilization 74.4%
 ICU Level of Service D
 Analysis Period (min) 15

Splits and Phases: 11: Raleigh Street/Hillsborough Street & E. Franklin Street

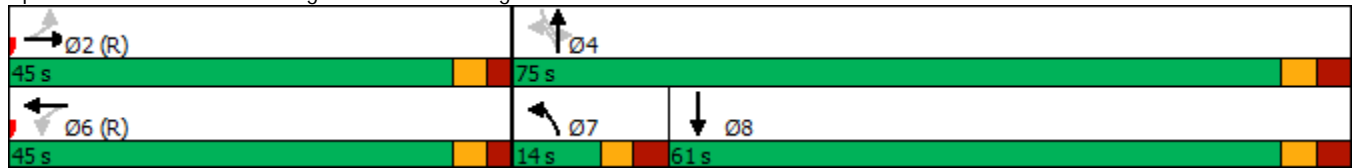

Lanes, Volumes, Timings

2020 Existing AM Peak

14: NC 86 (MLK Jr. Blvd) & Longview Street/Mill Creek Apts Driveway

Timing Plan: AM Peak

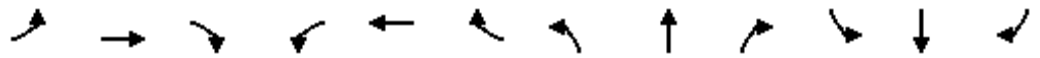

Lane Group	EBL	EBT	EBR	WBL	WBT	WBR	NBL	NBT	NBR	SBL	SBT	SBR
Lane Configurations		↕			↕		↕	↕↔		↕	↕↔	
Traffic Volume (vph)	75	0	10	6	0	5	2	412	5	0	666	65
Future Volume (vph)	75	0	10	6	0	5	2	412	5	0	666	65
Ideal Flow (vphpl)	1900	1900	1900	1900	1900	1900	1900	1900	1900	1900	1900	1900
Grade (%)		-6%			1%			2%			-4%	
Storage Length (ft)	0		0	0		0	225		0	250		0
Storage Lanes	0		0	0		0	1		0	1		0
Taper Length (ft)	25			25			25			25		
Lane Util. Factor	1.00	1.00	1.00	1.00	1.00	1.00	1.00	0.95	0.95	1.00	0.95	0.95
Ped Bike Factor		1.00			0.99		1.00	1.00			1.00	
Frt		0.984			0.944			0.998			0.987	
Flt Protected		0.958			0.972		0.950					
Satd. Flow (prot)	0	1735	0	0	1701	0	1686	3364	0	1846	3452	0
Flt Permitted		0.742			0.815		0.290					
Satd. Flow (perm)	0	1344	0	0	1417	0	513	3364	0	1846	3452	0
Right Turn on Red			No			No			No			No
Satd. Flow (RTOR)												
Link Speed (mph)		25			20			35			35	
Link Distance (ft)		451			338			2108			784	
Travel Time (s)		12.3			11.5			41.1			15.3	
Confl. Peds. (#/hr)			16	16			4		4	4		4
Peak Hour Factor	0.52	0.52	0.52	0.92	0.92	0.92	0.93	0.93	0.93	0.84	0.84	0.84
Heavy Vehicles (%)	6%	6%	6%	2%	2%	2%	6%	6%	6%	5%	5%	5%
Adj. Flow (vph)	144	0	19	7	0	5	2	443	5	0	793	77
Shared Lane Traffic (%)												
Lane Group Flow (vph)	0	163	0	0	12	0	2	448	0	0	870	0
Turn Type	Perm	NA		Perm	NA		Perm	NA		Perm	NA	
Protected Phases		4			8			2			6	
Permitted Phases	4			8			2			6		
Detector Phase	4	4		8	8		2	2		6	6	
Switch Phase												
Minimum Initial (s)	7.0	7.0		7.0	7.0		12.0	12.0		12.0	12.0	
Minimum Split (s)	31.0	31.0		14.0	14.0		28.0	28.0		28.0	28.0	
Total Split (s)	20.0	20.0		20.0	20.0		60.0	60.0		60.0	60.0	
Total Split (%)	25.0%	25.0%		25.0%	25.0%		75.0%	75.0%		75.0%	75.0%	
Maximum Green (s)	14.0	14.0		13.9	13.9		54.0	54.0		54.5	54.5	
Yellow Time (s)	3.5	3.5		3.0	3.0		4.5	4.5		4.0	4.0	
All-Red Time (s)	2.5	2.5		3.1	3.1		1.5	1.5		1.5	1.5	
Lost Time Adjust (s)		-1.0			-1.0		-1.0	-1.0		-0.5	-0.5	
Total Lost Time (s)		5.0			5.1		5.0	5.0		5.0	5.0	
Lead/Lag												
Lead-Lag Optimize?												
Vehicle Extension (s)	3.0	3.0		3.0	3.0		3.0	3.0		3.0	3.0	
Recall Mode	None	None		None	None		Min	Min		Min	Min	
Walk Time (s)	7.0	7.0					7.0	7.0		7.0	7.0	
Flash Dont Walk (s)	17.0	17.0					9.0	9.0		9.0	9.0	
Pedestrian Calls (#/hr)	0	0					0	0		0	0	
Act Effct Green (s)		11.5			11.4		21.4	21.4			21.4	
Actuated g/C Ratio		0.27			0.27		0.50	0.50			0.50	

Lanes, Volumes, Timings
 14: NC 86 (MLK Jr. Blvd) & Longview Street/Mill Creek Apts Driveway

2020 Existing AM Peak
 Timing Plan: AM Peak



Lane Group	EBL	EBT	EBR	WBL	WBT	WBR	NBL	NBT	NBR	SBL	SBT	SBR
v/c Ratio		0.45			0.03		0.01	0.27				0.51
Control Delay		17.5			12.0		6.5	7.2				8.9
Queue Delay		0.0			0.0		0.0	0.0				0.0
Total Delay		17.5			12.0		6.5	7.2				8.9
LOS		B			B		A	A				A
Approach Delay		17.5			12.0			7.2				8.9
Approach LOS		B			B			A				A
Queue Length 50th (ft)		29			2		0	28				64
Queue Length 95th (ft)		41			11		3	58				108
Internal Link Dist (ft)		371			258			2028				704
Turn Bay Length (ft)							225					
Base Capacity (vph)		475			497		513	3364				3452
Starvation Cap Reductn		0			0		0	0				0
Spillback Cap Reductn		0			0		0	0				0
Storage Cap Reductn		0			0		0	0				0
Reduced v/c Ratio		0.34			0.02		0.00	0.13				0.25

Intersection Summary

Area Type: Other
 Cycle Length: 80
 Actuated Cycle Length: 43
 Natural Cycle: 60
 Control Type: Actuated-Uncoordinated
 Maximum v/c Ratio: 0.51
 Intersection Signal Delay: 9.4
 Intersection Capacity Utilization 41.5%
 Analysis Period (min) 15
 Intersection LOS: A
 ICU Level of Service A

Splits and Phases: 14: NC 86 (MLK Jr. Blvd) & Longview Street/Mill Creek Apts Driveway

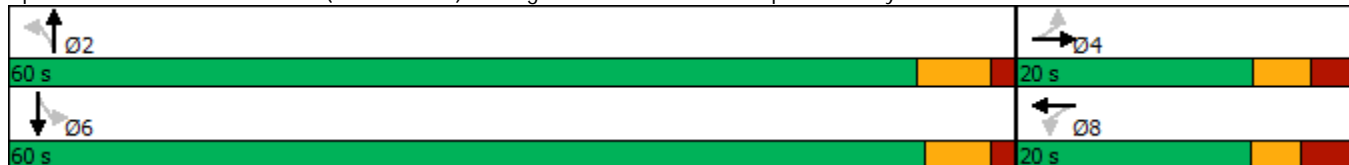

Lanes, Volumes, Timings
 15: NC 86 (Pittsboro St) & W. Cameron Avenue

2020 Existing AM Peak
 Timing Plan: AM Peak



Lane Group	EBT	EBR	WBL	WBT	NBL	NBR	Ø1	Ø4
Lane Configurations	↻		↻↻	↻				
Traffic Volume (vph)	111	156	578	131	0	0		
Future Volume (vph)	111	156	578	131	0	0		
Ideal Flow (vphpl)	1900	1900	1900	1900	1900	1900		
Lane Width (ft)	12	12	11	12	12	12		
Grade (%)	3%			-3%	0%			
Storage Length (ft)		0	75		0	0		
Storage Lanes		0	0		0	0		
Taper Length (ft)			25		25			
Lane Util. Factor	1.00	1.00	0.97	1.00	1.00	1.00		
Ped Bike Factor	0.94		0.90					
Frt	0.921							
Flt Protected			0.950					
Satd. Flow (prot)	1429	0	2837	1592	0	0		
Flt Permitted			0.950					
Satd. Flow (perm)	1429	0	2558	1592	0	0		
Right Turn on Red		No				No		
Satd. Flow (RTOR)								
Link Speed (mph)	25			25	25			
Link Distance (ft)	391			120	794			
Travel Time (s)	30.0			10.7	21.7			
Confl. Peds. (#/hr)		57	57					
Peak Hour Factor	0.81	0.81	0.87	0.87	0.90	0.90		
Heavy Vehicles (%)	2%	2%	9%	9%	2%	2%		
Adj. Flow (vph)	137	193	664	151	0	0		
Shared Lane Traffic (%)								
Lane Group Flow (vph)	330	0	664	151	0	0		
Turn Type	NA		Prot	NA				
Protected Phases	2		1 4	6			1	4
Permitted Phases								
Detector Phase	2		1 4	6				
Switch Phase								
Minimum Initial (s)	10.0			10.0			7.0	7.0
Minimum Split (s)	17.0			15.0			13.0	20.0
Total Split (s)	20.0			40.0			20.0	20.0
Total Split (%)	33.3%			66.7%			33%	33%
Maximum Green (s)	14.9			35.0			14.9	16.0
Yellow Time (s)	3.0			3.3			3.0	3.0
All-Red Time (s)	2.1			1.7			2.1	1.0
Lost Time Adjust (s)	-0.1			0.0				
Total Lost Time (s)	5.0			5.0				
Lead/Lag	Lag						Lead	
Lead-Lag Optimize?								
Vehicle Extension (s)	1.0			1.0			4.0	0.2
Recall Mode	None			C-Max			C-Max	None
Walk Time (s)	7.0							7.0
Flash Dont Walk (s)	4.0							9.0
Pedestrian Calls (#/hr)	0							0
Act Effect Green (s)	15.0		35.0	40.5				

Lanes, Volumes, Timings
 15: NC 86 (Pittsboro St) & W. Cameron Avenue

2020 Existing AM Peak
 Timing Plan: AM Peak



Lane Group	EBT	EBR	WBL	WBT	NBL	NBR	Ø1	Ø4
Actuated g/C Ratio	0.25		0.58	0.68				
v/c Ratio	0.92		0.40	0.14				
Control Delay	58.1		11.3	5.0				
Queue Delay	0.0		0.0	0.0				
Total Delay	58.1		11.3	5.0				
LOS	E		B	A				
Approach Delay	58.1			10.2				
Approach LOS	E			B				
Queue Length 50th (ft)	116		151	34				
Queue Length 95th (ft)	#214		229	m61				
Internal Link Dist (ft)	311			40	714			
Turn Bay Length (ft)			75					
Base Capacity (vph)	357		1612	1073				
Starvation Cap Reductn	0		0	0				
Spillback Cap Reductn	0		0	0				
Storage Cap Reductn	0		0	0				
Reduced v/c Ratio	0.92		0.41	0.14				

Intersection Summary

Area Type: CBD
 Cycle Length: 60
 Actuated Cycle Length: 60
 Offset: 50 (83%), Referenced to phase 1:WBL and 6:WBT, Start of Green
 Natural Cycle: 60
 Control Type: Actuated-Coordinated
 Maximum v/c Ratio: 0.92
 Intersection Signal Delay: 24.0 Intersection LOS: C
 Intersection Capacity Utilization 46.3% ICU Level of Service A
 Analysis Period (min) 15
 # 95th percentile volume exceeds capacity, queue may be longer.
 Queue shown is maximum after two cycles.
 m Volume for 95th percentile queue is metered by upstream signal.

Splits and Phases: 15: NC 86 (Pittsboro St) & W. Cameron Avenue

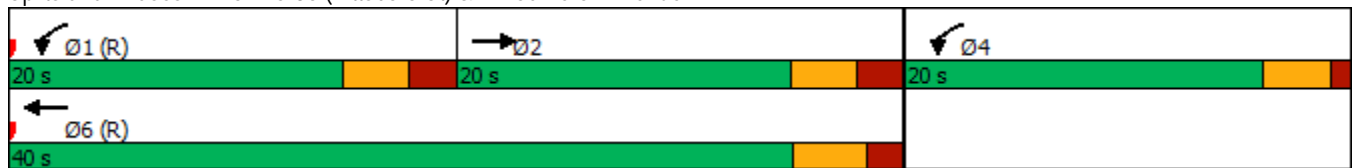

Lanes, Volumes, Timings

2020 Existing AM Peak

16: NC 86 (S. Columbia St) & W. Cameron Avenue/E. Cameron Avenue

Timing Plan: AM Peak



Lane Group	EBL	EBT	EBR	WBL	WBT	WBR	NBL	NBT	NBR	SBL	SBT	SBR
Lane Configurations												
Traffic Volume (vph)	12	89	0	0	93	20	96	348	42	65	0	516
Future Volume (vph)	12	89	0	0	93	20	96	348	42	65	0	516
Ideal Flow (vphpl)	1900	1900	1900	1900	1900	1900	1900	1900	1900	1900	1900	1900
Lane Width (ft)	11	12	12	12	12	12	10	10	10	11	11	12
Grade (%)		1%			-1%			1%			2%	
Storage Length (ft)	100		0	0		0	0		0	310		0
Storage Lanes	1		0	0		0	1		0	1		2
Taper Length (ft)	25			25			25			25		
Lane Util. Factor	1.00	1.00	1.00	1.00	1.00	1.00	0.91	0.91	0.95	1.00	1.00	0.88
Ped Bike Factor	0.95				0.99		0.79	0.94		0.73		0.77
Frt					0.976			0.984				0.850
Flt Protected	0.950						0.950	0.999		0.950		
Satd. Flow (prot)	1532	1668	0	0	1563	0	1248	2442	0	1413	0	2302
Flt Permitted	0.527						0.950	0.999		0.950		
Satd. Flow (perm)	811	1668	0	0	1563	0	982	2430	0	1038	0	1776
Right Turn on Red			No			No			No			No
Satd. Flow (RTOR)												
Link Speed (mph)		25			25			25				25
Link Distance (ft)		273			989			826				981
Travel Time (s)		10.7			57.6			22.5				26.8
Confl. Peds. (#/hr)	39		102	102		39	71		107	107		71
Peak Hour Factor	0.79	0.79	0.79	0.83	0.83	0.83	0.86	0.86	0.86	0.89	0.89	0.89
Heavy Vehicles (%)	2%	2%	2%	6%	6%	6%	10%	10%	10%	10%	10%	10%
Adj. Flow (vph)	15	113	0	0	112	24	112	405	49	73	0	580
Shared Lane Traffic (%)							10%					
Lane Group Flow (vph)	15	113	0	0	136	0	101	465	0	73	0	580
Turn Type	Perm	NA			NA		Split	NA		Prot		Prot
Protected Phases		4			8		2	2		1		1
Permitted Phases	4									1		1
Detector Phase	4	4			8		2	2		1		1
Switch Phase												
Minimum Initial (s)	10.0	10.0			10.0		7.0	7.0		7.0		7.0
Minimum Split (s)	24.0	24.0			31.0		18.0	18.0		26.0		26.0
Total Split (s)	31.0	31.0			31.0		26.0	26.0		35.0		35.0
Total Split (%)	25.8%	25.8%			25.8%		21.7%	21.7%		29.2%		29.2%
Maximum Green (s)	24.8	24.8			24.8		20.1	20.1		29.4		29.4
Yellow Time (s)	3.2	3.2			3.2		3.1	3.1		3.0		3.0
All-Red Time (s)	3.0	3.0			3.0		2.8	2.8		2.6		2.6
Lost Time Adjust (s)	-1.2	-1.2			-1.2		-0.9	-0.9		-0.6		-0.6
Total Lost Time (s)	5.0	5.0			5.0		5.0	5.0		5.0		5.0
Lead/Lag							Lag	Lag		Lead		Lead
Lead-Lag Optimize?							Yes	Yes		Yes		Yes
Vehicle Extension (s)	2.0	2.0			2.0		4.0	4.0		4.0		4.0
Recall Mode	None	None			None		C-Max	C-Max		None		None
Walk Time (s)	7.0	7.0			7.0		7.0	7.0		7.0		7.0
Flash Dont Walk (s)	10.0	10.0			17.0		5.0	5.0		13.0		13.0
Pedestrian Calls (#/hr)	0	0			0		0	0		0		0
Act Effect Green (s)	16.3	16.3			16.3		48.3	48.3		40.4		40.4

Lane Group	Ø9
Lane Configurations	
Traffic Volume (vph)	
Future Volume (vph)	
Ideal Flow (vphpl)	
Lane Width (ft)	
Grade (%)	
Storage Length (ft)	
Storage Lanes	
Taper Length (ft)	
Lane Util. Factor	
Ped Bike Factor	
Frt	
Flt Protected	
Satd. Flow (prot)	
Flt Permitted	
Satd. Flow (perm)	
Right Turn on Red	
Satd. Flow (RTOR)	
Link Speed (mph)	
Link Distance (ft)	
Travel Time (s)	
Confl. Peds. (#/hr)	
Peak Hour Factor	
Heavy Vehicles (%)	
Adj. Flow (vph)	
Shared Lane Traffic (%)	
Lane Group Flow (vph)	
Turn Type	
Protected Phases	9
Permitted Phases	
Detector Phase	
Switch Phase	
Minimum Initial (s)	7.0
Minimum Split (s)	28.0
Total Split (s)	28.0
Total Split (%)	23%
Maximum Green (s)	24.0
Yellow Time (s)	3.0
All-Red Time (s)	1.0
Lost Time Adjust (s)	
Total Lost Time (s)	
Lead/Lag	
Lead-Lag Optimize?	
Vehicle Extension (s)	0.2
Recall Mode	None
Walk Time (s)	7.0
Flash Dont Walk (s)	17.0
Pedestrian Calls (#/hr)	0
Act Effect Green (s)	

Lanes, Volumes, Timings
 16: NC 86 (S. Columbia St) & W. Cameron Avenue/E. Cameron Avenue

2020 Existing AM Peak
 Timing Plan: AM Peak



Lane Group	EBL	EBT	EBR	WBL	WBT	WBR	NBL	NBT	NBR	SBL	SBT	SBR
Actuated g/C Ratio	0.14	0.14			0.14		0.40	0.40		0.34		0.34
v/c Ratio	0.14	0.50			0.64		0.20	0.47		0.15		0.75
Control Delay	30.8	35.9			62.4		26.9	29.9		23.8		28.0
Queue Delay	0.0	0.0			0.0		0.0	0.0		0.0		0.0
Total Delay	30.8	35.9			62.4		26.9	29.9		23.8		28.0
LOS	C	D			E		C	C		C		C
Approach Delay		35.3			62.4			29.3				27.5
Approach LOS		D			E			C				C
Queue Length 50th (ft)	8	60			101		54	143		25		114
Queue Length 95th (ft)	m7	m51			146		107	210		m34		135
Internal Link Dist (ft)		193			909			746				901
Turn Bay Length (ft)	100									310		
Base Capacity (vph)	175	361			338		502	982		476		775
Starvation Cap Reductn	0	0			0		0	0		0		0
Spillback Cap Reductn	0	0			0		0	0		0		0
Storage Cap Reductn	0	0			0		0	0		0		0
Reduced v/c Ratio	0.09	0.31			0.40		0.20	0.47		0.15		0.75

Intersection Summary

Area Type: CBD
 Cycle Length: 120
 Actuated Cycle Length: 120
 Offset: 52 (43%), Referenced to phase 2:NBTL, Start of Green
 Natural Cycle: 115
 Control Type: Actuated-Coordinated
 Maximum v/c Ratio: 0.75
 Intersection Signal Delay: 32.1
 Intersection LOS: C
 Intersection Capacity Utilization 65.7%
 ICU Level of Service C
 Analysis Period (min) 15
 m Volume for 95th percentile queue is metered by upstream signal.

Splits and Phases: 16: NC 86 (S. Columbia St) & W. Cameron Avenue/E. Cameron Avenue

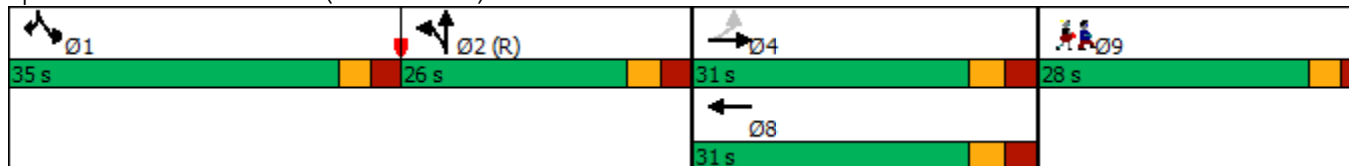

Lane Group	Ø9
Actuated g/C Ratio	
v/c Ratio	
Control Delay	
Queue Delay	
Total Delay	
LOS	
Approach Delay	
Approach LOS	
Queue Length 50th (ft)	
Queue Length 95th (ft)	
Internal Link Dist (ft)	
Turn Bay Length (ft)	
Base Capacity (vph)	
Starvation Cap Reductn	
Spillback Cap Reductn	
Storage Cap Reductn	
Reduced v/c Ratio	
Intersection Summary	

Lanes, Volumes, Timings
 17: Raleigh Street & E. Cameron Avenue/Country Club Road

2020 Existing AM Peak
 Timing Plan: AM Peak



Lane Group	EBL	EBT	EBR	WBL	WBT	WBR	NBL	NBT	NBR	SBL	SBT	SBR
Lane Configurations		↕		↗	↘		↗	↘		↗	↘	
Traffic Volume (vph)	23	43	31	27	139	219	24	44	17	279	145	47
Future Volume (vph)	23	43	31	27	139	219	24	44	17	279	145	47
Ideal Flow (vphpl)	1900	1900	1900	1900	1900	1900	1900	1900	1900	1900	1900	1900
Grade (%)		-3%			3%			-2%			1%	
Storage Length (ft)	0		0	150		0	125		0	75		0
Storage Lanes	0		0	1		0	1		0	1		0
Taper Length (ft)	25			25			25			25		
Lane Util. Factor	1.00	1.00	1.00	1.00	1.00	1.00	1.00	1.00	1.00	1.00	1.00	1.00
Ped Bike Factor		0.98		0.98	0.98		0.91	0.96		0.89	0.95	
Frt		0.957			0.908			0.958			0.963	
Flt Protected		0.988		0.950			0.950			0.950		
Satd. Flow (prot)	0	1493	0	1569	1468	0	1492	1446	0	1569	1509	0
Flt Permitted		0.832		0.575			0.630			0.456		
Satd. Flow (perm)	0	1255	0	935	1468	0	896	1446	0	672	1509	0
Right Turn on Red			No			No			No			No
Satd. Flow (RTOR)												
Link Speed (mph)		25			25			25			25	
Link Distance (ft)		598			651			409			995	
Travel Time (s)		16.3			17.8			11.2			27.1	
Confl. Peds. (#/hr)	3		6	6		3	31		25	25		31
Peak Hour Factor	0.71	0.71	0.71	0.84	0.84	0.84	0.79	0.79	0.79	0.94	0.94	0.94
Heavy Vehicles (%)	8%	8%	8%	2%	2%	2%	10%	10%	10%	3%	3%	3%
Adj. Flow (vph)	32	61	44	32	165	261	30	56	22	297	154	50
Shared Lane Traffic (%)												
Lane Group Flow (vph)	0	137	0	32	426	0	30	78	0	297	204	0
Turn Type	Perm	NA		pm+pt	NA		pm+pt	NA		pm+pt	NA	
Protected Phases		2		1	6		3	8		7	4	
Permitted Phases	2			6			8			4		
Detector Phase	2	2		1	6		3	8		7	4	
Switch Phase												
Minimum Initial (s)	10.0	10.0		7.0	10.0		7.0	7.0		7.0	7.0	
Minimum Split (s)	18.0	18.0		13.0	19.0		13.0	19.0		12.0	16.0	
Total Split (s)	50.0	50.0		20.0	70.0		20.0	35.0		20.0	35.0	
Total Split (%)	40.0%	40.0%		16.0%	56.0%		16.0%	28.0%		16.0%	28.0%	
Maximum Green (s)	43.9	43.9		14.4	64.4		14.7	29.7		15.1	29.9	
Yellow Time (s)	3.3	3.3		3.0	3.1		3.0	3.1		3.0	3.1	
All-Red Time (s)	2.8	2.8		2.6	2.5		2.3	2.2		1.9	2.0	
Lost Time Adjust (s)		-1.1		-0.6	-0.6		-0.3	-0.3		0.1	-0.1	
Total Lost Time (s)		5.0		5.0	5.0		5.0	5.0		5.0	5.0	
Lead/Lag	Lag	Lag		Lead			Lead	Lag		Lead	Lag	
Lead-Lag Optimize?	Yes	Yes		Yes			Yes	Yes		Yes	Yes	
Vehicle Extension (s)	2.0	2.0		2.0	2.0		2.0	2.0		2.0	2.0	
Recall Mode	None	None		None	None		None	None		None	None	
Walk Time (s)	4.0	4.0			4.0			4.0			4.0	
Flash Dont Walk (s)	7.0	7.0			9.0			9.0			6.0	
Pedestrian Calls (#/hr)	0	0			0			0			0	
Act Effect Green (s)		19.8		23.7	23.7		15.3	10.0		24.9	21.0	
Actuated g/C Ratio		0.33		0.40	0.40		0.26	0.17		0.42	0.35	

Lanes, Volumes, Timings
 17: Raleigh Street & E. Cameron Avenue/Country Club Road

2020 Existing AM Peak
 Timing Plan: AM Peak



Lane Group	EBL	EBT	EBR	WBL	WBT	WBR	NBL	NBT	NBR	SBL	SBT	SBR
v/c Ratio		0.33		0.07	0.73		0.10	0.32		0.60	0.39	
Control Delay		22.1		12.4	24.8		14.6	31.7		20.3	21.9	
Queue Delay		0.0		0.0	0.0		0.0	0.0		0.0	0.0	
Total Delay		22.1		12.4	24.8		14.6	31.7		20.3	21.9	
LOS		C		B	C		B	C		C	C	
Approach Delay		22.1			24.0			27.0			21.0	
Approach LOS		C			C			C			C	
Queue Length 50th (ft)		34		7	135		6	27		70	45	
Queue Length 95th (ft)		78		22	231		23	68		#185	161	
Internal Link Dist (ft)		518			571			329			915	
Turn Bay Length (ft)				150			125			75		
Base Capacity (vph)		939		575	1381		529	817		563	853	
Starvation Cap Reductn		0		0	0		0	0		0	0	
Spillback Cap Reductn		0		0	0		0	0		0	0	
Storage Cap Reductn		0		0	0		0	0		0	0	
Reduced v/c Ratio		0.15		0.06	0.31		0.06	0.10		0.53	0.24	

Intersection Summary

Area Type: CBD
 Cycle Length: 125
 Actuated Cycle Length: 59.9
 Natural Cycle: 65
 Control Type: Actuated-Uncoordinated
 Maximum v/c Ratio: 0.73
 Intersection Signal Delay: 22.8
 Intersection LOS: C
 Intersection Capacity Utilization 60.3%
 ICU Level of Service B
 Analysis Period (min) 15
 # 95th percentile volume exceeds capacity, queue may be longer.
 Queue shown is maximum after two cycles.

Splits and Phases: 17: Raleigh Street & E. Cameron Avenue/Country Club Road

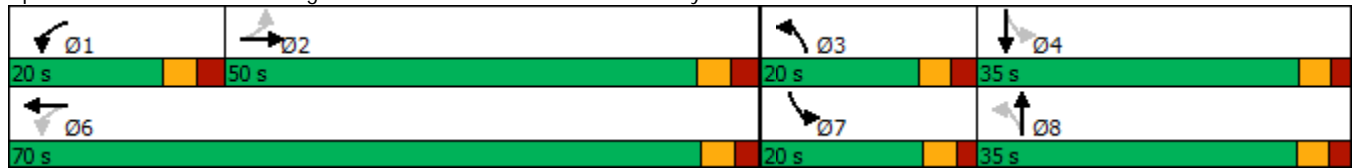

Lanes, Volumes, Timings
1: Church Street & W. Rosemary Street

2020 Existing Noon Peak
Timing Plan: Noon Peak



Lane Group	EBL	EBT	EBR	WBL	WBT	WBR	NBL	NBT	NBR	SBL	SBT	SBR
Lane Configurations		↕			↕			↕			↕	
Traffic Volume (vph)	6	301	28	38	331	24	23	41	54	14	32	10
Future Volume (vph)	6	301	28	38	331	24	23	41	54	14	32	10
Ideal Flow (vphpl)	1900	1900	1900	1900	1900	1900	1900	1900	1900	1900	1900	1900
Lane Width (ft)	12	14	12	12	14	12	12	12	12	12	12	12
Grade (%)		1%			-1%			0%			0%	
Lane Util. Factor	1.00	1.00	1.00	1.00	1.00	1.00	1.00	1.00	1.00	1.00	1.00	1.00
Ped Bike Factor		0.99			0.99			0.92			0.95	
Frt		0.989			0.992			0.938			0.975	
Flt Protected		0.999			0.995			0.990			0.988	
Satd. Flow (prot)	0	1709	0	0	1747	0	0	1479	0	0	1559	0
Flt Permitted		0.994			0.943			0.919			0.917	
Satd. Flow (perm)	0	1699	0	0	1649	0	0	1332	0	0	1421	0
Right Turn on Red			No			No			No			No
Satd. Flow (RTOR)												
Link Speed (mph)		20			20			25			25	
Link Distance (ft)		964			757			379			430	
Travel Time (s)		32.9			25.8			10.3			11.7	
Confl. Peds. (#/hr)	22		24	24		22	75		39	39		75
Peak Hour Factor	0.88	0.88	0.88	0.93	0.93	0.93	0.92	0.92	0.92	0.64	0.64	0.64
Heavy Vehicles (%)	4%	4%	4%	3%	3%	3%	2%	2%	2%	2%	2%	2%
Adj. Flow (vph)	7	342	32	41	356	26	25	45	59	22	50	16
Shared Lane Traffic (%)												
Lane Group Flow (vph)	0	381	0	0	423	0	0	129	0	0	88	0
Turn Type	Perm	NA		Perm	NA		Perm	NA		Perm	NA	
Protected Phases		2			6			8			4	
Permitted Phases	2			6			8			4		
Detector Phase	2	2		6	6		8	8		4	4	
Switch Phase												
Minimum Initial (s)	10.0	10.0		10.0	10.0		7.0	7.0		7.0	7.0	
Minimum Split (s)	19.0	19.0		20.0	20.0		19.0	19.0		19.0	19.0	
Total Split (s)	43.0	43.0		43.0	43.0		22.0	22.0		22.0	22.0	
Total Split (%)	66.2%	66.2%		66.2%	66.2%		33.8%	33.8%		33.8%	33.8%	
Maximum Green (s)	38.5	38.5		38.4	38.4		17.1	17.1		17.1	17.1	
Yellow Time (s)	3.1	3.1		3.1	3.1		3.2	3.2		3.2	3.2	
All-Red Time (s)	1.4	1.4		1.5	1.5		1.7	1.7		1.7	1.7	
Lost Time Adjust (s)		0.5			0.4			0.1			0.1	
Total Lost Time (s)		5.0			5.0			5.0			5.0	
Lead/Lag												
Lead-Lag Optimize?												
Vehicle Extension (s)	3.0	3.0		3.0	3.0		3.0	3.0		3.0	3.0	
Recall Mode	C-Max	C-Max		C-Max	C-Max		None	None		None	None	
Walk Time (s)	4.0	4.0		4.0	4.0		4.0	4.0		4.0	4.0	
Flash Dont Walk (s)	5.0	5.0		6.0	6.0		10.0	10.0		10.0	10.0	
Pedestrian Calls (#/hr)	0	0		0	0		0	0		0	0	
Act Effct Green (s)		47.0			47.0			11.4			11.4	
Actuated g/C Ratio		0.72			0.72			0.18			0.18	
v/c Ratio		0.31			0.36			0.55			0.35	
Control Delay		5.8			3.0			40.3			26.2	

Lanes, Volumes, Timings
 1: Church Street & W. Rosemary Street

2020 Existing Noon Peak
 Timing Plan: Noon Peak



Lane Group	EBL	EBT	EBR	WBL	WBT	WBR	NBL	NBT	NBR	SBL	SBT	SBR
Queue Delay		0.0			0.0			0.0			0.0	
Total Delay		5.8			3.0			40.3			26.2	
LOS		A			A			D			C	
Approach Delay		5.8			3.0			40.3			26.3	
Approach LOS		A			A			D			C	
Queue Length 50th (ft)		52			55			65			31	
Queue Length 95th (ft)		113			39			108			43	
Internal Link Dist (ft)		884			677			299			350	
Turn Bay Length (ft)												
Base Capacity (vph)		1228			1191			348			371	
Starvation Cap Reductn		0			0			0			0	
Spillback Cap Reductn		0			0			0			0	
Storage Cap Reductn		0			0			0			0	
Reduced v/c Ratio		0.31			0.36			0.37			0.24	

Intersection Summary

Area Type:	CBD
Cycle Length:	65
Actuated Cycle Length:	65
Offset:	0 (0%), Referenced to phase 2:EBTL and 6:WBTL, Start of Green
Natural Cycle:	40
Control Type:	Actuated-Coordinated
Maximum v/c Ratio:	0.55
Intersection Signal Delay:	10.8
Intersection LOS:	B
Intersection Capacity Utilization	64.7%
ICU Level of Service	C
Analysis Period (min)	15

Splits and Phases: 1: Church Street & W. Rosemary Street



Lanes, Volumes, Timings

2020 Existing Noon Peak

2: NC 86 (N. Columbia St) & W. Rosemary Street/E. Rosemary Street

Timing Plan: Noon Peak



Lane Group	EBL	EBT	EBR	WBL	WBT	WBR	NBL	NBT	NBR	SBL	SBT	SBR
Lane Configurations												
Traffic Volume (vph)	145	187	47	39	199	49	43	298	97	71	338	168
Future Volume (vph)	145	187	47	39	199	49	43	298	97	71	338	168
Ideal Flow (vphpl)	1900	1900	1900	1900	1900	1900	1900	1900	1900	1900	1900	1900
Lane Width (ft)	9	12	13	12	12	12	9	10	12	12	9	11
Grade (%)		1%			1%			-2%			8%	
Storage Length (ft)	100		0	150		0	75		0	150		400
Storage Lanes	1		0	1		0	1		0	1		1
Taper Length (ft)	25			25			25			25		
Lane Util. Factor	1.00	1.00	1.00	1.00	1.00	1.00	1.00	0.95	0.95	1.00	0.95	1.00
Ped Bike Factor	0.97	0.99		0.96	0.98		0.85	0.88		0.77		0.66
Frt		0.970			0.970			0.963				0.850
Flt Protected	0.950			0.950			0.950			0.950		
Satd. Flow (prot)	1426	1594	0	1585	1589	0	1355	2371	0	1485	2673	1285
Flt Permitted	0.238			0.595			0.497			0.465		
Satd. Flow (perm)	345	1594	0	949	1589	0	599	2371	0	559	2673	850
Right Turn on Red			No			No			No			No
Satd. Flow (RTOR)												
Link Speed (mph)		20			20			25			25	
Link Distance (ft)		757			339			353			476	
Travel Time (s)		25.8			11.6			9.6			13.0	
Confl. Peds. (#/hr)	53		41	41		53	80		129	129		80
Peak Hour Factor	0.88	0.88	0.88	0.85	0.85	0.85	0.98	0.98	0.98	0.86	0.86	0.86
Heavy Vehicles (%)	2%	2%	2%	2%	2%	2%	9%	9%	9%	5%	5%	5%
Adj. Flow (vph)	165	213	53	46	234	58	44	304	99	83	393	195
Shared Lane Traffic (%)												
Lane Group Flow (vph)	165	266	0	46	292	0	44	403	0	83	393	195
Turn Type	pm+pt	NA		Perm	NA		pm+pt	NA		pm+pt	NA	pm+ov
Protected Phases	7	4			8		5	2		1	6	7
Permitted Phases	4			8			2			6		6
Detector Phase	7	4		8	8		5	2		1	6	7
Switch Phase												
Minimum Initial (s)	7.0	7.0		7.0	7.0		7.0	10.0		7.0	10.0	7.0
Minimum Split (s)	13.0	31.0		32.0	32.0		13.0	23.0		13.0	22.0	13.0
Total Split (s)	20.0	63.0		43.0	43.0		15.0	52.0		15.0	52.0	20.0
Total Split (%)	15.4%	48.5%		33.1%	33.1%		11.5%	40.0%		11.5%	40.0%	15.4%
Maximum Green (s)	14.2	57.0		37.0	37.0		9.2	46.2		9.9	46.2	14.2
Yellow Time (s)	3.0	3.2		3.2	3.2		3.0	3.3		3.0	3.3	3.0
All-Red Time (s)	2.8	2.8		2.8	2.8		2.8	2.5		2.1	2.5	2.8
Lost Time Adjust (s)	-0.8	-1.0		-1.0	-1.0		-1.0	-0.8		-0.1	-0.8	-0.8
Total Lost Time (s)	5.0	5.0		5.0	5.0		4.8	5.0		5.0	5.0	5.0
Lead/Lag	Lead			Lag	Lag		Lead	Lag		Lead	Lag	Lead
Lead-Lag Optimize?												
Vehicle Extension (s)	1.0	1.0		1.0	1.0		1.0	3.0		1.0	3.0	1.0
Recall Mode	None	None		None	None		None	C-Max		None	C-Max	None
Walk Time (s)		7.0		7.0	7.0			7.0			7.0	
Flash Dont Walk (s)		18.0		19.0	19.0			10.0			9.0	
Pedestrian Calls (#/hr)		0		0	0			0			0	
Act Effect Green (s)	47.7	47.7		28.5	28.5		67.7	59.3		68.4	61.8	76.0

Lanes, Volumes, Timings

2020 Existing Noon Peak

2: NC 86 (N. Columbia St) & W. Rosemary Street/E. Rosemary Street

Timing Plan: Noon Peak



Lane Group	EBL	EBT	EBR	WBL	WBT	WBR	NBL	NBT	NBR	SBL	SBT	SBR
Actuated g/C Ratio	0.37	0.37		0.22	0.22		0.52	0.46		0.53	0.48	0.58
v/c Ratio	0.68	0.45		0.22	0.84		0.12	0.37		0.24	0.31	0.36
Control Delay	43.1	34.1		46.7	74.0		12.4	14.8		17.5	24.3	17.1
Queue Delay	0.0	0.0		0.0	0.0		0.0	0.4		0.0	0.0	0.0
Total Delay	43.1	34.1		46.7	74.0		12.4	15.2		17.5	24.3	17.1
LOS	D	C		D	E		B	B		B	C	B
Approach Delay		37.5			70.3			14.9			21.4	
Approach LOS		D			E			B			C	
Queue Length 50th (ft)	112	189		35	249		7	37		32	110	73
Queue Length 95th (ft)	124	235		m66	316		m30	136		66	164	133
Internal Link Dist (ft)		677			259			273			396	
Turn Bay Length (ft)	100			150			75			150		400
Base Capacity (vph)	251	711		277	464		380	1081		372	1271	552
Starvation Cap Reductn	0	0		0	0		0	274		0	0	0
Spillback Cap Reductn	0	0		0	0		0	0		0	0	0
Storage Cap Reductn	0	0		0	0		0	0		0	0	0
Reduced v/c Ratio	0.66	0.37		0.17	0.63		0.12	0.50		0.22	0.31	0.35

Intersection Summary

Area Type: CBD
 Cycle Length: 130
 Actuated Cycle Length: 130
 Offset: 34 (26%), Referenced to phase 2:NBTL and 6:SBTL, Start of Green
 Natural Cycle: 85
 Control Type: Actuated-Coordinated
 Maximum v/c Ratio: 0.84
 Intersection Signal Delay: 32.3
 Intersection LOS: C
 Intersection Capacity Utilization 66.3%
 ICU Level of Service C
 Analysis Period (min) 15
 m Volume for 95th percentile queue is metered by upstream signal.

Splits and Phases: 2: NC 86 (N. Columbia St) & W. Rosemary Street/E. Rosemary Street

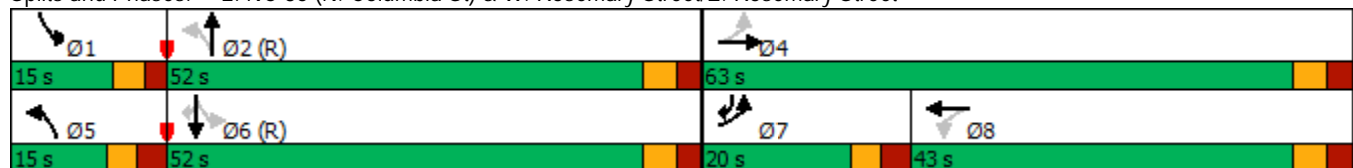

Lanes, Volumes, Timings
6: Henderson Street & E. Rosemary Street

2020 Existing Noon Peak
Timing Plan: Noon Peak



Lane Group	EBL	EBT	EBR	WBL	WBT	WBR	NBL	NBT	NBR	SBL	SBT	SBR
Lane Configurations												
Traffic Volume (vph)	15	193	133	15	203	30	61	29	11	9	29	13
Future Volume (vph)	15	193	133	15	203	30	61	29	11	9	29	13
Ideal Flow (vphpl)	1900	1900	1900	1900	1900	1900	1900	1900	1900	1900	1900	1900
Grade (%)		0%			0%			0%			3%	
Storage Length (ft)	85		0	0		0	0		0	0		0
Storage Lanes	1		0	0		0	0		0	0		0
Taper Length (ft)	25			25			25			25		
Lane Util. Factor	1.00	1.00	1.00	1.00	1.00	1.00	1.00	1.00	1.00	1.00	1.00	1.00
Ped Bike Factor	0.96	0.97			0.99			0.84			0.92	
Frt		0.939			0.984			0.986			0.966	
Flt Protected	0.950				0.997			0.971			0.991	
Satd. Flow (prot)	1593	1526	0	0	1628	0	0	1582	0	0	1470	0
Flt Permitted	0.597				0.976			0.780			0.940	
Satd. Flow (perm)	960	1526	0	0	1591	0	0	1084	0	0	1373	0
Right Turn on Red			No			No			No			No
Satd. Flow (RTOR)												
Link Speed (mph)		20			20			20			20	
Link Distance (ft)		156			1195			366			450	
Travel Time (s)		5.3			40.7			12.5			15.3	
Confl. Peds. (#/hr)	21		19	19		21	106		47	47		106
Peak Hour Factor	0.96	0.96	0.96	0.95	0.95	0.95	0.68	0.68	0.68	0.85	0.85	0.85
Adj. Flow (vph)	16	201	139	16	214	32	90	43	16	11	34	15
Shared Lane Traffic (%)												
Lane Group Flow (vph)	16	340	0	0	262	0	0	149	0	0	60	0
Turn Type	Perm	NA		Perm	NA		Perm	NA		Perm	NA	
Protected Phases		2			2			4			4	
Permitted Phases	2			2			4			4		
Detector Phase	2	2		2	2		4	4		4	4	
Switch Phase												
Minimum Initial (s)	11.0	11.0		11.0	11.0		8.0	8.0		8.0	8.0	
Minimum Split (s)	15.9	15.9		15.9	15.9		17.8	17.8		17.8	17.8	
Total Split (s)	44.0	44.0		44.0	44.0		21.0	21.0		21.0	21.0	
Total Split (%)	67.7%	67.7%		67.7%	67.7%		32.3%	32.3%		32.3%	32.3%	
Maximum Green (s)	39.1	39.1		39.1	39.1		16.2	16.2		16.2	16.2	
Yellow Time (s)	3.3	3.3		3.3	3.3		3.3	3.3		3.3	3.3	
All-Red Time (s)	1.6	1.6		1.6	1.6		1.5	1.5		1.5	1.5	
Lost Time Adjust (s)	0.0	0.0			0.0			0.0			0.0	
Total Lost Time (s)	4.9	4.9			4.9			4.8			4.8	
Lead/Lag												
Lead-Lag Optimize?												
Vehicle Extension (s)	2.0	2.0		2.0	2.0		2.0	2.0		2.0	2.0	
Recall Mode	C-Max	C-Max		C-Max	C-Max		None	None		None	None	
Walk Time (s)	4.0	4.0		4.0	4.0		4.0	4.0		4.0	4.0	
Flash Dont Walk (s)	7.0	7.0		7.0	7.0		9.0	9.0		9.0	9.0	
Pedestrian Calls (#/hr)	0	0		0	0		0	0		0	0	
Act Effct Green (s)	46.1	46.1			46.1			12.7			12.7	
Actuated g/C Ratio	0.71	0.71			0.71			0.20			0.20	
v/c Ratio	0.02	0.31			0.23			0.70			0.22	

Lanes, Volumes, Timings
 6: Henderson Street & E. Rosemary Street

2020 Existing Noon Peak
 Timing Plan: Noon Peak



Lane Group	EBL	EBT	EBR	WBL	WBT	WBR	NBL	NBT	NBR	SBL	SBT	SBR
Control Delay	4.6	6.5			4.6			37.8			22.6	
Queue Delay	0.0	0.0			0.0			0.0			0.0	
Total Delay	4.6	6.5			4.6			37.8			22.6	
LOS	A	A			A			D			C	
Approach Delay		6.4			4.6			37.8			22.6	
Approach LOS		A			A			D			C	
Queue Length 50th (ft)	2	80			36			60			20	
Queue Length 95th (ft)	m6	126			73			34			43	
Internal Link Dist (ft)		76			1115			286			370	
Turn Bay Length (ft)	85											
Base Capacity (vph)	680	1082			1128			270			342	
Starvation Cap Reductn	0	0			0			0			0	
Spillback Cap Reductn	0	0			0			0			0	
Storage Cap Reductn	0	0			0			0			0	
Reduced v/c Ratio	0.02	0.31			0.23			0.55			0.18	

Intersection Summary

Area Type: CBD
 Cycle Length: 65
 Actuated Cycle Length: 65
 Offset: 0 (0%), Referenced to phase 2:EBWB, Start of Green
 Natural Cycle: 40
 Control Type: Actuated-Coordinated
 Maximum v/c Ratio: 0.70
 Intersection Signal Delay: 12.7
 Intersection LOS: B
 Intersection Capacity Utilization 49.4%
 ICU Level of Service A
 Analysis Period (min) 15
 m Volume for 95th percentile queue is metered by upstream signal.

Splits and Phases: 6: Henderson Street & E. Rosemary Street



Lanes, Volumes, Timings
7: Hillsborough Street & E. Rosemary Street

2020 Existing Noon Peak
Timing Plan: Noon Peak



Lane Group	EBL	EBT	EBR	WBL	WBT	WBR	NBL	NBT	NBR	SBL	SBT	SBR
Lane Configurations		↕			↕		↗	↘		↗	↘	
Traffic Volume (vph)	19	88	94	3	50	9	166	146	9	16	184	21
Future Volume (vph)	19	88	94	3	50	9	166	146	9	16	184	21
Ideal Flow (vphpl)	1900	1900	1900	1900	1900	1900	1900	1900	1900	1900	1900	1900
Storage Length (ft)	0		0	0		0	100		0	100		0
Storage Lanes	0		0	0		0	1		0	1		0
Taper Length (ft)	25			25			25			25		
Lane Util. Factor	1.00	1.00	1.00	1.00	1.00	1.00	1.00	1.00	1.00	1.00	1.00	1.00
Ped Bike Factor		0.95			0.98		0.92	1.00		0.99	0.98	
Frt		0.937			0.980			0.991			0.985	
Flt Protected		0.995			0.998		0.950			0.950		
Satd. Flow (prot)	0	1660	0	0	1791	0	1770	1842	0	1719	1750	0
Flt Permitted		0.968			0.981		0.525			0.646		
Satd. Flow (perm)	0	1602	0	0	1756	0	903	1842	0	1154	1750	0
Right Turn on Red			No			No			No			No
Satd. Flow (RTOR)												
Link Speed (mph)		20			20			25			25	
Link Distance (ft)		1195			527			363			726	
Travel Time (s)		40.7			18.0			9.9			19.8	
Confl. Peds. (#/hr)	35		35	35		35	50		5	5		50
Peak Hour Factor	0.93	0.93	0.93	0.78	0.78	0.78	0.88	0.88	0.88	0.91	0.91	0.91
Heavy Vehicles (%)	2%	2%	2%	2%	2%	2%	2%	2%	2%	5%	5%	5%
Adj. Flow (vph)	20	95	101	4	64	12	189	166	10	18	202	23
Shared Lane Traffic (%)												
Lane Group Flow (vph)	0	216	0	0	80	0	189	176	0	18	225	0
Turn Type	Perm	NA		Perm	NA		pm+pt	NA		Perm	NA	
Protected Phases		4			8		5	2			6	
Permitted Phases	4			8			2			6		
Detector Phase	4	4		8	8		5	2		6	6	
Switch Phase												
Minimum Initial (s)	7.0	7.0		7.0	7.0		7.0	10.0		10.0	10.0	
Minimum Split (s)	19.9	19.9		17.0	17.0		13.0	14.8		14.8	14.8	
Total Split (s)	30.0	30.0		30.0	30.0		15.0	35.0		20.0	20.0	
Total Split (%)	46.2%	46.2%		46.2%	46.2%		23.1%	53.8%		30.8%	30.8%	
Maximum Green (s)	25.1	25.1		25.0	25.0		10.2	30.2		15.2	15.2	
Yellow Time (s)	3.0	3.0		3.3	3.3		3.0	3.3		3.1	3.1	
All-Red Time (s)	1.9	1.9		1.7	1.7		1.8	1.5		1.7	1.7	
Lost Time Adjust (s)		0.0			0.0		0.0	0.0		0.0	0.0	
Total Lost Time (s)		4.9			5.0		4.8	4.8		4.8	4.8	
Lead/Lag							Lead			Lag	Lag	
Lead-Lag Optimize?							Yes			Yes	Yes	
Vehicle Extension (s)	2.0	2.0		2.0	2.0		2.0	2.0		2.0	2.0	
Recall Mode	None	None		None	None		None	C-Max		C-Max	C-Max	
Walk Time (s)	4.0	4.0		4.0	4.0			4.0		4.0	4.0	
Flash Dont Walk (s)	11.0	11.0		8.0	8.0			6.0		6.0	6.0	
Pedestrian Calls (#/hr)	0	0		0	0			0		0	0	
Act Effct Green (s)		13.2			13.1		42.1	42.1		29.2	29.2	
Actuated g/C Ratio		0.20			0.20		0.65	0.65		0.45	0.45	
v/c Ratio		0.67			0.23		0.27	0.15		0.03	0.29	

Lanes, Volumes, Timings
 7: Hillsborough Street & E. Rosemary Street

2020 Existing Noon Peak
 Timing Plan: Noon Peak



Lane Group	EBL	EBT	EBR	WBL	WBT	WBR	NBL	NBT	NBR	SBL	SBT	SBR
Control Delay		44.4			21.5		6.4	5.6		13.6	14.5	
Queue Delay		0.0			0.0		0.0	0.0		0.0	0.0	
Total Delay		44.4			21.5		6.4	5.6		13.6	14.5	
LOS		D			C		A	A		B	B	
Approach Delay		44.4			21.5			6.0			14.4	
Approach LOS		D			C			A			B	
Queue Length 50th (ft)		103			27		41	38		4	52	
Queue Length 95th (ft)		140			45		66	61		18	124	
Internal Link Dist (ft)		1115			447			283			646	
Turn Bay Length (ft)							100			100		
Base Capacity (vph)		618			675		722	1194		519	787	
Starvation Cap Reductn		0			0		0	0		0	0	
Spillback Cap Reductn		0			0		0	0		0	0	
Storage Cap Reductn		0			0		0	0		0	0	
Reduced v/c Ratio		0.35			0.12		0.26	0.15		0.03	0.29	

Intersection Summary

Area Type: Other
 Cycle Length: 65
 Actuated Cycle Length: 65
 Offset: 0 (0%), Referenced to phase 2:NBTL and 6:SBTL, Start of Green
 Natural Cycle: 50
 Control Type: Actuated-Coordinated
 Maximum v/c Ratio: 0.67
 Intersection Signal Delay: 18.8
 Intersection LOS: B
 Intersection Capacity Utilization 51.7%
 ICU Level of Service A
 Analysis Period (min) 15

Splits and Phases: 7: Hillsborough Street & E. Rosemary Street

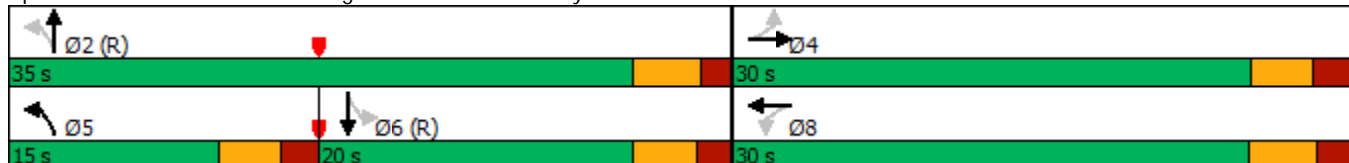

Lanes, Volumes, Timings
 8: Carolina Square Driveway/Church Street & W. Franklin Street

2020 Existing Noon Peak
 Timing Plan: Noon Peak



Lane Group	EBL	EBT	EBR	WBL	WBT	WBR	NBL	NBT	NBR	SBL	SBT	SBR
Lane Configurations												
Traffic Volume (vph)	49	346	25	31	318	67	10	10	22	23	23	51
Future Volume (vph)	49	346	25	31	318	67	10	10	22	23	23	51
Ideal Flow (vphpl)	1900	1900	1900	1900	1900	1900	1900	1900	1900	1900	1900	1900
Lane Width (ft)	10	10	16	10	10	10	12	12	12	12	12	12
Grade (%)		2%			-2%			-4%				-3%
Storage Length (ft)	150		0	200		0	0		100	0		0
Storage Lanes	1		0	1		0	0		1	0		0
Taper Length (ft)	25			25			25			25		
Lane Util. Factor	1.00	0.95	0.95	1.00	0.95	0.95	1.00	1.00	1.00	1.00	1.00	1.00
Ped Bike Factor	0.79	0.97		0.72	0.93			0.92	0.92		0.87	
Frt		0.990			0.974				0.850		0.929	
Flt Protected	0.950			0.950				0.976			0.988	
Satd. Flow (prot)	1443	2759	0	1472	2674	0	0	1669	1454	0	1343	0
Flt Permitted	0.505			0.503				0.860			0.917	
Satd. Flow (perm)	607	2759	0	564	2674	0	0	1346	1339	0	1227	0
Right Turn on Red			No			No			No			No
Satd. Flow (RTOR)												
Link Speed (mph)		20			20			20			25	
Link Distance (ft)		993			755			285			379	
Travel Time (s)		33.9			25.7			9.7			10.3	
Confl. Peds. (#/hr)	150		248	248		150	225		77	77		225
Peak Hour Factor	0.87	0.87	0.87	0.91	0.91	0.91	0.81	0.81	0.81	0.71	0.71	0.71
Heavy Vehicles (%)	4%	4%	4%	4%	4%	4%	2%	2%	2%	5%	5%	5%
Adj. Flow (vph)	56	398	29	34	349	74	12	12	27	32	32	72
Shared Lane Traffic (%)												
Lane Group Flow (vph)	56	427	0	34	423	0	0	24	27	0	136	0
Turn Type	Perm	NA		Perm	NA		Perm	NA	Perm	Perm	NA	
Protected Phases		2			6			8				4
Permitted Phases	2			6			8		8	4		
Detector Phase	2	2		6	6		8	8	8	4	4	
Switch Phase												
Minimum Initial (s)	10.0	10.0		10.0	10.0		7.0	7.0	7.0	7.0	7.0	
Minimum Split (s)	22.0	22.0		19.0	19.0		29.0	29.0	29.0	27.0	27.0	
Total Split (s)	36.0	36.0		36.0	36.0		29.0	29.0	29.0	29.0	29.0	
Total Split (%)	55.4%	55.4%		55.4%	55.4%		44.6%	44.6%	44.6%	44.6%	44.6%	
Maximum Green (s)	30.4	30.4		30.4	30.4		22.7	22.7	22.7	23.0	23.0	
Yellow Time (s)	3.3	3.3		3.3	3.3		3.1	3.1	3.1	3.4	3.4	
All-Red Time (s)	2.3	2.3		2.3	2.3		3.2	3.2	3.2	2.6	2.6	
Lost Time Adjust (s)	-0.6	-0.6		-0.6	-0.6		-1.3	-1.3	-1.3	-1.0	-1.0	
Total Lost Time (s)	5.0	5.0		5.0	5.0		5.0	5.0	5.0	5.0	5.0	
Lead/Lag												
Lead-Lag Optimize?												
Vehicle Extension (s)	3.0	3.0		3.0	3.0		2.0	2.0	2.0	2.0	2.0	
Recall Mode	C-Max	C-Max		C-Max	C-Max		None	None	None	None	None	
Walk Time (s)	7.0	7.0		7.0	7.0		7.0	7.0	7.0	7.0	7.0	
Flash Dont Walk (s)	9.0	9.0		6.0	6.0		15.0	15.0	15.0	14.0	14.0	
Pedestrian Calls (#/hr)	0	0		0	0		0	0	0	0	0	
Act Effect Green (s)	45.9	45.9		45.9	45.9		12.8	12.8	12.8	12.8	12.7	

Lanes, Volumes, Timings
 8: Carolina Square Driveway/Church Street & W. Franklin Street

2020 Existing Noon Peak
 Timing Plan: Noon Peak



Lane Group	EBL	EBT	EBR	WBL	WBT	WBR	NBL	NBT	NBR	SBL	SBT	SBR
Actuated g/C Ratio	0.71	0.71		0.71	0.71			0.20	0.20			0.20
v/c Ratio	0.13	0.22		0.09	0.22			0.09	0.10			0.57
Control Delay	6.7	5.4		6.1	6.8			19.9	20.2			38.5
Queue Delay	0.0	0.0		0.0	0.0			0.0	0.0			0.0
Total Delay	6.7	5.4		6.1	6.8			19.9	20.2			38.5
LOS	A	A		A	A			B	C			D
Approach Delay		5.6			6.8			20.1				38.5
Approach LOS		A			A			C				D
Queue Length 50th (ft)	7	30		15	106			8	9			60
Queue Length 95th (ft)	25	61		m10	41			20	22			67
Internal Link Dist (ft)		913			675			205				299
Turn Bay Length (ft)	150			200					100			
Base Capacity (vph)	428	1948		398	1888			496	494			453
Starvation Cap Reductn	0	0		0	0			0	0			0
Spillback Cap Reductn	0	0		0	0			0	0			0
Storage Cap Reductn	0	0		0	0			0	0			0
Reduced v/c Ratio	0.13	0.22		0.09	0.22			0.05	0.05			0.30

Intersection Summary

Area Type: CBD
 Cycle Length: 65
 Actuated Cycle Length: 65
 Offset: 0 (0%), Referenced to phase 2:EBTL and 6:WBTL, Start of Green
 Natural Cycle: 55
 Control Type: Actuated-Coordinated
 Maximum v/c Ratio: 0.57
 Intersection Signal Delay: 10.7
 Intersection LOS: B
 Intersection Capacity Utilization 60.8%
 ICU Level of Service B
 Analysis Period (min) 15
 m Volume for 95th percentile queue is metered by upstream signal.





















Splits and Phases: 8: Carolina Square Driveway/Church Street & W. Franklin Street



Lanes, Volumes, Timings

2020 Existing Noon Peak

9: NC 86 (S. Columbia St)/NC 86 (N. Columbia St) & W. Franklin Street/E. Franklin Street

												
Lane Group	EBL	EBT	EBR	WBL	WBT	WBR	NBL	NBT	NBR	SBL	SBT	SBR
Lane Configurations												
Traffic Volume (vph)	95	292	45	80	302	85	60	266	88	49	288	80
Future Volume (vph)	95	292	45	80	302	85	60	266	88	49	288	80
Ideal Flow (vphpl)	1900	1900	1900	1900	1900	1900	1900	1900	1900	1900	1900	1900
Lane Width (ft)	9	12	13	10	10	13	9	10	10	9	9	11
Grade (%)		3%			1%			-2%			3%	
Storage Length (ft)	250		0	125		0	475		0	125		0
Storage Lanes	1		0	1		0	1		0	1		0
Taper Length (ft)	25			25			25			25		
Lane Util. Factor	1.00	0.95	0.95	1.00	0.95	0.95	1.00	0.95	0.95	1.00	0.95	0.95
Ped Bike Factor	0.82	0.96		0.82	0.93		0.89	0.91		0.79	0.95	
Frt		0.980			0.967			0.963			0.967	
Flt Protected	0.950			0.950			0.950			0.950		
Satd. Flow (prot)	1372	2854	0	1437	2574	0	1342	2441	0	1346	2481	0
Flt Permitted	0.950			0.950			0.950			0.950		
Satd. Flow (perm)	1128	2854	0	1174	2574	0	1190	2441	0	1065	2481	0
Right Turn on Red			No			No			No			No
Satd. Flow (RTOR)												
Link Speed (mph)		20			20			25			25	
Link Distance (ft)		755			941			981			353	
Travel Time (s)		25.7			32.1			26.8			9.6	
Confl. Peds. (#/hr)	251		248	248		251	117		321	321		117
Peak Hour Factor	0.80	0.80	0.80	0.87	0.87	0.87	0.93	0.93	0.93	0.85	0.85	0.85
Heavy Vehicles (%)	5%	5%	5%	5%	5%	5%	10%	10%	10%	7%	7%	7%
Adj. Flow (vph)	119	365	56	92	347	98	65	286	95	58	339	94
Shared Lane Traffic (%)												
Lane Group Flow (vph)	119	421	0	92	445	0	65	381	0	58	433	0
Turn Type	Prot	NA		Prot	NA		Prot	NA		Prot	NA	
Protected Phases	5	2		1	6		3	8		7	4	
Permitted Phases												
Detector Phase	5	2		1	6		3	8		7	4	
Switch Phase												
Minimum Initial (s)	7.0	10.0		7.0	10.0		7.0	7.0		7.0	7.0	
Minimum Split (s)	15.0	28.2		15.0	28.2		15.0	28.0		15.0	28.1	
Total Split (s)	25.0	32.0		25.0	32.0		25.0	48.0		25.0	48.0	
Total Split (%)	19.2%	24.6%		19.2%	24.6%		19.2%	36.9%		19.2%	36.9%	
Maximum Green (s)	19.6	25.8		19.1	25.8		19.1	42.1		19.1	42.3	
Yellow Time (s)	3.0	3.0		3.0	3.0		3.0	3.3		3.0	3.1	
All-Red Time (s)	2.4	3.2		2.9	3.2		2.9	2.6		2.9	2.6	
Lost Time Adjust (s)	-0.4	-1.2		-0.9	-1.2		-0.9	-0.9		-0.9	-0.7	
Total Lost Time (s)	5.0	5.0		5.0	5.0		5.0	5.0		5.0	5.0	
Lead/Lag	Lead	Lag		Lead	Lag		Lead	Lag		Lead	Lag	
Lead-Lag Optimize?	Yes	Yes		Yes	Yes		Yes	Yes		Yes	Yes	
Vehicle Extension (s)	1.0	3.0		1.0	3.0		1.0	2.0		1.0	2.0	
Recall Mode	None	C-Max		None	C-Max		None	Ped		None	Ped	
Walk Time (s)		7.0			7.0			7.0			7.0	
Flash Dont Walk (s)		15.0			15.0			15.0			15.0	
Pedestrian Calls (#/hr)		0			0			0			0	
Act Effect Green (s)	15.1	60.1		12.9	57.8		11.1	29.2		10.5	28.5	

Lanes, Volumes, Timings

2020 Existing Noon Peak

9: NC 86 (S. Columbia St)/NC 86 (N. Columbia St) & W. Franklin Street/E. Franklin Street



Lane Group	EBL	EBT	EBR	WBL	WBT	WBR	NBL	NBT	NBR	SBL	SBT	SBR
Actuated g/C Ratio	0.12	0.46		0.10	0.44		0.09	0.22		0.08	0.22	
v/c Ratio	0.75	0.32		0.65	0.39		0.57	0.70		0.54	0.80	
Control Delay	86.8	26.7		62.1	28.4		73.7	37.6		91.7	41.3	
Queue Delay	0.0	0.0		0.0	0.0		0.0	0.0		0.0	0.0	
Total Delay	86.8	26.7		62.1	28.4		73.7	37.6		91.7	41.3	
LOS	F	C		E	C		E	D		F	D	
Approach Delay		39.9			34.2			42.8			47.3	
Approach LOS		D			C			D			D	
Queue Length 50th (ft)	100	105		57	151		31	161		52	93	
Queue Length 95th (ft)	134	189		89	236		80	204		94	93	
Internal Link Dist (ft)		675			861			901			273	
Turn Bay Length (ft)	250			125			475			125		
Base Capacity (vph)	215	1318		221	1145		206	807		207	820	
Starvation Cap Reductn	0	0		0	0		0	0		0	11	
Spillback Cap Reductn	0	0		0	0		0	0		0	0	
Storage Cap Reductn	0	0		0	0		0	0		0	0	
Reduced v/c Ratio	0.55	0.32		0.42	0.39		0.32	0.47		0.28	0.54	

Intersection Summary

Area Type: CBD
 Cycle Length: 130
 Actuated Cycle Length: 130
 Offset: 104 (80%), Referenced to phase 2:EBT and 6:WBT, Start of Green
 Natural Cycle: 90
 Control Type: Actuated-Coordinated
 Maximum v/c Ratio: 0.80
 Intersection Signal Delay: 40.8
 Intersection LOS: D
 Intersection Capacity Utilization 65.0%
 ICU Level of Service C
 Analysis Period (min) 15

Splits and Phases: 9: NC 86 (S. Columbia St)/NC 86 (N. Columbia St) & W. Franklin Street/E. Franklin Street

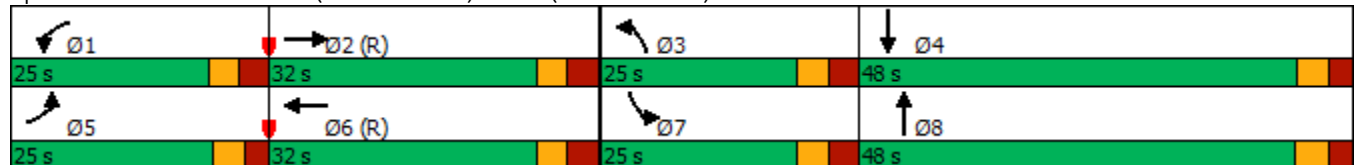

Lanes, Volumes, Timings
 10: E. Franklin Street & Henderson Street

2020 Existing Noon Peak
 Timing Plan: Noon Peak



Lane Group	EBL	EBT	WBT	WBR	SBL	SBR
Lane Configurations		↕↕	↕↔		↔↕	
Traffic Volume (vph)	46	370	407	60	100	78
Future Volume (vph)	46	370	407	60	100	78
Ideal Flow (vphpl)	1900	1900	1900	1900	1900	1900
Lane Width (ft)	10	13	10	10	11	11
Grade (%)		-2%	2%		3%	
Lane Util. Factor	0.95	0.95	0.95	0.95	1.00	1.00
Ped Bike Factor		0.99	0.97		0.79	
Frt			0.981		0.941	
Flt Protected		0.995			0.973	
Satd. Flow (prot)	0	3213	2733	0	1255	0
Flt Permitted		0.864			0.973	
Satd. Flow (perm)	0	2751	2733	0	1161	0
Right Turn on Red				No		No
Satd. Flow (RTOR)						
Link Speed (mph)		20	20		20	
Link Distance (ft)		941	1200		366	
Travel Time (s)		32.1	40.9		12.5	
Confl. Peds. (#/hr)	119			119	130	370
Peak Hour Factor	0.95	0.95	0.92	0.92	0.87	0.87
Heavy Vehicles (%)	5%	5%	4%	4%	2%	2%
Parking (#/hr)						0
Adj. Flow (vph)	48	389	442	65	115	90
Shared Lane Traffic (%)						
Lane Group Flow (vph)	0	437	507	0	205	0
Turn Type	Perm	NA	NA		Prot	
Protected Phases		2	6		4	
Permitted Phases	2					
Detector Phase	2	2	6		4	
Switch Phase						
Minimum Initial (s)	10.0	10.0	10.0		7.0	
Minimum Split (s)	17.0	17.0	22.0		25.0	
Total Split (s)	40.0	40.0	40.0		25.0	
Total Split (%)	61.5%	61.5%	61.5%		38.5%	
Maximum Green (s)	33.8	33.8	33.9		19.9	
Yellow Time (s)	3.0	3.0	3.0		3.0	
All-Red Time (s)	3.2	3.2	3.1		2.1	
Lost Time Adjust (s)		-1.2	-1.1		-0.1	
Total Lost Time (s)		5.0	5.0		5.0	
Lead/Lag						
Lead-Lag Optimize?						
Vehicle Extension (s)	2.0	2.0	2.0		1.0	
Recall Mode	C-Max	C-Max	C-Max		None	
Walk Time (s)			7.0		7.0	
Flash Dont Walk (s)			8.0		12.0	
Pedestrian Calls (#/hr)			0		0	
Act Effct Green (s)		41.1	41.1		13.9	
Actuated g/C Ratio		0.63	0.63		0.21	
v/c Ratio		0.25	0.29		0.76	

Lanes, Volumes, Timings
 10: E. Franklin Street & Henderson Street

2020 Existing Noon Peak
 Timing Plan: Noon Peak

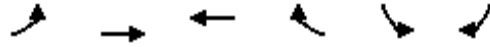

Lane Group	EBL	EBT	WBT	WBR	SBL	SBR
Control Delay		6.3	9.2		35.0	
Queue Delay		0.0	0.0		0.0	
Total Delay		6.3	9.2		35.0	
LOS		A	A		D	
Approach Delay		6.3	9.2		35.0	
Approach LOS		A	A		D	
Queue Length 50th (ft)		20	100		46	
Queue Length 95th (ft)		119	157		71	
Internal Link Dist (ft)		861	1120		286	
Turn Bay Length (ft)						
Base Capacity (vph)		1737	1726		386	
Starvation Cap Reductn		0	0		0	
Spillback Cap Reductn		0	0		0	
Storage Cap Reductn		0	0		0	
Reduced v/c Ratio		0.25	0.29		0.53	

Intersection Summary	
Area Type:	CBD
Cycle Length:	65
Actuated Cycle Length:	65
Offset:	32 (49%), Referenced to phase 2:EBTL and 6:WBT, Start of Green
Natural Cycle:	50
Control Type:	Actuated-Coordinated
Maximum v/c Ratio:	0.76
Intersection Signal Delay:	12.7
Intersection LOS:	B
Intersection Capacity Utilization	56.6%
ICU Level of Service	B
Analysis Period (min)	15

Splits and Phases: 10: E. Franklin Street & Henderson Street

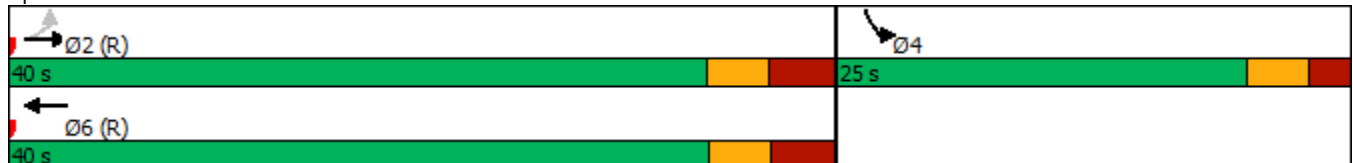

Lanes, Volumes, Timings
 11: Raleigh Street/Hillsborough Street & E. Franklin Street

2020 Existing Noon Peak
 Timing Plan: Noon Peak



Lane Group	EBL	EBT	EBR	WBL	WBT	WBR	NBL	NBT	NBR	SBL	SBT	SBR
Lane Configurations												
Traffic Volume (vph)	54	326	149	40	367	126	84	149	23	57	182	23
Future Volume (vph)	54	326	149	40	367	126	84	149	23	57	182	23
Ideal Flow (vphpl)	1900	1900	1900	1900	1900	1900	1900	1900	1900	1900	1900	1900
Lane Width (ft)	9	9	10	9	10	11	12	12	12	10	10	10
Grade (%)		1%			-2%			1%			1%	
Storage Length (ft)	75		0	75		0	0		0	100		0
Storage Lanes	1		0	1		0	0		0	1		0
Taper Length (ft)	25			25			25			25		
Lane Util. Factor	1.00	0.95	0.95	1.00	0.95	0.95	1.00	1.00	1.00	1.00	1.00	1.00
Ped Bike Factor	0.97	0.98		0.99	0.98			0.96		0.97	0.98	
Frt		0.953			0.962			0.988			0.983	
Flt Protected	0.950			0.950				0.984		0.950		
Satd. Flow (prot)	1539	2886	0	1593	3111	0	0	1791	0	1612	1635	0
Flt Permitted	0.433			0.443				0.605		0.479		
Satd. Flow (perm)	682	2886	0	732	3111	0	0	1068	0	787	1635	0
Right Turn on Red			No			No			No			No
Satd. Flow (RTOR)												
Link Speed (mph)		20			30			25			25	
Link Distance (ft)		1200			1013			995			363	
Travel Time (s)		40.9			23.0			27.1			9.9	
Confl. Peds. (#/hr)	50		25	25		50	93		33	33		93
Peak Hour Factor	0.91	0.91	0.91	0.91	0.91	0.91	0.94	0.94	0.94	0.90	0.90	0.90
Heavy Vehicles (%)	5%	5%	5%	3%	3%	3%	2%	2%	2%	4%	4%	4%
Adj. Flow (vph)	59	358	164	44	403	138	89	159	24	63	202	26
Shared Lane Traffic (%)												
Lane Group Flow (vph)	59	522	0	44	541	0	0	272	0	63	228	0
Turn Type	Perm	NA		Perm	NA		pm+pt	NA		D.Pm	NA	
Protected Phases		2			6		7	4				8
Permitted Phases	2			6			4			4		
Detector Phase	2	2		6	6		7	4		4		8
Switch Phase												
Minimum Initial (s)	10.0	10.0		10.0	10.0		7.0	7.0		7.0	7.0	
Minimum Split (s)	16.0	16.0		16.0	16.0		14.0	30.0		30.0	29.0	
Total Split (s)	55.0	55.0		55.0	55.0		14.0	75.0		75.0	61.0	
Total Split (%)	42.3%	42.3%		42.3%	42.3%		10.8%	57.7%		57.7%	46.9%	
Maximum Green (s)	49.7	49.7		49.7	49.7		7.8	68.6		68.6	54.6	
Yellow Time (s)	3.0	3.0		3.0	3.0		3.0	3.1		3.1	3.1	
All-Red Time (s)	2.3	2.3		2.3	2.3		3.2	3.3		3.3	3.3	
Lost Time Adjust (s)	-0.3	-0.3		-0.3	-0.3			-1.4		-1.4	-1.4	
Total Lost Time (s)	5.0	5.0		5.0	5.0			5.0		5.0	5.0	
Lead/Lag							Lead				Lag	
Lead-Lag Optimize?							Yes				Yes	
Vehicle Extension (s)	3.0	3.0		3.0	3.0		3.0	2.0		2.0	2.0	
Recall Mode	C-Max	C-Max		C-Max	C-Max		None	None		None	None	
Walk Time (s)								7.0		7.0	7.0	
Flash Dont Walk (s)								16.0		16.0	15.0	
Pedestrian Calls (#/hr)								0		0	0	
Act Effect Green (s)	86.0	86.0		86.0	86.0			34.0		34.0	34.0	

Lanes, Volumes, Timings
 11: Raleigh Street/Hillsborough Street & E. Franklin Street

2020 Existing Noon Peak
 Timing Plan: Noon Peak



Lane Group	EBL	EBT	EBR	WBL	WBT	WBR	NBL	NBT	NBR	SBL	SBT	SBR
Actuated g/C Ratio	0.66	0.66		0.66	0.66			0.26		0.26	0.26	
v/c Ratio	0.13	0.27		0.09	0.26			0.98		0.31	0.53	
Control Delay	12.9	11.8		11.0	10.5			94.9		39.8	44.8	
Queue Delay	0.0	0.0		0.0	0.0			0.0		0.0	0.2	
Total Delay	12.9	11.8		11.0	10.5			94.9		39.8	44.9	
LOS	B	B		B	B			F		D	D	
Approach Delay		11.9			10.6			94.9			43.8	
Approach LOS		B			B			F			D	
Queue Length 50th (ft)	16	77		12	91			228		39	177	
Queue Length 95th (ft)	m58	184		36	156			311		64	173	
Internal Link Dist (ft)		1120			933			915			283	
Turn Bay Length (ft)	75			75						100		
Base Capacity (vph)	451	1910		484	2059			575		423	704	
Starvation Cap Reductn	0	0		0	0			0		0	106	
Spillback Cap Reductn	0	0		0	0			0		0	0	
Storage Cap Reductn	0	0		0	0			0		0	0	
Reduced v/c Ratio	0.13	0.27		0.09	0.26			0.47		0.15	0.38	

Intersection Summary

Area Type: Other
 Cycle Length: 130
 Actuated Cycle Length: 130
 Offset: 0 (0%), Referenced to phase 2:EBTL and 6:WBTL, Start of Green
 Natural Cycle: 60
 Control Type: Actuated-Coordinated
 Maximum v/c Ratio: 0.98
 Intersection Signal Delay: 29.9
 Intersection LOS: C
 Intersection Capacity Utilization 75.7%
 ICU Level of Service D
 Analysis Period (min) 15
 m Volume for 95th percentile queue is metered by upstream signal.

Splits and Phases: 11: Raleigh Street/Hillsborough Street & E. Franklin Street

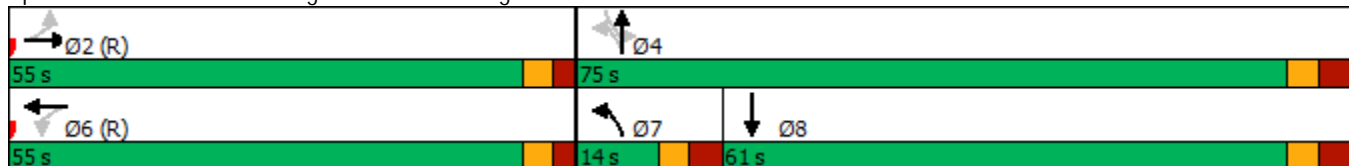

Lanes, Volumes, Timings

2020 Existing Noon Peak

14: NC 86 (MLK Jr. Blvd) & Longview Street/Mill Creek Apts Driveway

Timing Plan: Noon Peak

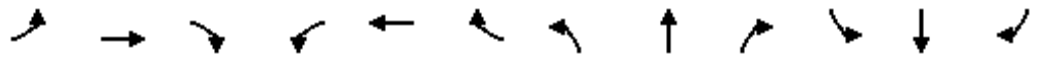

Lane Group	EBL	EBT	EBR	WBL	WBT	WBR	NBL	NBT	NBR	SBL	SBT	SBR
Lane Configurations		↕			↕		↕	↕		↕	↕	
Traffic Volume (vph)	36	0	19	4	0	2	7	469	8	1	513	34
Future Volume (vph)	36	0	19	4	0	2	7	469	8	1	513	34
Ideal Flow (vphpl)	1900	1900	1900	1900	1900	1900	1900	1900	1900	1900	1900	1900
Grade (%)		-6%			1%			2%			-4%	
Storage Length (ft)	0		0	0		0	225		0	250		0
Storage Lanes	0		0	0		0	1		0	1		0
Taper Length (ft)	25			25			25			25		
Lane Util. Factor	1.00	1.00	1.00	1.00	1.00	1.00	1.00	0.95	0.95	1.00	0.95	0.95
Ped Bike Factor		0.99			0.98		0.99	1.00		0.98	1.00	
Frt		0.953			0.955			0.997			0.991	
Flt Protected		0.968			0.968		0.950			0.950		
Satd. Flow (prot)	0	1717	0	0	1706	0	1670	3327	0	1753	3467	0
Flt Permitted		0.796			0.756		0.425			0.453		
Satd. Flow (perm)	0	1411	0	0	1317	0	742	3327	0	821	3467	0
Right Turn on Red			No			No			No			No
Satd. Flow (RTOR)												
Link Speed (mph)		25			20			35			35	
Link Distance (ft)		451			338			2108			784	
Travel Time (s)		12.3			11.5			41.1			15.3	
Confl. Peds. (#/hr)	1		19	19		1	7		15	15		7
Peak Hour Factor	0.76	0.76	0.76	0.50	0.50	0.50	0.89	0.89	0.89	0.91	0.91	0.91
Heavy Vehicles (%)	4%	4%	4%	2%	2%	2%	7%	7%	7%	5%	5%	5%
Adj. Flow (vph)	47	0	25	8	0	4	8	527	9	1	564	37
Shared Lane Traffic (%)												
Lane Group Flow (vph)	0	72	0	0	12	0	8	536	0	1	601	0
Turn Type	Perm	NA		Perm	NA		Perm	NA		Perm	NA	
Protected Phases		4			8			2			6	
Permitted Phases	4			8			2			6		
Detector Phase	4	4		8	8		2	2		6	6	
Switch Phase												
Minimum Initial (s)	7.0	7.0		7.0	7.0		12.0	12.0		12.0	12.0	
Minimum Split (s)	31.0	31.0		14.0	14.0		28.0	28.0		28.0	28.0	
Total Split (s)	20.0	20.0		20.0	20.0		60.0	60.0		60.0	60.0	
Total Split (%)	25.0%	25.0%		25.0%	25.0%		75.0%	75.0%		75.0%	75.0%	
Maximum Green (s)	14.0	14.0		13.9	13.9		54.0	54.0		54.5	54.5	
Yellow Time (s)	3.5	3.5		3.0	3.0		4.5	4.5		4.0	4.0	
All-Red Time (s)	2.5	2.5		3.1	3.1		1.5	1.5		1.5	1.5	
Lost Time Adjust (s)		-1.0			-1.0		-1.0	-1.0		-0.5	-0.5	
Total Lost Time (s)		5.0			5.1		5.0	5.0		5.0	5.0	
Lead/Lag												
Lead-Lag Optimize?												
Vehicle Extension (s)	3.0	3.0		3.0	3.0		3.0	3.0		3.0	3.0	
Recall Mode	None	None		None	None		Min	Min		Min	Min	
Walk Time (s)	7.0	7.0					7.0	7.0		7.0	7.0	
Flash Dont Walk (s)	17.0	17.0					9.0	9.0		9.0	9.0	
Pedestrian Calls (#/hr)	0	0					0	0		0	0	
Act Effct Green (s)		8.6			8.5		24.0	24.0		24.0	24.0	
Actuated g/C Ratio		0.25			0.24		0.69	0.69		0.69	0.69	

Lanes, Volumes, Timings

2020 Existing Noon Peak

14: NC 86 (MLK Jr. Blvd) & Longview Street/Mill Creek Apts Driveway

Timing Plan: Noon Peak

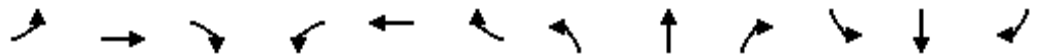

Lane Group	EBL	EBT	EBR	WBL	WBT	WBR	NBL	NBT	NBR	SBL	SBT	SBR
v/c Ratio		0.21			0.04		0.02	0.24		0.00	0.25	
Control Delay		12.3			10.3		5.6	5.0		5.0	5.1	
Queue Delay		0.0			0.0		0.0	0.0		0.0	0.0	
Total Delay		12.3			10.3		5.6	5.0		5.0	5.1	
LOS		B			B		A	A		A	A	
Approach Delay		12.3			10.3			5.0			5.1	
Approach LOS		B			B			A			A	
Queue Length 50th (ft)		14			2		1	28		0	32	
Queue Length 95th (ft)		25			5		5	53		1	60	
Internal Link Dist (ft)		371			258			2028			704	
Turn Bay Length (ft)							225			250		
Base Capacity (vph)		609			564		742	3327		821	3467	
Starvation Cap Reductn		0			0		0	0		0	0	
Spillback Cap Reductn		0			0		0	0		0	0	
Storage Cap Reductn		0			0		0	0		0	0	
Reduced v/c Ratio		0.12			0.02		0.01	0.16		0.00	0.17	

Intersection Summary

Area Type:	Other
Cycle Length:	80
Actuated Cycle Length:	35
Natural Cycle:	60
Control Type:	Actuated-Uncoordinated
Maximum v/c Ratio:	0.25
Intersection Signal Delay:	5.5
Intersection LOS:	A
Intersection Capacity Utilization:	36.1%
ICU Level of Service:	A
Analysis Period (min):	15

Splits and Phases: 14: NC 86 (MLK Jr. Blvd) & Longview Street/Mill Creek Apts Driveway



Lanes, Volumes, Timings
 15: NC 86 (Pittsboro St) & W. Cameron Avenue

2020 Existing Noon Peak
 Timing Plan: Noon Peak



Lane Group	EBT	EBR	WBL	WBT	NBL	NBR	Ø1	Ø4
Lane Configurations	↻		↻↻	↻				
Traffic Volume (vph)	74	149	419	210	0	0		
Future Volume (vph)	74	149	419	210	0	0		
Ideal Flow (vphpl)	1900	1900	1900	1900	1900	1900		
Lane Width (ft)	12	12	11	12	12	12		
Grade (%)	3%			-3%	0%			
Storage Length (ft)		0	75		0	0		
Storage Lanes		0	0		0	0		
Taper Length (ft)			25		25			
Lane Util. Factor	1.00	1.00	0.97	1.00	1.00	1.00		
Ped Bike Factor	0.77		0.64					
Frt	0.910							
Flt Protected			0.950					
Satd. Flow (prot)	1164	0	2837	1592	0	0		
Flt Permitted			0.950					
Satd. Flow (perm)	1164	0	1824	1592	0	0		
Right Turn on Red		No				No		
Satd. Flow (RTOR)								
Link Speed (mph)	25			25	25			
Link Distance (ft)	391			120	794			
Travel Time (s)	30.0			10.7	21.7			
Confl. Peds. (#/hr)		129	129					
Peak Hour Factor	0.71	0.71	0.93	0.93	0.90	0.90		
Heavy Vehicles (%)	2%	2%	9%	9%	2%	2%		
Adj. Flow (vph)	104	210	451	226	0	0		
Shared Lane Traffic (%)								
Lane Group Flow (vph)	314	0	451	226	0	0		
Turn Type	NA		Prot	NA				
Protected Phases	2		1 4	6			1	4
Permitted Phases								
Detector Phase	2		1 4	6				
Switch Phase								
Minimum Initial (s)	10.0			10.0			7.0	7.0
Minimum Split (s)	20.0			20.0			20.0	20.0
Total Split (s)	64.0			109.0			45.0	21.0
Total Split (%)	49.2%			83.8%			35%	16%
Maximum Green (s)	58.9			104.0			39.9	17.0
Yellow Time (s)	3.0			3.3			3.0	3.0
All-Red Time (s)	2.1			1.7			2.1	1.0
Lost Time Adjust (s)	-0.1			0.0				
Total Lost Time (s)	5.0			5.0				
Lead/Lag	Lag						Lead	
Lead-Lag Optimize?								
Vehicle Extension (s)	1.0			1.0			4.0	0.2
Recall Mode	None			C-Max			C-Max	None
Walk Time (s)	7.0							7.0
Flash Dont Walk (s)	4.0							9.0
Pedestrian Calls (#/hr)	0							0
Act Effect Green (s)	59.0		61.0	106.1				

Lanes, Volumes, Timings
 15: NC 86 (Pittsboro St) & W. Cameron Avenue

2020 Existing Noon Peak
 Timing Plan: Noon Peak



Lane Group	EBT	EBR	WBL	WBT	NBL	NBR	Ø1	Ø4
Actuated g/C Ratio	0.45		0.47	0.82				
v/c Ratio	0.59		0.34	0.17				
Control Delay	32.3		22.2	4.6				
Queue Delay	0.0		0.0	0.6				
Total Delay	32.3		22.2	5.1				
LOS	C		C	A				
Approach Delay	32.3			16.5				
Approach LOS	C			B				
Queue Length 50th (ft)	194		160	26				
Queue Length 95th (ft)	210		196	m95				
Internal Link Dist (ft)	311			40	714			
Turn Bay Length (ft)			75					
Base Capacity (vph)	528		1307	1299				
Starvation Cap Reductn	0		0	741				
Spillback Cap Reductn	0		0	0				
Storage Cap Reductn	0		0	0				
Reduced v/c Ratio	0.59		0.35	0.41				

Intersection Summary

Area Type: CBD
 Cycle Length: 130
 Actuated Cycle Length: 130
 Offset: 0 (0%), Referenced to phase 1:WBL and 6:WBT, Start of Green
 Natural Cycle: 60
 Control Type: Actuated-Coordinated
 Maximum v/c Ratio: 0.59
 Intersection Signal Delay: 21.5 Intersection LOS: C
 Intersection Capacity Utilization 40.6% ICU Level of Service A
 Analysis Period (min) 15
 m Volume for 95th percentile queue is metered by upstream signal.

Splits and Phases: 15: NC 86 (Pittsboro St) & W. Cameron Avenue

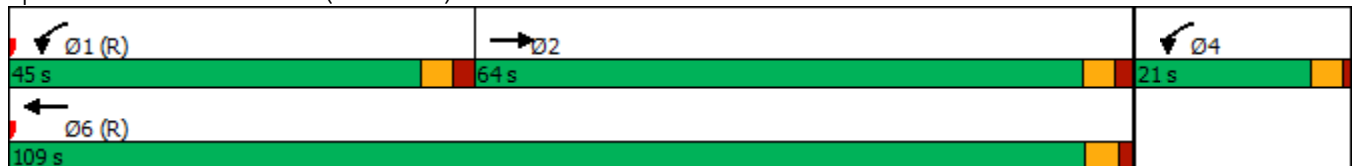

Lanes, Volumes, Timings

2020 Existing Noon Peak

16: NC 86 (S. Columbia St) & W. Cameron Avenue/E. Cameron Avenue

Timing Plan: Noon Peak

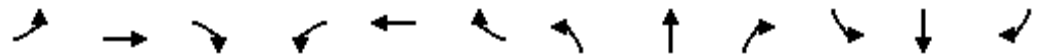

Lane Group	EBL	EBT	EBR	WBL	WBT	WBR	NBL	NBT	NBR	SBL	SBT	SBR
Lane Configurations												
Traffic Volume (vph)	17	50	0	0	88	36	166	348	26	42	0	374
Future Volume (vph)	17	50	0	0	88	36	166	348	26	42	0	374
Ideal Flow (vphpl)	1900	1900	1900	1900	1900	1900	1900	1900	1900	1900	1900	1900
Lane Width (ft)	11	12	12	12	12	12	10	10	10	11	11	12
Grade (%)		1%			-1%			1%			2%	
Storage Length (ft)	100		0	0		0	0		0	310		0
Storage Lanes	1		0	0		0	1		0	1		2
Taper Length (ft)	25			25			25			25		
Lane Util. Factor	1.00	1.00	1.00	1.00	1.00	1.00	0.91	0.91	0.95	1.00	1.00	0.88
Ped Bike Factor	0.77				0.91		0.60	0.93		0.59		0.43
Frt					0.961			0.990				0.850
Flt Protected	0.950						0.950	0.998		0.950		
Satd. Flow (prot)	1488	1620	0	0	1403	0	1259	2484	0	1439	0	2345
Flt Permitted	0.492						0.950	0.998		0.950		
Satd. Flow (perm)	595	1620	0	0	1403	0	757	2443	0	843	0	1014
Right Turn on Red			No			No			No			No
Satd. Flow (RTOR)												
Link Speed (mph)		25			25			25				25
Link Distance (ft)		273			989			826				981
Travel Time (s)		10.7			57.6			22.5				26.8
Confl. Peds. (#/hr)	207		358	358		207	244		349	349		244
Peak Hour Factor	0.93	0.93	0.93	0.84	0.84	0.84	0.86	0.86	0.86	0.86	0.86	0.86
Heavy Vehicles (%)	5%	5%	5%	7%	7%	7%	9%	9%	9%	8%	8%	8%
Adj. Flow (vph)	18	54	0	0	105	43	193	405	30	49	0	435
Shared Lane Traffic (%)							10%					
Lane Group Flow (vph)	18	54	0	0	148	0	174	454	0	49	0	435
Turn Type	Perm	NA			NA		Split	NA		Prot		Prot
Protected Phases		4			8		2	2		1		1
Permitted Phases	4									1		1
Detector Phase	4	4			8		2	2		1		1
Switch Phase												
Minimum Initial (s)	10.0	10.0			10.0		7.0	7.0		7.0		7.0
Minimum Split (s)	24.0	24.0			31.0		18.0	18.0		26.0		26.0
Total Split (s)	31.0	31.0			31.0		41.0	41.0		30.0		30.0
Total Split (%)	23.8%	23.8%			23.8%		31.5%	31.5%		23.1%		23.1%
Maximum Green (s)	24.8	24.8			24.8		35.1	35.1		24.4		24.4
Yellow Time (s)	3.2	3.2			3.2		3.1	3.1		3.0		3.0
All-Red Time (s)	3.0	3.0			3.0		2.8	2.8		2.6		2.6
Lost Time Adjust (s)	-1.2	-1.2			-1.2		-0.9	-0.9		-0.6		-0.6
Total Lost Time (s)	5.0	5.0			5.0		5.0	5.0		5.0		5.0
Lead/Lag							Lag	Lag		Lead		Lead
Lead-Lag Optimize?							Yes	Yes		Yes		Yes
Vehicle Extension (s)	2.0	2.0			2.0		4.0	4.0		4.0		4.0
Recall Mode	None	None			None		C-Max	C-Max		None		None
Walk Time (s)	7.0	7.0			7.0		7.0	7.0		7.0		7.0
Flash Dont Walk (s)	10.0	10.0			17.0		5.0	5.0		13.0		13.0
Pedestrian Calls (#/hr)	0	0			0		0	0		0		0
Act Effect Green (s)	19.1	19.1			19.1		62.8	62.8		33.2		33.2

Lane Group	Ø9
Lane Configurations	
Traffic Volume (vph)	
Future Volume (vph)	
Ideal Flow (vphpl)	
Lane Width (ft)	
Grade (%)	
Storage Length (ft)	
Storage Lanes	
Taper Length (ft)	
Lane Util. Factor	
Ped Bike Factor	
Frt	
Flt Protected	
Satd. Flow (prot)	
Flt Permitted	
Satd. Flow (perm)	
Right Turn on Red	
Satd. Flow (RTOR)	
Link Speed (mph)	
Link Distance (ft)	
Travel Time (s)	
Confl. Peds. (#/hr)	
Peak Hour Factor	
Heavy Vehicles (%)	
Adj. Flow (vph)	
Shared Lane Traffic (%)	
Lane Group Flow (vph)	
Turn Type	
Protected Phases	9
Permitted Phases	
Detector Phase	
Switch Phase	
Minimum Initial (s)	7.0
Minimum Split (s)	28.0
Total Split (s)	28.0
Total Split (%)	22%
Maximum Green (s)	24.0
Yellow Time (s)	3.0
All-Red Time (s)	1.0
Lost Time Adjust (s)	
Total Lost Time (s)	
Lead/Lag	
Lead-Lag Optimize?	
Vehicle Extension (s)	0.2
Recall Mode	None
Walk Time (s)	7.0
Flash Dont Walk (s)	17.0
Pedestrian Calls (#/hr)	0
Act Effect Green (s)	

Lanes, Volumes, Timings

2020 Existing Noon Peak

16: NC 86 (S. Columbia St) & W. Cameron Avenue/E. Cameron Avenue

Timing Plan: Noon Peak

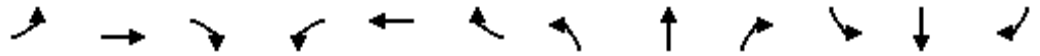

Lane Group	EBL	EBT	EBR	WBL	WBT	WBR	NBL	NBT	NBR	SBL	SBT	SBR
Actuated g/C Ratio	0.15	0.15			0.15		0.48	0.48		0.26		0.26
v/c Ratio	0.21	0.23			0.72		0.29	0.38		0.13		0.73
Control Delay	86.0	83.1			71.6		24.2	24.2		14.5		27.4
Queue Delay	0.0	0.0			0.0		0.0	0.0		0.0		0.0
Total Delay	86.0	83.1			71.6		24.2	24.2		14.5		27.4
LOS	F	F			E		C	C		B		C
Approach Delay		83.8			71.6			24.2				26.1
Approach LOS		F			E			C				C
Queue Length 50th (ft)	16	47			120		95	131		22		181
Queue Length 95th (ft)	m23	m69			171		172	196		m33		222
Internal Link Dist (ft)		193			909			746				901
Turn Bay Length (ft)	100									310		
Base Capacity (vph)	119	324			280		607	1199		367		598
Starvation Cap Reductn	0	0			0		0	0		0		0
Spillback Cap Reductn	0	0			0		0	0		0		0
Storage Cap Reductn	0	0			0		0	0		0		0
Reduced v/c Ratio	0.15	0.17			0.53		0.29	0.38		0.13		0.73

Intersection Summary

Area Type: CBD
 Cycle Length: 130
 Actuated Cycle Length: 130
 Offset: 0 (0%), Referenced to phase 2:NBTL, Start of Green
 Natural Cycle: 105
 Control Type: Actuated-Coordinated
 Maximum v/c Ratio: 0.73
 Intersection Signal Delay: 33.4
 Intersection LOS: C
 Intersection Capacity Utilization 67.0%
 ICU Level of Service C
 Analysis Period (min) 15
 m Volume for 95th percentile queue is metered by upstream signal.

Splits and Phases: 16: NC 86 (S. Columbia St) & W. Cameron Avenue/E. Cameron Avenue

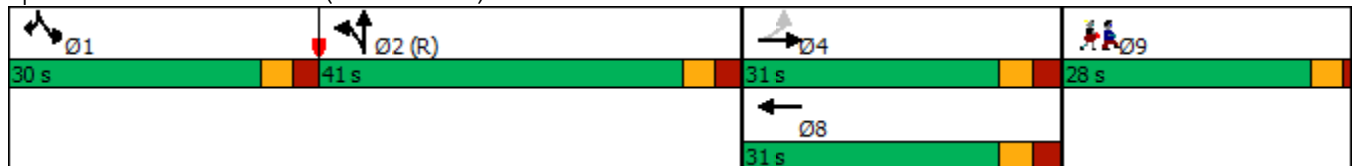

Lane Group	Ø9
Actuated g/C Ratio	
v/c Ratio	
Control Delay	
Queue Delay	
Total Delay	
LOS	
Approach Delay	
Approach LOS	
Queue Length 50th (ft)	
Queue Length 95th (ft)	
Internal Link Dist (ft)	
Turn Bay Length (ft)	
Base Capacity (vph)	
Starvation Cap Reductn	
Spillback Cap Reductn	
Storage Cap Reductn	
Reduced v/c Ratio	
Intersection Summary	

Lanes, Volumes, Timings

2020 Existing Noon Peak

17: Raleigh Street & E. Cameron Avenue/Country Club Road

Timing Plan: Noon Peak

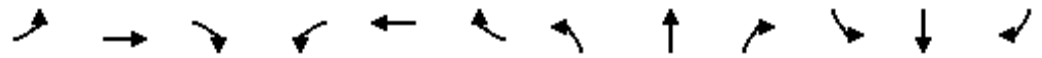

Lane Group	EBL	EBT	EBR	WBL	WBT	WBR	NBL	NBT	NBR	SBL	SBT	SBR
Lane Configurations		↕		↖	↗		↖	↗		↖	↗	
Traffic Volume (vph)	30	63	32	21	84	162	32	71	27	228	105	43
Future Volume (vph)	30	63	32	21	84	162	32	71	27	228	105	43
Ideal Flow (vphpl)	1900	1900	1900	1900	1900	1900	1900	1900	1900	1900	1900	1900
Grade (%)		-3%			3%			-2%			1%	
Storage Length (ft)	0		0	150		0	125		0	75		0
Storage Lanes	0		0	1		0	1		0	1		0
Taper Length (ft)	25			25			25			25		
Lane Util. Factor	1.00	1.00	1.00	1.00	1.00	1.00	1.00	1.00	1.00	1.00	1.00	1.00
Ped Bike Factor		0.91		0.89	0.87		0.66	0.95		0.87	0.84	
Frt		0.965			0.901			0.959			0.957	
Flt Protected		0.988		0.950			0.950			0.950		
Satd. Flow (prot)	0	1513	0	1569	1293	0	1505	1446	0	1554	1323	0
Flt Permitted		0.849		0.541			0.658			0.453		
Satd. Flow (perm)	0	1262	0	799	1293	0	688	1446	0	643	1323	0
Right Turn on Red			No			No			No			No
Satd. Flow (RTOR)												
Link Speed (mph)		25			25			25			25	
Link Distance (ft)		598			651			409			995	
Travel Time (s)		16.3			17.8			11.2			27.1	
Confl. Peds. (#/hr)	38		43	43		38	103		33	33		103
Peak Hour Factor	0.87	0.87	0.87	0.91	0.91	0.91	0.93	0.93	0.93	0.95	0.95	0.95
Heavy Vehicles (%)	2%	2%	2%	2%	2%	2%	9%	9%	9%	4%	4%	4%
Adj. Flow (vph)	34	72	37	23	92	178	34	76	29	240	111	45
Shared Lane Traffic (%)												
Lane Group Flow (vph)	0	143	0	23	270	0	34	105	0	240	156	0
Turn Type	Perm	NA		pm+pt	NA		pm+pt	NA		pm+pt	NA	
Protected Phases		2		1	6		3	8		7	4	
Permitted Phases	2			6			8			4		
Detector Phase	2	2		1	6		3	8		7	4	
Switch Phase												
Minimum Initial (s)	10.0	10.0		7.0	10.0		7.0	7.0		7.0	7.0	
Minimum Split (s)	18.0	18.0		13.0	19.0		13.0	19.0		12.0	16.0	
Total Split (s)	50.0	50.0		20.0	70.0		20.0	35.0		20.0	35.0	
Total Split (%)	40.0%	40.0%		16.0%	56.0%		16.0%	28.0%		16.0%	28.0%	
Maximum Green (s)	43.9	43.9		14.4	64.4		14.7	29.7		15.1	29.9	
Yellow Time (s)	3.3	3.3		3.0	3.1		3.0	3.1		3.0	3.1	
All-Red Time (s)	2.8	2.8		2.6	2.5		2.3	2.2		1.9	2.0	
Lost Time Adjust (s)		-1.1		-0.6	-0.6		-0.3	-0.3		0.1	-0.1	
Total Lost Time (s)		5.0		5.0	5.0		5.0	5.0		5.0	5.0	
Lead/Lag	Lag	Lag		Lead			Lead	Lag		Lead	Lag	
Lead-Lag Optimize?	Yes	Yes		Yes			Yes	Yes		Yes	Yes	
Vehicle Extension (s)	2.0	2.0		2.0	2.0		2.0	2.0		2.0	2.0	
Recall Mode	None	None		None	None		None	None		None	None	
Walk Time (s)	4.0	4.0			4.0			4.0			4.0	
Flash Dont Walk (s)	7.0	7.0			9.0			9.0			6.0	
Pedestrian Calls (#/hr)	0	0			0			0			0	
Act Effect Green (s)		15.7		19.4	19.4		15.7	10.2		24.3	20.5	
Actuated g/C Ratio		0.29		0.35	0.35		0.29	0.19		0.44	0.37	

Lanes, Volumes, Timings
 17: Raleigh Street & E. Cameron Avenue/Country Club Road

2020 Existing Noon Peak
 Timing Plan: Noon Peak



Lane Group	EBL	EBT	EBR	WBL	WBT	WBR	NBL	NBT	NBR	SBL	SBT	SBR
v/c Ratio		0.40		0.06	0.59		0.11	0.39		0.48	0.32	
Control Delay		25.1		13.5	22.1		12.3	29.4		14.5	18.8	
Queue Delay		0.0		0.0	0.0		0.0	0.0		0.0	0.0	
Total Delay		25.1		13.5	22.1		12.3	29.4		14.5	18.8	
LOS		C		B	C		B	C		B	B	
Approach Delay		25.1			21.4			25.2			16.2	
Approach LOS		C			C			C			B	
Queue Length 50th (ft)		37		5	78		5	32		40	25	
Queue Length 95th (ft)		106		19	160		24	89		122	112	
Internal Link Dist (ft)		518			571			329			915	
Turn Bay Length (ft)				150			125			75		
Base Capacity (vph)		1021		551	1242		556	876		596	801	
Starvation Cap Reductn		0		0	0		0	0		0	0	
Spillback Cap Reductn		0		0	0		0	0		0	0	
Storage Cap Reductn		0		0	0		0	0		0	0	
Reduced v/c Ratio		0.14		0.04	0.22		0.06	0.12		0.40	0.19	

Intersection Summary

Area Type: CBD
 Cycle Length: 125
 Actuated Cycle Length: 54.9
 Natural Cycle: 65
 Control Type: Actuated-Uncoordinated
 Maximum v/c Ratio: 0.59
 Intersection Signal Delay: 20.4
 Intersection LOS: C
 Intersection Capacity Utilization 67.3%
 ICU Level of Service C
 Analysis Period (min) 15

Splits and Phases: 17: Raleigh Street & E. Cameron Avenue/Country Club Road



Lanes, Volumes, Timings
1: Church Street & W. Rosemary Street

2020 Existing PM Peak
Timing Plan: PM Peak



Lane Group	EBL	EBT	EBR	WBL	WBT	WBR	NBL	NBT	NBR	SBL	SBT	SBR
Lane Configurations		↕			↕			↕			↕	
Traffic Volume (vph)	24	398	64	54	416	36	46	77	62	24	74	25
Future Volume (vph)	24	398	64	54	416	36	46	77	62	24	74	25
Ideal Flow (vphpl)	1900	1900	1900	1900	1900	1900	1900	1900	1900	1900	1900	1900
Lane Width (ft)	12	14	12	12	14	12	12	12	12	12	12	12
Grade (%)		1%			-1%			0%			0%	
Lane Util. Factor	1.00	1.00	1.00	1.00	1.00	1.00	1.00	1.00	1.00	1.00	1.00	1.00
Ped Bike Factor		0.98			0.98			0.93			0.95	
Frt		0.982			0.990			0.955			0.973	
Flt Protected		0.998			0.995			0.988			0.990	
Satd. Flow (prot)	0	1707	0	0	1751	0	0	1516	0	0	1559	0
Flt Permitted		0.967			0.912			0.904			0.924	
Satd. Flow (perm)	0	1650	0	0	1597	0	0	1346	0	0	1436	0
Right Turn on Red			No			No			No			No
Satd. Flow (RTOR)												
Link Speed (mph)		20			20			25			25	
Link Distance (ft)		964			757			379			430	
Travel Time (s)		32.9			25.8			10.3			11.7	
Confl. Peds. (#/hr)	40		37	37		40	62		43	43		62
Peak Hour Factor	0.95	0.95	0.95	0.97	0.97	0.97	0.91	0.91	0.91	0.93	0.93	0.93
Adj. Flow (vph)	25	419	67	56	429	37	51	85	68	26	80	27
Shared Lane Traffic (%)												
Lane Group Flow (vph)	0	511	0	0	522	0	0	204	0	0	133	0
Turn Type	Perm	NA		Perm	NA		Perm	NA		Perm	NA	
Protected Phases		2			6			8			4	
Permitted Phases	2			6			8			4		
Detector Phase	2	2		6	6		8	8		4	4	
Switch Phase												
Minimum Initial (s)	10.0	10.0		10.0	10.0		7.0	7.0		7.0	7.0	
Minimum Split (s)	19.0	19.0		20.0	20.0		19.0	19.0		19.0	19.0	
Total Split (s)	45.0	45.0		45.0	45.0		25.0	25.0		25.0	25.0	
Total Split (%)	64.3%	64.3%		64.3%	64.3%		35.7%	35.7%		35.7%	35.7%	
Maximum Green (s)	40.5	40.5		40.4	40.4		20.1	20.1		20.1	20.1	
Yellow Time (s)	3.1	3.1		3.1	3.1		3.2	3.2		3.2	3.2	
All-Red Time (s)	1.4	1.4		1.5	1.5		1.7	1.7		1.7	1.7	
Lost Time Adjust (s)		0.5			0.4			0.1			0.1	
Total Lost Time (s)		5.0			5.0			5.0			5.0	
Lead/Lag												
Lead-Lag Optimize?												
Vehicle Extension (s)	3.0	3.0		3.0	3.0		3.0	3.0		3.0	3.0	
Recall Mode	C-Max	C-Max		C-Max	C-Max		None	None		None	None	
Walk Time (s)	4.0	4.0		4.0	4.0		4.0	4.0		4.0	4.0	
Flash Dont Walk (s)	5.0	5.0		6.0	6.0		10.0	10.0		10.0	10.0	
Pedestrian Calls (#/hr)	0	0		0	0		0	0		0	0	
Act Effct Green (s)		44.7			44.7			15.3			15.3	
Actuated g/C Ratio		0.64			0.64			0.22			0.22	
v/c Ratio		0.48			0.51			0.70			0.42	
Control Delay		9.5			12.5			33.2			26.7	
Queue Delay		0.0			0.0			0.0			0.0	

Lanes, Volumes, Timings
 1: Church Street & W. Rosemary Street

2020 Existing PM Peak
 Timing Plan: PM Peak



Lane Group	EBL	EBT	EBR	WBL	WBT	WBR	NBL	NBT	NBR	SBL	SBT	SBR
Total Delay		9.5			12.5			33.2			26.7	
LOS		A			B			C			C	
Approach Delay		9.5			12.5			33.2			26.7	
Approach LOS		A			B			C			C	
Queue Length 50th (ft)		102			192			86			49	
Queue Length 95th (ft)		203			m244			132			89	
Internal Link Dist (ft)		884			677			299			350	
Turn Bay Length (ft)												
Base Capacity (vph)		1054			1020			384			410	
Starvation Cap Reductn		0			0			0			0	
Spillback Cap Reductn		0			0			0			0	
Storage Cap Reductn		0			0			0			0	
Reduced v/c Ratio		0.48			0.51			0.53			0.32	

Intersection Summary

Area Type:	CBD
Cycle Length:	70
Actuated Cycle Length:	70
Offset:	66 (94%), Referenced to phase 2:EBTL and 6:WBTL, Start of Green
Natural Cycle:	45
Control Type:	Actuated-Coordinated
Maximum v/c Ratio:	0.70
Intersection Signal Delay:	15.8
Intersection LOS:	B
Intersection Capacity Utilization:	75.2%
ICU Level of Service:	D
Analysis Period (min):	15
m Volume for 95th percentile queue is metered by upstream signal.	

Splits and Phases: 1: Church Street & W. Rosemary Street



Lanes, Volumes, Timings
 2: NC 86 (N. Columbia St) & W. Rosemary Street/E. Rosemary Street

2020 Existing PM Peak
 Timing Plan: PM Peak



Lane Group	EBL	EBT	EBR	WBL	WBT	WBR	NBL	NBT	NBR	SBL	SBT	SBR
Lane Configurations												
Traffic Volume (vph)	217	257	48	51	209	43	50	565	74	71	492	264
Future Volume (vph)	217	257	48	51	209	43	50	565	74	71	492	264
Ideal Flow (vphpl)	1900	1900	1900	1900	1900	1900	1900	1900	1900	1900	1900	1900
Lane Width (ft)	9	12	13	12	12	12	9	10	12	12	9	11
Grade (%)		1%			1%			-2%			8%	
Storage Length (ft)	100		0	150		0	75		0	150		400
Storage Lanes	1		0	1		0	1		0	1		1
Taper Length (ft)	25			25			25			25		
Lane Util. Factor	1.00	1.00	1.00	1.00	1.00	1.00	1.00	0.95	0.95	1.00	0.95	1.00
Ped Bike Factor	0.97	0.99		0.96	0.98		0.93	0.96				0.73
Frt		0.976			0.974			0.983				0.850
Flt Protected	0.950			0.950			0.950			0.950		
Satd. Flow (prot)	1426	1610	0	1585	1600	0	1420	2776	0	1514	2725	1310
Flt Permitted	0.201			0.553			0.370			0.268		
Satd. Flow (perm)	292	1610	0	888	1600	0	515	2776	0	427	2725	952
Right Turn on Red			No			No			No			No
Satd. Flow (RTOR)												
Link Speed (mph)		20			20			25			25	
Link Distance (ft)		757			339			353			476	
Travel Time (s)		25.8			11.6			9.6			13.0	
Confl. Peds. (#/hr)	49		36	36		49	59		83	83		59
Peak Hour Factor	0.88	0.88	0.88	0.94	0.94	0.94	0.83	0.83	0.83	0.82	0.82	0.82
Heavy Vehicles (%)	2%	2%	2%	2%	2%	2%	4%	4%	4%	3%	3%	3%
Adj. Flow (vph)	247	292	55	54	222	46	60	681	89	87	600	322
Shared Lane Traffic (%)												
Lane Group Flow (vph)	247	347	0	54	268	0	60	770	0	87	600	322
Turn Type	pm+pt	NA		Perm	NA		pm+pt	NA		pm+pt	NA	pm+ov
Protected Phases	7	4			8		5	2		1	6	7
Permitted Phases	4			8			2			6		6
Detector Phase	7	4		8	8		5	2		1	6	7
Switch Phase												
Minimum Initial (s)	7.0	7.0		7.0	7.0		7.0	10.0		7.0	10.0	7.0
Minimum Split (s)	13.0	31.0		32.0	32.0		13.0	23.0		13.0	22.0	13.0
Total Split (s)	24.0	56.0		32.0	32.0		20.0	64.0		20.0	64.0	24.0
Total Split (%)	17.1%	40.0%		22.9%	22.9%		14.3%	45.7%		14.3%	45.7%	17.1%
Maximum Green (s)	18.2	50.0		26.0	26.0		14.2	58.2		14.9	58.2	18.2
Yellow Time (s)	3.0	3.2		3.2	3.2		3.0	3.3		3.0	3.3	3.0
All-Red Time (s)	2.8	2.8		2.8	2.8		2.8	2.5		2.1	2.5	2.8
Lost Time Adjust (s)	-0.8	-1.0		-1.0	-1.0		-1.0	-0.8		-0.1	-0.8	-0.8
Total Lost Time (s)	5.0	5.0		5.0	5.0		4.8	5.0		5.0	5.0	5.0
Lead/Lag	Lead			Lag	Lag		Lead	Lag		Lead	Lag	Lead
Lead-Lag Optimize?												
Vehicle Extension (s)	1.0	1.0		1.0	1.0		1.0	3.0		1.0	3.0	1.0
Recall Mode	None	None		None	None		None	C-Max		None	C-Max	None
Walk Time (s)		7.0		7.0	7.0			7.0			7.0	
Flash Dont Walk (s)		18.0		19.0	19.0			10.0			9.0	
Pedestrian Calls (#/hr)		0		0	0			0			0	
Act Effect Green (s)	49.5	49.5		25.5	25.5		76.0	67.4		76.5	69.9	88.9

Lanes, Volumes, Timings
 2: NC 86 (N. Columbia St) & W. Rosemary Street/E. Rosemary Street

2020 Existing PM Peak
 Timing Plan: PM Peak



Lane Group	EBL	EBT	EBR	WBL	WBT	WBR	NBL	NBT	NBR	SBL	SBT	SBR
Actuated g/C Ratio	0.35	0.35		0.18	0.18		0.54	0.48		0.55	0.50	0.64
v/c Ratio	0.96	0.61		0.33	0.92		0.18	0.58		0.29	0.44	0.49
Control Delay	86.0	37.7		60.3	95.2		9.0	11.6		16.7	24.9	16.1
Queue Delay	0.0	0.0		0.0	0.0		0.0	1.4		0.0	0.0	0.0
Total Delay	86.0	37.7		60.3	95.2		9.0	13.0		16.7	24.9	16.1
LOS	F	D		E	F		A	B		B	C	B
Approach Delay		57.8			89.4			12.7			21.4	
Approach LOS		E			F			B			C	
Queue Length 50th (ft)	179	233		44	252		11	76		35	190	130
Queue Length 95th (ft)	#323	299		94	#406		m15	95		57	220	173
Internal Link Dist (ft)		677			259			273			396	
Turn Bay Length (ft)	100			150			75			150		400
Base Capacity (vph)	257	586		171	308		394	1337		361	1360	652
Starvation Cap Reductn	0	0		0	0		0	353		0	0	0
Spillback Cap Reductn	0	0		0	0		0	0		0	3	0
Storage Cap Reductn	0	0		0	0		0	0		0	0	0
Reduced v/c Ratio	0.96	0.59		0.32	0.87		0.15	0.78		0.24	0.44	0.49

Intersection Summary

Area Type: CBD
 Cycle Length: 140
 Actuated Cycle Length: 140
 Offset: 70 (50%), Referenced to phase 2:NBTL and 6:SBTL, Start of Green
 Natural Cycle: 85
 Control Type: Actuated-Coordinated
 Maximum v/c Ratio: 0.96
 Intersection Signal Delay: 34.6 Intersection LOS: C
 Intersection Capacity Utilization 77.0% ICU Level of Service D
 Analysis Period (min) 15
 # 95th percentile volume exceeds capacity, queue may be longer.
 Queue shown is maximum after two cycles.
 m Volume for 95th percentile queue is metered by upstream signal.

Splits and Phases: 2: NC 86 (N. Columbia St) & W. Rosemary Street/E. Rosemary Street

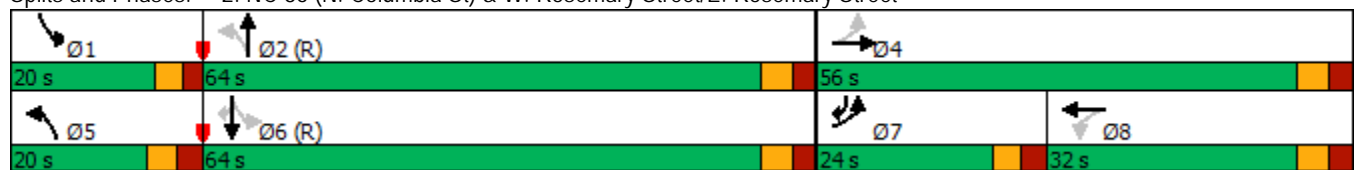

Lanes, Volumes, Timings
6: Henderson Street & E. Rosemary Street

2020 Existing PM Peak
Timing Plan: PM Peak



Lane Group	EBL	EBT	EBR	WBL	WBT	WBR	NBL	NBT	NBR	SBL	SBT	SBR
Lane Configurations												
Traffic Volume (vph)	42	282	169	12	191	56	60	24	5	23	40	10
Future Volume (vph)	42	282	169	12	191	56	60	24	5	23	40	10
Ideal Flow (vphpl)	1900	1900	1900	1900	1900	1900	1900	1900	1900	1900	1900	1900
Grade (%)		0%			0%			0%			3%	
Storage Length (ft)	85		0	0		0	0		0	0		0
Storage Lanes	1		0	0		0	0		0	0		0
Taper Length (ft)	25			25			25			25		
Lane Util. Factor	1.00	1.00	1.00	1.00	1.00	1.00	1.00	1.00	1.00	1.00	1.00	1.00
Ped Bike Factor	0.98	0.95			0.98			0.88			0.94	
Frt		0.944			0.971			0.993			0.981	
Flt Protected	0.950				0.998			0.967			0.985	
Satd. Flow (prot)	1593	1508	0	0	1602	0	0	1597	0	0	1548	0
Flt Permitted	0.627				0.977			0.794			0.893	
Satd. Flow (perm)	1026	1508	0	0	1566	0	0	1158	0	0	1355	0
Right Turn on Red			No			No			No			No
Satd. Flow (RTOR)												
Link Speed (mph)		20			20			20			20	
Link Distance (ft)		156			1195			366			450	
Travel Time (s)		5.3			40.7			12.5			15.3	
Confl. Peds. (#/hr)	14		34	34		14	73		51	51		73
Peak Hour Factor	0.90	0.90	0.90	0.93	0.93	0.93	0.67	0.67	0.67	0.79	0.79	0.79
Adj. Flow (vph)	47	313	188	13	205	60	90	36	7	29	51	13
Shared Lane Traffic (%)												
Lane Group Flow (vph)	47	501	0	0	278	0	0	133	0	0	93	0
Turn Type	Perm	NA		Perm	NA		Perm	NA		Perm	NA	
Protected Phases		2			2			4			4	
Permitted Phases	2			2			4			4		
Detector Phase	2	2		2	2		4	4		4	4	
Switch Phase												
Minimum Initial (s)	11.0	11.0		11.0	11.0		8.0	8.0		8.0	8.0	
Minimum Split (s)	15.9	15.9		15.9	15.9		17.8	17.8		17.8	17.8	
Total Split (s)	35.0	35.0		35.0	35.0		35.0	35.0		35.0	35.0	
Total Split (%)	50.0%	50.0%		50.0%	50.0%		50.0%	50.0%		50.0%	50.0%	
Maximum Green (s)	30.1	30.1		30.1	30.1		30.2	30.2		30.2	30.2	
Yellow Time (s)	3.3	3.3		3.3	3.3		3.3	3.3		3.3	3.3	
All-Red Time (s)	1.6	1.6		1.6	1.6		1.5	1.5		1.5	1.5	
Lost Time Adjust (s)	0.0	0.0			0.0			0.0			0.0	
Total Lost Time (s)	4.9	4.9			4.9			4.8			4.8	
Lead/Lag												
Lead-Lag Optimize?												
Vehicle Extension (s)	2.0	2.0		2.0	2.0		2.0	2.0		2.0	2.0	
Recall Mode	C-Max	C-Max		C-Max	C-Max		None	None		None	None	
Walk Time (s)	4.0	4.0		4.0	4.0		4.0	4.0		4.0	4.0	
Flash Dont Walk (s)	7.0	7.0		7.0	7.0		9.0	9.0		9.0	9.0	
Pedestrian Calls (#/hr)	0	0		0	0		0	0		0	0	
Act Effct Green (s)	50.6	50.6			50.6			13.2			13.2	
Actuated g/C Ratio	0.72	0.72			0.72			0.19			0.19	
v/c Ratio	0.06	0.46			0.25			0.61			0.36	

Lanes, Volumes, Timings
 6: Henderson Street & E. Rosemary Street

2020 Existing PM Peak
 Timing Plan: PM Peak



Lane Group	EBL	EBT	EBR	WBL	WBT	WBR	NBL	NBT	NBR	SBL	SBT	SBR
Control Delay	4.3	7.5			7.7			40.7			27.2	
Queue Delay	0.0	0.0			0.0			0.0			0.0	
Total Delay	4.3	7.5			7.7			40.7			27.2	
LOS	A	A			A			D			C	
Approach Delay		7.2			7.7			40.7			27.2	
Approach LOS		A			A			D			C	
Queue Length 50th (ft)	5	107			85			79			36	
Queue Length 95th (ft)	m13	285			142			100			58	
Internal Link Dist (ft)		76			1115			286			370	
Turn Bay Length (ft)	85											
Base Capacity (vph)	742	1090			1132			499			584	
Starvation Cap Reductn	0	0			0			0			0	
Spillback Cap Reductn	0	0			0			0			0	
Storage Cap Reductn	0	0			0			0			0	
Reduced v/c Ratio	0.06	0.46			0.25			0.27			0.16	

Intersection Summary

Area Type: CBD
 Cycle Length: 70
 Actuated Cycle Length: 70
 Offset: 49 (70%), Referenced to phase 2:EBWB, Start of Green
 Natural Cycle: 50
 Control Type: Actuated-Coordinated
 Maximum v/c Ratio: 0.61
 Intersection Signal Delay: 13.4
 Intersection LOS: B
 Intersection Capacity Utilization 48.1%
 ICU Level of Service A
 Analysis Period (min) 15
 m Volume for 95th percentile queue is metered by upstream signal.

Splits and Phases: 6: Henderson Street & E. Rosemary Street

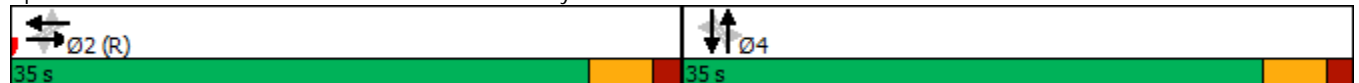

Lanes, Volumes, Timings
7: Hillsborough Street & E. Rosemary Street

2020 Existing PM Peak
Timing Plan: PM Peak



Lane Group	EBL	EBT	EBR	WBL	WBT	WBR	NBL	NBT	NBR	SBL	SBT	SBR
Lane Configurations		↕			↕		↕	↕		↕	↕	
Traffic Volume (vph)	33	132	83	10	97	55	163	251	23	36	178	24
Future Volume (vph)	33	132	83	10	97	55	163	251	23	36	178	24
Ideal Flow (vphpl)	1900	1900	1900	1900	1900	1900	1900	1900	1900	1900	1900	1900
Storage Length (ft)	0		0	0		0	100		0	100		0
Storage Lanes	0		0	0		0	1		0	1		0
Taper Length (ft)	25			25			25			25		
Lane Util. Factor	1.00	1.00	1.00	1.00	1.00	1.00	1.00	1.00	1.00	1.00	1.00	1.00
Ped Bike Factor		0.98			0.97		0.91	1.00		0.98	0.98	
Frt		0.955			0.954			0.987			0.982	
Flt Protected		0.993			0.997		0.950			0.950		
Satd. Flow (prot)	0	1736	0	0	1713	0	1770	1831	0	1770	1786	0
Flt Permitted		0.941			0.975		0.532			0.578		
Satd. Flow (perm)	0	1633	0	0	1674	0	905	1831	0	1054	1786	0
Right Turn on Red			No			No			No			No
Satd. Flow (RTOR)												
Link Speed (mph)		20			20			25			25	
Link Distance (ft)		1195			527			363			726	
Travel Time (s)		40.7			18.0			9.9			19.8	
Confl. Peds. (#/hr)	27		14	14		27	52		9	9		52
Peak Hour Factor	0.86	0.86	0.86	0.79	0.79	0.79	0.92	0.92	0.92	0.96	0.96	0.96
Adj. Flow (vph)	38	153	97	13	123	70	177	273	25	38	185	25
Shared Lane Traffic (%)												
Lane Group Flow (vph)	0	288	0	0	206	0	177	298	0	38	210	0
Turn Type	Perm	NA		Perm	NA		pm+pt	NA		Perm	NA	
Protected Phases		4			8		5	2			6	
Permitted Phases	4			8			2			6		
Detector Phase	4	4		8	8		5	2		6	6	
Switch Phase												
Minimum Initial (s)	7.0	7.0		7.0	7.0		7.0	10.0		10.0	10.0	
Minimum Split (s)	19.9	19.9		17.0	17.0		11.8	14.8		14.8	14.8	
Total Split (s)	35.0	35.0		35.0	35.0		15.0	35.0		20.0	20.0	
Total Split (%)	50.0%	50.0%		50.0%	50.0%		21.4%	50.0%		28.6%	28.6%	
Maximum Green (s)	30.1	30.1		30.0	30.0		10.2	30.2		15.2	15.2	
Yellow Time (s)	3.0	3.0		3.3	3.3		3.0	3.3		3.1	3.1	
All-Red Time (s)	1.9	1.9		1.7	1.7		1.8	1.5		1.7	1.7	
Lost Time Adjust (s)		0.0			0.0		0.0	0.0		0.0	0.0	
Total Lost Time (s)		4.9			5.0		4.8	4.8		4.8	4.8	
Lead/Lag							Lead			Lag	Lag	
Lead-Lag Optimize?							Yes			Yes	Yes	
Vehicle Extension (s)	2.0	2.0		2.0	2.0		2.0	2.0		2.0	2.0	
Recall Mode	None	None		None	None		None	C-Max		C-Max	C-Max	
Walk Time (s)	4.0	4.0		4.0	4.0			4.0		4.0	4.0	
Flash Dont Walk (s)	11.0	11.0		8.0	8.0			6.0		6.0	6.0	
Pedestrian Calls (#/hr)	0	0		0	0			0		0	0	
Act Effct Green (s)		17.0			16.9		43.3	43.3		30.2	30.2	
Actuated g/C Ratio		0.24			0.24		0.62	0.62		0.43	0.43	
v/c Ratio		0.73			0.51		0.27	0.26		0.08	0.27	
Control Delay		27.0			26.3		8.3	8.7		16.0	16.4	

Lanes, Volumes, Timings
7: Hillsborough Street & E. Rosemary Street

2020 Existing PM Peak
Timing Plan: PM Peak



Lane Group	EBL	EBT	EBR	WBL	WBT	WBR	NBL	NBT	NBR	SBL	SBT	SBR
Queue Delay		0.0			0.0		0.0	0.0		0.0	0.0	
Total Delay		27.0			26.3		8.3	8.7		16.0	16.4	
LOS		C			C		A	A		B	B	
Approach Delay		27.0			26.3			8.5			16.4	
Approach LOS		C			C			A			B	
Queue Length 50th (ft)		142			77		44	92		9	54	
Queue Length 95th (ft)		125			100		74	124		34	129	
Internal Link Dist (ft)		1115			447			283			646	
Turn Bay Length (ft)							100			100		
Base Capacity (vph)		702			717		688	1132		454	769	
Starvation Cap Reductn		0			0		0	0		0	0	
Spillback Cap Reductn		0			0		0	0		0	15	
Storage Cap Reductn		0			0		0	0		0	0	
Reduced v/c Ratio		0.41			0.29		0.26	0.26		0.08	0.28	

Intersection Summary

Area Type:	Other
Cycle Length:	70
Actuated Cycle Length:	70
Offset:	66 (94%), Referenced to phase 2:NBTL and 6:SBTL, Start of Green
Natural Cycle:	50
Control Type:	Actuated-Coordinated
Maximum v/c Ratio:	0.73
Intersection Signal Delay:	17.5
Intersection LOS:	B
Intersection Capacity Utilization	58.7%
ICU Level of Service	B
Analysis Period (min)	15

Splits and Phases: 7: Hillsborough Street & E. Rosemary Street

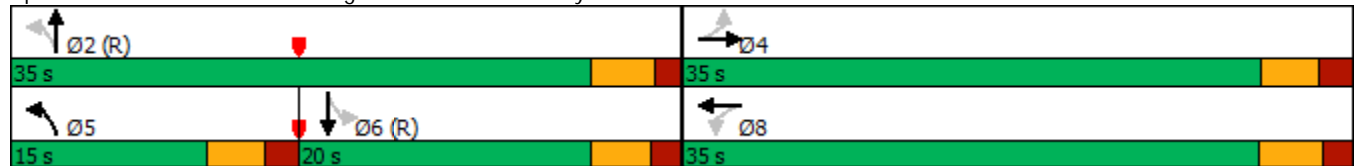

Lanes, Volumes, Timings
 8: Carolina Square Driveway/Church Street & W. Franklin Street

2020 Existing PM Peak
 Timing Plan: PM Peak



Lane Group	EBL	EBT	EBR	WBL	WBT	WBR	NBL	NBT	NBR	SBL	SBT	SBR
Lane Configurations												
Traffic Volume (vph)	64	447	18	40	549	71	24	47	39	72	58	70
Future Volume (vph)	64	447	18	40	549	71	24	47	39	72	58	70
Ideal Flow (vphpl)	1900	1900	1900	1900	1900	1900	1900	1900	1900	1900	1900	1900
Lane Width (ft)	10	10	16	10	10	10	12	12	12	12	12	12
Grade (%)		2%			-2%			-4%			-3%	
Storage Length (ft)	150		0	200		0	0		100	0		0
Storage Lanes	1		0	1		0	0		1	0		0
Taper Length (ft)	25			25			25			25		
Lane Util. Factor	1.00	0.95	0.95	1.00	0.95	0.95	1.00	1.00	1.00	1.00	1.00	1.00
Ped Bike Factor	0.88	0.99		0.83	0.96			0.96	0.93		0.92	
Frt		0.994			0.983				0.850		0.953	
Flt Protected	0.950			0.950				0.983			0.982	
Satd. Flow (prot)	1457	2855	0	1501	2835	0	0	1681	1454	0	1490	0
Flt Permitted	0.384			0.464				0.862			0.847	
Satd. Flow (perm)	521	2855	0	608	2835	0	0	1416	1350	0	1261	0
Right Turn on Red			No			No			No			No
Satd. Flow (RTOR)												
Link Speed (mph)		20			20			20			25	
Link Distance (ft)		993			755			285			379	
Travel Time (s)		33.9			25.7			9.7			10.3	
Confl. Peds. (#/hr)	124		164	164		124	175		63	63		175
Peak Hour Factor	0.91	0.91	0.91	0.93	0.93	0.93	0.81	0.81	0.81	0.91	0.91	0.91
Heavy Vehicles (%)	3%	3%	3%	2%	2%	2%	2%	2%	2%	2%	2%	2%
Adj. Flow (vph)	70	491	20	43	590	76	30	58	48	79	64	77
Shared Lane Traffic (%)												
Lane Group Flow (vph)	70	511	0	43	666	0	0	88	48	0	220	0
Turn Type	Perm	NA		Perm	NA		Perm	NA	Perm	Perm	NA	
Protected Phases		2			6			8			4	
Permitted Phases	2			6			8		8	4		
Detector Phase	2	2		6	6		8	8	8	4	4	
Switch Phase												
Minimum Initial (s)	10.0	10.0		10.0	10.0		7.0	7.0	7.0	7.0	7.0	
Minimum Split (s)	22.0	22.0		19.0	19.0		29.0	29.0	29.0	27.0	27.0	
Total Split (s)	41.0	41.0		41.0	41.0		29.0	29.0	29.0	29.0	29.0	
Total Split (%)	58.6%	58.6%		58.6%	58.6%		41.4%	41.4%	41.4%	41.4%	41.4%	
Maximum Green (s)	35.4	35.4		35.4	35.4		22.7	22.7	22.7	23.0	23.0	
Yellow Time (s)	3.3	3.3		3.3	3.3		3.1	3.1	3.1	3.4	3.4	
All-Red Time (s)	2.3	2.3		2.3	2.3		3.2	3.2	3.2	2.6	2.6	
Lost Time Adjust (s)	-0.6	-0.6		-0.6	-0.6		-1.3	-1.3	-1.3	-1.0	-1.0	
Total Lost Time (s)	5.0	5.0		5.0	5.0		5.0	5.0	5.0	5.0	5.0	
Lead/Lag												
Lead-Lag Optimize?												
Vehicle Extension (s)	3.0	3.0		3.0	3.0		2.0	2.0	2.0	2.0	2.0	
Recall Mode	C-Max	C-Max		C-Max	C-Max		None	None	None	None	None	
Walk Time (s)	7.0	7.0		7.0	7.0		7.0	7.0	7.0	7.0	7.0	
Flash Dont Walk (s)	9.0	9.0		6.0	6.0		15.0	15.0	15.0	14.0	14.0	
Pedestrian Calls (#/hr)	0	0		0	0		0	0	0	0	0	
Act Effect Green (s)	42.8	42.8		42.8	42.8		17.2	17.2	17.2	17.2	17.2	

Lanes, Volumes, Timings
 8: Carolina Square Driveway/Church Street & W. Franklin Street

2020 Existing PM Peak
 Timing Plan: PM Peak



Lane Group	EBL	EBT	EBR	WBL	WBT	WBR	NBL	NBT	NBR	SBL	SBT	SBR
Actuated g/C Ratio	0.61	0.61		0.61	0.61			0.25	0.25		0.25	
v/c Ratio	0.22	0.29		0.12	0.38			0.25	0.14		0.71	
Control Delay	10.4	8.0		13.5	13.9			21.0	19.3		33.0	
Queue Delay	0.0	0.0		0.0	0.0			0.0	0.0		0.0	
Total Delay	10.4	8.0		13.5	13.9			21.0	19.3		33.0	
LOS	B	A		B	B			C	B		C	
Approach Delay		8.3			13.9			20.4			33.0	
Approach LOS		A			B			C			C	
Queue Length 50th (ft)	12	48		20	184			30	16		74	
Queue Length 95th (ft)	42	95		m34	263			51	32		102	
Internal Link Dist (ft)		913			675			205			299	
Turn Bay Length (ft)	150			200					100			
Base Capacity (vph)	318	1744		371	1731			485	462		432	
Starvation Cap Reductn	0	0		0	0			0	0		0	
Spillback Cap Reductn	0	0		0	0			0	0		0	
Storage Cap Reductn	0	0		0	0			0	0		0	
Reduced v/c Ratio	0.22	0.29		0.12	0.38			0.18	0.10		0.51	

Intersection Summary

Area Type: CBD
 Cycle Length: 70
 Actuated Cycle Length: 70
 Offset: 0 (0%), Referenced to phase 2:EBTL and 6:WBTL, Start of Green
 Natural Cycle: 55
 Control Type: Actuated-Coordinated
 Maximum v/c Ratio: 0.71
 Intersection Signal Delay: 15.0 Intersection LOS: B
 Intersection Capacity Utilization 62.8% ICU Level of Service B
 Analysis Period (min) 15
 m Volume for 95th percentile queue is metered by upstream signal.



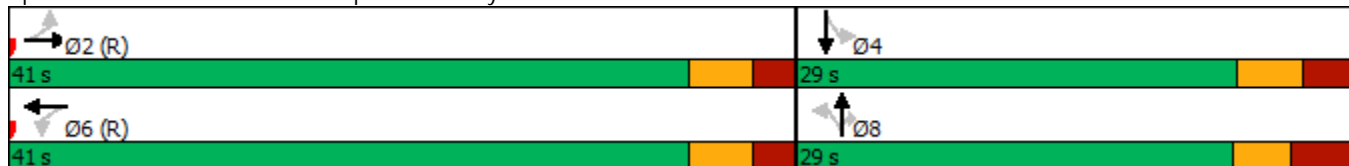

















Splits and Phases: 8: Carolina Square Driveway/Church Street & W. Franklin Street



Lanes, Volumes, Timings

2020 Existing PM Peak

9: NC 86 (S. Columbia St)/NC 86 (N. Columbia St) & W. Franklin Street/E. Franklin Street

												
Lane Group	EBL	EBT	EBR	WBL	WBT	WBR	NBL	NBT	NBR	SBL	SBT	SBR
Lane Configurations												
Traffic Volume (vph)	168	422	74	99	504	65	63	528	110	72	370	112
Future Volume (vph)	168	422	74	99	504	65	63	528	110	72	370	112
Ideal Flow (vphpl)	1900	1900	1900	1900	1900	1900	1900	1900	1900	1900	1900	1900
Lane Width (ft)	9	12	13	10	10	13	9	10	10	9	9	11
Grade (%)		3%			1%			-2%			3%	
Storage Length (ft)	250		0	125		0	475		0	125		0
Storage Lanes	1		0	1		0	1		0	1		0
Taper Length (ft)	25			25			25			25		
Lane Util. Factor	1.00	0.95	0.95	1.00	0.95	0.95	1.00	0.95	0.95	1.00	0.95	0.95
Ped Bike Factor	0.88	0.96		0.87	0.96		0.94	0.96		0.92	0.97	
Frt		0.978			0.983			0.974			0.965	
Flt Protected	0.950			0.950			0.950			0.950		
Satd. Flow (prot)	1412	2933	0	1479	2802	0	1380	2685	0	1385	2587	0
Flt Permitted	0.950			0.950			0.950			0.950		
Satd. Flow (perm)	1239	2933	0	1285	2802	0	1293	2685	0	1278	2587	0
Right Turn on Red			No			No			No			No
Satd. Flow (RTOR)												
Link Speed (mph)		20			20			25			25	
Link Distance (ft)		755			941			981			353	
Travel Time (s)		25.7			32.1			26.8			9.6	
Confl. Peds. (#/hr)	193		152	152		193	67		108	108		67
Peak Hour Factor	0.87	0.87	0.87	0.84	0.84	0.84	0.90	0.90	0.90	0.94	0.94	0.94
Heavy Vehicles (%)	2%	2%	2%	2%	2%	2%	7%	7%	7%	4%	4%	4%
Adj. Flow (vph)	193	485	85	118	600	77	70	587	122	77	394	119
Shared Lane Traffic (%)												
Lane Group Flow (vph)	193	570	0	118	677	0	70	709	0	77	513	0
Turn Type	Prot	NA		Prot	NA		Prot	NA		Prot	NA	
Protected Phases	5	2		1	6		3	8		7	4	
Permitted Phases												
Detector Phase	5	2		1	6		3	8		7	4	
Switch Phase												
Minimum Initial (s)	7.0	10.0		7.0	10.0		7.0	7.0		7.0	7.0	
Minimum Split (s)	15.0	28.2		15.0	28.2		15.0	28.0		15.0	28.1	
Total Split (s)	31.0	47.0		28.0	44.0		27.0	36.0		29.0	38.0	
Total Split (%)	22.1%	33.6%		20.0%	31.4%		19.3%	25.7%		20.7%	27.1%	
Maximum Green (s)	25.6	40.8		22.1	37.8		21.1	30.1		23.1	32.3	
Yellow Time (s)	3.0	3.0		3.0	3.0		3.0	3.3		3.0	3.1	
All-Red Time (s)	2.4	3.2		2.9	3.2		2.9	2.6		2.9	2.6	
Lost Time Adjust (s)	-0.4	-1.2		-0.9	-1.2		-0.9	-0.9		-0.9	-0.7	
Total Lost Time (s)	5.0	5.0		5.0	5.0		5.0	5.0		5.0	5.0	
Lead/Lag	Lead	Lag		Lead	Lag		Lead	Lag		Lead	Lag	
Lead-Lag Optimize?	Yes	Yes		Yes	Yes		Yes	Yes		Yes	Yes	
Vehicle Extension (s)	1.0	3.0		1.0	3.0		1.0	2.0		1.0	2.0	
Recall Mode	None	C-Max		None	C-Max		None	Ped		None	Ped	
Walk Time (s)		7.0			7.0			7.0			7.0	
Flash Dont Walk (s)		15.0			15.0			15.0			15.0	
Pedestrian Calls (#/hr)		0			0			0			0	
Act Effect Green (s)	22.0	49.5		15.5	43.0		11.8	42.6		12.4	45.8	

Lanes, Volumes, Timings

2020 Existing PM Peak

9: NC 86 (S. Columbia St)/NC 86 (N. Columbia St) & W. Franklin Street/E. Franklin Street



Lane Group	EBL	EBT	EBR	WBL	WBT	WBR	NBL	NBT	NBR	SBL	SBT	SBR
Actuated g/C Ratio	0.16	0.35		0.11	0.31		0.08	0.30		0.09	0.33	
v/c Ratio	0.87	0.55		0.72	0.79		0.60	0.87		0.63	0.61	
Control Delay	91.9	35.8		79.4	57.2		46.9	48.3		104.0	26.6	
Queue Delay	0.0	0.0		0.0	0.0		0.0	0.0		0.0	0.4	
Total Delay	91.9	35.8		79.4	57.2		46.9	48.3		104.0	27.0	
LOS	F	D		E	E		D	D		F	C	
Approach Delay		50.0			60.5			48.2			37.0	
Approach LOS		D			E			D			D	
Queue Length 50th (ft)	176	203		111	301		55	359		74	95	
Queue Length 95th (ft)	#267	252		166	381		m62	m#493		m130	117	
Internal Link Dist (ft)		675			861			901			273	
Turn Bay Length (ft)	250			125			475			125		
Base Capacity (vph)	262	1037		242	861		216	816		237	845	
Starvation Cap Reductn	0	0		0	0		0	0		0	72	
Spillback Cap Reductn	0	0		0	0		0	0		0	0	
Storage Cap Reductn	0	0		0	0		0	0		0	0	
Reduced v/c Ratio	0.74	0.55		0.49	0.79		0.32	0.87		0.32	0.66	

Intersection Summary

Area Type: CBD
 Cycle Length: 140
 Actuated Cycle Length: 140
 Offset: 0 (0%), Referenced to phase 2:EBT and 6:WBT, Start of Green
 Natural Cycle: 90
 Control Type: Actuated-Coordinated
 Maximum v/c Ratio: 0.87
 Intersection Signal Delay: 49.8 Intersection LOS: D
 Intersection Capacity Utilization 72.7% ICU Level of Service C
 Analysis Period (min) 15
 # 95th percentile volume exceeds capacity, queue may be longer.
 Queue shown is maximum after two cycles.
 m Volume for 95th percentile queue is metered by upstream signal.

Splits and Phases: 9: NC 86 (S. Columbia St)/NC 86 (N. Columbia St) & W. Franklin Street/E. Franklin Street

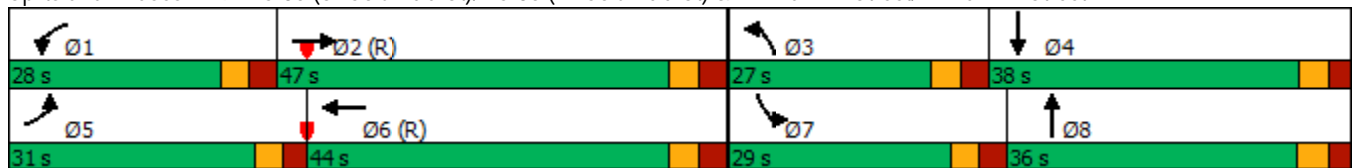

Lanes, Volumes, Timings
10: E. Franklin Street & Henderson Street

2020 Existing PM Peak
Timing Plan: PM Peak



Lane Group	EBL	EBT	WBT	WBR	SBL	SBR
Lane Configurations		↕↕	↕↔		↔↔	
Traffic Volume (vph)	33	589	635	64	166	56
Future Volume (vph)	33	589	635	64	166	56
Ideal Flow (vphpl)	1900	1900	1900	1900	1900	1900
Lane Width (ft)	10	13	10	10	11	11
Grade (%)		-2%	2%		3%	
Lane Util. Factor	0.95	0.95	0.95	0.95	1.00	1.00
Ped Bike Factor		1.00	0.97		0.87	
Frt			0.986		0.966	
Flt Protected		0.997			0.964	
Satd. Flow (prot)	0	3282	2827	0	1402	0
Flt Permitted		0.887			0.964	
Satd. Flow (perm)	0	2907	2827	0	1300	0
Right Turn on Red				No		No
Satd. Flow (RTOR)						
Link Speed (mph)		20	20		20	
Link Distance (ft)		941	1200		366	
Travel Time (s)		32.1	40.9		12.5	
Confl. Peds. (#/hr)	114			114	88	198
Peak Hour Factor	0.90	0.90	0.93	0.93	0.83	0.83
Heavy Vehicles (%)	3%	3%	2%	2%	2%	2%
Parking (#/hr)						0
Adj. Flow (vph)	37	654	683	69	200	67
Shared Lane Traffic (%)						
Lane Group Flow (vph)	0	691	752	0	267	0
Turn Type	Perm	NA	NA		Prot	
Protected Phases		2	6		4	
Permitted Phases	2					
Detector Phase	2	2	6		4	
Switch Phase						
Minimum Initial (s)	10.0	10.0	10.0		7.0	
Minimum Split (s)	16.2	16.2	21.1		24.1	
Total Split (s)	43.0	43.0	43.0		27.0	
Total Split (%)	61.4%	61.4%	61.4%		38.6%	
Maximum Green (s)	36.8	36.8	36.9		21.9	
Yellow Time (s)	3.0	3.0	3.0		3.0	
All-Red Time (s)	3.2	3.2	3.1		2.1	
Lost Time Adjust (s)		-1.2	-1.1		-0.1	
Total Lost Time (s)		5.0	5.0		5.0	
Lead/Lag						
Lead-Lag Optimize?						
Vehicle Extension (s)	2.0	2.0	2.0		1.0	
Recall Mode	C-Max	C-Max	C-Max		None	
Walk Time (s)			7.0		7.0	
Flash Dont Walk (s)			8.0		12.0	
Pedestrian Calls (#/hr)			0		0	
Act Effct Green (s)		43.5	43.5		16.5	
Actuated g/C Ratio		0.62	0.62		0.24	
v/c Ratio		0.38	0.43		0.81	

Lanes, Volumes, Timings
 10: E. Franklin Street & Henderson Street

2020 Existing PM Peak
 Timing Plan: PM Peak



Lane Group	EBL	EBT	WBT	WBR	SBL	SBR
Control Delay		6.7	13.3		46.6	
Queue Delay		0.0	0.0		0.0	
Total Delay		6.7	13.3		46.6	
LOS		A	B		D	
Approach Delay		6.7	13.3		46.6	
Approach LOS		A	B		D	
Queue Length 50th (ft)		162	155		148	
Queue Length 95th (ft)		m58	300		171	
Internal Link Dist (ft)		861	1120		286	
Turn Bay Length (ft)						
Base Capacity (vph)		1808	1758		440	
Starvation Cap Reductn		0	0		0	
Spillback Cap Reductn		0	0		0	
Storage Cap Reductn		0	0		0	
Reduced v/c Ratio		0.38	0.43		0.61	

Intersection Summary
 Area Type: CBD
 Cycle Length: 70
 Actuated Cycle Length: 70
 Offset: 35 (50%), Referenced to phase 2:EBTL and 6:WBT, Start of Green
 Natural Cycle: 50
 Control Type: Actuated-Coordinated
 Maximum v/c Ratio: 0.81
 Intersection Signal Delay: 15.8
 Intersection LOS: B
 Intersection Capacity Utilization 69.7%
 ICU Level of Service C
 Analysis Period (min) 15
 m Volume for 95th percentile queue is metered by upstream signal.

Splits and Phases: 10: E. Franklin Street & Henderson Street

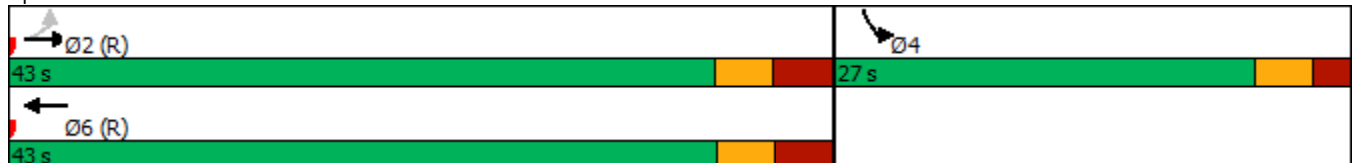

Lanes, Volumes, Timings

2020 Existing PM Peak

11: Raleigh Street/Hillsborough Street & E. Franklin Street

Timing Plan: PM Peak

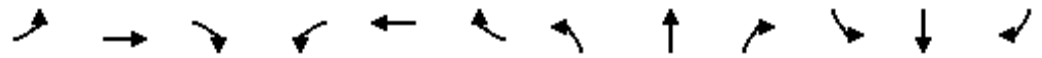

Lane Group	EBL	EBT	EBR	WBL	WBT	WBR	NBL	NBT	NBR	SBL	SBT	SBR
Lane Configurations												
Traffic Volume (vph)	50	541	234	61	645	214	51	180	23	56	196	13
Future Volume (vph)	50	541	234	61	645	214	51	180	23	56	196	13
Ideal Flow (vphpl)	1900	1900	1900	1900	1900	1900	1900	1900	1900	1900	1900	1900
Lane Width (ft)	9	9	10	9	10	11	12	12	12	10	10	10
Grade (%)		1%			-2%			1%			1%	
Storage Length (ft)	75		0	75		0	0		0	100		0
Storage Lanes	1		0	1		0	0		0	1		0
Taper Length (ft)	25			25			25			25		
Lane Util. Factor	1.00	0.95	0.95	1.00	0.95	0.95	1.00	1.00	1.00	1.00	1.00	1.00
Ped Bike Factor	1.00	0.99		1.00	0.99			0.99		0.99	0.99	
Frt		0.955			0.963			0.988			0.991	
Flt Protected	0.950			0.950				0.990		0.950		
Satd. Flow (prot)	1585	2990	0	1609	3181	0	0	1809	0	1643	1701	0
Flt Permitted	0.274			0.303				0.621		0.383		
Satd. Flow (perm)	455	2990	0	511	3181	0	0	1122	0	658	1701	0
Right Turn on Red			No			No			No			No
Satd. Flow (RTOR)												
Link Speed (mph)		20			30			25			25	
Link Distance (ft)		1200			1013			995			363	
Travel Time (s)		40.9			23.0			27.1			9.9	
Confl. Peds. (#/hr)	16		16	16		16	58		7	7		58
Peak Hour Factor	0.91	0.91	0.91	0.92	0.92	0.92	0.93	0.93	0.93	0.88	0.88	0.88
Adj. Flow (vph)	55	595	257	66	701	233	55	194	25	64	223	15
Shared Lane Traffic (%)												
Lane Group Flow (vph)	55	852	0	66	934	0	0	274	0	64	238	0
Turn Type	Perm	NA		Perm	NA		pm+pt	NA		D.Pm	NA	
Protected Phases		2			6		7	4			8	
Permitted Phases	2			6			4			4		
Detector Phase	2	2		6	6		7	4		4	8	
Switch Phase												
Minimum Initial (s)	10.0	10.0		10.0	10.0		7.0	7.0		7.0	7.0	
Minimum Split (s)	16.0	16.0		16.0	16.0		14.0	30.0		30.0	29.0	
Total Split (s)	60.0	60.0		60.0	60.0		20.0	80.0		80.0	60.0	
Total Split (%)	42.9%	42.9%		42.9%	42.9%		14.3%	57.1%		57.1%	42.9%	
Maximum Green (s)	54.7	54.7		54.7	54.7		13.8	73.6		73.6	53.6	
Yellow Time (s)	3.0	3.0		3.0	3.0		3.0	3.1		3.1	3.1	
All-Red Time (s)	2.3	2.3		2.3	2.3		3.2	3.3		3.3	3.3	
Lost Time Adjust (s)	-0.3	-0.3		-0.3	-0.3			-1.4		-1.4	-1.4	
Total Lost Time (s)	5.0	5.0		5.0	5.0			5.0		5.0	5.0	
Lead/Lag							Lead				Lag	
Lead-Lag Optimize?							Yes				Yes	
Vehicle Extension (s)	3.0	3.0		3.0	3.0		3.0	2.0		2.0	2.0	
Recall Mode	C-Max	C-Max		C-Max	C-Max		None	None		None	None	
Walk Time (s)								7.0		7.0	7.0	
Flash Dont Walk (s)								16.0		16.0	15.0	
Pedestrian Calls (#/hr)								0		0	0	
Act Effect Green (s)	98.9	98.9		98.9	98.9			31.1		31.1	31.1	
Actuated g/C Ratio	0.71	0.71		0.71	0.71			0.22		0.22	0.22	

Lanes, Volumes, Timings
 11: Raleigh Street/Hillsborough Street & E. Franklin Street

2020 Existing PM Peak
 Timing Plan: PM Peak



Lane Group	EBL	EBT	EBR	WBL	WBT	WBR	NBL	NBT	NBR	SBL	SBT	SBR
v/c Ratio	0.17	0.40		0.18	0.42			1.10		0.44	0.63	
Control Delay	14.6	16.0		10.2	10.1			136.6		55.5	57.6	
Queue Delay	0.0	0.0		0.0	0.0			0.0		0.0	0.2	
Total Delay	14.6	16.0		10.2	10.1			136.6		55.5	57.8	
LOS	B	B		B	B			F		E	E	
Approach Delay		15.9			10.1			136.6			57.3	
Approach LOS		B			B			F			E	
Queue Length 50th (ft)	28	251		18	169			~283		55	212	
Queue Length 95th (ft)	m61	345		50	268			#386		71	198	
Internal Link Dist (ft)		1120			933			915			283	
Turn Bay Length (ft)	75			75						100		
Base Capacity (vph)	321	2112		360	2247			601		352	668	
Starvation Cap Reductn	0	0		0	0			0		0	86	
Spillback Cap Reductn	0	0		0	0			0		0	0	
Storage Cap Reductn	0	0		0	0			0		0	0	
Reduced v/c Ratio	0.17	0.40		0.18	0.42			0.46		0.18	0.41	

Intersection Summary

Area Type: Other
 Cycle Length: 140
 Actuated Cycle Length: 140
 Offset: 0 (0%), Referenced to phase 2:EBTL and 6:WBTL, Start of Green
 Natural Cycle: 70
 Control Type: Actuated-Coordinated
 Maximum v/c Ratio: 1.10
 Intersection Signal Delay: 31.9
 Intersection LOS: C
 Intersection Capacity Utilization 82.3%
 ICU Level of Service E
 Analysis Period (min) 15
 ~ Volume exceeds capacity, queue is theoretically infinite.
 Queue shown is maximum after two cycles.
 # 95th percentile volume exceeds capacity, queue may be longer.
 Queue shown is maximum after two cycles.
 m Volume for 95th percentile queue is metered by upstream signal.

Splits and Phases: 11: Raleigh Street/Hillsborough Street & E. Franklin Street

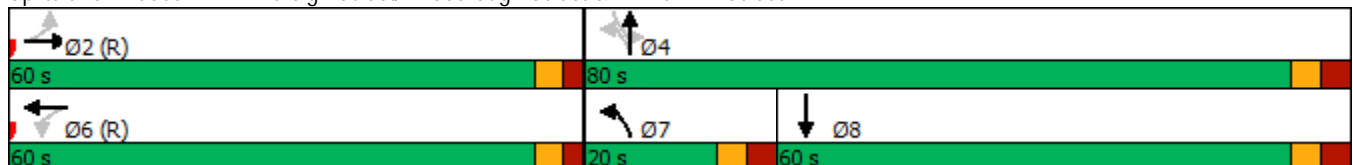

Lanes, Volumes, Timings

2020 Existing PM Peak

14: NC 86 (MLK Jr. Blvd) & Longview Street/Mill Creek Apts Driveway

Timing Plan: PM Peak

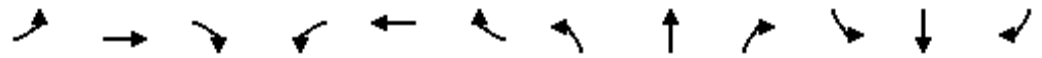

Lane Group	EBL	EBT	EBR	WBL	WBT	WBR	NBL	NBT	NBR	SBL	SBT	SBR
Lane Configurations		↕			↕		↕	↕		↕	↕	
Traffic Volume (vph)	94	2	18	33	1	8	14	832	13	11	624	75
Future Volume (vph)	94	2	18	33	1	8	14	832	13	11	624	75
Ideal Flow (vphpl)	1900	1900	1900	1900	1900	1900	1900	1900	1900	1900	1900	1900
Grade (%)		-6%			1%			2%			-4%	
Storage Length (ft)	0		0	0		0	225		0	250		0
Storage Lanes	0		0	0		0	1		0	1		0
Taper Length (ft)	25			25			25			25		
Lane Util. Factor	1.00	1.00	1.00	1.00	1.00	1.00	1.00	0.95	0.95	1.00	0.95	0.95
Ped Bike Factor		0.99			0.98		0.99	1.00		0.98	1.00	
Frt		0.979			0.973			0.998			0.984	
Flt Protected		0.960			0.962		0.950			0.950		
Satd. Flow (prot)	0	1794	0	0	1730	0	1735	3458	0	1787	3504	0
Flt Permitted		0.724			0.751		0.362			0.262		
Satd. Flow (perm)	0	1351	0	0	1334	0	657	3458	0	486	3504	0
Right Turn on Red			No			No			No			No
Satd. Flow (RTOR)												
Link Speed (mph)		25			20			35			35	
Link Distance (ft)		451			338			2108			784	
Travel Time (s)		12.3			11.5			41.1			15.3	
Confl. Peds. (#/hr)	2		20	20		2	7		28	28		7
Peak Hour Factor	0.89	0.89	0.89	0.75	0.75	0.75	0.86	0.86	0.86	0.93	0.93	0.93
Heavy Vehicles (%)	2%	2%	2%	2%	2%	2%	3%	3%	3%	3%	3%	3%
Adj. Flow (vph)	106	2	20	44	1	11	16	967	15	12	671	81
Shared Lane Traffic (%)												
Lane Group Flow (vph)	0	128	0	0	56	0	16	982	0	12	752	0
Turn Type	Perm	NA		Perm	NA		Perm	NA		Perm	NA	
Protected Phases		4			8			2			6	
Permitted Phases	4			8			2			6		
Detector Phase	4	4		8	8		2	2		6	6	
Switch Phase												
Minimum Initial (s)	7.0	7.0		7.0	7.0		12.0	12.0		12.0	12.0	
Minimum Split (s)	31.0	31.0		14.0	14.0		28.0	28.0		28.0	28.0	
Total Split (s)	20.0	20.0		20.0	20.0		60.0	60.0		60.0	60.0	
Total Split (%)	25.0%	25.0%		25.0%	25.0%		75.0%	75.0%		75.0%	75.0%	
Maximum Green (s)	14.0	14.0		13.9	13.9		54.0	54.0		54.5	54.5	
Yellow Time (s)	3.5	3.5		3.0	3.0		4.5	4.5		4.0	4.0	
All-Red Time (s)	2.5	2.5		3.1	3.1		1.5	1.5		1.5	1.5	
Lost Time Adjust (s)		-1.0			-1.0		-1.0	-1.0		-0.5	-0.5	
Total Lost Time (s)		5.0			5.1		5.0	5.0		5.0	5.0	
Lead/Lag												
Lead-Lag Optimize?												
Vehicle Extension (s)	3.0	3.0		3.0	3.0		3.0	3.0		3.0	3.0	
Recall Mode	None	None		None	None		Min	Min		Min	Min	
Walk Time (s)	7.0	7.0					7.0	7.0		7.0	7.0	
Flash Dont Walk (s)	17.0	17.0					9.0	9.0		9.0	9.0	
Pedestrian Calls (#/hr)	0	0					0	0		0	0	
Act Effct Green (s)		10.6			10.6		26.1	26.1		26.1	26.1	
Actuated g/C Ratio		0.25			0.25		0.62	0.62		0.62	0.62	

Lanes, Volumes, Timings
 14: NC 86 (MLK Jr. Blvd) & Longview Street/Mill Creek Apts Driveway

2020 Existing PM Peak
 Timing Plan: PM Peak



Lane Group	EBL	EBT	EBR	WBL	WBT	WBR	NBL	NBT	NBR	SBL	SBT	SBR
v/c Ratio		0.38			0.17		0.04	0.46		0.04	0.35	
Control Delay		18.3			15.5		6.0	7.4		6.1	6.6	
Queue Delay		0.0			0.0		0.0	0.0		0.0	0.0	
Total Delay		18.3			15.5		6.0	7.4		6.1	6.6	
LOS		B			B		A	A		A	A	
Approach Delay		18.3			15.5			7.4			6.6	
Approach LOS		B			B			A			A	
Queue Length 50th (ft)		25			10		2	71		1	49	
Queue Length 95th (ft)		71			30		9	128		8	97	
Internal Link Dist (ft)		371			258			2028			704	
Turn Bay Length (ft)							225			250		
Base Capacity (vph)		493			483		657	3458		486	3504	
Starvation Cap Reductn		0			0		0	0		0	0	
Spillback Cap Reductn		0			0		0	0		0	0	
Storage Cap Reductn		0			0		0	0		0	0	
Reduced v/c Ratio		0.26			0.12		0.02	0.28		0.02	0.21	

Intersection Summary

Area Type: Other
 Cycle Length: 80
 Actuated Cycle Length: 42.4
 Natural Cycle: 60
 Control Type: Actuated-Uncoordinated
 Maximum v/c Ratio: 0.46
 Intersection Signal Delay: 8.0
 Intersection LOS: A
 Intersection Capacity Utilization 45.3%
 ICU Level of Service A
 Analysis Period (min) 15

Splits and Phases: 14: NC 86 (MLK Jr. Blvd) & Longview Street/Mill Creek Apts Driveway

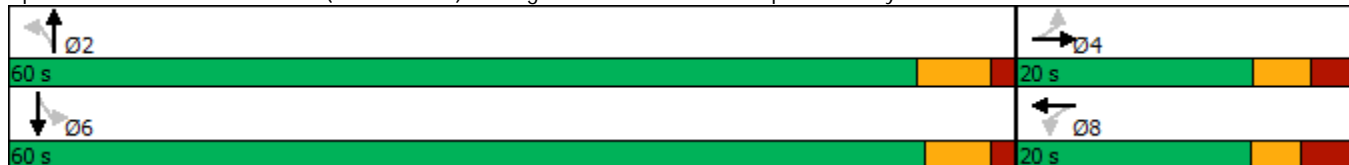

Lanes, Volumes, Timings
 15: NC 86 (Pittsboro St) & W. Cameron Avenue

2020 Existing PM Peak
 Timing Plan: PM Peak



Lane Group	EBT	EBR	WBL	WBT	NBL	NBR	Ø1	Ø4
Lane Configurations	↻		↻↻	↻				
Traffic Volume (vph)	144	216	496	349	0	0		
Future Volume (vph)	144	216	496	349	0	0		
Ideal Flow (vphpl)	1900	1900	1900	1900	1900	1900		
Lane Width (ft)	12	12	11	12	12	12		
Grade (%)	3%			-3%	0%			
Storage Length (ft)		0	75		0	0		
Storage Lanes		0	0		0	0		
Taper Length (ft)			25		25			
Lane Util. Factor	1.00	1.00	0.97	1.00	1.00	1.00		
Ped Bike Factor	0.84		0.74					
Frt	0.919							
Flt Protected			0.950					
Satd. Flow (prot)	1268	0	2890	1622	0	0		
Flt Permitted			0.950					
Satd. Flow (perm)	1268	0	2138	1622	0	0		
Right Turn on Red		No				No		
Satd. Flow (RTOR)								
Link Speed (mph)	25			25	25			
Link Distance (ft)	391			120	794			
Travel Time (s)	30.0			10.7	21.7			
Confl. Peds. (#/hr)		70	70					
Peak Hour Factor	0.93	0.93	0.96	0.96	0.90	0.90		
Heavy Vehicles (%)	2%	2%	7%	7%	2%	2%		
Adj. Flow (vph)	155	232	517	364	0	0		
Shared Lane Traffic (%)								
Lane Group Flow (vph)	387	0	517	364	0	0		
Turn Type	NA		Prot	NA				
Protected Phases	2		1 4	6			1	4
Permitted Phases								
Detector Phase	2		1 4	6				
Switch Phase								
Minimum Initial (s)	10.0			10.0			7.0	7.0
Minimum Split (s)	20.1			20.0			20.0	21.0
Total Split (s)	52.0			119.0			67.0	21.0
Total Split (%)	37.1%			85.0%			48%	15%
Maximum Green (s)	46.9			114.0			61.9	17.0
Yellow Time (s)	3.0			3.3			3.0	3.0
All-Red Time (s)	2.1			1.7			2.1	1.0
Lost Time Adjust (s)	-0.1			0.0				
Total Lost Time (s)	5.0			5.0				
Lead/Lag	Lead						Lag	
Lead-Lag Optimize?								
Vehicle Extension (s)	1.0			1.0			4.0	0.2
Recall Mode	None			C-Max			C-Max	None
Walk Time (s)	7.0							7.0
Flash Dont Walk (s)	4.0							9.0
Pedestrian Calls (#/hr)	0							0
Act Effect Green (s)	48.0		82.0	124.0				

Lanes, Volumes, Timings
 15: NC 86 (Pittsboro St) & W. Cameron Avenue

2020 Existing PM Peak
 Timing Plan: PM Peak



Lane Group	EBT	EBR	WBL	WBT	NBL	NBR	Ø1	Ø4
Actuated g/C Ratio	0.34		0.59	0.89				
v/c Ratio	0.89		0.31	0.25				
Control Delay	66.0		24.1	1.7				
Queue Delay	0.0		0.3	0.8				
Total Delay	66.0		24.4	2.5				
LOS	E		C	A				
Approach Delay	66.0			15.4				
Approach LOS	E			B				
Queue Length 50th (ft)	328		175	41				
Queue Length 95th (ft)	436		m238	m46				
Internal Link Dist (ft)	311			40	714			
Turn Bay Length (ft)			75					
Base Capacity (vph)	458		1899	1436				
Starvation Cap Reductn	0		803	753				
Spillback Cap Reductn	0		0	0				
Storage Cap Reductn	0		0	0				
Reduced v/c Ratio	0.84		0.47	0.53				

Intersection Summary

Area Type: CBD
 Cycle Length: 140
 Actuated Cycle Length: 140
 Offset: 6 (4%), Referenced to phase 1:WBL and 6:WBT, Start of Green
 Natural Cycle: 70
 Control Type: Actuated-Coordinated
 Maximum v/c Ratio: 0.89
 Intersection Signal Delay: 30.8 Intersection LOS: C
 Intersection Capacity Utilization 50.1% ICU Level of Service A
 Analysis Period (min) 15
 m Volume for 95th percentile queue is metered by upstream signal.

Splits and Phases: 15: NC 86 (Pittsboro St) & W. Cameron Avenue

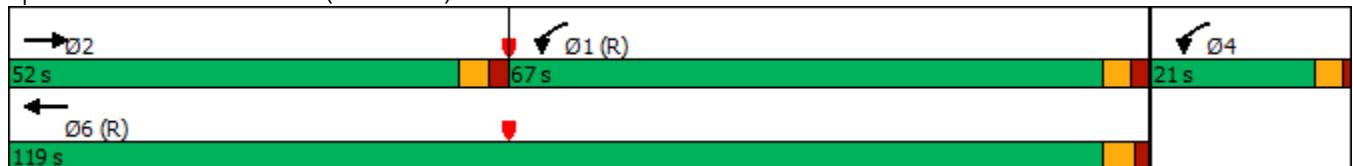

Lanes, Volumes, Timings

2020 Existing PM Peak

16: NC 86 (S. Columbia St) & W. Cameron Avenue/E. Cameron Avenue

Timing Plan: PM Peak

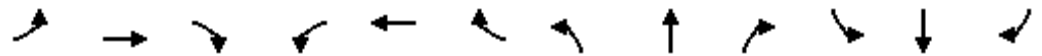

Lane Group	EBL	EBT	EBR	WBL	WBT	WBR	NBL	NBT	NBR	SBL	SBT	SBR
Lane Configurations												
Traffic Volume (vph)	19	120	0	0	163	50	216	630	58	117	0	455
Future Volume (vph)	19	120	0	0	163	50	216	630	58	117	0	455
Ideal Flow (vphpl)	1900	1900	1900	1900	1900	1900	1900	1900	1900	1900	1900	1900
Lane Width (ft)	11	12	12	12	12	12	10	10	10	11	11	12
Grade (%)		1%			-1%			1%			2%	
Storage Length (ft)	100		0	0		0	0		0	310		0
Storage Lanes	1		0	0		0	1		0	1		2
Taper Length (ft)	25			25			25			25		
Lane Util. Factor	1.00	1.00	1.00	1.00	1.00	1.00	0.91	0.91	0.95	1.00	1.00	0.88
Ped Bike Factor	0.85				0.93		0.68	0.93		0.78		0.60
Frt					0.968			0.988				0.850
Flt Protected	0.950						0.950	0.998		0.950		
Satd. Flow (prot)	1532	1668	0	0	1493	0	1295	2535	0	1453	0	2367
Flt Permitted	0.304						0.950	0.998		0.950		
Satd. Flow (perm)	418	1668	0	0	1493	0	884	2510	0	1130	0	1418
Right Turn on Red			No			No			No			No
Satd. Flow (RTOR)												
Link Speed (mph)		25			25			25				25
Link Distance (ft)		273			989			826				981
Travel Time (s)		10.7			57.6			22.5				26.8
Confl. Peds. (#/hr)	157		172	172		157	111		248	248		111
Peak Hour Factor	0.91	0.91	0.91	0.90	0.90	0.90	0.87	0.87	0.87	0.85	0.85	0.85
Heavy Vehicles (%)	2%	2%	2%	4%	4%	4%	6%	6%	6%	7%	7%	7%
Adj. Flow (vph)	21	132	0	0	181	56	248	724	67	138	0	535
Shared Lane Traffic (%)							10%					
Lane Group Flow (vph)	21	132	0	0	237	0	223	816	0	138	0	535
Turn Type	Perm	NA			NA		Split	NA		Prot		Prot
Protected Phases		4			8		2	2		1		1
Permitted Phases	4									1		1
Detector Phase	4	4			8		2	2		1		1
Switch Phase												
Minimum Initial (s)	10.0	10.0			10.0		7.0	7.0		7.0		7.0
Minimum Split (s)	24.0	24.0			31.0		18.0	18.0		26.0		26.0
Total Split (s)	31.0	31.0			31.0		46.0	46.0		35.0		35.0
Total Split (%)	22.1%	22.1%			22.1%		32.9%	32.9%		25.0%		25.0%
Maximum Green (s)	24.8	24.8			24.8		40.1	40.1		29.4		29.4
Yellow Time (s)	3.2	3.2			3.2		3.1	3.1		3.0		3.0
All-Red Time (s)	3.0	3.0			3.0		2.8	2.8		2.6		2.6
Lost Time Adjust (s)	-1.2	-1.2			-1.2		-0.9	-0.9		-0.6		-0.6
Total Lost Time (s)	5.0	5.0			5.0		5.0	5.0		5.0		5.0
Lead/Lag							Lag	Lag		Lead		Lead
Lead-Lag Optimize?							Yes	Yes		Yes		Yes
Vehicle Extension (s)	2.0	2.0			2.0		4.0	4.0		4.0		4.0
Recall Mode	None	None			None		C-Max	C-Max		None		None
Walk Time (s)	7.0	7.0			7.0		7.0	7.0		7.0		7.0
Flash Dont Walk (s)	10.0	10.0			17.0		5.0	5.0		13.0		13.0
Pedestrian Calls (#/hr)	0	0			0		0	0		0		0
Act Effect Green (s)	24.8	24.8			24.8		56.0	56.0		44.2		44.2

Lane Group	Ø9
Lane Configurations	
Traffic Volume (vph)	
Future Volume (vph)	
Ideal Flow (vphpl)	
Lane Width (ft)	
Grade (%)	
Storage Length (ft)	
Storage Lanes	
Taper Length (ft)	
Lane Util. Factor	
Ped Bike Factor	
Frt	
Flt Protected	
Satd. Flow (prot)	
Flt Permitted	
Satd. Flow (perm)	
Right Turn on Red	
Satd. Flow (RTOR)	
Link Speed (mph)	
Link Distance (ft)	
Travel Time (s)	
Confl. Peds. (#/hr)	
Peak Hour Factor	
Heavy Vehicles (%)	
Adj. Flow (vph)	
Shared Lane Traffic (%)	
Lane Group Flow (vph)	
Turn Type	
Protected Phases	9
Permitted Phases	
Detector Phase	
Switch Phase	
Minimum Initial (s)	7.0
Minimum Split (s)	28.0
Total Split (s)	28.0
Total Split (%)	20%
Maximum Green (s)	24.0
Yellow Time (s)	3.0
All-Red Time (s)	1.0
Lost Time Adjust (s)	
Total Lost Time (s)	
Lead/Lag	
Lead-Lag Optimize?	
Vehicle Extension (s)	0.2
Recall Mode	None
Walk Time (s)	7.0
Flash Dont Walk (s)	17.0
Pedestrian Calls (#/hr)	0
Act Effect Green (s)	

Lanes, Volumes, Timings

2020 Existing PM Peak

16: NC 86 (S. Columbia St) & W. Cameron Avenue/E. Cameron Avenue

Timing Plan: PM Peak

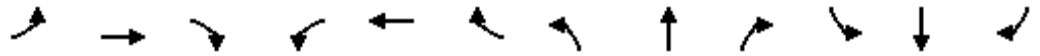

Lane Group	EBL	EBT	EBR	WBL	WBT	WBR	NBL	NBT	NBR	SBL	SBT	SBR
Actuated g/C Ratio	0.18	0.18			0.18		0.40	0.40		0.32		0.32
v/c Ratio	0.29	0.45			0.90		0.43	0.80		0.30		0.72
Control Delay	74.7	73.7			90.3		34.4	45.0		30.4		36.3
Queue Delay	0.0	0.0			0.0		0.0	0.0		0.0		0.0
Total Delay	74.7	73.7			90.3		34.4	45.0		30.4		36.3
LOS	E	E			F		C	D		C		D
Approach Delay		73.9			90.3			42.7				35.1
Approach LOS		E			F			D				D
Queue Length 50th (ft)	20	129			211		161	359		56		125
Queue Length 95th (ft)	m24	m152			#360		245	444		92		163
Internal Link Dist (ft)		193			909			746				901
Turn Bay Length (ft)	100									310		
Base Capacity (vph)	77	309			277		518	1014		458		746
Starvation Cap Reductn	0	0			0		0	0		0		0
Spillback Cap Reductn	0	0			0		0	0		0		0
Storage Cap Reductn	0	0			0		0	0		0		0
Reduced v/c Ratio	0.27	0.43			0.86		0.43	0.80		0.30		0.72

Intersection Summary

Area Type: CBD
 Cycle Length: 140
 Actuated Cycle Length: 140
 Offset: 0 (0%), Referenced to phase 2:NBTL, Start of Green
 Natural Cycle: 145
 Control Type: Actuated-Coordinated
 Maximum v/c Ratio: 0.90
 Intersection Signal Delay: 47.9 Intersection LOS: D
 Intersection Capacity Utilization 76.6% ICU Level of Service D
 Analysis Period (min) 15
 # 95th percentile volume exceeds capacity, queue may be longer.
 Queue shown is maximum after two cycles.
 m Volume for 95th percentile queue is metered by upstream signal.

Splits and Phases: 16: NC 86 (S. Columbia St) & W. Cameron Avenue/E. Cameron Avenue

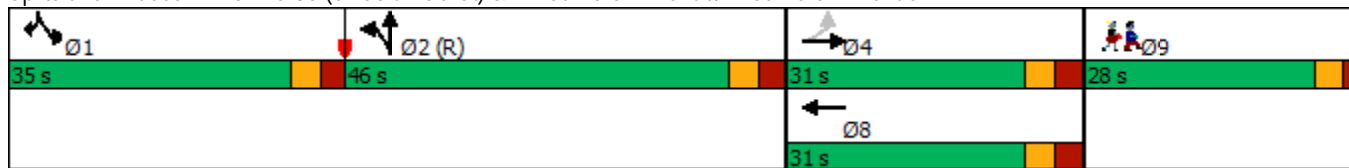

Lane Group	Ø9
Actuated g/C Ratio	
v/c Ratio	
Control Delay	
Queue Delay	
Total Delay	
LOS	
Approach Delay	
Approach LOS	
Queue Length 50th (ft)	
Queue Length 95th (ft)	
Internal Link Dist (ft)	
Turn Bay Length (ft)	
Base Capacity (vph)	
Starvation Cap Reductn	
Spillback Cap Reductn	
Storage Cap Reductn	
Reduced v/c Ratio	
Intersection Summary	

Lanes, Volumes, Timings
 17: Raleigh Street & E. Cameron Avenue/Country Club Road

2020 Existing PM Peak
 Timing Plan: PM Peak



Lane Group	EBL	EBT	EBR	WBL	WBT	WBR	NBL	NBT	NBR	SBL	SBT	SBR
Lane Configurations		↕		↖	↗		↖	↗		↖	↗	
Traffic Volume (vph)	26	159	46	34	126	168	54	86	60	266	180	52
Future Volume (vph)	26	159	46	34	126	168	54	86	60	266	180	52
Ideal Flow (vphpl)	1900	1900	1900	1900	1900	1900	1900	1900	1900	1900	1900	1900
Grade (%)		-3%			3%			-2%				1%
Storage Length (ft)	0		0	150		0	125		0	75		0
Storage Lanes	0		0	1		0	1		0	1		0
Taper Length (ft)	25			25			25			25		
Lane Util. Factor	1.00	1.00	1.00	1.00	1.00	1.00	1.00	1.00	1.00	1.00	1.00	1.00
Ped Bike Factor		0.94			0.88			0.88		0.81	0.88	
Frt		0.973			0.914			0.939			0.966	
Flt Protected		0.994		0.950			0.950			0.950		
Satd. Flow (prot)	0	1572	0	1569	1334	0	1563	1354	0	1585	1415	0
Flt Permitted		0.927		0.374			0.590			0.460		
Satd. Flow (perm)	0	1446	0	618	1334	0	970	1354	0	622	1415	0
Right Turn on Red			No			No			No			No
Satd. Flow (RTOR)												
Link Speed (mph)		25			25			25				25
Link Distance (ft)		598			651			409				995
Travel Time (s)		16.3			17.8			11.2				27.1
Confl. Peds. (#/hr)	39		37	37		39	107		60	60		107
Peak Hour Factor	0.75	0.75	0.75	0.89	0.89	0.89	0.89	0.89	0.89	0.84	0.84	0.84
Heavy Vehicles (%)	2%	2%	2%	2%	2%	2%	5%	5%	5%	2%	2%	2%
Adj. Flow (vph)	35	212	61	38	142	189	61	97	67	317	214	62
Shared Lane Traffic (%)												
Lane Group Flow (vph)	0	308	0	38	331	0	61	164	0	317	276	0
Turn Type	Perm	NA		pm+pt	NA		pm+pt	NA		pm+pt	NA	
Protected Phases		2		1	6		3	8		7	4	
Permitted Phases	2			6			8			4		
Detector Phase	2	2		1	6		3	8		7	4	
Switch Phase												
Minimum Initial (s)	10.0	10.0		7.0	10.0		7.0	7.0		7.0	7.0	
Minimum Split (s)	18.0	18.0		13.0	19.0		13.0	19.0		12.0	16.0	
Total Split (s)	50.0	50.0		20.0	70.0		20.0	35.0		20.0	35.0	
Total Split (%)	40.0%	40.0%		16.0%	56.0%		16.0%	28.0%		16.0%	28.0%	
Maximum Green (s)	43.9	43.9		14.4	64.4		14.7	29.7		15.1	29.9	
Yellow Time (s)	3.3	3.3		3.0	3.1		3.0	3.1		3.0	3.1	
All-Red Time (s)	2.8	2.8		2.6	2.5		2.3	2.2		1.9	2.0	
Lost Time Adjust (s)		-1.1		-0.6	-0.6		-0.3	-0.3		0.1	-0.1	
Total Lost Time (s)		5.0		5.0	5.0		5.0	5.0		5.0	5.0	
Lead/Lag	Lag	Lag		Lead			Lead	Lag		Lead	Lag	
Lead-Lag Optimize?	Yes	Yes		Yes			Yes	Yes		Yes	Yes	
Vehicle Extension (s)	2.0	2.0		2.0	2.0		2.0	2.0		2.0	2.0	
Recall Mode	None	None		None	None		None	None		None	None	
Walk Time (s)	4.0	4.0			4.0			4.0			4.0	
Flash Dont Walk (s)	7.0	7.0			9.0			9.0			6.0	
Pedestrian Calls (#/hr)	0	0			0			0			0	
Act Effect Green (s)		23.4		29.8	29.8		23.2	14.9		35.8	26.1	
Actuated g/C Ratio		0.31		0.39	0.39		0.30	0.19		0.47	0.34	

Lanes, Volumes, Timings
 17: Raleigh Street & E. Cameron Avenue/Country Club Road

2020 Existing PM Peak
 Timing Plan: PM Peak



Lane Group	EBL	EBT	EBR	WBL	WBT	WBR	NBL	NBT	NBR	SBL	SBT	SBR
v/c Ratio		0.70		0.11	0.64		0.17	0.62		0.65	0.57	
Control Delay		34.7		14.9	24.6		17.3	42.7		25.1	32.1	
Queue Delay		0.0		0.0	0.0		0.0	0.0		0.0	0.0	
Total Delay		34.7		14.9	24.6		17.3	42.7		25.1	32.1	
LOS		C		B	C		B	D		C	C	
Approach Delay		34.7			23.6			35.8			28.4	
Approach LOS		C			C			D			C	
Queue Length 50th (ft)		140		11	119		18	78		112	126	
Queue Length 95th (ft)		205		31	230		49	162		#214	234	
Internal Link Dist (ft)		518			571			329			915	
Turn Bay Length (ft)				150			125			75		
Base Capacity (vph)		924		450	1104		521	577		496	603	
Starvation Cap Reductn		0		0	0		0	0		0	0	
Spillback Cap Reductn		0		0	0		0	0		0	0	
Storage Cap Reductn		0		0	0		0	0		0	0	
Reduced v/c Ratio		0.33		0.08	0.30		0.12	0.28		0.64	0.46	

Intersection Summary

Area Type: CBD
 Cycle Length: 125
 Actuated Cycle Length: 76.5
 Natural Cycle: 70
 Control Type: Actuated-Uncoordinated
 Maximum v/c Ratio: 0.70
 Intersection Signal Delay: 29.6
 Intersection LOS: C
 Intersection Capacity Utilization 77.8%
 ICU Level of Service D
 Analysis Period (min) 15
 # 95th percentile volume exceeds capacity, queue may be longer.
 Queue shown is maximum after two cycles.

Splits and Phases: 17: Raleigh Street & E. Cameron Avenue/Country Club Road

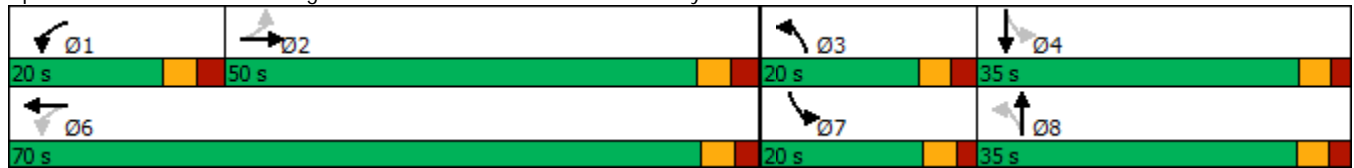



2022 Without Parking Deck Site

Lanes, Volumes, Timings
1: Church Street & W. Rosemary Street

09/01/2020



Lane Group	EBL	EBT	EBR	WBL	WBT	WBR	NBL	NBT	NBR	SBL	SBT	SBR
Lane Configurations		↕			↕			↕			↕	
Traffic Volume (vph)	14	288	21	32	300	15	33	24	36	27	39	11
Future Volume (vph)	14	288	21	32	300	15	33	24	36	27	39	11
Ideal Flow (vphpl)	1900	1900	1900	1900	1900	1900	1900	1900	1900	1900	1900	1900
Lane Width (ft)	12	14	12	12	14	12	12	12	12	12	12	12
Grade (%)		1%			-1%			0%			0%	
Lane Util. Factor	1.00	1.00	1.00	1.00	1.00	1.00	1.00	1.00	1.00	1.00	1.00	1.00
Ped Bike Factor		0.99			0.99			0.95			0.97	
Frt		0.991			0.994			0.948			0.981	
Flt Protected		0.998			0.995			0.983			0.983	
Satd. Flow (prot)	0	1734	0	0	1737	0	0	1511	0	0	1602	0
Flt Permitted		0.982			0.950			0.880			0.877	
Satd. Flow (perm)	0	1704	0	0	1655	0	0	1334	0	0	1401	0
Right Turn on Red			No			No			No			No
Satd. Flow (RTOR)												
Link Speed (mph)		20			20			25			25	
Link Distance (ft)		964			757			379			430	
Travel Time (s)		32.9			25.8			10.3			11.7	
Confl. Peds. (#/hr)	20		17	17		20	21		31	31		21
Peak Hour Factor	0.86	0.86	0.86	0.89	0.89	0.89	0.84	0.84	0.84	0.72	0.72	0.72
Heavy Vehicles (%)	3%	3%	3%	4%	4%	4%	2%	2%	2%	2%	2%	2%
Adj. Flow (vph)	16	335	24	36	337	17	39	29	43	38	54	15
Shared Lane Traffic (%)												
Lane Group Flow (vph)	0	375	0	0	390	0	0	111	0	0	107	0
Turn Type	Perm	NA		Perm	NA		Perm	NA		Perm	NA	
Protected Phases		2			6			8			4	
Permitted Phases	2			6			8			4		
Detector Phase	2	2		6	6		8	8		4	4	
Switch Phase												
Minimum Initial (s)	10.0	10.0		10.0	10.0		7.0	7.0		7.0	7.0	
Minimum Split (s)	19.0	19.0		20.0	20.0		19.0	19.0		19.0	19.0	
Total Split (s)	38.0	38.0		38.0	38.0		22.0	22.0		22.0	22.0	
Total Split (%)	63.3%	63.3%		63.3%	63.3%		36.7%	36.7%		36.7%	36.7%	
Maximum Green (s)	33.5	33.5		33.4	33.4		17.1	17.1		17.1	17.1	
Yellow Time (s)	3.1	3.1		3.1	3.1		3.2	3.2		3.2	3.2	
All-Red Time (s)	1.4	1.4		1.5	1.5		1.7	1.7		1.7	1.7	
Lost Time Adjust (s)		0.5			0.4			0.1			0.1	
Total Lost Time (s)		5.0			5.0			5.0			5.0	
Lead/Lag												
Lead-Lag Optimize?												
Vehicle Extension (s)	3.0	3.0		3.0	3.0		3.0	3.0		3.0	3.0	
Recall Mode	C-Max	C-Max		C-Max	C-Max		None	None		None	None	
Walk Time (s)	4.0	4.0		4.0	4.0		4.0	4.0		4.0	4.0	
Flash Dont Walk (s)	5.0	5.0		6.0	6.0		10.0	10.0		10.0	10.0	
Pedestrian Calls (#/hr)	0	0		0	0		0	0		0	0	
Act Effct Green (s)		43.0			43.0			10.4			10.4	
Actuated g/C Ratio		0.72			0.72			0.17			0.17	
v/c Ratio		0.31			0.33			0.48			0.44	
Control Delay		5.7			3.3			24.6			27.1	

Lanes, Volumes, Timings
 1: Church Street & W. Rosemary Street

09/01/2020



Lane Group	EBL	EBT	EBR	WBL	WBT	WBR	NBL	NBT	NBR	SBL	SBT	SBR
Queue Delay		0.0			0.0			0.0			0.0	
Total Delay		5.7			3.3			24.6			27.1	
LOS		A			A			C			C	
Approach Delay		5.7			3.3			24.6			27.1	
Approach LOS		A			A			C			C	
Queue Length 50th (ft)		48			18			37			35	
Queue Length 95th (ft)		102			48			53			54	
Internal Link Dist (ft)		884			677			299			350	
Turn Bay Length (ft)												
Base Capacity (vph)		1220			1185			377			396	
Starvation Cap Reductn		0			0			0			0	
Spillback Cap Reductn		0			0			0			0	
Storage Cap Reductn		0			0			0			0	
Reduced v/c Ratio		0.31			0.33			0.29			0.27	

Intersection Summary

Area Type:	CBD
Cycle Length:	60
Actuated Cycle Length:	60
Offset:	7 (12%), Referenced to phase 2:EBTL and 6:WBTL, Start of Green
Natural Cycle:	40
Control Type:	Actuated-Coordinated
Maximum v/c Ratio:	0.48
Intersection Signal Delay:	9.2
Intersection LOS:	A
Intersection Capacity Utilization:	51.2%
ICU Level of Service:	A
Analysis Period (min):	15

Splits and Phases: 1: Church Street & W. Rosemary Street

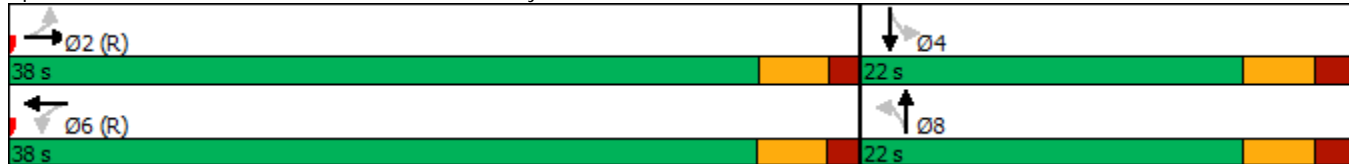

Lanes, Volumes, Timings

2: NC 86 (N. Columbia St) & W. Rosemary Street/E. Rosemary Street

09/01/2020



Lane Group	EBL	EBT	EBR	WBL	WBT	WBR	NBL	NBT	NBR	SBL	SBT	SBR
Lane Configurations												
Traffic Volume (vph)	150	205	21	13	165	32	22	309	34	77	559	176
Future Volume (vph)	150	205	21	13	165	32	22	309	34	77	559	176
Ideal Flow (vphpl)	1900	1900	1900	1900	1900	1900	1900	1900	1900	1900	1900	1900
Lane Width (ft)	9	12	13	12	12	12	9	10	12	12	9	11
Grade (%)		1%			1%			-2%			8%	
Storage Length (ft)	100		0	150		0	75		0	150		400
Storage Lanes	1		0	1		0	1		0	1		1
Taper Length (ft)	25			25			25			25		
Lane Util. Factor	1.00	1.00	1.00	1.00	1.00	1.00	1.00	0.95	0.95	1.00	0.95	1.00
Ped Bike Factor	0.99	1.00		0.98	1.00		0.98	0.99		0.94		0.91
Frt		0.986			0.975			0.985				0.850
Flt Protected	0.950			0.950			0.950			0.950		
Satd. Flow (prot)	1426	1640	0	1585	1619	0	1355	2730	0	1485	2673	1285
Flt Permitted	0.286			0.597			0.364			0.473		
Satd. Flow (perm)	425	1640	0	980	1619	0	510	2730	0	694	2673	1169
Right Turn on Red			No			No			No			No
Satd. Flow (RTOR)												
Link Speed (mph)		20			20			25			25	
Link Distance (ft)		757			339			353			476	
Travel Time (s)		25.8			11.6			9.6			13.0	
Confl. Peds. (#/hr)	12		16	16		12	19		34	34		19
Peak Hour Factor	0.86	0.86	0.86	0.90	0.90	0.90	0.90	0.90	0.90	0.88	0.88	0.88
Heavy Vehicles (%)	2%	2%	2%	2%	2%	2%	9%	9%	9%	5%	5%	5%
Adj. Flow (vph)	174	238	24	14	183	36	24	343	38	88	635	200
Shared Lane Traffic (%)												
Lane Group Flow (vph)	174	262	0	14	219	0	24	381	0	88	635	200
Turn Type	pm+pt	NA		Perm	NA		pm+pt	NA		pm+pt	NA	pm+ov
Protected Phases	7	4			8		5	2		1	6	7
Permitted Phases	4			8			2			6		6
Detector Phase	7	4		8	8		5	2		1	6	7
Switch Phase												
Minimum Initial (s)	7.0	7.0		7.0	7.0		7.0	10.0		7.0	10.0	7.0
Minimum Split (s)	13.0	31.0		32.0	32.0		13.0	23.0		13.0	22.0	13.0
Total Split (s)	23.0	57.0		34.0	34.0		13.0	50.0		13.0	50.0	23.0
Total Split (%)	19.2%	47.5%		28.3%	28.3%		10.8%	41.7%		10.8%	41.7%	19.2%
Maximum Green (s)	17.2	51.0		28.0	28.0		7.2	44.2		7.9	44.2	17.2
Yellow Time (s)	3.0	3.2		3.2	3.2		3.0	3.3		3.0	3.3	3.0
All-Red Time (s)	2.8	2.8		2.8	2.8		2.8	2.5		2.1	2.5	2.8
Lost Time Adjust (s)	-0.8	-1.0		-1.0	-1.0		-1.0	-0.8		-0.1	-0.8	-0.8
Total Lost Time (s)	5.0	5.0		5.0	5.0		4.8	5.0		5.0	5.0	5.0
Lead/Lag	Lead			Lag	Lag		Lead	Lag		Lead	Lag	Lead
Lead-Lag Optimize?												
Vehicle Extension (s)	1.0	1.0		1.0	1.0		1.0	3.0		1.0	3.0	1.0
Recall Mode	None	None		None	None		None	C-Max		None	C-Max	None
Walk Time (s)		7.0		7.0	7.0			7.0			7.0	
Flash Dont Walk (s)		18.0		19.0	19.0			10.0			9.0	
Pedestrian Calls (#/hr)		0		0	0			0			0	
Act Effect Green (s)	41.6	41.6		20.7	20.7		63.9	55.7		65.5	60.7	76.6

Lanes, Volumes, Timings

2: NC 86 (N. Columbia St) & W. Rosemary Street/E. Rosemary Street

09/01/2020

Lane Group	EBL	EBT	EBR	WBL	WBT	WBR	NBL	NBT	NBR	SBL	SBT	SBR
Actuated g/C Ratio	0.35	0.35		0.17	0.17		0.53	0.46		0.55	0.51	0.64
v/c Ratio	0.62	0.46		0.08	0.78		0.07	0.30		0.21	0.47	0.26
Control Delay	38.8	33.5		36.2	58.8		11.0	14.1		15.3	23.7	10.8
Queue Delay	0.0	0.0		0.0	0.0		0.0	0.0		0.0	0.0	0.0
Total Delay	38.8	33.5		36.2	58.8		11.0	14.1		15.3	23.8	10.8
LOS	D	C		D	E		B	B		B	C	B
Approach Delay		35.6			57.5			13.9			20.2	
Approach LOS		D			E			B			C	
Queue Length 50th (ft)	104	162		8	136		5	54		31	184	62
Queue Length 95th (ft)	145	223		m26	199		m13	86		65	263	116
Internal Link Dist (ft)		677			259			273			396	
Turn Bay Length (ft)	100			150			75			150		400
Base Capacity (vph)	297	710		236	391		330	1266		433	1351	783
Starvation Cap Reductn	0	0		0	0		0	0		0	0	0
Spillback Cap Reductn	0	0		0	0		0	0		0	45	0
Storage Cap Reductn	0	0		0	0		0	0		0	0	0
Reduced v/c Ratio	0.59	0.37		0.06	0.56		0.07	0.30		0.20	0.49	0.26

Intersection Summary

Area Type:	CBD	
Cycle Length:	120	
Actuated Cycle Length:	120	
Offset:	41 (34%), Referenced to phase 2:NBTL and 6:SBTL, Start of Green	
Natural Cycle:	85	
Control Type:	Actuated-Coordinated	
Maximum v/c Ratio:	0.78	
Intersection Signal Delay:	26.6	Intersection LOS: C
Intersection Capacity Utilization	63.9%	ICU Level of Service B
Analysis Period (min)	15	
m	Volume for 95th percentile queue is metered by upstream signal.	

Splits and Phases: 2: NC 86 (N. Columbia St) & W. Rosemary Street/E. Rosemary Street

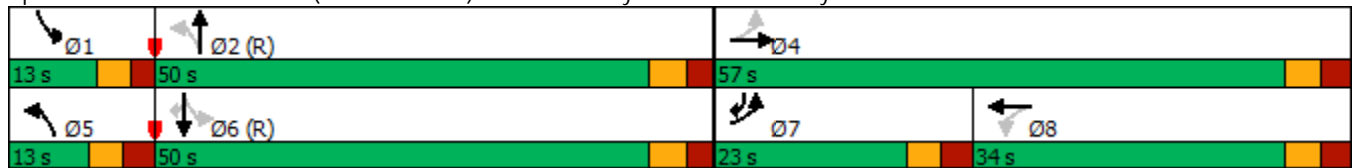

Lanes, Volumes, Timings
6: Henderson Street & E. Rosemary Street

09/01/2020



Lane Group	EBL	EBT	EBR	WBL	WBT	WBR	NBL	NBT	NBR	SBL	SBT	SBR
Lane Configurations												
Traffic Volume (vph)	5	138	62	8	279	16	53	6	8	9	16	5
Future Volume (vph)	5	138	62	8	279	16	53	6	8	9	16	5
Ideal Flow (vphpl)	1900	1900	1900	1900	1900	1900	1900	1900	1900	1900	1900	1900
Grade (%)		0%			0%			0%			3%	
Storage Length (ft)	85		0	0		0	0		0	0		0
Storage Lanes	1		0	0		0	0		0	0		0
Taper Length (ft)	25			25			25			25		
Lane Util. Factor	1.00	1.00	1.00	1.00	1.00	1.00	1.00	1.00	1.00	1.00	1.00	1.00
Ped Bike Factor	0.99	0.99			1.00			0.95			0.97	
Frt		0.953			0.993			0.984			0.979	
Flt Protected	0.950				0.999			0.962			0.985	
Satd. Flow (prot)	1593	1580	0	0	1660	0	0	1558	0	0	1559	0
Flt Permitted	0.562				0.993			0.741			0.882	
Satd. Flow (perm)	937	1580	0	0	1650	0	0	1155	0	0	1377	0
Right Turn on Red			No			No			No			No
Satd. Flow (RTOR)												
Link Speed (mph)		20			20			20			20	
Link Distance (ft)		156			1195			366			450	
Travel Time (s)		5.3			40.7			12.5			15.3	
Confl. Peds. (#/hr)	4		6	6		4	22		23	23		22
Peak Hour Factor	0.89	0.89	0.89	0.75	0.75	0.75	0.87	0.87	0.87	0.68	0.68	0.68
Heavy Vehicles (%)	2%	2%	2%	2%	2%	2%	3%	3%	3%	3%	3%	3%
Adj. Flow (vph)	6	155	70	11	372	21	61	7	9	13	24	7
Shared Lane Traffic (%)												
Lane Group Flow (vph)	6	225	0	0	404	0	0	77	0	0	44	0
Turn Type	Perm	NA		Perm	NA		Perm	NA		Perm	NA	
Protected Phases		2			2			4			4	
Permitted Phases	2			2			4			4		
Detector Phase	2	2		2	2		4	4		4	4	
Switch Phase												
Minimum Initial (s)	11.0	11.0		11.0	11.0		8.0	8.0		8.0	8.0	
Minimum Split (s)	15.9	15.9		15.9	15.9		17.8	17.8		17.8	17.8	
Total Split (s)	40.0	40.0		40.0	40.0		20.0	20.0		20.0	20.0	
Total Split (%)	66.7%	66.7%		66.7%	66.7%		33.3%	33.3%		33.3%	33.3%	
Maximum Green (s)	35.1	35.1		35.1	35.1		15.2	15.2		15.2	15.2	
Yellow Time (s)	3.3	3.3		3.3	3.3		3.3	3.3		3.3	3.3	
All-Red Time (s)	1.6	1.6		1.6	1.6		1.5	1.5		1.5	1.5	
Lost Time Adjust (s)	0.1	0.1			0.1			0.2			0.2	
Total Lost Time (s)	5.0	5.0			5.0			5.0			5.0	
Lead/Lag												
Lead-Lag Optimize?												
Vehicle Extension (s)	2.0	2.0		2.0	2.0		2.0	2.0		2.0	2.0	
Recall Mode	C-Max	C-Max		C-Max	C-Max		None	None		None	None	
Walk Time (s)	4.0	4.0		4.0	4.0		4.0	4.0		4.0	4.0	
Flash Dont Walk (s)	7.0	7.0		7.0	7.0		9.0	9.0		9.0	9.0	
Pedestrian Calls (#/hr)	0	0		0	0		0	0		0	0	
Act Effct Green (s)	44.4	44.4			44.4			9.1			9.1	
Actuated g/C Ratio	0.74	0.74			0.74			0.15			0.15	

Lanes, Volumes, Timings
 6: Henderson Street & E. Rosemary Street

09/01/2020



Lane Group	EBL	EBT	EBR	WBL	WBT	WBR	NBL	NBT	NBR	SBL	SBT	SBR
v/c Ratio	0.01	0.19			0.33			0.44				0.21
Control Delay	5.6	5.5			5.1			27.1				24.0
Queue Delay	0.0	0.0			0.0			0.0				0.0
Total Delay	5.6	5.5			5.1			27.1				24.0
LOS	A	A			A			C				C
Approach Delay		5.5			5.1			27.1				24.0
Approach LOS		A			A			C				C
Queue Length 50th (ft)	1	43			72			38				15
Queue Length 95th (ft)	m5	94			84			70				27
Internal Link Dist (ft)		76			1115			286				370
Turn Bay Length (ft)	85											
Base Capacity (vph)	693	1169			1221			288				344
Starvation Cap Reductn	0	0			0			0				0
Spillback Cap Reductn	0	0			0			0				0
Storage Cap Reductn	0	0			0			0				0
Reduced v/c Ratio	0.01	0.19			0.33			0.27				0.13

Intersection Summary

Area Type: CBD
 Cycle Length: 60
 Actuated Cycle Length: 60
 Offset: 38 (63%), Referenced to phase 2:EBWB, Start of Green
 Natural Cycle: 40
 Control Type: Actuated-Coordinated
 Maximum v/c Ratio: 0.44
 Intersection Signal Delay: 8.5
 Intersection LOS: A
 Intersection Capacity Utilization 43.3%
 ICU Level of Service A
 Analysis Period (min) 15
 m Volume for 95th percentile queue is metered by upstream signal.

Splits and Phases: 6: Henderson Street & E. Rosemary Street



Lanes, Volumes, Timings

7: Hillsborough Street & E. Rosemary Street

09/01/2020



Lane Group	EBL	EBT	EBR	WBL	WBT	WBR	NBL	NBT	NBR	SBL	SBT	SBR
Lane Configurations		↕			↕		↕	↕		↕	↕	
Traffic Volume (vph)	6	57	68	0	110	12	176	142	6	21	356	32
Future Volume (vph)	6	57	68	0	110	12	176	142	6	21	356	32
Ideal Flow (vphpl)	1900	1900	1900	1900	1900	1900	1900	1900	1900	1900	1900	1900
Storage Length (ft)	0		0	0		0	100		0	100		0
Storage Lanes	0		0	0		0	1		0	1		0
Taper Length (ft)	25			25			25			25		
Lane Util. Factor	1.00	1.00	1.00	1.00	1.00	1.00	1.00	1.00	1.00	1.00	1.00	1.00
Ped Bike Factor		0.99			1.00			1.00		1.00	1.00	
Frt		0.930			0.987			0.994			0.987	
Flt Protected		0.998					0.950			0.950		
Satd. Flow (prot)	0	1706	0	0	1832	0	1752	1832	0	1752	1812	0
Flt Permitted		0.979					0.364			0.656		
Satd. Flow (perm)	0	1672	0	0	1832	0	671	1832	0	1204	1812	0
Right Turn on Red			No			No			No			No
Satd. Flow (RTOR)												
Link Speed (mph)		20			20			25			25	
Link Distance (ft)		1195			527			363			726	
Travel Time (s)		40.7			18.0			9.9			19.8	
Confl. Peds. (#/hr)	6		3	3		6	13		2	2		13
Peak Hour Factor	0.82	0.82	0.82	0.71	0.71	0.71	0.93	0.93	0.93	0.90	0.90	0.90
Heavy Vehicles (%)	2%	2%	2%	2%	2%	2%	3%	3%	3%	3%	3%	3%
Adj. Flow (vph)	7	70	83	0	155	17	189	153	6	23	396	36
Shared Lane Traffic (%)												
Lane Group Flow (vph)	0	160	0	0	172	0	189	159	0	23	432	0
Turn Type	Perm	NA			NA		pm+pt	NA		Perm	NA	
Protected Phases		4			8		5	2			6	
Permitted Phases	4			8			2			6		
Detector Phase	4	4		8	8		5	2		6	6	
Switch Phase												
Minimum Initial (s)	7.0	7.0		7.0	7.0		7.0	10.0		10.0	10.0	
Minimum Split (s)	20.0	20.0		17.0	17.0		12.0	15.0		15.0	15.0	
Total Split (s)	20.0	20.0		20.0	20.0		12.0	40.0		28.0	28.0	
Total Split (%)	33.3%	33.3%		33.3%	33.3%		20.0%	66.7%		46.7%	46.7%	
Maximum Green (s)	15.1	15.1		15.0	15.0		7.2	35.2		23.2	23.2	
Yellow Time (s)	3.0	3.0		3.3	3.3		3.0	3.3		3.1	3.1	
All-Red Time (s)	1.9	1.9		1.7	1.7		1.8	1.5		1.7	1.7	
Lost Time Adjust (s)		0.1			0.0		0.2	0.2		0.2	0.2	
Total Lost Time (s)		5.0			5.0		5.0	5.0		5.0	5.0	
Lead/Lag							Lead			Lag	Lag	
Lead-Lag Optimize?							Yes			Yes	Yes	
Vehicle Extension (s)	2.0	2.0		2.0	2.0		2.0	2.0		2.0	2.0	
Recall Mode	None	None		None	None		None	C-Max		C-Max	C-Max	
Walk Time (s)	4.0	4.0		4.0	4.0			4.0		4.0	4.0	
Flash Dont Walk (s)	11.0	11.0		8.0	8.0			6.0		6.0	6.0	
Pedestrian Calls (#/hr)	0	0		0	0			0		0	0	
Act Effct Green (s)		10.2			10.2		42.2	43.2		30.0	30.0	
Actuated g/C Ratio		0.17			0.17		0.70	0.72		0.50	0.50	
v/c Ratio		0.56			0.55		0.32	0.12		0.04	0.48	

Lanes, Volumes, Timings
 7: Hillsborough Street & E. Rosemary Street

09/01/2020



Lane Group	EBL	EBT	EBR	WBL	WBT	WBR	NBL	NBT	NBR	SBL	SBT	SBR
Control Delay		28.6			29.0		3.4	2.3		11.0	14.3	
Queue Delay		0.0			0.0		0.0	0.0		0.0	0.0	
Total Delay		28.6			29.0		3.4	2.3		11.0	14.3	
LOS		C			C		A	A		B	B	
Approach Delay		28.6			29.0			2.9				14.1
Approach LOS		C			C			A				B
Queue Length 50th (ft)		68			58		10	8		4	102	
Queue Length 95th (ft)		94			77		24	21		17	207	
Internal Link Dist (ft)		1115			447			283				646
Turn Bay Length (ft)							100			100		
Base Capacity (vph)		418			458		603	1318		600	904	
Starvation Cap Reductn		0			0		0	0		0	0	
Spillback Cap Reductn		0			0		0	0		0	0	
Storage Cap Reductn		0			0		0	0		0	0	
Reduced v/c Ratio		0.38			0.38		0.31	0.12		0.04	0.48	

Intersection Summary

Area Type:	Other
Cycle Length:	60
Actuated Cycle Length:	60
Offset:	14 (23%), Referenced to phase 2:NBTL and 6:SBTL, Start of Green
Natural Cycle:	55
Control Type:	Actuated-Coordinated
Maximum v/c Ratio:	0.56
Intersection Signal Delay:	15.0
Intersection LOS:	B
Intersection Capacity Utilization	55.6%
ICU Level of Service	B
Analysis Period (min)	15

Splits and Phases: 7: Hillsborough Street & E. Rosemary Street



Lanes, Volumes, Timings

8: Carolina Square Driveway/Church Street & W. Franklin Street

09/01/2020



Lane Group	EBL	EBT	EBR	WBL	WBT	WBR	NBL	NBT	NBR	SBL	SBT	SBR
Lane Configurations												
Traffic Volume (vph)	45	327	23	10	247	43	2	5	10	20	20	49
Future Volume (vph)	45	327	23	10	247	43	2	5	10	20	20	49
Ideal Flow (vphpl)	1900	1900	1900	1900	1900	1900	1900	1900	1900	1900	1900	1900
Lane Width (ft)	10	10	16	10	10	10	12	12	12	12	12	12
Grade (%)		2%			-2%			-4%				-3%
Storage Length (ft)	150		0	200		0	0		100	0		0
Storage Lanes	1		0	1		0	0		1	0		0
Taper Length (ft)	25			25			25			25		
Lane Util. Factor	1.00	1.00	1.00	1.00	1.00	1.00	1.00	1.00	1.00	1.00	1.00	1.00
Ped Bike Factor	0.95	0.99		0.95	0.98			0.98	0.94		0.94	
Frt		0.990			0.978				0.850		0.926	
Flt Protected	0.950			0.950				0.985			0.989	
Satd. Flow (prot)	1430	1478	0	1431	1450	0	0	1621	1399	0	1431	0
Flt Permitted	0.551			0.510				0.884			0.918	
Satd. Flow (perm)	789	1478	0	730	1450	0	0	1423	1316	0	1317	0
Right Turn on Red			No			No			No			No
Satd. Flow (RTOR)												
Link Speed (mph)		20			20			20			25	
Link Distance (ft)		993			298			285			379	
Travel Time (s)		33.9			10.2			9.7			10.3	
Confl. Peds. (#/hr)	39		57	57		39	57		29	29		57
Peak Hour Factor	0.84	0.84	0.84	0.83	0.83	0.83	0.53	0.53	0.53	0.92	0.92	0.92
Heavy Vehicles (%)	5%	5%	5%	7%	7%	7%	6%	6%	6%	5%	5%	5%
Adj. Flow (vph)	54	389	27	12	298	52	4	9	19	22	22	53
Shared Lane Traffic (%)												
Lane Group Flow (vph)	54	416	0	12	350	0	0	13	19	0	97	0
Turn Type	Perm	NA		Perm	NA		Perm	NA	Perm	Perm	NA	
Protected Phases		2			6			8				4
Permitted Phases	2			6			8		8	4		
Detector Phase	2	2		6	6		8	8	8	4	4	
Switch Phase												
Minimum Initial (s)	10.0	10.0		10.0	10.0		7.0	7.0	7.0	7.0	7.0	
Minimum Split (s)	22.0	22.0		19.0	19.0		29.0	29.0	29.0	27.0	27.0	
Total Split (s)	31.0	31.0		31.0	31.0		29.0	29.0	29.0	29.0	29.0	
Total Split (%)	51.7%	51.7%		51.7%	51.7%		48.3%	48.3%	48.3%	48.3%	48.3%	
Maximum Green (s)	25.4	25.4		25.4	25.4		22.7	22.7	22.7	23.0	23.0	
Yellow Time (s)	3.3	3.3		3.3	3.3		3.1	3.1	3.1	3.4	3.4	
All-Red Time (s)	2.3	2.3		2.3	2.3		3.2	3.2	3.2	2.6	2.6	
Lost Time Adjust (s)	-0.6	-0.6		-0.6	-0.6		-1.3	-1.3	-1.3	-1.0	-1.0	
Total Lost Time (s)	5.0	5.0		5.0	5.0		5.0	5.0	5.0	5.0	5.0	
Lead/Lag												
Lead-Lag Optimize?												
Vehicle Extension (s)	3.0	3.0		3.0	3.0		2.0	2.0	2.0	2.0	2.0	
Recall Mode	C-Max	C-Max		C-Max	C-Max		None	None	None	None	None	
Walk Time (s)	7.0	7.0		7.0	7.0		7.0	7.0	7.0	7.0	7.0	
Flash Dont Walk (s)	9.0	9.0		6.0	6.0		15.0	15.0	15.0	14.0	14.0	
Pedestrian Calls (#/hr)	0	0		0	0		0	0	0	0	0	
Act Effect Green (s)	43.3	43.3		43.3	43.3		10.3	10.3	10.3	10.3	10.3	

Lanes, Volumes, Timings

8: Carolina Square Driveway/Church Street & W. Franklin Street

09/01/2020



Lane Group	EBL	EBT	EBR	WBL	WBT	WBR	NBL	NBT	NBR	SBL	SBT	SBR
Actuated g/C Ratio	0.72	0.72		0.72	0.72			0.17	0.17			0.17
v/c Ratio	0.09	0.39		0.02	0.33			0.05	0.08			0.43
Control Delay	5.0	6.4		2.4	4.3			19.7	20.2			24.6
Queue Delay	0.0	0.0		0.0	0.0			0.0	0.0			0.0
Total Delay	5.0	6.4		2.4	4.3			19.7	20.2			24.6
LOS	A	A		A	A			B	C			C
Approach Delay		6.2			4.2			20.0				24.6
Approach LOS		A			A			C				C
Queue Length 50th (ft)	6	55		3	80			4	6			36
Queue Length 95th (ft)	18	115		m1	45			9	12			56
Internal Link Dist (ft)		913			218			205				299
Turn Bay Length (ft)	150			200					100			
Base Capacity (vph)	569	1067		527	1046			569	526			526
Starvation Cap Reductn	0	0		0	0			0	0			0
Spillback Cap Reductn	0	0		0	0			0	0			0
Storage Cap Reductn	0	0		0	0			0	0			0
Reduced v/c Ratio	0.09	0.39		0.02	0.33			0.02	0.04			0.18

Intersection Summary

Area Type: CBD
 Cycle Length: 60
 Actuated Cycle Length: 60
 Offset: 42 (70%), Referenced to phase 2:EBTL and 6:WBTL, Start of Green
 Natural Cycle: 60
 Control Type: Actuated-Coordinated
 Maximum v/c Ratio: 0.43
 Intersection Signal Delay: 7.8 Intersection LOS: A
 Intersection Capacity Utilization 63.1% ICU Level of Service B
 Analysis Period (min) 15
 m Volume for 95th percentile queue is metered by upstream signal.

Splits and Phases: 8: Carolina Square Driveway/Church Street & W. Franklin Street

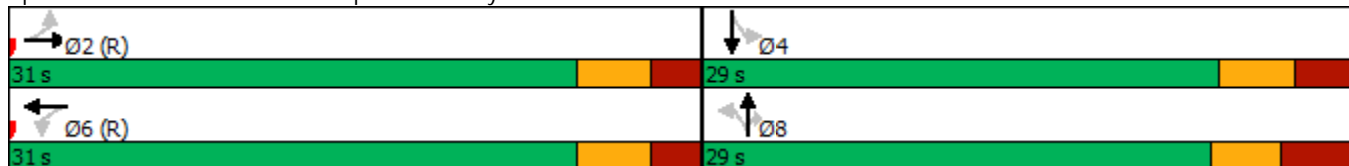

Lanes, Volumes, Timings

9: NC 86 (S. Columbia St)/NC 86 (N. Columbia St) & W. Franklin Street/E. Franklin Street 09/01/2020



Lane Group	EBL	EBT	EBR	WBL	WBT	WBR	NBL	NBT	NBR	SBL	SBT	SBR
Lane Configurations												
Traffic Volume (vph)	61	283	29	65	275	46	30	280	87	36	458	78
Future Volume (vph)	61	283	29	65	275	46	30	280	87	36	458	78
Ideal Flow (vphpl)	1900	1900	1900	1900	1900	1900	1900	1900	1900	1900	1900	1900
Lane Width (ft)	9	12	13	10	10	13	9	10	10	9	9	11
Grade (%)		3%			1%			-2%			3%	
Storage Length (ft)	250		0	125		0	475		0	125		0
Storage Lanes	1		0	1		1	1		0	1		0
Taper Length (ft)	25			25			25			25		
Lane Util. Factor	1.00	0.95	0.95	1.00	1.00	1.00	1.00	0.95	0.95	1.00	0.95	0.95
Ped Bike Factor	0.87	0.99		0.95		0.79	0.97	0.96		0.91	0.99	
Frt		0.986				0.850		0.964			0.978	
Flt Protected	0.950			0.950			0.950			0.950		
Satd. Flow (prot)	1372	2980	0	1410	1484	1397	1342	2576	0	1346	2595	0
Flt Permitted	0.950			0.950			0.950			0.950		
Satd. Flow (perm)	1191	2980	0	1344	1484	1100	1298	2576	0	1221	2595	0
Right Turn on Red			No			No			No			No
Satd. Flow (RTOR)												
Link Speed (mph)		20			20			25			25	
Link Distance (ft)		457			941			981			353	
Travel Time (s)		15.6			32.1			26.8			9.6	
Confl. Peds. (#/hr)	125		49	49		125	29		98	98		29
Peak Hour Factor	0.80	0.80	0.80	0.87	0.87	0.87	0.93	0.93	0.93	0.85	0.85	0.85
Heavy Vehicles (%)	5%	5%	5%	7%	7%	7%	10%	10%	10%	7%	7%	7%
Adj. Flow (vph)	76	354	36	75	316	53	32	301	94	42	539	92
Shared Lane Traffic (%)												
Lane Group Flow (vph)	76	390	0	75	316	53	32	395	0	42	631	0
Turn Type	Prot	NA		Prot	NA	pm+ov	Prot	NA		Prot	NA	
Protected Phases	5	2		1	6	7	3	8		7	4	
Permitted Phases						6						
Detector Phase	5	2		1	6	7	3	8		7	4	
Switch Phase												
Minimum Initial (s)	7.0	10.0		7.0	10.0	7.0	7.0	7.0		7.0	7.0	
Minimum Split (s)	15.0	28.2		15.0	28.2	15.0	15.0	28.0		15.0	28.1	
Total Split (s)	22.0	38.0		22.0	38.0	22.0	22.0	38.0		22.0	38.0	
Total Split (%)	18.3%	31.7%		18.3%	31.7%	18.3%	18.3%	31.7%		18.3%	31.7%	
Maximum Green (s)	16.6	31.8		16.1	31.8	16.1	16.1	32.1		16.1	32.3	
Yellow Time (s)	3.0	3.0		3.0	3.0	3.0	3.0	3.3		3.0	3.1	
All-Red Time (s)	2.4	3.2		2.9	3.2	2.9	2.9	2.6		2.9	2.6	
Lost Time Adjust (s)	-0.4	-1.2		-0.9	-1.2	-2.0	-0.9	-0.9		-0.9	-0.7	
Total Lost Time (s)	5.0	5.0		5.0	5.0	3.9	5.0	5.0		5.0	5.0	
Lead/Lag	Lead	Lag		Lead	Lag	Lead	Lead	Lag		Lead	Lag	
Lead-Lag Optimize?												
Vehicle Extension (s)	1.0	3.0		1.0	3.0	1.0	1.0	2.0		1.0	2.0	
Recall Mode	None	C-Max		None	C-Max	None	None	Ped		None	Ped	
Walk Time (s)		7.0			7.0			7.0			7.0	
Flash Dont Walk (s)		15.0			15.0			15.0			15.0	
Pedestrian Calls (#/hr)		0			0			0			0	
Act Effect Green (s)	10.9	53.0		11.2	53.1	64.5	8.6	31.8		9.2	35.0	

Lanes, Volumes, Timings

9: NC 86 (S. Columbia St)/NC 86 (N. Columbia St) & W. Franklin Street/E. Franklin Street 09/01/2020



Lane Group	EBL	EBT	EBR	WBL	WBT	WBR	NBL	NBT	NBR	SBL	SBT	SBR
Actuated g/C Ratio	0.09	0.44		0.09	0.44	0.54	0.07	0.26		0.08	0.29	
v/c Ratio	0.61	0.30		0.57	0.48	0.09	0.33	0.58		0.41	0.84	
Control Delay	75.6	23.7		79.7	21.0	8.5	79.8	20.5		92.4	29.5	
Queue Delay	0.0	0.0		0.0	0.0	0.0	0.0	0.0		0.0	0.1	
Total Delay	75.6	23.7		79.7	21.0	8.5	79.8	20.5		92.4	29.7	
LOS	E	C		E	C	A	E	C		F	C	
Approach Delay		32.2			29.4			24.9			33.6	
Approach LOS		C			C			C			C	
Queue Length 50th (ft)	60	95		61	93	11	16	143		30	244	
Queue Length 95th (ft)	102	140		109	154	19	m47	144		70	76	
Internal Link Dist (ft)		377			861			901			273	
Turn Bay Length (ft)	250			125			475			125		
Base Capacity (vph)	194	1316		199	657	707	190	750		190	780	
Starvation Cap Reductn	0	0		0	0	0	0	0		0	6	
Spillback Cap Reductn	0	0		0	0	0	0	0		0	0	
Storage Cap Reductn	0	0		0	0	0	0	0		0	0	
Reduced v/c Ratio	0.39	0.30		0.38	0.48	0.07	0.17	0.53		0.22	0.82	

Intersection Summary

Area Type: CBD
 Cycle Length: 120
 Actuated Cycle Length: 120
 Offset: 0 (0%), Referenced to phase 2:EBT and 6:WBT, Start of Green
 Natural Cycle: 90
 Control Type: Actuated-Coordinated
 Maximum v/c Ratio: 0.84
 Intersection Signal Delay: 30.5 Intersection LOS: C
 Intersection Capacity Utilization 65.0% ICU Level of Service C
 Analysis Period (min) 15
 m Volume for 95th percentile queue is metered by upstream signal.

Splits and Phases: 9: NC 86 (S. Columbia St)/NC 86 (N. Columbia St) & W. Franklin Street/E. Franklin Street

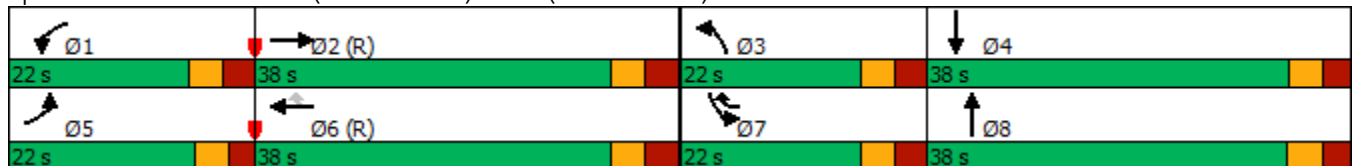

Lanes, Volumes, Timings
 10: E. Franklin Street & Henderson Street

09/01/2020



Lane Group	EBL	EBT	WBT	WBR	SBL	SBR
Lane Configurations		↕↕	↕↔		↔↕	
Traffic Volume (vph)	15	366	384	58	65	17
Future Volume (vph)	15	366	384	58	65	17
Ideal Flow (vphpl)	1900	1900	1900	1900	1900	1900
Lane Width (ft)	10	13	10	10	11	11
Grade (%)		-2%	2%		3%	
Lane Util. Factor	0.95	0.95	0.95	0.95	1.00	1.00
Ped Bike Factor		1.00	0.99		0.95	
Frt			0.980		0.971	
Flt Protected		0.998			0.962	
Satd. Flow (prot)	0	3223	2776	0	1434	0
Flt Permitted		0.934			0.962	
Satd. Flow (perm)	0	3013	2776	0	1387	0
Right Turn on Red				No		No
Satd. Flow (RTOR)						
Link Speed (mph)		20	20		20	
Link Distance (ft)		941	1200		366	
Travel Time (s)		32.1	40.9		12.5	
Confl. Peds. (#/hr)	26			26	44	87
Peak Hour Factor	0.91	0.91	0.90	0.90	0.79	0.79
Heavy Vehicles (%)	5%	5%	5%	5%	4%	4%
Parking (#/hr)						0
Adj. Flow (vph)	16	402	427	64	82	22
Shared Lane Traffic (%)						
Lane Group Flow (vph)	0	418	491	0	104	0
Turn Type	Perm	NA	NA		Prot	
Protected Phases		2	6		4	
Permitted Phases	2					
Detector Phase	2	2	6		4	
Switch Phase						
Minimum Initial (s)	10.0	10.0	10.0		7.0	
Minimum Split (s)	17.0	17.0	22.0		25.0	
Total Split (s)	32.0	32.0	32.0		28.0	
Total Split (%)	53.3%	53.3%	53.3%		46.7%	
Maximum Green (s)	25.8	25.8	25.9		22.9	
Yellow Time (s)	3.0	3.0	3.0		3.0	
All-Red Time (s)	3.2	3.2	3.1		2.1	
Lost Time Adjust (s)		-1.2	-1.1		-0.1	
Total Lost Time (s)		5.0	5.0		5.0	
Lead/Lag						
Lead-Lag Optimize?						
Vehicle Extension (s)	2.0	2.0	2.0		1.0	
Recall Mode	C-Max	C-Max	C-Max		None	
Walk Time (s)			7.0		7.0	
Flash Dont Walk (s)			8.0		12.0	
Pedestrian Calls (#/hr)			0		0	
Act Effct Green (s)		44.6	44.6		8.8	
Actuated g/C Ratio		0.74	0.74		0.15	
v/c Ratio		0.19	0.24		0.50	

Lanes, Volumes, Timings
 10: E. Franklin Street & Henderson Street

09/01/2020



Lane Group	EBL	EBT	WBT	WBR	SBL	SBR
Control Delay		6.8	4.5		28.0	
Queue Delay		0.0	0.0		0.0	
Total Delay		6.8	4.5		28.0	
LOS		A	A		C	
Approach Delay		6.8	4.5		28.0	
Approach LOS		A	A		C	
Queue Length 50th (ft)		95	114		35	
Queue Length 95th (ft)		152	17		57	
Internal Link Dist (ft)		861	1120		286	
Turn Bay Length (ft)						
Base Capacity (vph)		2239	2063		549	
Starvation Cap Reductn		0	0		0	
Spillback Cap Reductn		0	0		0	
Storage Cap Reductn		0	0		0	
Reduced v/c Ratio		0.19	0.24		0.19	

Intersection Summary

Area Type:	CBD
Cycle Length:	60
Actuated Cycle Length:	60
Offset:	53 (88%), Referenced to phase 2:EBTL and 6:WBT, Start of Green
Natural Cycle:	50
Control Type:	Actuated-Coordinated
Maximum v/c Ratio:	0.50
Intersection Signal Delay:	7.8
Intersection LOS:	A
Intersection Capacity Utilization:	47.1%
ICU Level of Service:	A
Analysis Period (min):	15

Splits and Phases: 10: E. Franklin Street & Henderson Street

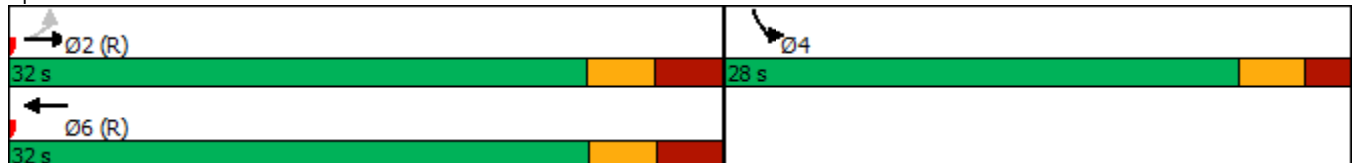

Lanes, Volumes, Timings

11: Raleigh Street/Hillsborough Street & E. Franklin Street

09/01/2020

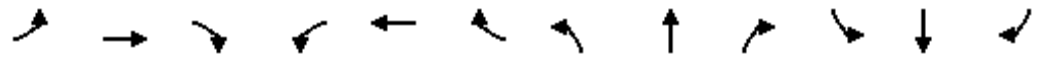

Lane Group	EBL	EBT	EBR	WBL	WBT	WBR	NBL	NBT	NBR	SBL	SBT	SBR
Lane Configurations												
Traffic Volume (vph)	19	312	104	42	409	115	75	192	23	67	337	18
Future Volume (vph)	19	312	104	42	409	115	75	192	23	67	337	18
Ideal Flow (vphpl)	1900	1900	1900	1900	1900	1900	1900	1900	1900	1900	1900	1900
Lane Width (ft)	9	9	10	9	10	11	12	12	12	10	10	10
Grade (%)		1%			-2%			1%			1%	
Storage Length (ft)	75		0	75		0	0		0	100		0
Storage Lanes	1		0	1		0	0		0	1		0
Taper Length (ft)	25			25			25			25		
Lane Util. Factor	1.00	0.95	0.95	1.00	0.95	0.95	1.00	1.00	1.00	1.00	1.00	1.00
Ped Bike Factor	0.99	0.99		0.99	0.99			0.99		0.99	1.00	
Frt		0.962			0.967			0.989			0.992	
Flt Protected	0.950			0.950				0.987		0.950		
Satd. Flow (prot)	1539	2930	0	1578	3142	0	0	1770	0	1627	1695	0
Flt Permitted	0.386			0.437				0.661		0.487		
Satd. Flow (perm)	622	2930	0	718	3142	0	0	1182	0	827	1695	0
Right Turn on Red			No			No			No			No
Satd. Flow (RTOR)												
Link Speed (mph)		20			30			25			25	
Link Distance (ft)		1200			1013			995			363	
Travel Time (s)		40.9			23.0			27.1			9.9	
Confl. Peds. (#/hr)	9		16	16		9	25		11	11		25
Peak Hour Factor	0.86	0.86	0.86	0.92	0.92	0.92	0.83	0.83	0.83	0.96	0.96	0.96
Heavy Vehicles (%)	5%	5%	5%	4%	4%	4%	4%	4%	4%	3%	3%	3%
Adj. Flow (vph)	22	363	121	46	445	125	90	231	28	70	351	19
Shared Lane Traffic (%)												
Lane Group Flow (vph)	22	484	0	46	570	0	0	349	0	70	370	0
Turn Type	Perm	NA		Perm	NA		pm+pt	NA		D.Pm	NA	
Protected Phases		2			6		7	4				8
Permitted Phases	2			6			4			4		
Detector Phase	2	2		6	6		7	4		4		8
Switch Phase												
Minimum Initial (s)	10.0	10.0		10.0	10.0		7.0	7.0		7.0	7.0	
Minimum Split (s)	16.0	16.0		16.0	16.0		14.0	30.0		30.0	29.0	
Total Split (s)	47.0	47.0		47.0	47.0		28.0	73.0		73.0	45.0	
Total Split (%)	39.2%	39.2%		39.2%	39.2%		23.3%	60.8%		60.8%	37.5%	
Maximum Green (s)	41.7	41.7		41.7	41.7		21.8	66.6		66.6	38.6	
Yellow Time (s)	3.0	3.0		3.0	3.0		3.0	3.1		3.1	3.1	
All-Red Time (s)	2.3	2.3		2.3	2.3		3.2	3.3		3.3	3.3	
Lost Time Adjust (s)	-0.3	-0.3		-0.3	-0.3			-1.4		-1.4	-1.4	
Total Lost Time (s)	5.0	5.0		5.0	5.0			5.0		5.0	5.0	
Lead/Lag							Lead				Lag	
Lead-Lag Optimize?												
Vehicle Extension (s)	3.0	3.0		3.0	3.0		3.0	2.0		2.0	2.0	
Recall Mode	C-Max	C-Max		C-Max	C-Max		None	None		None	None	
Walk Time (s)								7.0		7.0	7.0	
Flash Dont Walk (s)								16.0		16.0	15.0	
Pedestrian Calls (#/hr)								0		0	0	
Act Effect Green (s)	59.8	59.8		59.8	59.8			50.2		50.2	50.2	

Lanes, Volumes, Timings

11: Raleigh Street/Hillsborough Street & E. Franklin Street

09/01/2020



Lane Group	EBL	EBT	EBR	WBL	WBT	WBR	NBL	NBT	NBR	SBL	SBT	SBR
Actuated g/C Ratio	0.50	0.50		0.50	0.50			0.42		0.42	0.42	
v/c Ratio	0.07	0.33		0.13	0.36			0.71		0.20	0.52	
Control Delay	14.7	13.9		22.5	21.7			35.5		16.0	22.5	
Queue Delay	0.0	0.0		0.0	0.0			0.0		0.0	2.2	
Total Delay	14.7	13.9		22.5	21.7			35.5		16.0	24.7	
LOS	B	B		C	C			D		B	C	
Approach Delay		14.0			21.7			35.5			23.3	
Approach LOS		B			C			D			C	
Queue Length 50th (ft)	6	72		19	140			217		32	197	
Queue Length 95th (ft)	16	90		54	232			226		52	225	
Internal Link Dist (ft)		1120			933			915			283	
Turn Bay Length (ft)	75			75						100		
Base Capacity (vph)	309	1459		357	1564			669		468	729	
Starvation Cap Reductn	0	0		0	0			0		0	227	
Spillback Cap Reductn	0	0		0	0			0		0	0	
Storage Cap Reductn	0	0		0	0			0		0	0	
Reduced v/c Ratio	0.07	0.33		0.13	0.36			0.52		0.15	0.74	

Intersection Summary

Area Type:	Other
Cycle Length:	120
Actuated Cycle Length:	120
Offset:	61 (51%), Referenced to phase 2:EBTL and 6:WBTL, Start of Green
Natural Cycle:	60
Control Type:	Actuated-Coordinated
Maximum v/c Ratio:	0.71
Intersection Signal Delay:	22.6
Intersection LOS:	C
Intersection Capacity Utilization:	75.9%
ICU Level of Service:	D
Analysis Period (min):	15

Splits and Phases: 11: Raleigh Street/Hillsborough Street & E. Franklin Street

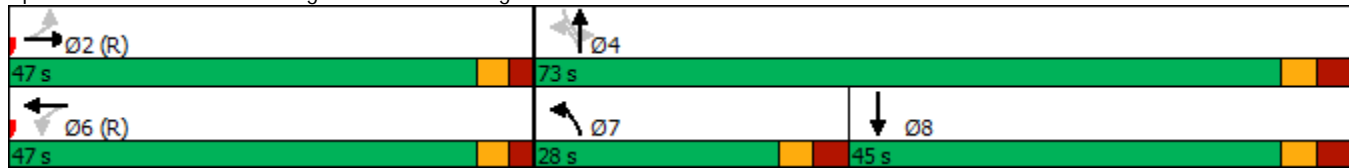

Lanes, Volumes, Timings

14: NC 86 (MLK Jr. Blvd) & Longview Street/Mill Creek Apts Driveway

09/01/2020



Lane Group	EBL	EBT	EBR	WBL	WBT	WBR	NBL	NBT	NBR	SBL	SBT	SBR
Lane Configurations		↕			↕		↕	↕		↕	↕	
Traffic Volume (vph)	77	0	10	6	0	5	2	430	5	0	681	66
Future Volume (vph)	77	0	10	6	0	5	2	430	5	0	681	66
Ideal Flow (vphpl)	1900	1900	1900	1900	1900	1900	1900	1900	1900	1900	1900	1900
Grade (%)		-6%			1%			2%			-4%	
Storage Length (ft)	0		0	0		0	225		0	250		0
Storage Lanes	0		0	0		0	1		0	1		0
Taper Length (ft)	25			25			25			25		
Lane Util. Factor	1.00	1.00	1.00	1.00	1.00	1.00	1.00	0.95	0.95	1.00	0.95	0.95
Ped Bike Factor		1.00			0.99		1.00	1.00			1.00	
Frt		0.985			0.944			0.998			0.987	
Flt Protected		0.958			0.972		0.950					
Satd. Flow (prot)	0	1737	0	0	1701	0	1686	3364	0	1846	3452	0
Flt Permitted		0.742			0.816		0.281					
Satd. Flow (perm)	0	1345	0	0	1418	0	497	3364	0	1846	3452	0
Right Turn on Red			No			No			No			No
Satd. Flow (RTOR)												
Link Speed (mph)		25			20			35			35	
Link Distance (ft)		451			338			2108			784	
Travel Time (s)		12.3			11.5			41.1			15.3	
Confl. Peds. (#/hr)			16	16			4		4	4		4
Peak Hour Factor	0.52	0.52	0.52	0.92	0.92	0.92	0.93	0.93	0.93	0.84	0.84	0.84
Heavy Vehicles (%)	6%	6%	6%	2%	2%	2%	6%	6%	6%	5%	5%	5%
Adj. Flow (vph)	148	0	19	7	0	5	2	462	5	0	811	79
Shared Lane Traffic (%)												
Lane Group Flow (vph)	0	167	0	0	12	0	2	467	0	0	890	0
Turn Type	Perm	NA		Perm	NA		Perm	NA		Perm	NA	
Protected Phases		4			8			2			6	
Permitted Phases	4			8			2			6		
Detector Phase	4	4		8	8		2	2		6	6	
Switch Phase												
Minimum Initial (s)	7.0	7.0		7.0	7.0		12.0	12.0		12.0	12.0	
Minimum Split (s)	31.0	31.0		14.0	14.0		28.0	28.0		28.0	28.0	
Total Split (s)	20.0	20.0		20.0	20.0		60.0	60.0		60.0	60.0	
Total Split (%)	25.0%	25.0%		25.0%	25.0%		75.0%	75.0%		75.0%	75.0%	
Maximum Green (s)	14.0	14.0		13.9	13.9		54.0	54.0		54.5	54.5	
Yellow Time (s)	3.5	3.5		3.0	3.0		4.5	4.5		4.0	4.0	
All-Red Time (s)	2.5	2.5		3.1	3.1		1.5	1.5		1.5	1.5	
Lost Time Adjust (s)		-1.0			-1.0		-1.0	-1.0		-0.5	-0.5	
Total Lost Time (s)		5.0			5.1		5.0	5.0		5.0	5.0	
Lead/Lag												
Lead-Lag Optimize?												
Vehicle Extension (s)	3.0	3.0		3.0	3.0		3.0	3.0		3.0	3.0	
Recall Mode	None	None		None	None		Min	Min		Min	Min	
Walk Time (s)	7.0	7.0					7.0	7.0		7.0	7.0	
Flash Dont Walk (s)	17.0	17.0					9.0	9.0		9.0	9.0	
Pedestrian Calls (#/hr)	0	0					0	0		0	0	
Act Effct Green (s)		11.7			11.6		21.6	21.6			21.6	
Actuated g/C Ratio		0.27			0.27		0.50	0.50			0.50	

Lanes, Volumes, Timings

14: NC 86 (MLK Jr. Blvd) & Longview Street/Mill Creek Apts Driveway

09/01/2020



Lane Group	EBL	EBT	EBR	WBL	WBT	WBR	NBL	NBT	NBR	SBL	SBT	SBR
v/c Ratio		0.46			0.03		0.01	0.28				0.52
Control Delay		17.7			12.1		6.5	7.3				9.1
Queue Delay		0.0			0.0		0.0	0.0				0.0
Total Delay		17.7			12.1		6.5	7.3				9.1
LOS		B			B		A	A				A
Approach Delay		17.7			12.1			7.3				9.1
Approach LOS		B			B			A				A
Queue Length 50th (ft)		30			2		0	31				68
Queue Length 95th (ft)		42			11		3	60				111
Internal Link Dist (ft)		371			258			2028				704
Turn Bay Length (ft)							225					
Base Capacity (vph)		471			493		497	3364				3452
Starvation Cap Reductn		0			0		0	0				0
Spillback Cap Reductn		0			0		0	0				0
Storage Cap Reductn		0			0		0	0				0
Reduced v/c Ratio		0.35			0.02		0.00	0.14				0.26

Intersection Summary

Area Type: Other
 Cycle Length: 80
 Actuated Cycle Length: 43.4
 Natural Cycle: 60
 Control Type: Actuated-Uncoordinated
 Maximum v/c Ratio: 0.52
 Intersection Signal Delay: 9.5
 Intersection Capacity Utilization 42.0%
 Analysis Period (min) 15

Intersection LOS: A
 ICU Level of Service A

Splits and Phases: 14: NC 86 (MLK Jr. Blvd) & Longview Street/Mill Creek Apts Driveway



Lanes, Volumes, Timings
 15: NC 86 (Pittsboro St) & W. Cameron Avenue

09/01/2020



Lane Group	EBT	EBR	WBL	WBT	NBL	NBR	Ø1	Ø4
Lane Configurations	↻		↻↻	↻				
Traffic Volume (vph)	113	159	600	134	0	0		
Future Volume (vph)	113	159	600	134	0	0		
Ideal Flow (vphpl)	1900	1900	1900	1900	1900	1900		
Lane Width (ft)	12	12	11	12	12	12		
Grade (%)	3%			-3%	0%			
Storage Length (ft)		0	75		0	0		
Storage Lanes		0	0		0	0		
Taper Length (ft)			25		25			
Lane Util. Factor	1.00	1.00	0.97	1.00	1.00	1.00		
Ped Bike Factor	0.94		0.90					
Frt	0.921							
Flt Protected			0.950					
Satd. Flow (prot)	1429	0	2837	1592	0	0		
Flt Permitted			0.950					
Satd. Flow (perm)	1429	0	2560	1592	0	0		
Right Turn on Red		No				No		
Satd. Flow (RTOR)								
Link Speed (mph)	25			25	25			
Link Distance (ft)	391			120	794			
Travel Time (s)	30.0			10.7	21.7			
Confl. Peds. (#/hr)		57	57					
Peak Hour Factor	0.81	0.81	0.87	0.87	0.90	0.90		
Heavy Vehicles (%)	2%	2%	9%	9%	2%	2%		
Adj. Flow (vph)	140	196	690	154	0	0		
Shared Lane Traffic (%)								
Lane Group Flow (vph)	336	0	690	154	0	0		
Turn Type	NA		Prot	NA				
Protected Phases	2		1 4	6			1	4
Permitted Phases								
Detector Phase	2		1 4	6				
Switch Phase								
Minimum Initial (s)	10.0			10.0			7.0	7.0
Minimum Split (s)	17.0			15.0			13.0	20.0
Total Split (s)	25.0			40.0			15.0	20.0
Total Split (%)	41.7%			66.7%			25%	33%
Maximum Green (s)	19.9			35.0			9.9	16.0
Yellow Time (s)	3.0			3.3			3.0	3.0
All-Red Time (s)	2.1			1.7			2.1	1.0
Lost Time Adjust (s)	-0.1			0.0				
Total Lost Time (s)	5.0			5.0				
Lead/Lag	Lag						Lead	
Lead-Lag Optimize?								
Vehicle Extension (s)	1.0			1.0			4.0	0.2
Recall Mode	None			C-Max			C-Max	None
Walk Time (s)	7.0							7.0
Flash Dont Walk (s)	4.0							9.0
Pedestrian Calls (#/hr)	0							0
Act Effect Green (s)	20.0		30.0	38.8				

Lanes, Volumes, Timings
 15: NC 86 (Pittsboro St) & W. Cameron Avenue

09/01/2020



Lane Group	EBT	EBR	WBL	WBT	NBL	NBR	Ø1	Ø4
Actuated g/C Ratio	0.33		0.50	0.65				
v/c Ratio	0.71		0.49	0.15				
Control Delay	27.6		14.4	5.9				
Queue Delay	0.0		0.0	0.0				
Total Delay	27.6		14.4	5.9				
LOS	C		B	A				
Approach Delay	27.6			12.9				
Approach LOS	C			B				
Queue Length 50th (ft)	104		190	31				
Queue Length 95th (ft)	162		187	m83				
Internal Link Dist (ft)	311			40	714			
Turn Bay Length (ft)			75					
Base Capacity (vph)	476		1374	1028				
Starvation Cap Reductn	0		0	0				
Spillback Cap Reductn	0		0	0				
Storage Cap Reductn	0		0	0				
Reduced v/c Ratio	0.71		0.50	0.15				

Intersection Summary

Area Type: CBD
 Cycle Length: 60
 Actuated Cycle Length: 60
 Offset: 23 (38%), Referenced to phase 1:WBL and 6:WBT, Start of Green
 Natural Cycle: 60
 Control Type: Actuated-Coordinated
 Maximum v/c Ratio: 0.71
 Intersection Signal Delay: 17.1 Intersection LOS: B
 Intersection Capacity Utilization 47.3% ICU Level of Service A
 Analysis Period (min) 15
 m Volume for 95th percentile queue is metered by upstream signal.

Splits and Phases: 15: NC 86 (Pittsboro St) & W. Cameron Avenue

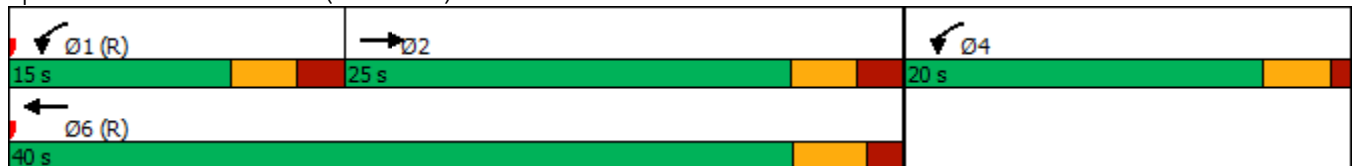

Lanes, Volumes, Timings

16: NC 86 (S. Columbia St) & W. Cameron Avenue/E. Cameron Avenue

09/01/2020



Lane Group	EBL	EBT	EBR	WBL	WBT	WBR	NBL	NBT	NBR	SBL	SBT	SBR
Lane Configurations												
Traffic Volume (vph)	12	91	0	0	95	20	98	359	43	66	0	536
Future Volume (vph)	12	91	0	0	95	20	98	359	43	66	0	536
Ideal Flow (vphp)	1900	1900	1900	1900	1900	1900	1900	1900	1900	1900	1900	1900
Lane Width (ft)	11	12	12	12	12	12	10	10	10	11	11	12
Grade (%)		1%			-1%			1%			2%	
Storage Length (ft)	100		0	0		0	0		0	310		0
Storage Lanes	1		0	0		0	1		0	1		2
Taper Length (ft)	25			25			25			25		
Lane Util. Factor	1.00	1.00	1.00	1.00	1.00	1.00	0.91	0.91	0.95	1.00	1.00	0.88
Ped Bike Factor	0.95				0.99		0.79	0.94		0.74		0.77
Frt					0.977			0.984				0.850
Flt Protected	0.950						0.950	0.999		0.950		
Satd. Flow (prot)	1532	1668	0	0	1565	0	1248	2443	0	1413	0	2302
Flt Permitted	0.522						0.950	0.999		0.950		
Satd. Flow (perm)	803	1668	0	0	1565	0	982	2431	0	1044	0	1776
Right Turn on Red			No			No			No			No
Satd. Flow (RTOR)												
Link Speed (mph)		25			25			25				25
Link Distance (ft)		273			989			826				981
Travel Time (s)		10.7			57.6			22.5				26.8
Confl. Peds. (#/hr)	39		102	102		39	71		107	107		71
Peak Hour Factor	0.79	0.79	0.79	0.83	0.83	0.83	0.86	0.86	0.86	0.89	0.89	0.89
Heavy Vehicles (%)	2%	2%	2%	6%	6%	6%	10%	10%	10%	10%	10%	10%
Adj. Flow (vph)	15	115	0	0	114	24	114	417	50	74	0	602
Shared Lane Traffic (%)							10%					
Lane Group Flow (vph)	15	115	0	0	138	0	103	478	0	74	0	602
Turn Type	Perm	NA			NA		Split	NA		Prot		Prot
Protected Phases		4			8		2	2		1		1
Permitted Phases	4									1		1
Detector Phase	4	4			8		2	2		1		1
Switch Phase												
Minimum Initial (s)	10.0	10.0			10.0		7.0	7.0		7.0		7.0
Minimum Split (s)	24.0	24.0			31.0		18.0	18.0		26.0		26.0
Total Split (s)	34.0	34.0			34.0		22.0	22.0		36.0		36.0
Total Split (%)	28.3%	28.3%			28.3%		18.3%	18.3%		30.0%		30.0%
Maximum Green (s)	27.8	27.8			27.8		16.1	16.1		30.4		30.4
Yellow Time (s)	3.2	3.2			3.2		3.1	3.1		3.0		3.0
All-Red Time (s)	3.0	3.0			3.0		2.8	2.8		2.6		2.6
Lost Time Adjust (s)	-1.2	-1.2			-1.2		-0.9	-0.9		-0.6		-0.6
Total Lost Time (s)	5.0	5.0			5.0		5.0	5.0		5.0		5.0
Lead/Lag							Lag	Lag		Lead		Lead
Lead-Lag Optimize?							Yes	Yes		Yes		Yes
Vehicle Extension (s)	2.0	2.0			2.0		4.0	4.0		4.0		4.0
Recall Mode	None	None			None		C-Max	C-Max		None		None
Walk Time (s)	7.0	7.0			7.0		7.0	7.0		7.0		7.0
Flash Dont Walk (s)	10.0	10.0			17.0		5.0	5.0		13.0		13.0
Pedestrian Calls (#/hr)	0	0			0		0	0		0		0
Act Effect Green (s)	16.4	16.4			16.4		46.9	46.9		41.7		41.7

Lanes, Volumes, Timings

16: NC 86 (S. Columbia St) & W. Cameron Avenue/E. Cameron Avenue

09/01/2020

Lane Group	Ø9
Lane Configurations	
Traffic Volume (vph)	
Future Volume (vph)	
Ideal Flow (vphpl)	
Lane Width (ft)	
Grade (%)	
Storage Length (ft)	
Storage Lanes	
Taper Length (ft)	
Lane Util. Factor	
Ped Bike Factor	
Frt	
Flt Protected	
Satd. Flow (prot)	
Flt Permitted	
Satd. Flow (perm)	
Right Turn on Red	
Satd. Flow (RTOR)	
Link Speed (mph)	
Link Distance (ft)	
Travel Time (s)	
Confl. Peds. (#/hr)	
Peak Hour Factor	
Heavy Vehicles (%)	
Adj. Flow (vph)	
Shared Lane Traffic (%)	
Lane Group Flow (vph)	
Turn Type	
Protected Phases	9
Permitted Phases	
Detector Phase	
Switch Phase	
Minimum Initial (s)	7.0
Minimum Split (s)	28.0
Total Split (s)	28.0
Total Split (%)	23%
Maximum Green (s)	24.0
Yellow Time (s)	3.0
All-Red Time (s)	1.0
Lost Time Adjust (s)	
Total Lost Time (s)	
Lead/Lag	
Lead-Lag Optimize?	
Vehicle Extension (s)	0.2
Recall Mode	None
Walk Time (s)	7.0
Flash Dont Walk (s)	17.0
Pedestrian Calls (#/hr)	0
Act Effect Green (s)	

Lanes, Volumes, Timings

16: NC 86 (S. Columbia St) & W. Cameron Avenue/E. Cameron Avenue

09/01/2020

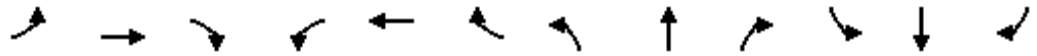

Lane Group	EBL	EBT	EBR	WBL	WBT	WBR	NBL	NBT	NBR	SBL	SBT	SBR
Actuated g/C Ratio	0.14	0.14			0.14		0.39	0.39		0.35		0.35
v/c Ratio	0.14	0.50			0.64		0.21	0.50		0.15		0.75
Control Delay	34.9	41.2			62.3		27.9	31.4		7.2		17.1
Queue Delay	0.0	0.0			0.0		0.0	0.0		0.0		0.0
Total Delay	34.9	41.2			62.3		27.9	31.4		7.2		17.1
LOS	C	D			E		C	C		A		B
Approach Delay		40.5			62.3			30.8			16.0	
Approach LOS		D			E			C			B	
Queue Length 50th (ft)	8	82			103		57	152		5		82
Queue Length 95th (ft)	m11	m111			148		110	219		m16		303
Internal Link Dist (ft)		193			909			746			901	
Turn Bay Length (ft)	100									310		
Base Capacity (vph)	194	403			378		487	953		491		799
Starvation Cap Reductn	0	0			0		0	0		0		0
Spillback Cap Reductn	0	0			0		0	0		0		0
Storage Cap Reductn	0	0			0		0	0		0		0
Reduced v/c Ratio	0.08	0.29			0.37		0.21	0.50		0.15		0.75

Intersection Summary

Area Type: CBD
 Cycle Length: 120
 Actuated Cycle Length: 120
 Offset: 39 (33%), Referenced to phase 2:NBTL, Start of Green
 Natural Cycle: 115
 Control Type: Actuated-Coordinated
 Maximum v/c Ratio: 0.75
 Intersection Signal Delay: 27.9 Intersection LOS: C
 Intersection Capacity Utilization 66.9% ICU Level of Service C
 Analysis Period (min) 15
 m Volume for 95th percentile queue is metered by upstream signal.

Splits and Phases: 16: NC 86 (S. Columbia St) & W. Cameron Avenue/E. Cameron Avenue

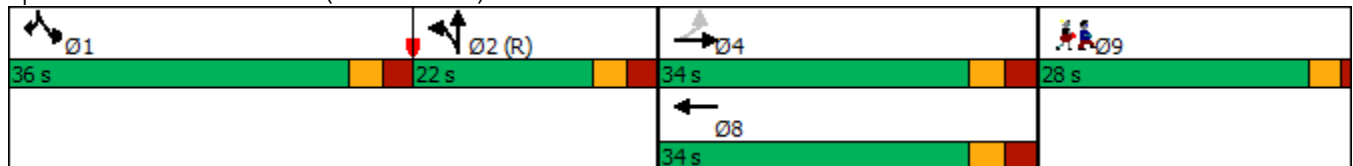

Lanes, Volumes, Timings

16: NC 86 (S. Columbia St) & W. Cameron Avenue/E. Cameron Avenue

09/01/2020

Lane Group	Ø9
Actuated g/C Ratio	
v/c Ratio	
Control Delay	
Queue Delay	
Total Delay	
LOS	
Approach Delay	
Approach LOS	
Queue Length 50th (ft)	
Queue Length 95th (ft)	
Internal Link Dist (ft)	
Turn Bay Length (ft)	
Base Capacity (vph)	
Starvation Cap Reductn	
Spillback Cap Reductn	
Storage Cap Reductn	
Reduced v/c Ratio	
Intersection Summary	

Lanes, Volumes, Timings

17: Raleigh Street & E. Cameron Avenue/Country Club Road

09/01/2020



Lane Group	EBL	EBT	EBR	WBL	WBT	WBR	NBL	NBT	NBR	SBL	SBT	SBR
Lane Configurations		↕		↖	↗		↖	↗		↖	↗	
Traffic Volume (vph)	23	44	32	28	142	226	24	45	17	300	148	48
Future Volume (vph)	23	44	32	28	142	226	24	45	17	300	148	48
Ideal Flow (vphpl)	1900	1900	1900	1900	1900	1900	1900	1900	1900	1900	1900	1900
Grade (%)		-3%			3%			-2%				1%
Storage Length (ft)	0		0	150		0	125		0	75		0
Storage Lanes	0		0	1		0	1		0	1		0
Taper Length (ft)	25			25			25			25		
Lane Util. Factor	1.00	1.00	1.00	1.00	1.00	1.00	1.00	1.00	1.00	1.00	1.00	1.00
Ped Bike Factor		0.98		0.98	0.98		0.91	0.96		0.89	0.95	
Frt		0.956			0.908			0.958			0.963	
Flt Protected		0.989		0.950			0.950			0.950		
Satd. Flow (prot)	0	1493	0	1569	1468	0	1492	1446	0	1569	1509	0
Flt Permitted		0.834		0.574			0.628			0.457		
Satd. Flow (perm)	0	1257	0	934	1468	0	896	1446	0	674	1509	0
Right Turn on Red			No			No			No			No
Satd. Flow (RTOR)												
Link Speed (mph)		25			25			25				25
Link Distance (ft)		598			651			409				995
Travel Time (s)		16.3			17.8			11.2				27.1
Confl. Peds. (#/hr)	3		6	6		3	31		25	25		31
Peak Hour Factor	0.71	0.71	0.71	0.84	0.84	0.84	0.79	0.79	0.79	0.94	0.94	0.94
Heavy Vehicles (%)	8%	8%	8%	2%	2%	2%	10%	10%	10%	3%	3%	3%
Adj. Flow (vph)	32	62	45	33	169	269	30	57	22	319	157	51
Shared Lane Traffic (%)												
Lane Group Flow (vph)	0	139	0	33	438	0	30	79	0	319	208	0
Turn Type	Perm	NA		pm+pt	NA		pm+pt	NA		pm+pt	NA	
Protected Phases		2		1	6		3	8		7	4	
Permitted Phases	2			6			8			4		
Detector Phase	2	2		1	6		3	8		7	4	
Switch Phase												
Minimum Initial (s)	10.0	10.0		7.0	10.0		7.0	7.0		7.0	7.0	
Minimum Split (s)	18.0	18.0		13.0	19.0		13.0	19.0		12.0	16.0	
Total Split (s)	50.0	50.0		20.0	70.0		20.0	35.0		20.0	35.0	
Total Split (%)	40.0%	40.0%		16.0%	56.0%		16.0%	28.0%		16.0%	28.0%	
Maximum Green (s)	43.9	43.9		14.4	64.4		14.7	29.7		15.1	29.9	
Yellow Time (s)	3.3	3.3		3.0	3.1		3.0	3.1		3.0	3.1	
All-Red Time (s)	2.8	2.8		2.6	2.5		2.3	2.2		1.9	2.0	
Lost Time Adjust (s)		-1.1		-0.6	-0.6		-0.3	-0.3		0.1	-0.1	
Total Lost Time (s)		5.0		5.0	5.0		5.0	5.0		5.0	5.0	
Lead/Lag	Lag	Lag		Lead			Lead	Lag		Lead	Lag	
Lead-Lag Optimize?	Yes	Yes		Yes			Yes	Yes		Yes	Yes	
Vehicle Extension (s)	2.0	2.0		2.0	2.0		2.0	2.0		2.0	2.0	
Recall Mode	None	None		None	None		None	None		None	None	
Walk Time (s)	4.0	4.0			4.0			4.0			4.0	
Flash Dont Walk (s)	7.0	7.0			9.0			9.0			6.0	
Pedestrian Calls (#/hr)	0	0			0			0			0	
Act Effect Green (s)		20.5		24.6	24.6		15.5	10.2		25.5	21.7	
Actuated g/C Ratio		0.33		0.40	0.40		0.25	0.17		0.41	0.35	

Lanes, Volumes, Timings

17: Raleigh Street & E. Cameron Avenue/Country Club Road

09/01/2020



Lane Group	EBL	EBT	EBR	WBL	WBT	WBR	NBL	NBT	NBR	SBL	SBT	SBR
v/c Ratio		0.33		0.07	0.75		0.10	0.33		0.65	0.39	
Control Delay		22.0		12.5	25.4		15.1	32.4		22.6	22.4	
Queue Delay		0.0		0.0	0.0		0.0	0.0		0.0	0.0	
Total Delay		22.0		12.5	25.4		15.1	32.4		22.6	22.4	
LOS		C		B	C		B	C		C	C	
Approach Delay		22.0			24.5			27.6			22.5	
Approach LOS		C			C			C			C	
Queue Length 50th (ft)		35		8	141		6	28		79	48	
Queue Length 95th (ft)		79		23	244		24	70		#229	168	
Internal Link Dist (ft)		518			571			329			915	
Turn Bay Length (ft)				150			125			75		
Base Capacity (vph)		923		571	1370		517	799		552	834	
Starvation Cap Reductn		0		0	0		0	0		0	0	
Spillback Cap Reductn		0		0	0		0	0		0	0	
Storage Cap Reductn		0		0	0		0	0		0	0	
Reduced v/c Ratio		0.15		0.06	0.32		0.06	0.10		0.58	0.25	

Intersection Summary

Area Type: CBD
 Cycle Length: 125
 Actuated Cycle Length: 61.5
 Natural Cycle: 65
 Control Type: Actuated-Uncoordinated
 Maximum v/c Ratio: 0.75
 Intersection Signal Delay: 23.7
 Intersection LOS: C
 Intersection Capacity Utilization 61.7%
 ICU Level of Service B
 Analysis Period (min) 15
 # 95th percentile volume exceeds capacity, queue may be longer.
 Queue shown is maximum after two cycles.

Splits and Phases: 17: Raleigh Street & E. Cameron Avenue/Country Club Road



Lanes, Volumes, Timings
1: Church Street & W. Rosemary Street

09/01/2020



Lane Group	EBL	EBT	EBR	WBL	WBT	WBR	NBL	NBT	NBR	SBL	SBT	SBR
Lane Configurations		↕			↕			↕			↕	
Traffic Volume (vph)	6	318	29	39	345	24	23	42	55	14	33	10
Future Volume (vph)	6	318	29	39	345	24	23	42	55	14	33	10
Ideal Flow (vphpl)	1900	1900	1900	1900	1900	1900	1900	1900	1900	1900	1900	1900
Lane Width (ft)	12	14	12	12	14	12	12	12	12	12	12	12
Grade (%)		1%			-1%			0%			0%	
Lane Util. Factor	1.00	1.00	1.00	1.00	1.00	1.00	1.00	1.00	1.00	1.00	1.00	1.00
Ped Bike Factor		0.99			0.99			0.92			0.95	
Frt		0.989			0.992			0.938			0.976	
Flt Protected		0.999			0.995			0.991			0.988	
Satd. Flow (prot)	0	1709	0	0	1747	0	0	1481	0	0	1562	0
Flt Permitted		0.994			0.942			0.920			0.919	
Satd. Flow (perm)	0	1700	0	0	1648	0	0	1335	0	0	1428	0
Right Turn on Red			No			No			No			No
Satd. Flow (RTOR)												
Link Speed (mph)		20			20			25			25	
Link Distance (ft)		964			757			379			430	
Travel Time (s)		32.9			25.8			10.3			11.7	
Confl. Peds. (#/hr)	22		24	24		22	75		39	39		75
Peak Hour Factor	0.88	0.88	0.88	0.93	0.93	0.93	0.92	0.92	0.92	0.64	0.64	0.64
Heavy Vehicles (%)	4%	4%	4%	3%	3%	3%	2%	2%	2%	2%	2%	2%
Adj. Flow (vph)	7	361	33	42	371	26	25	46	60	22	52	16
Shared Lane Traffic (%)												
Lane Group Flow (vph)	0	401	0	0	439	0	0	131	0	0	90	0
Turn Type	Perm	NA		Perm	NA		Perm	NA		Perm	NA	
Protected Phases		2			6			8			4	
Permitted Phases	2			6			8			4		
Detector Phase	2	2		6	6		8	8		4	4	
Switch Phase												
Minimum Initial (s)	10.0	10.0		10.0	10.0		7.0	7.0		7.0	7.0	
Minimum Split (s)	19.0	19.0		20.0	20.0		19.0	19.0		19.0	19.0	
Total Split (s)	43.0	43.0		43.0	43.0		22.0	22.0		22.0	22.0	
Total Split (%)	66.2%	66.2%		66.2%	66.2%		33.8%	33.8%		33.8%	33.8%	
Maximum Green (s)	38.5	38.5		38.4	38.4		17.1	17.1		17.1	17.1	
Yellow Time (s)	3.1	3.1		3.1	3.1		3.2	3.2		3.2	3.2	
All-Red Time (s)	1.4	1.4		1.5	1.5		1.7	1.7		1.7	1.7	
Lost Time Adjust (s)		0.5			0.4			0.1			0.1	
Total Lost Time (s)		5.0			5.0			5.0			5.0	
Lead/Lag												
Lead-Lag Optimize?												
Vehicle Extension (s)	3.0	3.0		3.0	3.0		3.0	3.0		3.0	3.0	
Recall Mode	C-Max	C-Max		C-Max	C-Max		None	None		None	None	
Walk Time (s)	4.0	4.0		4.0	4.0		4.0	4.0		4.0	4.0	
Flash Dont Walk (s)	5.0	5.0		6.0	6.0		10.0	10.0		10.0	10.0	
Pedestrian Calls (#/hr)	0	0		0	0		0	0		0	0	
Act Effct Green (s)		46.9			46.9			11.5			11.5	
Actuated g/C Ratio		0.72			0.72			0.18			0.18	
v/c Ratio		0.33			0.37			0.56			0.36	
Control Delay		6.0			2.6			31.6			26.2	

Lanes, Volumes, Timings
 1: Church Street & W. Rosemary Street

09/01/2020



Lane Group	EBL	EBT	EBR	WBL	WBT	WBR	NBL	NBT	NBR	SBL	SBT	SBR
Queue Delay		0.0			0.0			0.0			0.0	
Total Delay		6.0			2.6			31.6			26.2	
LOS		A			A			C			C	
Approach Delay		6.0			2.6			31.6			26.2	
Approach LOS		A			A			C			C	
Queue Length 50th (ft)		56			23			47			32	
Queue Length 95th (ft)		120			44			66			43	
Internal Link Dist (ft)		884			677			299			350	
Turn Bay Length (ft)												
Base Capacity (vph)		1226			1189			349			373	
Starvation Cap Reductn		0			0			0			0	
Spillback Cap Reductn		0			0			0			0	
Storage Cap Reductn		0			0			0			0	
Reduced v/c Ratio		0.33			0.37			0.38			0.24	

Intersection Summary

Area Type:	CBD
Cycle Length:	65
Actuated Cycle Length:	65
Offset:	23 (35%), Referenced to phase 2:EBTL and 6:WBTL, Start of Green
Natural Cycle:	40
Control Type:	Actuated-Coordinated
Maximum v/c Ratio:	0.56
Intersection Signal Delay:	9.5
Intersection LOS:	A
Intersection Capacity Utilization	66.6%
ICU Level of Service	C
Analysis Period (min)	15

Splits and Phases: 1: Church Street & W. Rosemary Street

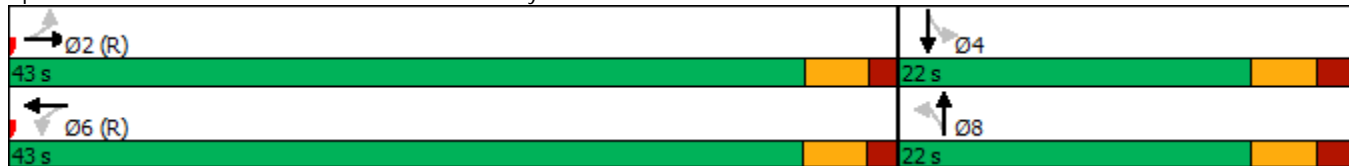

Lanes, Volumes, Timings

2: NC 86 (N. Columbia St) & W. Rosemary Street/E. Rosemary Street

09/01/2020



Lane Group	EBL	EBT	EBR	WBL	WBT	WBR	NBL	NBT	NBR	SBL	SBT	SBR
Lane Configurations												
Traffic Volume (vph)	155	195	48	40	203	54	44	315	99	76	356	178
Future Volume (vph)	155	195	48	40	203	54	44	315	99	76	356	178
Ideal Flow (vphpl)	1900	1900	1900	1900	1900	1900	1900	1900	1900	1900	1900	1900
Lane Width (ft)	9	12	13	12	12	12	9	10	12	12	9	11
Grade (%)		1%			1%			-2%			8%	
Storage Length (ft)	100		0	150		0	75		0	150		400
Storage Lanes	1		0	1		0	1		0	1		1
Taper Length (ft)	25			25			25			25		
Lane Util. Factor	1.00	1.00	1.00	1.00	1.00	1.00	1.00	0.95	0.95	1.00	0.95	1.00
Ped Bike Factor	0.97	0.99		0.96	0.98		0.85	0.88		0.78		0.66
Frt		0.970			0.968			0.964				0.850
Flt Protected	0.950			0.950			0.950			0.950		
Satd. Flow (prot)	1426	1594	0	1585	1584	0	1355	2382	0	1485	2673	1285
Flt Permitted	0.281			0.589			0.462			0.425		
Satd. Flow (perm)	408	1594	0	940	1584	0	563	2382	0	518	2673	850
Right Turn on Red			No			No			No			No
Satd. Flow (RTOR)												
Link Speed (mph)		20			20			25			25	
Link Distance (ft)		757			339			353			476	
Travel Time (s)		25.8			11.6			9.6			13.0	
Confl. Peds. (#/hr)	53		41	41		53	80		129	129		80
Peak Hour Factor	0.88	0.88	0.88	0.85	0.85	0.85	0.98	0.98	0.98	0.86	0.86	0.86
Heavy Vehicles (%)	2%	2%	2%	2%	2%	2%	9%	9%	9%	5%	5%	5%
Adj. Flow (vph)	176	222	55	47	239	64	45	321	101	88	414	207
Shared Lane Traffic (%)												
Lane Group Flow (vph)	176	277	0	47	303	0	45	422	0	88	414	207
Turn Type	pm+pt	NA		Perm	NA		pm+pt	NA		pm+pt	NA	pm+ov
Protected Phases	7	4			8		5	2		1	6	7
Permitted Phases	4			8			2			6		6
Detector Phase	7	4		8	8		5	2		1	6	7
Switch Phase												
Minimum Initial (s)	7.0	7.0		7.0	7.0		7.0	10.0		7.0	10.0	7.0
Minimum Split (s)	13.0	31.0		32.0	32.0		13.0	23.0		13.0	22.0	13.0
Total Split (s)	43.0	63.0		20.0	20.0		15.0	52.0		15.0	52.0	43.0
Total Split (%)	33.1%	48.5%		15.4%	15.4%		11.5%	40.0%		11.5%	40.0%	33.1%
Maximum Green (s)	37.2	57.0		14.0	14.0		9.2	46.2		9.9	46.2	37.2
Yellow Time (s)	3.0	3.2		3.2	3.2		3.0	3.3		3.0	3.3	3.0
All-Red Time (s)	2.8	2.8		2.8	2.8		2.8	2.5		2.1	2.5	2.8
Lost Time Adjust (s)	-0.8	-1.0		-1.0	-1.0		0.0	-0.8		-0.1	-0.8	-0.8
Total Lost Time (s)	5.0	5.0		5.0	5.0		5.8	5.0		5.0	5.0	5.0
Lead/Lag	Lead			Lag	Lag		Lead	Lag		Lead	Lag	Lead
Lead-Lag Optimize?												
Vehicle Extension (s)	1.0	1.0		1.0	1.0		1.0	3.0		1.0	3.0	1.0
Recall Mode	None	None		None	None		None	C-Max		None	C-Max	None
Walk Time (s)		7.0		7.0	7.0			7.0			7.0	
Flash Dont Walk (s)		18.0		19.0	19.0			10.0			9.0	
Pedestrian Calls (#/hr)		0		0	0			0			0	
Act Effect Green (s)	58.0	58.0		33.4	33.4		55.2	48.8		58.3	51.5	71.1

Lanes, Volumes, Timings

2: NC 86 (N. Columbia St) & W. Rosemary Street/E. Rosemary Street

09/01/2020



Lane Group	EBL	EBT	EBR	WBL	WBT	WBR	NBL	NBT	NBR	SBL	SBT	SBR
Actuated g/C Ratio	0.45	0.45		0.26	0.26		0.42	0.38		0.45	0.40	0.55
v/c Ratio	0.53	0.39		0.20	0.75		0.16	0.47		0.30	0.39	0.39
Control Delay	29.6	27.3		41.1	54.5		16.4	19.7		21.9	30.3	17.4
Queue Delay	0.0	0.0		0.0	0.0		0.0	0.6		0.0	0.0	0.0
Total Delay	29.6	27.3		41.1	54.5		16.4	20.3		21.9	30.3	17.4
LOS	C	C		D	D		B	C		C	C	B
Approach Delay		28.2			52.7			19.9			25.5	
Approach LOS		C			D			B			C	
Queue Length 50th (ft)	93	179		27	219		9	47		40	134	86
Queue Length 95th (ft)	123	224		67	#397		m28	112		69	174	111
Internal Link Dist (ft)		677			259			273			396	
Turn Bay Length (ft)	100			150			75			150		400
Base Capacity (vph)	479	711		241	406		303	893		311	1058	712
Starvation Cap Reductn	0	0		0	0		0	189		0	0	0
Spillback Cap Reductn	0	0		0	0		0	0		0	0	0
Storage Cap Reductn	0	0		0	0		0	0		0	0	0
Reduced v/c Ratio	0.37	0.39		0.20	0.75		0.15	0.60		0.28	0.39	0.29

Intersection Summary

Area Type: CBD
 Cycle Length: 130
 Actuated Cycle Length: 130
 Offset: 55 (42%), Referenced to phase 2:NBTL and 6:SBTL, Start of Green
 Natural Cycle: 85
 Control Type: Actuated-Coordinated
 Maximum v/c Ratio: 0.75
 Intersection Signal Delay: 29.6 Intersection LOS: C
 Intersection Capacity Utilization 67.6% ICU Level of Service C
 Analysis Period (min) 15
 # 95th percentile volume exceeds capacity, queue may be longer.
 Queue shown is maximum after two cycles.
 m Volume for 95th percentile queue is metered by upstream signal.

Splits and Phases: 2: NC 86 (N. Columbia St) & W. Rosemary Street/E. Rosemary Street

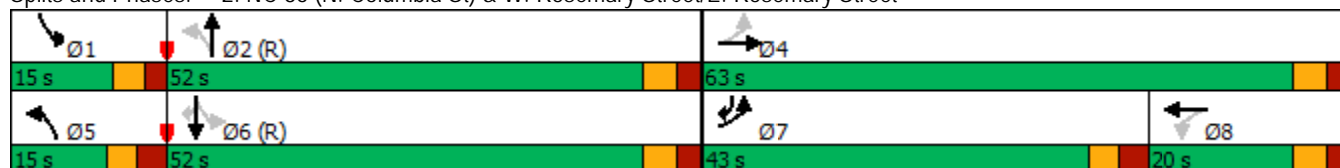

Lanes, Volumes, Timings

6: Henderson Street & E. Rosemary Street

09/01/2020



Lane Group	EBL	EBT	EBR	WBL	WBT	WBR	NBL	NBT	NBR	SBL	SBT	SBR
Lane Configurations												
Traffic Volume (vph)	15	201	140	15	211	31	62	30	11	9	30	13
Future Volume (vph)	15	201	140	15	211	31	62	30	11	9	30	13
Ideal Flow (vphpl)	1900	1900	1900	1900	1900	1900	1900	1900	1900	1900	1900	1900
Grade (%)		0%			0%			0%				3%
Storage Length (ft)	85		0	0		0	0		0	0		0
Storage Lanes	1		0	0		0	0		0	0		0
Taper Length (ft)	25			25			25			25		
Lane Util. Factor	1.00	1.00	1.00	1.00	1.00	1.00	1.00	1.00	1.00	1.00	1.00	1.00
Ped Bike Factor	0.96	0.97			0.99			0.84			0.92	
Frt		0.938			0.984			0.986			0.967	
Flt Protected	0.950				0.997			0.971			0.991	
Satd. Flow (prot)	1593	1524	0	0	1629	0	0	1582	0	0	1474	0
Flt Permitted	0.635				0.976			0.780			0.932	
Satd. Flow (perm)	1025	1524	0	0	1591	0	0	1084	0	0	1364	0
Right Turn on Red			No			No			No			No
Satd. Flow (RTOR)												
Link Speed (mph)		20			20			20			20	
Link Distance (ft)		156			1195			366			450	
Travel Time (s)		5.3			40.7			12.5			15.3	
Confl. Peds. (#/hr)	21		19	19		21	106		47	47		106
Peak Hour Factor	0.96	0.96	0.96	0.95	0.95	0.95	0.68	0.68	0.68	0.85	0.85	0.85
Adj. Flow (vph)	16	209	146	16	222	33	91	44	16	11	35	15
Shared Lane Traffic (%)												
Lane Group Flow (vph)	16	355	0	0	271	0	0	151	0	0	61	0
Turn Type	Perm	NA		Perm	NA		Perm	NA		Perm	NA	
Protected Phases		2			2			4			4	
Permitted Phases	2			2			4			4		
Detector Phase	2	2		2	2		4	4		4	4	
Switch Phase												
Minimum Initial (s)	11.0	11.0		11.0	11.0		8.0	8.0		8.0	8.0	
Minimum Split (s)	15.9	15.9		15.9	15.9		17.8	17.8		17.8	17.8	
Total Split (s)	38.0	38.0		38.0	38.0		27.0	27.0		27.0	27.0	
Total Split (%)	58.5%	58.5%		58.5%	58.5%		41.5%	41.5%		41.5%	41.5%	
Maximum Green (s)	33.1	33.1		33.1	33.1		22.2	22.2		22.2	22.2	
Yellow Time (s)	3.3	3.3		3.3	3.3		3.3	3.3		3.3	3.3	
All-Red Time (s)	1.6	1.6		1.6	1.6		1.5	1.5		1.5	1.5	
Lost Time Adjust (s)	0.1	0.1			0.1			0.2			0.2	
Total Lost Time (s)	5.0	5.0			5.0			5.0			5.0	
Lead/Lag												
Lead-Lag Optimize?												
Vehicle Extension (s)	2.0	2.0		2.0	2.0		2.0	2.0		2.0	2.0	
Recall Mode	C-Max	C-Max		C-Max	C-Max		None	None		None	None	
Walk Time (s)	4.0	4.0		4.0	4.0		4.0	4.0		4.0	4.0	
Flash Dont Walk (s)	7.0	7.0		7.0	7.0		9.0	9.0		9.0	9.0	
Pedestrian Calls (#/hr)	0	0		0	0		0	0		0	0	
Act Effct Green (s)	45.2	45.2			45.2			13.3			13.3	
Actuated g/C Ratio	0.70	0.70			0.70			0.20			0.20	
v/c Ratio	0.02	0.33			0.24			0.68			0.22	

Lanes, Volumes, Timings
 6: Henderson Street & E. Rosemary Street

09/01/2020



Lane Group	EBL	EBT	EBR	WBL	WBT	WBR	NBL	NBT	NBR	SBL	SBT	SBR
Control Delay	5.6	5.6			6.6			36.1			21.4	
Queue Delay	0.0	0.0			0.0			0.0			0.0	
Total Delay	5.6	5.6			6.6			36.1			21.4	
LOS	A	A			A			D			C	
Approach Delay		5.6			6.6			36.1			21.4	
Approach LOS		A			A			D			C	
Queue Length 50th (ft)	2	44			66			68			20	
Queue Length 95th (ft)	m7	100			115			68			40	
Internal Link Dist (ft)		76			1115			286			370	
Turn Bay Length (ft)	85											
Base Capacity (vph)	713	1060			1107			366			461	
Starvation Cap Reductn	0	0			0			0			0	
Spillback Cap Reductn	0	0			0			0			0	
Storage Cap Reductn	0	0			0			0			0	
Reduced v/c Ratio	0.02	0.33			0.24			0.41			0.13	

Intersection Summary

Area Type: CBD
 Cycle Length: 65
 Actuated Cycle Length: 65
 Offset: 63 (97%), Referenced to phase 2:EBWB, Start of Green
 Natural Cycle: 40
 Control Type: Actuated-Coordinated
 Maximum v/c Ratio: 0.68
 Intersection Signal Delay: 12.4
 Intersection LOS: B
 Intersection Capacity Utilization 50.3%
 ICU Level of Service A
 Analysis Period (min) 15
 m Volume for 95th percentile queue is metered by upstream signal.

Splits and Phases: 6: Henderson Street & E. Rosemary Street



Lanes, Volumes, Timings
7: Hillsborough Street & E. Rosemary Street

09/01/2020



Lane Group	EBL	EBT	EBR	WBL	WBT	WBR	NBL	NBT	NBR	SBL	SBT	SBR
Lane Configurations		↕			↕		↗	↘		↗	↘	
Traffic Volume (vph)	23	90	96	3	51	9	169	179	9	16	218	25
Future Volume (vph)	23	90	96	3	51	9	169	179	9	16	218	25
Ideal Flow (vphpl)	1900	1900	1900	1900	1900	1900	1900	1900	1900	1900	1900	1900
Storage Length (ft)	0		0	0		0	100		0	100		0
Storage Lanes	0		0	0		0	1		0	1		0
Taper Length (ft)	25			25			25			25		
Lane Util. Factor	1.00	1.00	1.00	1.00	1.00	1.00	1.00	1.00	1.00	1.00	1.00	1.00
Ped Bike Factor		0.95			0.98		0.93	1.00		0.99	0.98	
Frt		0.938			0.980			0.993			0.985	
Flt Protected		0.994			0.998		0.950			0.950		
Satd. Flow (prot)	0	1662	0	0	1791	0	1770	1847	0	1719	1750	0
Flt Permitted		0.959			0.981		0.487			0.625		
Satd. Flow (perm)	0	1588	0	0	1757	0	843	1847	0	1117	1750	0
Right Turn on Red			No			No			No			No
Satd. Flow (RTOR)												
Link Speed (mph)		20			20			25			25	
Link Distance (ft)		1195			527			363			726	
Travel Time (s)		40.7			18.0			9.9			19.8	
Confl. Peds. (#/hr)	35		35	35		35	50		5	5		50
Peak Hour Factor	0.93	0.93	0.93	0.78	0.78	0.78	0.88	0.88	0.88	0.91	0.91	0.91
Heavy Vehicles (%)	2%	2%	2%	2%	2%	2%	2%	2%	2%	5%	5%	5%
Adj. Flow (vph)	25	97	103	4	65	12	192	203	10	18	240	27
Shared Lane Traffic (%)												
Lane Group Flow (vph)	0	225	0	0	81	0	192	213	0	18	267	0
Turn Type	Perm	NA		Perm	NA		pm+pt	NA		Perm	NA	
Protected Phases		4			8		5	2			6	
Permitted Phases	4			8			2			6		
Detector Phase	4	4		8	8		5	2		6	6	
Switch Phase												
Minimum Initial (s)	7.0	7.0		7.0	7.0		7.0	10.0		10.0	10.0	
Minimum Split (s)	20.0	20.0		17.0	17.0		12.0	15.0		15.0	15.0	
Total Split (s)	24.0	24.0		24.0	24.0		13.0	41.0		28.0	28.0	
Total Split (%)	36.9%	36.9%		36.9%	36.9%		20.0%	63.1%		43.1%	43.1%	
Maximum Green (s)	19.1	19.1		19.0	19.0		8.2	36.2		23.2	23.2	
Yellow Time (s)	3.0	3.0		3.3	3.3		3.0	3.3		3.1	3.1	
All-Red Time (s)	1.9	1.9		1.7	1.7		1.8	1.5		1.7	1.7	
Lost Time Adjust (s)		0.1			0.0		0.2	0.2		0.2	0.2	
Total Lost Time (s)		5.0			5.0		5.0	5.0		5.0	5.0	
Lead/Lag							Lead			Lag	Lag	
Lead-Lag Optimize?												
Vehicle Extension (s)	2.0	2.0		2.0	2.0		2.0	2.0		2.0	2.0	
Recall Mode	None	None		None	None		None	C-Max		C-Max	C-Max	
Walk Time (s)	4.0	4.0		4.0	4.0			4.0		4.0	4.0	
Flash Dont Walk (s)	11.0	11.0		8.0	8.0			6.0		6.0	6.0	
Pedestrian Calls (#/hr)	0	0		0	0			0		0	0	
Act Effct Green (s)		13.3			13.3		41.7	41.7		29.2	29.2	
Actuated g/C Ratio		0.20			0.20		0.64	0.64		0.45	0.45	
v/c Ratio		0.69			0.23		0.30	0.18		0.04	0.34	

Lanes, Volumes, Timings
7: Hillsborough Street & E. Rosemary Street

09/01/2020



Lane Group	EBL	EBT	EBR	WBL	WBT	WBR	NBL	NBT	NBR	SBL	SBT	SBR
Control Delay		31.4			21.3		6.5	5.7		13.0	14.7	
Queue Delay		0.0			0.0		0.0	0.0		0.0	0.0	
Total Delay		31.4			21.3		6.5	5.7		13.0	14.7	
LOS		C			C		A	A		B	B	
Approach Delay		31.4			21.3			6.1			14.6	
Approach LOS		C			C			A			B	
Queue Length 50th (ft)		76			27		53	59		4	65	
Queue Length 95th (ft)		99			45		70	77		17	138	
Internal Link Dist (ft)		1115			447			283			646	
Turn Bay Length (ft)							100			100		
Base Capacity (vph)		464			513		655	1184		502	787	
Starvation Cap Reductn		0			0		0	0		0	0	
Spillback Cap Reductn		0			0		0	0		0	0	
Storage Cap Reductn		0			0		0	0		0	0	
Reduced v/c Ratio		0.48			0.16		0.29	0.18		0.04	0.34	

Intersection Summary

Area Type:	Other
Cycle Length:	65
Actuated Cycle Length:	65
Offset:	19 (29%), Referenced to phase 2:NBTL and 6:SBTL, Start of Green
Natural Cycle:	50
Control Type:	Actuated-Coordinated
Maximum v/c Ratio:	0.69
Intersection Signal Delay:	15.5
Intersection LOS:	B
Intersection Capacity Utilization:	55.2%
ICU Level of Service:	B
Analysis Period (min):	15

Splits and Phases: 7: Hillsborough Street & E. Rosemary Street

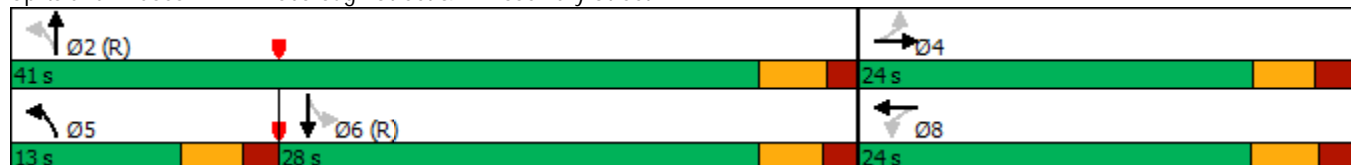

Lanes, Volumes, Timings

8: Carolina Square Driveway/Church Street & W. Franklin Street

09/01/2020



Lane Group	EBL	EBT	EBR	WBL	WBT	WBR	NBL	NBT	NBR	SBL	SBT	SBR
Lane Configurations												
Traffic Volume (vph)	50	357	26	32	328	68	10	10	22	23	23	52
Future Volume (vph)	50	357	26	32	328	68	10	10	22	23	23	52
Ideal Flow (vphpl)	1900	1900	1900	1900	1900	1900	1900	1900	1900	1900	1900	1900
Lane Width (ft)	10	10	16	10	10	10	12	12	12	12	12	12
Grade (%)		2%			-2%			-4%				-3%
Storage Length (ft)	150		0	200		0	0		100	0		0
Storage Lanes	1		0	1		0	0		1	0		0
Taper Length (ft)	25			25			25			25		
Lane Util. Factor	1.00	1.00	1.00	1.00	1.00	1.00	1.00	1.00	1.00	1.00	1.00	1.00
Ped Bike Factor	0.84	0.97		0.78	0.93			0.86	0.87		0.79	
Frt		0.990			0.974				0.850		0.928	
Flt Protected	0.950			0.950				0.976			0.988	
Satd. Flow (prot)	1443	1452	0	1472	1409	0	0	1669	1454	0	1224	0
Flt Permitted	0.485			0.482				0.831			0.920	
Satd. Flow (perm)	620	1452	0	582	1409	0	0	1222	1262	0	1110	0
Right Turn on Red			No			No			No			No
Satd. Flow (RTOR)												
Link Speed (mph)		20			20			20			25	
Link Distance (ft)		993			298			285			379	
Travel Time (s)		33.9			10.2			9.7			10.3	
Confl. Peds. (#/hr)	150		248	248		150	225		77	77		225
Peak Hour Factor	0.87	0.87	0.87	0.91	0.91	0.91	0.81	0.81	0.81	0.71	0.71	0.71
Heavy Vehicles (%)	4%	4%	4%	4%	4%	4%	2%	2%	2%	5%	5%	5%
Adj. Flow (vph)	57	410	30	35	360	75	12	12	27	32	32	73
Shared Lane Traffic (%)												
Lane Group Flow (vph)	57	440	0	35	435	0	0	24	27	0	137	0
Turn Type	Perm	NA		Perm	NA		Perm	NA	Perm	Perm	NA	
Protected Phases		2			6			8				4
Permitted Phases	2			6			8		8	4		
Detector Phase	2	2		6	6		8	8	8	4	4	
Switch Phase												
Minimum Initial (s)	10.0	10.0		10.0	10.0		7.0	7.0	7.0	7.0	7.0	
Minimum Split (s)	22.0	22.0		19.0	19.0		29.0	29.0	29.0	27.0	27.0	
Total Split (s)	36.0	36.0		36.0	36.0		29.0	29.0	29.0	29.0	29.0	
Total Split (%)	55.4%	55.4%		55.4%	55.4%		44.6%	44.6%	44.6%	44.6%	44.6%	
Maximum Green (s)	30.4	30.4		30.4	30.4		22.7	22.7	22.7	23.0	23.0	
Yellow Time (s)	3.3	3.3		3.3	3.3		3.1	3.1	3.1	3.4	3.4	
All-Red Time (s)	2.3	2.3		2.3	2.3		3.2	3.2	3.2	2.6	2.6	
Lost Time Adjust (s)	-0.6	-0.6		-0.6	-0.6			-1.3	-1.3		-1.0	
Total Lost Time (s)	5.0	5.0		5.0	5.0			5.0	5.0		5.0	
Lead/Lag												
Lead-Lag Optimize?												
Vehicle Extension (s)	3.0	3.0		3.0	3.0		2.0	2.0	2.0	2.0	2.0	
Recall Mode	C-Max	C-Max		C-Max	C-Max		None	None	None	None	None	
Walk Time (s)	7.0	7.0		7.0	7.0		7.0	7.0	7.0	7.0	7.0	
Flash Dont Walk (s)	9.0	9.0		6.0	6.0		15.0	15.0	15.0	14.0	14.0	
Pedestrian Calls (#/hr)	0	0		0	0		0	0	0	0	0	
Act Effect Green (s)	45.1	45.1		45.1	45.1			13.6	13.6		13.5	

Lanes, Volumes, Timings

8: Carolina Square Driveway/Church Street & W. Franklin Street

09/01/2020



Lane Group	EBL	EBT	EBR	WBL	WBT	WBR	NBL	NBT	NBR	SBL	SBT	SBR
Actuated g/C Ratio	0.69	0.69		0.69	0.69			0.21	0.21			0.21
v/c Ratio	0.13	0.44		0.09	0.45			0.09	0.10			0.60
Control Delay	7.2	8.7		7.5	8.7			19.1	19.3			32.2
Queue Delay	0.0	0.0		0.0	0.0			0.0	0.0			0.0
Total Delay	7.2	8.7		7.5	8.7			19.1	19.3			32.2
LOS	A	A		A	A			B	B			C
Approach Delay		8.5			8.6			19.2				32.2
Approach LOS		A			A			B				C
Queue Length 50th (ft)	8	76		3	47			8	9			58
Queue Length 95th (ft)	27	171		m26	294			20	22			62
Internal Link Dist (ft)		913			218			205				299
Turn Bay Length (ft)	150			200					100			
Base Capacity (vph)	430	1007		404	977			451	465			409
Starvation Cap Reductn	0	0		0	0			0	0			0
Spillback Cap Reductn	0	0		0	0			0	0			0
Storage Cap Reductn	0	0		0	0			0	0			0
Reduced v/c Ratio	0.13	0.44		0.09	0.45			0.05	0.06			0.33

Intersection Summary

Area Type: CBD
 Cycle Length: 65
 Actuated Cycle Length: 65
 Offset: 2 (3%), Referenced to phase 2:EBTL and 6:WBTL, Start of Green
 Natural Cycle: 60
 Control Type: Actuated-Coordinated
 Maximum v/c Ratio: 0.60
 Intersection Signal Delay: 11.8 Intersection LOS: B
 Intersection Capacity Utilization 70.6% ICU Level of Service C
 Analysis Period (min) 15
 m Volume for 95th percentile queue is metered by upstream signal.

Splits and Phases: 8: Carolina Square Driveway/Church Street & W. Franklin Street

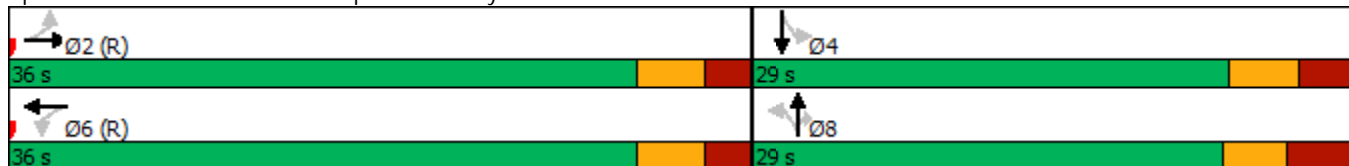

Lanes, Volumes, Timings

9: NC 86 (S. Columbia St)/NC 86 (N. Columbia St) & W. Franklin Street/E. Franklin Street 09/01/2020



Lane Group	EBL	EBT	EBR	WBL	WBT	WBR	NBL	NBT	NBR	SBL	SBT	SBR
Lane Configurations												
Traffic Volume (vph)	101	298	46	82	308	87	61	278	90	50	301	86
Future Volume (vph)	101	298	46	82	308	87	61	278	90	50	301	86
Ideal Flow (vphpl)	1900	1900	1900	1900	1900	1900	1900	1900	1900	1900	1900	1900
Lane Width (ft)	9	12	13	10	10	13	9	10	10	9	9	11
Grade (%)		3%			1%			-2%			3%	
Storage Length (ft)	250		0	125		0	475		0	125		0
Storage Lanes	1		0	1		1	1		0	1		0
Taper Length (ft)	25			25			25			25		
Lane Util. Factor	1.00	0.95	0.95	1.00	1.00	1.00	1.00	0.95	0.95	1.00	0.95	0.95
Ped Bike Factor	0.80	0.96		0.82		0.67	0.82	0.91		0.80	0.92	
Frt		0.980				0.850		0.963			0.967	
Flt Protected	0.950			0.950			0.950			0.950		
Satd. Flow (prot)	1372	2853	0	1437	1512	1423	1342	2446	0	1346	2396	0
Flt Permitted	0.950			0.950			0.950			0.950		
Satd. Flow (perm)	1096	2853	0	1178	1512	947	1096	2446	0	1071	2396	0
Right Turn on Red			No			No			No			No
Satd. Flow (RTOR)												
Link Speed (mph)		20			20			25			25	
Link Distance (ft)		457			941			981			353	
Travel Time (s)		15.6			32.1			26.8			9.6	
Confl. Peds. (#/hr)	251		248	248		251	117		321	321		117
Peak Hour Factor	0.80	0.80	0.80	0.87	0.87	0.87	0.93	0.93	0.93	0.85	0.85	0.85
Heavy Vehicles (%)	5%	5%	5%	5%	5%	5%	10%	10%	10%	7%	7%	7%
Adj. Flow (vph)	126	373	58	94	354	100	66	299	97	59	354	101
Shared Lane Traffic (%)												
Lane Group Flow (vph)	126	431	0	94	354	100	66	396	0	59	455	0
Turn Type	Prot	NA		Prot	NA	pm+ov	Prot	NA		Prot	NA	
Protected Phases	5	2		1	6	7	3	8		7	4	
Permitted Phases						6						
Detector Phase	5	2		1	6	7	3	8		7	4	
Switch Phase												
Minimum Initial (s)	7.0	10.0		7.0	10.0	7.0	7.0	7.0		7.0	7.0	
Minimum Split (s)	15.0	28.2		15.0	28.2	15.0	15.0	28.0		15.0	28.1	
Total Split (s)	25.0	32.0		25.0	32.0	25.0	25.0	48.0		25.0	48.0	
Total Split (%)	19.2%	24.6%		19.2%	24.6%	19.2%	19.2%	36.9%		19.2%	36.9%	
Maximum Green (s)	19.6	25.8		19.1	25.8	19.1	19.1	42.1		19.1	42.3	
Yellow Time (s)	3.0	3.0		3.0	3.0	3.0	3.0	3.3		3.0	3.1	
All-Red Time (s)	2.4	3.2		2.9	3.2	2.9	2.9	2.6		2.9	2.6	
Lost Time Adjust (s)	-0.4	-1.2		-0.9	-1.2	-2.0	-0.9	-0.9		-0.9	-0.7	
Total Lost Time (s)	5.0	5.0		5.0	5.0	3.9	5.0	5.0		5.0	5.0	
Lead/Lag	Lead	Lag		Lead	Lag	Lead	Lead	Lag		Lead	Lag	
Lead-Lag Optimize?												
Vehicle Extension (s)	1.0	3.0		1.0	3.0	1.0	1.0	2.0		1.0	2.0	
Recall Mode	None	C-Max		None	C-Max	None	None	Ped		None	Ped	
Walk Time (s)		7.0			7.0			7.0			7.0	
Flash Dont Walk (s)		15.0			15.0			15.0			15.0	
Pedestrian Calls (#/hr)		0			0			0			0	
Act Effect Green (s)	15.7	55.5		13.0	52.8	65.6	11.2	30.9		10.6	32.8	

Lanes, Volumes, Timings

9: NC 86 (S. Columbia St)/NC 86 (N. Columbia St) & W. Franklin Street/E. Franklin Street 09/01/2020



Lane Group	EBL	EBT	EBR	WBL	WBT	WBR	NBL	NBT	NBR	SBL	SBT	SBR
Actuated g/C Ratio	0.12	0.43		0.10	0.41	0.50	0.09	0.24		0.08	0.25	
v/c Ratio	0.76	0.35		0.66	0.58	0.19	0.57	0.68		0.54	0.75	
Control Delay	76.2	31.0		82.4	38.4	13.5	100.5	29.6		93.2	34.6	
Queue Delay	0.0	0.0		0.0	0.0	0.0	0.0	0.0		0.0	0.0	
Total Delay	76.2	31.0		82.4	38.4	13.5	100.5	29.6		93.2	34.7	
LOS	E	C		F	D	B	F	C		F	C	
Approach Delay		41.2			41.4			39.7			41.4	
Approach LOS		D			D			D			D	
Queue Length 50th (ft)	98	123		73	243	30	57	67		52	87	
Queue Length 95th (ft)	136	210		137	#462	62	106	65		94	84	
Internal Link Dist (ft)		377			861			901			273	
Turn Bay Length (ft)	250			125			475			125		
Base Capacity (vph)	217	1218		221	614	623	206	809		207	792	
Starvation Cap Reductn	0	0		0	0	0	0	0		0	8	
Spillback Cap Reductn	0	0		0	0	0	0	0		0	0	
Storage Cap Reductn	0	0		0	0	0	0	0		0	0	
Reduced v/c Ratio	0.58	0.35		0.43	0.58	0.16	0.32	0.49		0.29	0.58	

Intersection Summary

Area Type: CBD
 Cycle Length: 130
 Actuated Cycle Length: 130
 Offset: 0 (0%), Referenced to phase 2:EBT and 6:WBT, Start of Green
 Natural Cycle: 90
 Control Type: Actuated-Coordinated
 Maximum v/c Ratio: 0.76
 Intersection Signal Delay: 41.0 Intersection LOS: D
 Intersection Capacity Utilization 65.4% ICU Level of Service C
 Analysis Period (min) 15
 # 95th percentile volume exceeds capacity, queue may be longer.
 Queue shown is maximum after two cycles.

Splits and Phases: 9: NC 86 (S. Columbia St)/NC 86 (N. Columbia St) & W. Franklin Street/E. Franklin Street

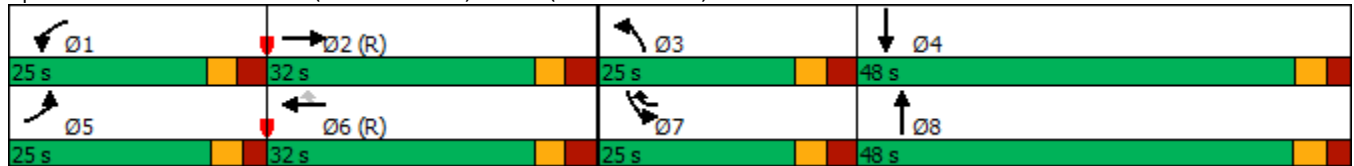

Lanes, Volumes, Timings
10: E. Franklin Street & Henderson Street

09/01/2020

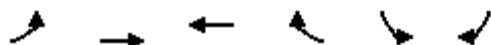

Lane Group	EBL	EBT	WBT	WBR	SBL	SBR
Lane Configurations		↑↑	↑↑		↑↑	
Traffic Volume (vph)	47	377	415	61	106	80
Future Volume (vph)	47	377	415	61	106	80
Ideal Flow (vphpl)	1900	1900	1900	1900	1900	1900
Lane Width (ft)	10	13	10	10	11	11
Grade (%)		-2%	2%		3%	
Lane Util. Factor	0.95	0.95	0.95	0.95	1.00	1.00
Ped Bike Factor		0.99	0.97		0.80	
Frt			0.981		0.942	
Flt Protected		0.995			0.972	
Satd. Flow (prot)	0	3213	2733	0	1259	0
Flt Permitted		0.861			0.972	
Satd. Flow (perm)	0	2744	2733	0	1164	0
Right Turn on Red				No		No
Satd. Flow (RTOR)						
Link Speed (mph)		20	20		20	
Link Distance (ft)		941	1200		366	
Travel Time (s)		32.1	40.9		12.5	
Confl. Peds. (#/hr)	119			119	130	370
Peak Hour Factor	0.95	0.95	0.92	0.92	0.87	0.87
Heavy Vehicles (%)	5%	5%	4%	4%	2%	2%
Parking (#/hr)						0
Adj. Flow (vph)	49	397	451	66	122	92
Shared Lane Traffic (%)						
Lane Group Flow (vph)	0	446	517	0	214	0
Turn Type	Perm	NA	NA		Prot	
Protected Phases		2	6		4	
Permitted Phases	2					
Detector Phase	2	2	6		4	
Switch Phase						
Minimum Initial (s)	10.0	10.0	10.0		7.0	
Minimum Split (s)	17.0	17.0	22.0		25.0	
Total Split (s)	32.0	32.0	32.0		33.0	
Total Split (%)	49.2%	49.2%	49.2%		50.8%	
Maximum Green (s)	25.8	25.8	25.9		27.9	
Yellow Time (s)	3.0	3.0	3.0		3.0	
All-Red Time (s)	3.2	3.2	3.1		2.1	
Lost Time Adjust (s)		-1.2	-1.1		-0.1	
Total Lost Time (s)		5.0	5.0		5.0	
Lead/Lag						
Lead-Lag Optimize?						
Vehicle Extension (s)	2.0	2.0	2.0		1.0	
Recall Mode	C-Max	C-Max	C-Max		None	
Walk Time (s)			7.0		7.0	
Flash Dont Walk (s)			8.0		12.0	
Pedestrian Calls (#/hr)			0		0	
Act Effct Green (s)		40.0	40.0		15.0	
Actuated g/C Ratio		0.62	0.62		0.23	
v/c Ratio		0.26	0.31		0.74	

Lanes, Volumes, Timings
 10: E. Franklin Street & Henderson Street

09/01/2020



Lane Group	EBL	EBT	WBT	WBR	SBL	SBR
Control Delay		6.5	8.3		35.8	
Queue Delay		0.0	0.0		0.0	
Total Delay		6.5	8.3		35.8	
LOS		A	A		D	
Approach Delay		6.5	8.3		35.8	
Approach LOS		A	A		D	
Queue Length 50th (ft)		19	38		92	
Queue Length 95th (ft)		142	155		129	
Internal Link Dist (ft)		861	1120		286	
Turn Bay Length (ft)						
Base Capacity (vph)		1689	1682		542	
Starvation Cap Reductn		0	0		0	
Spillback Cap Reductn		0	0		0	
Storage Cap Reductn		0	0		0	
Reduced v/c Ratio		0.26	0.31		0.39	

Intersection Summary

Area Type:	CBD
Cycle Length:	65
Actuated Cycle Length:	65
Offset:	4 (6%), Referenced to phase 2:EBTL and 6:WBT, Start of Green
Natural Cycle:	50
Control Type:	Actuated-Coordinated
Maximum v/c Ratio:	0.74
Intersection Signal Delay:	12.6
Intersection LOS:	B
Intersection Capacity Utilization:	57.2%
ICU Level of Service:	B
Analysis Period (min):	15

Splits and Phases: 10: E. Franklin Street & Henderson Street

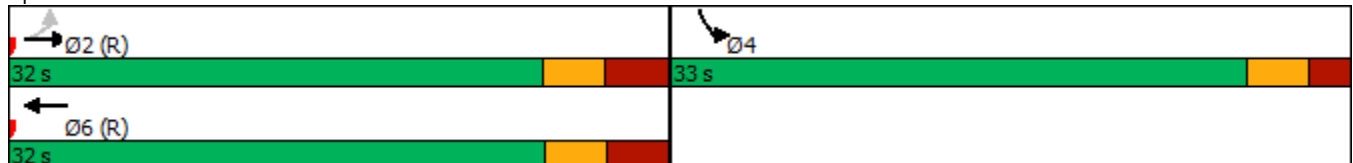

Lanes, Volumes, Timings

11: Raleigh Street/Hillsborough Street & E. Franklin Street

09/01/2020



Lane Group	EBL	EBT	EBR	WBL	WBT	WBR	NBL	NBT	NBR	SBL	SBT	SBR
Lane Configurations												
Traffic Volume (vph)	55	337	152	41	374	148	86	163	23	77	197	23
Future Volume (vph)	55	337	152	41	374	148	86	163	23	77	197	23
Ideal Flow (vphpl)	1900	1900	1900	1900	1900	1900	1900	1900	1900	1900	1900	1900
Lane Width (ft)	9	9	10	9	10	11	12	12	12	10	10	10
Grade (%)		1%			-2%			1%			1%	
Storage Length (ft)	75		0	75		0	0		0	100		0
Storage Lanes	1		0	1		0	0		0	1		0
Taper Length (ft)	25			25			25			25		
Lane Util. Factor	1.00	0.95	0.95	1.00	0.95	0.95	1.00	1.00	1.00	1.00	1.00	1.00
Ped Bike Factor	0.98	0.98		0.99	0.98			0.97		0.97	0.98	
Frt		0.953			0.957			0.989			0.984	
Flt Protected	0.950			0.950				0.984		0.950		
Satd. Flow (prot)	1539	2889	0	1593	3092	0	0	1794	0	1612	1639	0
Flt Permitted	0.406			0.425				0.668		0.498		
Satd. Flow (perm)	642	2889	0	703	3092	0	0	1188	0	819	1639	0
Right Turn on Red			No			No			No			No
Satd. Flow (RTOR)												
Link Speed (mph)		20			30			25			25	
Link Distance (ft)		1200			1013			995			363	
Travel Time (s)		40.9			23.0			27.1			9.9	
Confl. Peds. (#/hr)	50		25	25		50	93		33	33		93
Peak Hour Factor	0.91	0.91	0.91	0.91	0.91	0.91	0.94	0.94	0.94	0.90	0.90	0.90
Heavy Vehicles (%)	5%	5%	5%	3%	3%	3%	2%	2%	2%	4%	4%	4%
Adj. Flow (vph)	60	370	167	45	411	163	91	173	24	86	219	26
Shared Lane Traffic (%)												
Lane Group Flow (vph)	60	537	0	45	574	0	0	288	0	86	245	0
Turn Type	Perm	NA		Perm	NA		pm+pt	NA		D.Pm	NA	
Protected Phases		2			6		7	4				8
Permitted Phases	2			6			4			4		
Detector Phase	2	2		6	6		7	4		4		8
Switch Phase												
Minimum Initial (s)	10.0	10.0		10.0	10.0		7.0	7.0		7.0	7.0	
Minimum Split (s)	16.0	16.0		16.0	16.0		14.0	30.0		30.0	29.0	
Total Split (s)	60.0	60.0		60.0	60.0		31.0	70.0		70.0	39.0	
Total Split (%)	46.2%	46.2%		46.2%	46.2%		23.8%	53.8%		53.8%	30.0%	
Maximum Green (s)	54.7	54.7		54.7	54.7		24.8	63.6		63.6	32.6	
Yellow Time (s)	3.0	3.0		3.0	3.0		3.0	3.1		3.1	3.1	
All-Red Time (s)	2.3	2.3		2.3	2.3		3.2	3.3		3.3	3.3	
Lost Time Adjust (s)	-0.3	-0.3		-0.3	-0.3			-1.4		-1.4	-1.4	
Total Lost Time (s)	5.0	5.0		5.0	5.0			5.0		5.0	5.0	
Lead/Lag							Lead				Lag	
Lead-Lag Optimize?												
Vehicle Extension (s)	3.0	3.0		3.0	3.0		3.0	2.0		2.0	2.0	
Recall Mode	C-Max	C-Max		C-Max	C-Max		None	None		None	None	
Walk Time (s)								7.0		7.0	7.0	
Flash Dont Walk (s)								16.0		16.0	15.0	
Pedestrian Calls (#/hr)								0		0	0	
Act Effect Green (s)	78.3	78.3		78.3	78.3			41.7		41.7	41.7	

Lanes, Volumes, Timings

11: Raleigh Street/Hillsborough Street & E. Franklin Street

09/01/2020



Lane Group	EBL	EBT	EBR	WBL	WBT	WBR	NBL	NBT	NBR	SBL	SBT	SBR
Actuated g/C Ratio	0.60	0.60		0.60	0.60			0.32		0.32	0.32	
v/c Ratio	0.16	0.31		0.11	0.31			0.76		0.33	0.47	
Control Delay	13.8	11.7		15.4	14.8			51.3		31.1	34.5	
Queue Delay	0.0	0.0		0.0	0.0			0.0		0.0	4.4	
Total Delay	13.8	11.7		15.4	14.8			51.3		31.1	38.8	
LOS	B	B		B	B			D		C	D	
Approach Delay		11.9			14.8			51.3			36.8	
Approach LOS		B			B			D			D	
Queue Length 50th (ft)	13	66		15	118			217		50	151	
Queue Length 95th (ft)	51	156		45	199			277		80	194	
Internal Link Dist (ft)		1120			933			915			283	
Turn Bay Length (ft)	75			75						100		
Base Capacity (vph)	386	1740		423	1862			594		409	543	
Starvation Cap Reductn	0	0		0	0			0		0	222	
Spillback Cap Reductn	0	0		0	0			0		0	0	
Storage Cap Reductn	0	0		0	0			0		0	0	
Reduced v/c Ratio	0.16	0.31		0.11	0.31			0.48		0.21	0.76	

Intersection Summary

Area Type:	Other
Cycle Length:	130
Actuated Cycle Length:	130
Offset:	57 (44%), Referenced to phase 2:EBTL and 6:WBTL, Start of Green
Natural Cycle:	60
Control Type:	Actuated-Coordinated
Maximum v/c Ratio:	0.76
Intersection Signal Delay:	23.6
Intersection LOS:	C
Intersection Capacity Utilization:	77.0%
ICU Level of Service:	D
Analysis Period (min):	15

Splits and Phases: 11: Raleigh Street/Hillsborough Street & E. Franklin Street

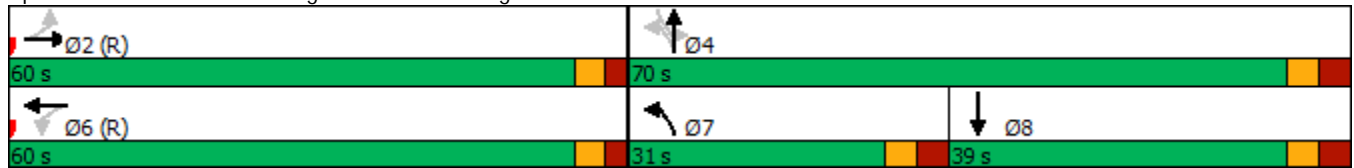

Lanes, Volumes, Timings

14: NC 86 (MLK Jr. Blvd) & Longview Street/Mill Creek Apts Driveway

09/01/2020



Lane Group	EBL	EBT	EBR	WBL	WBT	WBR	NBL	NBT	NBR	SBL	SBT	SBR
Lane Configurations		↕			↕		↕	↕↔		↕	↕↔	
Traffic Volume (vph)	37	0	19	4	0	2	7	485	8	1	530	35
Future Volume (vph)	37	0	19	4	0	2	7	485	8	1	530	35
Ideal Flow (vphpl)	1900	1900	1900	1900	1900	1900	1900	1900	1900	1900	1900	1900
Grade (%)		-6%			1%			2%			-4%	
Storage Length (ft)	0		0	0		0	225		0	250		0
Storage Lanes	0		0	0		0	1		0	1		0
Taper Length (ft)	25			25			25			25		
Lane Util. Factor	1.00	1.00	1.00	1.00	1.00	1.00	1.00	0.95	0.95	1.00	0.95	0.95
Ped Bike Factor		0.99			0.98		0.99	1.00		0.98	1.00	
Frt		0.954			0.955			0.998			0.991	
Flt Protected		0.968			0.968		0.950			0.950		
Satd. Flow (prot)	0	1720	0	0	1706	0	1670	3330	0	1753	3467	0
Flt Permitted		0.794			0.754		0.417			0.445		
Satd. Flow (perm)	0	1410	0	0	1314	0	728	3330	0	807	3467	0
Right Turn on Red			No			No			No			No
Satd. Flow (RTOR)												
Link Speed (mph)		25			20			35			35	
Link Distance (ft)		451			338			2108			784	
Travel Time (s)		12.3			11.5			41.1			15.3	
Confl. Peds. (#/hr)	1		19	19		1	7		15	15		7
Peak Hour Factor	0.76	0.76	0.76	0.50	0.50	0.50	0.89	0.89	0.89	0.91	0.91	0.91
Heavy Vehicles (%)	4%	4%	4%	2%	2%	2%	7%	7%	7%	5%	5%	5%
Adj. Flow (vph)	49	0	25	8	0	4	8	545	9	1	582	38
Shared Lane Traffic (%)												
Lane Group Flow (vph)	0	74	0	0	12	0	8	554	0	1	620	0
Turn Type	Perm	NA		Perm	NA		Perm	NA		Perm	NA	
Protected Phases		4			8			2			6	
Permitted Phases	4			8			2			6		
Detector Phase	4	4		8	8		2	2		6	6	
Switch Phase												
Minimum Initial (s)	7.0	7.0		7.0	7.0		12.0	12.0		12.0	12.0	
Minimum Split (s)	31.0	31.0		14.0	14.0		28.0	28.0		28.0	28.0	
Total Split (s)	20.0	20.0		20.0	20.0		60.0	60.0		60.0	60.0	
Total Split (%)	25.0%	25.0%		25.0%	25.0%		75.0%	75.0%		75.0%	75.0%	
Maximum Green (s)	14.0	14.0		13.9	13.9		54.0	54.0		54.5	54.5	
Yellow Time (s)	3.5	3.5		3.0	3.0		4.5	4.5		4.0	4.0	
All-Red Time (s)	2.5	2.5		3.1	3.1		1.5	1.5		1.5	1.5	
Lost Time Adjust (s)		-1.0			-1.0		-1.0	-1.0		-0.5	-0.5	
Total Lost Time (s)		5.0			5.1		5.0	5.0		5.0	5.0	
Lead/Lag												
Lead-Lag Optimize?												
Vehicle Extension (s)	3.0	3.0		3.0	3.0		3.0	3.0		3.0	3.0	
Recall Mode	None	None		None	None		Min	Min		Min	Min	
Walk Time (s)	7.0	7.0					7.0	7.0		7.0	7.0	
Flash Dont Walk (s)	17.0	17.0					9.0	9.0		9.0	9.0	
Pedestrian Calls (#/hr)	0	0					0	0		0	0	
Act Effct Green (s)		8.6			8.6		24.2	24.2		24.2	24.2	
Actuated g/C Ratio		0.24			0.24		0.69	0.69		0.69	0.69	

Lanes, Volumes, Timings

14: NC 86 (MLK Jr. Blvd) & Longview Street/Mill Creek Apts Driveway

09/01/2020



Lane Group	EBL	EBT	EBR	WBL	WBT	WBR	NBL	NBT	NBR	SBL	SBT	SBR
v/c Ratio		0.21			0.04		0.02	0.24		0.00	0.26	
Control Delay		12.5			10.7		5.6	5.0		5.0	5.1	
Queue Delay		0.0			0.0		0.0	0.0		0.0	0.0	
Total Delay		12.5			10.7		5.6	5.0		5.0	5.1	
LOS		B			B		A	A		A	A	
Approach Delay		12.5			10.7			5.1			5.1	
Approach LOS		B			B			A			A	
Queue Length 50th (ft)		14			2		1	30		0	33	
Queue Length 95th (ft)		27			5		5	56		1	63	
Internal Link Dist (ft)		371			258			2028			704	
Turn Bay Length (ft)							225			250		
Base Capacity (vph)		604			559		728	3330		807	3467	
Starvation Cap Reductn		0			0		0	0		0	0	
Spillback Cap Reductn		0			0		0	0		0	0	
Storage Cap Reductn		0			0		0	0		0	0	
Reduced v/c Ratio		0.12			0.02		0.01	0.17		0.00	0.18	

Intersection Summary

Area Type:	Other
Cycle Length:	80
Actuated Cycle Length:	35.2
Natural Cycle:	60
Control Type:	Actuated-Uncoordinated
Maximum v/c Ratio:	0.26
Intersection Signal Delay:	5.6
Intersection LOS:	A
Intersection Capacity Utilization:	36.6%
ICU Level of Service:	A
Analysis Period (min):	15

Splits and Phases: 14: NC 86 (MLK Jr. Blvd) & Longview Street/Mill Creek Apts Driveway



Lanes, Volumes, Timings
 15: NC 86 (Pittsboro St) & W. Cameron Avenue

09/01/2020



Lane Group	EBT	EBR	WBL	WBT	NBL	NBR	Ø1	Ø4
Lane Configurations	↻		↻↻	↻				
Traffic Volume (vph)	75	152	434	214	0	0		
Future Volume (vph)	75	152	434	214	0	0		
Ideal Flow (vphpl)	1900	1900	1900	1900	1900	1900		
Lane Width (ft)	12	12	11	12	12	12		
Grade (%)	3%			-3%	0%			
Storage Length (ft)		0	75		0	0		
Storage Lanes		0	0		0	0		
Taper Length (ft)			25		25			
Lane Util. Factor	1.00	1.00	0.97	1.00	1.00	1.00		
Ped Bike Factor	0.77		0.65					
Frt	0.910							
Flt Protected			0.950					
Satd. Flow (prot)	1164	0	2837	1592	0	0		
Flt Permitted			0.950					
Satd. Flow (perm)	1164	0	1832	1592	0	0		
Right Turn on Red		No				No		
Satd. Flow (RTOR)								
Link Speed (mph)	25			25	25			
Link Distance (ft)	391			120	794			
Travel Time (s)	30.0			10.7	21.7			
Confl. Peds. (#/hr)		129	129					
Peak Hour Factor	0.71	0.71	0.93	0.93	0.90	0.90		
Heavy Vehicles (%)	2%	2%	9%	9%	2%	2%		
Adj. Flow (vph)	106	214	467	230	0	0		
Shared Lane Traffic (%)								
Lane Group Flow (vph)	320	0	467	230	0	0		
Turn Type	NA		Prot	NA				
Protected Phases	2		1 4	6			1	4
Permitted Phases								
Detector Phase	2		1 4	6				
Switch Phase								
Minimum Initial (s)	10.0			10.0			7.0	7.0
Minimum Split (s)	20.0			20.0			20.0	20.0
Total Split (s)	77.0			110.0			33.0	20.0
Total Split (%)	59.2%			84.6%			25%	15%
Maximum Green (s)	71.9			105.0			27.9	16.0
Yellow Time (s)	3.0			3.3			3.0	3.0
All-Red Time (s)	2.1			1.7			2.1	1.0
Lost Time Adjust (s)	-0.1			0.0				
Total Lost Time (s)	5.0			5.0				
Lead/Lag	Lag						Lead	
Lead-Lag Optimize?								
Vehicle Extension (s)	1.0			1.0			4.0	0.2
Recall Mode	None			C-Max			C-Max	None
Walk Time (s)	7.0							7.0
Flash Dont Walk (s)	4.0							9.0
Pedestrian Calls (#/hr)	0							0
Act Effect Green (s)	72.0		48.0	105.6				

Lanes, Volumes, Timings
 15: NC 86 (Pittsboro St) & W. Cameron Avenue

09/01/2020



Lane Group	EBT	EBR	WBL	WBT	NBL	NBR	Ø1	Ø4
Actuated g/C Ratio	0.55		0.37	0.81				
v/c Ratio	0.50		0.45	0.18				
Control Delay	21.2		26.1	3.1				
Queue Delay	0.0		1.0	0.5				
Total Delay	21.2		27.1	3.6				
LOS	C		C	A				
Approach Delay	21.2			19.4				
Approach LOS	C			B				
Queue Length 50th (ft)	160		155	29				
Queue Length 95th (ft)	171		232	m61				
Internal Link Dist (ft)	311			40	714			
Turn Bay Length (ft)			75					
Base Capacity (vph)	644		1038	1292				
Starvation Cap Reductn	0		323	717				
Spillback Cap Reductn	0		0	0				
Storage Cap Reductn	0		0	0				
Reduced v/c Ratio	0.50		0.65	0.40				

Intersection Summary

Area Type: CBD
 Cycle Length: 130
 Actuated Cycle Length: 130
 Offset: 28 (22%), Referenced to phase 1:WBL and 6:WBT, Start of Green
 Natural Cycle: 60
 Control Type: Actuated-Coordinated
 Maximum v/c Ratio: 0.50
 Intersection Signal Delay: 19.9 Intersection LOS: B
 Intersection Capacity Utilization 41.3% ICU Level of Service A
 Analysis Period (min) 15
 m Volume for 95th percentile queue is metered by upstream signal.

Splits and Phases: 15: NC 86 (Pittsboro St) & W. Cameron Avenue

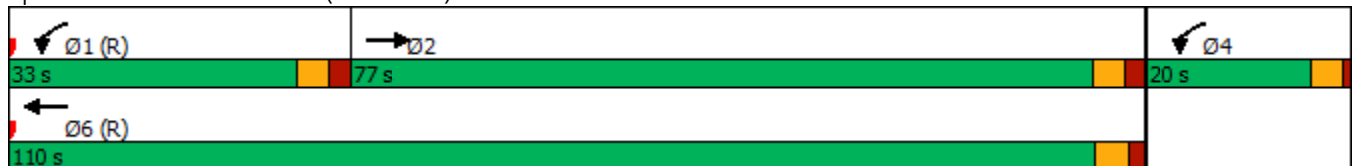

Lanes, Volumes, Timings

16: NC 86 (S. Columbia St) & W. Cameron Avenue/E. Cameron Avenue

09/01/2020



Lane Group	EBL	EBT	EBR	WBL	WBT	WBR	NBL	NBT	NBR	SBL	SBT	SBR
Lane Configurations												
Traffic Volume (vph)	17	51	0	0	90	37	169	362	27	43	0	388
Future Volume (vph)	17	51	0	0	90	37	169	362	27	43	0	388
Ideal Flow (vphpl)	1900	1900	1900	1900	1900	1900	1900	1900	1900	1900	1900	1900
Lane Width (ft)	11	12	12	12	12	12	10	10	10	11	11	12
Grade (%)		1%			-1%			1%			2%	
Storage Length (ft)	100		0	0		0	0		0	310		0
Storage Lanes	1		0	0		0	1		0	1		2
Taper Length (ft)	25			25			25			25		
Lane Util. Factor	1.00	1.00	1.00	1.00	1.00	1.00	0.91	0.91	0.95	1.00	1.00	0.88
Ped Bike Factor	0.77				0.91		0.60	0.93		0.60		0.43
Frt					0.961			0.990				0.850
Flt Protected	0.950						0.950	0.998		0.950		
Satd. Flow (prot)	1488	1620	0	0	1403	0	1259	2485	0	1439	0	2345
Flt Permitted	0.489						0.950	0.998		0.950		
Satd. Flow (perm)	590	1620	0	0	1403	0	757	2443	0	858	0	1014
Right Turn on Red			No			No			No			No
Satd. Flow (RTOR)												
Link Speed (mph)		25			25			25				25
Link Distance (ft)		273			989			826				981
Travel Time (s)		10.7			57.6			22.5				26.8
Confl. Peds. (#/hr)	207		358	358		207	244		349	349		244
Peak Hour Factor	0.93	0.93	0.93	0.84	0.84	0.84	0.86	0.86	0.86	0.86	0.86	0.86
Heavy Vehicles (%)	5%	5%	5%	7%	7%	7%	9%	9%	9%	8%	8%	8%
Adj. Flow (vph)	18	55	0	0	107	44	197	421	31	50	0	451
Shared Lane Traffic (%)							10%					
Lane Group Flow (vph)	18	55	0	0	151	0	177	472	0	50	0	451
Turn Type	Perm	NA			NA		Split	NA		Prot		Prot
Protected Phases		4			8		2	2		1		1
Permitted Phases	4									1		1
Detector Phase	4	4			8		2	2		1		1
Switch Phase												
Minimum Initial (s)	10.0	10.0			10.0		7.0	7.0		7.0		7.0
Minimum Split (s)	24.0	24.0			31.0		18.0	18.0		26.0		26.0
Total Split (s)	40.0	40.0			40.0		23.0	23.0		39.0		39.0
Total Split (%)	30.8%	30.8%			30.8%		17.7%	17.7%		30.0%		30.0%
Maximum Green (s)	33.8	33.8			33.8		17.1	17.1		33.4		33.4
Yellow Time (s)	3.2	3.2			3.2		3.1	3.1		3.0		3.0
All-Red Time (s)	3.0	3.0			3.0		2.8	2.8		2.6		2.6
Lost Time Adjust (s)	-1.2	-1.2			-1.2		-0.9	-0.9		-0.6		-0.6
Total Lost Time (s)	5.0	5.0			5.0		5.0	5.0		5.0		5.0
Lead/Lag							Lead	Lead		Lag		Lag
Lead-Lag Optimize?												
Vehicle Extension (s)	2.0	2.0			2.0		4.0	4.0		4.0		4.0
Recall Mode	None	None			None		C-Max	C-Max		None		None
Walk Time (s)	7.0	7.0			7.0		7.0	7.0		7.0		7.0
Flash Dont Walk (s)	10.0	10.0			17.0		5.0	5.0		13.0		13.0
Pedestrian Calls (#/hr)	0	0			0		0	0		0		0
Act Effect Green (s)	19.6	19.6			19.6		64.9	64.9		30.5		30.5

Lanes, Volumes, Timings

16: NC 86 (S. Columbia St) & W. Cameron Avenue/E. Cameron Avenue

09/01/2020

Lane Group	Ø9
Lane Configurations	
Traffic Volume (vph)	
Future Volume (vph)	
Ideal Flow (vphpl)	
Lane Width (ft)	
Grade (%)	
Storage Length (ft)	
Storage Lanes	
Taper Length (ft)	
Lane Util. Factor	
Ped Bike Factor	
Frt	
Flt Protected	
Satd. Flow (prot)	
Flt Permitted	
Satd. Flow (perm)	
Right Turn on Red	
Satd. Flow (RTOR)	
Link Speed (mph)	
Link Distance (ft)	
Travel Time (s)	
Confl. Peds. (#/hr)	
Peak Hour Factor	
Heavy Vehicles (%)	
Adj. Flow (vph)	
Shared Lane Traffic (%)	
Lane Group Flow (vph)	
Turn Type	
Protected Phases	9
Permitted Phases	
Detector Phase	
Switch Phase	
Minimum Initial (s)	7.0
Minimum Split (s)	28.0
Total Split (s)	28.0
Total Split (%)	22%
Maximum Green (s)	24.0
Yellow Time (s)	3.0
All-Red Time (s)	1.0
Lost Time Adjust (s)	
Total Lost Time (s)	
Lead/Lag	
Lead-Lag Optimize?	
Vehicle Extension (s)	0.2
Recall Mode	None
Walk Time (s)	7.0
Flash Dont Walk (s)	17.0
Pedestrian Calls (#/hr)	0
Act Effect Green (s)	

Lanes, Volumes, Timings

16: NC 86 (S. Columbia St) & W. Cameron Avenue/E. Cameron Avenue

09/01/2020

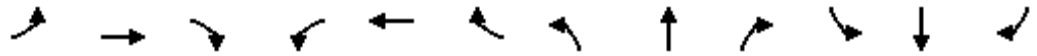

Lane Group	EBL	EBT	EBR	WBL	WBT	WBR	NBL	NBT	NBR	SBL	SBT	SBR
Actuated g/C Ratio	0.15	0.15			0.15		0.50	0.50		0.23		0.23
v/c Ratio	0.20	0.23			0.71		0.28	0.38		0.15		0.82
Control Delay	36.4	33.5			70.0		23.0	23.1		18.6		35.1
Queue Delay	0.0	0.0			0.0		0.0	0.0		0.0		0.0
Total Delay	36.4	33.5			70.0		23.0	23.1		18.6		35.1
LOS	D	C			E		C	C		B		D
Approach Delay		34.2			70.0			23.1				33.5
Approach LOS		C			E			C				C
Queue Length 50th (ft)	13	41			123		95	135		0		188
Queue Length 95th (ft)	m28	84			171		168	197		m37		269
Internal Link Dist (ft)		193			909			746				901
Turn Bay Length (ft)	100									310		
Base Capacity (vph)	158	436			377		628	1240		376		613
Starvation Cap Reductn	0	0			0		0	0		0		0
Spillback Cap Reductn	0	0			0		0	0		0		0
Storage Cap Reductn	0	0			0		0	0		0		0
Reduced v/c Ratio	0.11	0.13			0.40		0.28	0.38		0.13		0.74

Intersection Summary

Area Type: CBD
 Cycle Length: 130
 Actuated Cycle Length: 130
 Offset: 67 (52%), Referenced to phase 2:NBTL, Start of Green
 Natural Cycle: 105
 Control Type: Actuated-Coordinated
 Maximum v/c Ratio: 0.82
 Intersection Signal Delay: 32.6 Intersection LOS: C
 Intersection Capacity Utilization 67.9% ICU Level of Service C
 Analysis Period (min) 15
 m Volume for 95th percentile queue is metered by upstream signal.

Splits and Phases: 16: NC 86 (S. Columbia St) & W. Cameron Avenue/E. Cameron Avenue

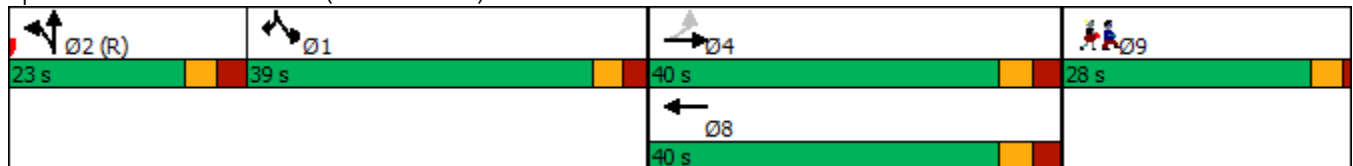

Lanes, Volumes, Timings

16: NC 86 (S. Columbia St) & W. Cameron Avenue/E. Cameron Avenue

09/01/2020

Lane Group	Ø9
Actuated g/C Ratio	
v/c Ratio	
Control Delay	
Queue Delay	
Total Delay	
LOS	
Approach Delay	
Approach LOS	
Queue Length 50th (ft)	
Queue Length 95th (ft)	
Internal Link Dist (ft)	
Turn Bay Length (ft)	
Base Capacity (vph)	
Starvation Cap Reductn	
Spillback Cap Reductn	
Storage Cap Reductn	
Reduced v/c Ratio	
Intersection Summary	

Lanes, Volumes, Timings

17: Raleigh Street & E. Cameron Avenue/Country Club Road

09/01/2020

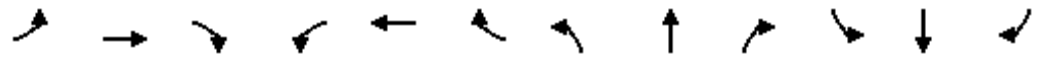

Lane Group	EBL	EBT	EBR	WBL	WBT	WBR	NBL	NBT	NBR	SBL	SBT	SBR
Lane Configurations		↔		↖	↗		↖	↗		↖	↗	
Traffic Volume (vph)	31	64	33	21	86	172	33	76	28	240	111	44
Future Volume (vph)	31	64	33	21	86	172	33	76	28	240	111	44
Ideal Flow (vphpl)	1900	1900	1900	1900	1900	1900	1900	1900	1900	1900	1900	1900
Grade (%)		-3%			3%			-2%			1%	
Storage Length (ft)	0		0	150		0	125		0	75		0
Storage Lanes	0		0	1		0	1		0	1		0
Taper Length (ft)	25			25			25			25		
Lane Util. Factor	1.00	1.00	1.00	1.00	1.00	1.00	1.00	1.00	1.00	1.00	1.00	1.00
Ped Bike Factor		0.91		0.90	0.87		0.67	0.95		0.87	0.85	
Frt		0.965			0.900			0.960			0.958	
Flt Protected		0.988		0.950			0.950			0.950		
Satd. Flow (prot)	0	1514	0	1569	1289	0	1505	1450	0	1554	1329	0
Flt Permitted		0.843		0.538			0.654			0.453		
Satd. Flow (perm)	0	1253	0	798	1289	0	697	1450	0	646	1329	0
Right Turn on Red			No			No			No			No
Satd. Flow (RTOR)												
Link Speed (mph)		25			25			25			25	
Link Distance (ft)		598			651			409			995	
Travel Time (s)		16.3			17.8			11.2			27.1	
Confl. Peds. (#/hr)	38		43	43		38	103		33	33		103
Peak Hour Factor	0.87	0.87	0.87	0.91	0.91	0.91	0.93	0.93	0.93	0.95	0.95	0.95
Heavy Vehicles (%)	2%	2%	2%	2%	2%	2%	9%	9%	9%	4%	4%	4%
Adj. Flow (vph)	36	74	38	23	95	189	35	82	30	253	117	46
Shared Lane Traffic (%)												
Lane Group Flow (vph)	0	148	0	23	284	0	35	112	0	253	163	0
Turn Type	Perm	NA		pm+pt	NA		pm+pt	NA		pm+pt	NA	
Protected Phases		2		1	6		3	8		7	4	
Permitted Phases	2			6			8			4		
Detector Phase	2	2		1	6		3	8		7	4	
Switch Phase												
Minimum Initial (s)	10.0	10.0		7.0	10.0		7.0	7.0		7.0	7.0	
Minimum Split (s)	18.0	18.0		13.0	19.0		13.0	19.0		12.0	16.0	
Total Split (s)	50.0	50.0		20.0	70.0		20.0	35.0		20.0	35.0	
Total Split (%)	40.0%	40.0%		16.0%	56.0%		16.0%	28.0%		16.0%	28.0%	
Maximum Green (s)	43.9	43.9		14.4	64.4		14.7	29.7		15.1	29.9	
Yellow Time (s)	3.3	3.3		3.0	3.1		3.0	3.1		3.0	3.1	
All-Red Time (s)	2.8	2.8		2.6	2.5		2.3	2.2		1.9	2.0	
Lost Time Adjust (s)		-1.1		-0.6	-0.6		-0.3	-0.3		0.1	-0.1	
Total Lost Time (s)		5.0		5.0	5.0		5.0	5.0		5.0	5.0	
Lead/Lag	Lag	Lag		Lead			Lead	Lag		Lead	Lag	
Lead-Lag Optimize?	Yes	Yes		Yes			Yes	Yes		Yes	Yes	
Vehicle Extension (s)	2.0	2.0		2.0	2.0		2.0	2.0		2.0	2.0	
Recall Mode	None	None		None	None		None	None		None	None	
Walk Time (s)	4.0	4.0			4.0			4.0			4.0	
Flash Dont Walk (s)	7.0	7.0			9.0			9.0			6.0	
Pedestrian Calls (#/hr)	0	0			0			0			0	
Act Effect Green (s)		16.3		19.9	19.9		15.9	10.5		24.9	21.1	
Actuated g/C Ratio		0.29		0.35	0.35		0.28	0.19		0.44	0.38	

Lanes, Volumes, Timings

17: Raleigh Street & E. Cameron Avenue/Country Club Road

09/01/2020



Lane Group	EBL	EBT	EBR	WBL	WBT	WBR	NBL	NBT	NBR	SBL	SBT	SBR
v/c Ratio		0.41		0.06	0.62		0.11	0.41		0.50	0.33	
Control Delay		25.4		13.7	23.1		12.5	30.1		15.1	19.1	
Queue Delay		0.0		0.0	0.0		0.0	0.0		0.0	0.0	
Total Delay		25.4		13.7	23.1		12.5	30.1		15.1	19.1	
LOS		C		B	C		B	C		B	B	
Approach Delay		25.4			22.4			25.9			16.6	
Approach LOS		C			C			C			B	
Queue Length 50th (ft)		39		6	85		5	35		45	28	
Queue Length 95th (ft)		110		19	172		25	95		131	118	
Internal Link Dist (ft)		518			571			329			915	
Turn Bay Length (ft)				150			125			75		
Base Capacity (vph)		993		544	1230		548	863		589	791	
Starvation Cap Reductn		0		0	0		0	0		0	0	
Spillback Cap Reductn		0		0	0		0	0		0	0	
Storage Cap Reductn		0		0	0		0	0		0	0	
Reduced v/c Ratio		0.15		0.04	0.23		0.06	0.13		0.43	0.21	

Intersection Summary

Area Type:	CBD
Cycle Length:	125
Actuated Cycle Length:	56.1
Natural Cycle:	65
Control Type:	Actuated-Uncoordinated
Maximum v/c Ratio:	0.62
Intersection Signal Delay:	21.0
Intersection LOS:	C
Intersection Capacity Utilization:	69.1%
ICU Level of Service:	C
Analysis Period (min):	15

Splits and Phases: 17: Raleigh Street & E. Cameron Avenue/Country Club Road



Lanes, Volumes, Timings
1: Church Street & W. Rosemary Street

09/01/2020



Lane Group	EBL	EBT	EBR	WBL	WBT	WBR	NBL	NBT	NBR	SBL	SBT	SBR
Lane Configurations		↕			↕			↕			↕	
Traffic Volume (vph)	24	420	65	55	432	37	47	79	63	24	75	26
Future Volume (vph)	24	420	65	55	432	37	47	79	63	24	75	26
Ideal Flow (vphpl)	1900	1900	1900	1900	1900	1900	1900	1900	1900	1900	1900	1900
Lane Width (ft)	12	14	12	12	14	12	12	12	12	12	12	12
Grade (%)		1%			-1%			0%			0%	
Lane Util. Factor	1.00	1.00	1.00	1.00	1.00	1.00	1.00	1.00	1.00	1.00	1.00	1.00
Ped Bike Factor		0.98			0.98			0.93			0.95	
Frt		0.983			0.990			0.955			0.972	
Flt Protected		0.998			0.995			0.988			0.990	
Satd. Flow (prot)	0	1710	0	0	1751	0	0	1516	0	0	1556	0
Flt Permitted		0.968			0.910			0.903			0.925	
Satd. Flow (perm)	0	1655	0	0	1594	0	0	1345	0	0	1435	0
Right Turn on Red			No			No			No			No
Satd. Flow (RTOR)												
Link Speed (mph)		20			20			25			25	
Link Distance (ft)		964			757			379			430	
Travel Time (s)		32.9			25.8			10.3			11.7	
Confl. Peds. (#/hr)	40		37	37		40	62		43	43		62
Peak Hour Factor	0.95	0.95	0.95	0.97	0.97	0.97	0.91	0.91	0.91	0.93	0.93	0.93
Adj. Flow (vph)	25	442	68	57	445	38	52	87	69	26	81	28
Shared Lane Traffic (%)												
Lane Group Flow (vph)	0	535	0	0	540	0	0	208	0	0	135	0
Turn Type	Perm	NA		Perm	NA		Perm	NA		Perm	NA	
Protected Phases		2			6			8			4	
Permitted Phases	2			6			8			4		
Detector Phase	2	2		6	6		8	8		4	4	
Switch Phase												
Minimum Initial (s)	10.0	10.0		10.0	10.0		7.0	7.0		7.0	7.0	
Minimum Split (s)	19.0	19.0		20.0	20.0		19.0	19.0		19.0	19.0	
Total Split (s)	45.0	45.0		45.0	45.0		25.0	25.0		25.0	25.0	
Total Split (%)	64.3%	64.3%		64.3%	64.3%		35.7%	35.7%		35.7%	35.7%	
Maximum Green (s)	40.5	40.5		40.4	40.4		20.1	20.1		20.1	20.1	
Yellow Time (s)	3.1	3.1		3.1	3.1		3.2	3.2		3.2	3.2	
All-Red Time (s)	1.4	1.4		1.5	1.5		1.7	1.7		1.7	1.7	
Lost Time Adjust (s)		0.5			0.4			0.1			0.1	
Total Lost Time (s)		5.0			5.0			5.0			5.0	
Lead/Lag												
Lead-Lag Optimize?												
Vehicle Extension (s)	3.0	3.0		3.0	3.0		3.0	3.0		3.0	3.0	
Recall Mode	C-Max	C-Max		C-Max	C-Max		None	None		None	None	
Walk Time (s)	4.0	4.0		4.0	4.0		4.0	4.0		4.0	4.0	
Flash Dont Walk (s)	5.0	5.0		6.0	6.0		10.0	10.0		10.0	10.0	
Pedestrian Calls (#/hr)	0	0		0	0		0	0		0	0	
Act Effct Green (s)		44.6			44.6			15.4			15.4	
Actuated g/C Ratio		0.64			0.64			0.22			0.22	
v/c Ratio		0.51			0.53			0.71			0.43	
Control Delay		9.9			5.9			36.9			26.6	
Queue Delay		0.0			0.0			0.0			0.0	

Lanes, Volumes, Timings
 1: Church Street & W. Rosemary Street

09/01/2020



Lane Group	EBL	EBT	EBR	WBL	WBT	WBR	NBL	NBT	NBR	SBL	SBT	SBR
Total Delay		9.9			5.9			36.9			26.6	
LOS		A			A			D			C	
Approach Delay		9.9			5.9			36.9			26.6	
Approach LOS		A			A			D			C	
Queue Length 50th (ft)		110			94			80			50	
Queue Length 95th (ft)		216			m94			m92			90	
Internal Link Dist (ft)		884			677			299			350	
Turn Bay Length (ft)												
Base Capacity (vph)		1054			1015			384			410	
Starvation Cap Reductn		0			0			0			0	
Spillback Cap Reductn		0			0			0			0	
Storage Cap Reductn		0			0			0			0	
Reduced v/c Ratio		0.51			0.53			0.54			0.33	

Intersection Summary

Area Type: CBD
 Cycle Length: 70
 Actuated Cycle Length: 70
 Offset: 25 (36%), Referenced to phase 2:EBTL and 6:WBTL, Start of Green
 Natural Cycle: 50
 Control Type: Actuated-Coordinated
 Maximum v/c Ratio: 0.71
 Intersection Signal Delay: 13.9
 Intersection LOS: B
 Intersection Capacity Utilization 77.6%
 ICU Level of Service D
 Analysis Period (min) 15
 m Volume for 95th percentile queue is metered by upstream signal.

Splits and Phases: 1: Church Street & W. Rosemary Street



Lanes, Volumes, Timings

2: NC 86 (N. Columbia St) & W. Rosemary Street/E. Rosemary Street

09/01/2020



Lane Group	EBL	EBT	EBR	WBL	WBT	WBR	NBL	NBT	NBR	SBL	SBT	SBR
Lane Configurations												
Traffic Volume (vph)	230	267	49	52	216	49	51	591	75	75	510	274
Future Volume (vph)	230	267	49	52	216	49	51	591	75	75	510	274
Ideal Flow (vphpl)	1900	1900	1900	1900	1900	1900	1900	1900	1900	1900	1900	1900
Lane Width (ft)	9	12	13	12	12	12	9	10	12	12	9	11
Grade (%)		1%			1%			-2%			8%	
Storage Length (ft)	100		0	150		0	75		0	150		400
Storage Lanes	1		0	1		0	1		0	1		1
Taper Length (ft)	25			25			25			25		
Lane Util. Factor	1.00	1.00	1.00	1.00	1.00	1.00	1.00	0.95	0.95	1.00	0.95	1.00
Ped Bike Factor	0.97	0.99		0.96	0.98		0.94	0.96				0.73
Frt		0.977			0.972			0.983				0.850
Flt Protected	0.950			0.950			0.950			0.950		
Satd. Flow (prot)	1426	1612	0	1585	1595	0	1420	2780	0	1514	2725	1310
Flt Permitted	0.187			0.547			0.356			0.252		
Satd. Flow (perm)	272	1612	0	879	1595	0	498	2780	0	402	2725	952
Right Turn on Red			No			No			No			No
Satd. Flow (RTOR)												
Link Speed (mph)		20			20			25			25	
Link Distance (ft)		757			339			353			476	
Travel Time (s)		25.8			11.6			9.6			13.0	
Confl. Peds. (#/hr)	49		36	36		49	59		83	83		59
Peak Hour Factor	0.88	0.88	0.88	0.94	0.94	0.94	0.83	0.83	0.83	0.82	0.82	0.82
Heavy Vehicles (%)	2%	2%	2%	2%	2%	2%	4%	4%	4%	3%	3%	3%
Adj. Flow (vph)	261	303	56	55	230	52	61	712	90	91	622	334
Shared Lane Traffic (%)												
Lane Group Flow (vph)	261	359	0	55	282	0	61	802	0	91	622	334
Turn Type	pm+pt	NA		Perm	NA		pm+pt	NA		pm+pt	NA	pm+ov
Protected Phases	7	4			8		5	2		1	6	7
Permitted Phases	4			8			2			6		6
Detector Phase	7	4		8	8		5	2		1	6	7
Switch Phase												
Minimum Initial (s)	7.0	7.0		7.0	7.0		7.0	10.0		7.0	10.0	7.0
Minimum Split (s)	13.0	31.0		32.0	32.0		13.0	23.0		13.0	22.0	13.0
Total Split (s)	24.0	56.0		32.0	32.0		20.0	64.0		20.0	64.0	24.0
Total Split (%)	17.1%	40.0%		22.9%	22.9%		14.3%	45.7%		14.3%	45.7%	17.1%
Maximum Green (s)	18.2	50.0		26.0	26.0		14.2	58.2		14.9	58.2	18.2
Yellow Time (s)	3.0	3.2		3.2	3.2		3.0	3.3		3.0	3.3	3.0
All-Red Time (s)	2.8	2.8		2.8	2.8		2.8	2.5		2.1	2.5	2.8
Lost Time Adjust (s)	-0.8	-1.0		-1.0	-1.0		-1.0	-0.8		-0.1	-0.8	-0.8
Total Lost Time (s)	5.0	5.0		5.0	5.0		4.8	5.0		5.0	5.0	5.0
Lead/Lag	Lead			Lag	Lag		Lead	Lag		Lead	Lag	Lead
Lead-Lag Optimize?												
Vehicle Extension (s)	1.0	1.0		1.0	1.0		1.0	3.0		1.0	3.0	1.0
Recall Mode	None	None		None	None		None	C-Max		None	C-Max	None
Walk Time (s)		7.0		7.0	7.0			7.0			7.0	
Flash Dont Walk (s)		18.0		19.0	19.0			10.0			9.0	
Pedestrian Calls (#/hr)		0		0	0			0			0	
Act Effect Green (s)	50.2	50.2		26.2	26.2		75.2	66.6		75.9	69.2	88.2

Lanes, Volumes, Timings

2: NC 86 (N. Columbia St) & W. Rosemary Street/E. Rosemary Street

09/01/2020



Lane Group	EBL	EBT	EBR	WBL	WBT	WBR	NBL	NBT	NBR	SBL	SBT	SBR
Actuated g/C Ratio	0.36	0.36		0.19	0.19		0.54	0.48		0.54	0.49	0.63
v/c Ratio	1.03	0.62		0.34	0.95		0.19	0.61		0.32	0.46	0.52
Control Delay	100.5	44.3		54.3	92.9		5.6	7.8		17.3	25.6	16.9
Queue Delay	0.0	0.0		0.0	0.0		0.0	2.3		0.0	0.0	0.0
Total Delay	100.5	44.3		54.3	92.9		5.6	10.1		17.3	25.6	16.9
LOS	F	D		D	F		A	B		B	C	B
Approach Delay		67.9			86.6			9.8			22.1	
Approach LOS		E			F			A			C	
Queue Length 50th (ft)	~207	288		39	235		7	50		37	199	137
Queue Length 95th (ft)	#354	399		93	#427		m8	m52		59	230	181
Internal Link Dist (ft)		677			259			273			396	
Turn Bay Length (ft)	100			150			75			150		400
Base Capacity (vph)	254	587		169	307		384	1323		347	1346	647
Starvation Cap Reductn	0	0		0	0		0	373		0	0	0
Spillback Cap Reductn	0	0		0	0		0	0		0	33	0
Storage Cap Reductn	0	0		0	0		0	0		0	0	0
Reduced v/c Ratio	1.03	0.61		0.33	0.92		0.16	0.84		0.26	0.47	0.52

Intersection Summary

Area Type: CBD
 Cycle Length: 140
 Actuated Cycle Length: 140
 Offset: 62 (44%), Referenced to phase 2:NBTL and 6:SBTL, Start of Green
 Natural Cycle: 85
 Control Type: Actuated-Coordinated
 Maximum v/c Ratio: 1.03
 Intersection Signal Delay: 35.9 Intersection LOS: D
 Intersection Capacity Utilization 78.8% ICU Level of Service D
 Analysis Period (min) 15
 ~ Volume exceeds capacity, queue is theoretically infinite.
 Queue shown is maximum after two cycles.
 # 95th percentile volume exceeds capacity, queue may be longer.
 Queue shown is maximum after two cycles.
 m Volume for 95th percentile queue is metered by upstream signal.

Splits and Phases: 2: NC 86 (N. Columbia St) & W. Rosemary Street/E. Rosemary Street

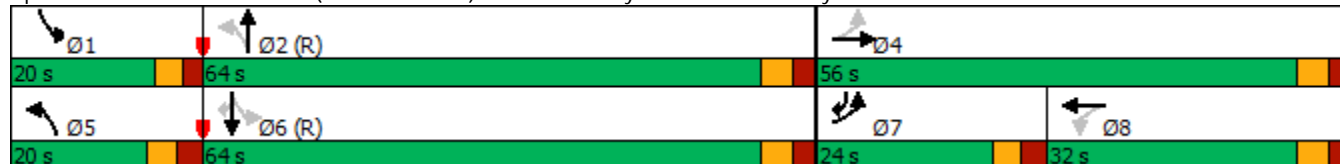

Lanes, Volumes, Timings
6: Henderson Street & E. Rosemary Street

09/01/2020



Lane Group	EBL	EBT	EBR	WBL	WBT	WBR	NBL	NBT	NBR	SBL	SBT	SBR
Lane Configurations												
Traffic Volume (vph)	43	293	175	12	198	57	66	24	5	23	41	10
Future Volume (vph)	43	293	175	12	198	57	66	24	5	23	41	10
Ideal Flow (vphpl)	1900	1900	1900	1900	1900	1900	1900	1900	1900	1900	1900	1900
Grade (%)		0%			0%			0%				3%
Storage Length (ft)	85		0	0		0	0		0	0		0
Storage Lanes	1		0	0		0	0		0	0		0
Taper Length (ft)	25			25			25			25		
Lane Util. Factor	1.00	1.00	1.00	1.00	1.00	1.00	1.00	1.00	1.00	1.00	1.00	1.00
Ped Bike Factor	0.98	0.95			0.99			0.87			0.94	
Frt		0.944			0.971			0.993			0.981	
Flt Protected	0.950				0.998			0.966			0.985	
Satd. Flow (prot)	1593	1508	0	0	1603	0	0	1596	0	0	1549	0
Flt Permitted	0.620				0.977			0.791			0.892	
Satd. Flow (perm)	1017	1508	0	0	1569	0	0	1150	0	0	1355	0
Right Turn on Red			No			No			No			No
Satd. Flow (RTOR)												
Link Speed (mph)		20			20			20			20	
Link Distance (ft)		156			1195			366			450	
Travel Time (s)		5.3			40.7			12.5			15.3	
Confl. Peds. (#/hr)	14		34	34		14	73		51	51		73
Peak Hour Factor	0.90	0.90	0.90	0.93	0.93	0.93	0.67	0.67	0.67	0.79	0.79	0.79
Adj. Flow (vph)	48	326	194	13	213	61	99	36	7	29	52	13
Shared Lane Traffic (%)												
Lane Group Flow (vph)	48	520	0	0	287	0	0	142	0	0	94	0
Turn Type	Perm	NA		Perm	NA		Perm	NA		Perm	NA	
Protected Phases		2			2			4			4	
Permitted Phases	2			2			4			4		
Detector Phase	2	2		2	2		4	4		4	4	
Switch Phase												
Minimum Initial (s)	11.0	11.0		11.0	11.0		8.0	8.0		8.0	8.0	
Minimum Split (s)	15.9	15.9		15.9	15.9		17.8	17.8		17.8	17.8	
Total Split (s)	32.0	32.0		32.0	32.0		38.0	38.0		38.0	38.0	
Total Split (%)	45.7%	45.7%		45.7%	45.7%		54.3%	54.3%		54.3%	54.3%	
Maximum Green (s)	27.1	27.1		27.1	27.1		33.2	33.2		33.2	33.2	
Yellow Time (s)	3.3	3.3		3.3	3.3		3.3	3.3		3.3	3.3	
All-Red Time (s)	1.6	1.6		1.6	1.6		1.5	1.5		1.5	1.5	
Lost Time Adjust (s)	0.1	0.0			0.1			0.2			0.2	
Total Lost Time (s)	5.0	4.9			5.0			5.0			5.0	
Lead/Lag												
Lead-Lag Optimize?												
Vehicle Extension (s)	2.0	2.0		2.0	2.0		2.0	2.0		2.0	2.0	
Recall Mode	C-Max	C-Max		C-Max	C-Max		None	None		None	None	
Walk Time (s)	4.0	4.0		4.0	4.0		4.0	4.0		4.0	4.0	
Flash Dont Walk (s)	7.0	7.0		7.0	7.0		9.0	9.0		9.0	9.0	
Pedestrian Calls (#/hr)	0	0		0	0		0	0		0	0	
Act Effct Green (s)	49.8	49.9			49.8			13.7			13.7	
Actuated g/C Ratio	0.71	0.71			0.71			0.20			0.20	
v/c Ratio	0.07	0.48			0.26			0.63			0.35	

Lanes, Volumes, Timings
 6: Henderson Street & E. Rosemary Street

09/01/2020



Lane Group	EBL	EBT	EBR	WBL	WBT	WBR	NBL	NBT	NBR	SBL	SBT	SBR
Control Delay	6.1	7.8			5.2			28.4			26.2	
Queue Delay	0.0	0.0			0.0			0.0			0.0	
Total Delay	6.1	7.8			5.2			28.4			26.2	
LOS	A	A			A			C			C	
Approach Delay		7.7			5.2			28.4			26.2	
Approach LOS		A			A			C			C	
Queue Length 50th (ft)	6	87			57			52			36	
Queue Length 95th (ft)	m22	231			113			41			56	
Internal Link Dist (ft)		76			1115			286			370	
Turn Bay Length (ft)	85											
Base Capacity (vph)	723	1075			1116			542			638	
Starvation Cap Reductn	0	0			0			0			0	
Spillback Cap Reductn	0	0			0			0			0	
Storage Cap Reductn	0	0			0			0			0	
Reduced v/c Ratio	0.07	0.48			0.26			0.26			0.15	

Intersection Summary

Area Type: CBD
 Cycle Length: 70
 Actuated Cycle Length: 70
 Offset: 14 (20%), Referenced to phase 2:EBWB, Start of Green
 Natural Cycle: 55
 Control Type: Actuated-Coordinated
 Maximum v/c Ratio: 0.63
 Intersection Signal Delay: 11.3 Intersection LOS: B
 Intersection Capacity Utilization 50.3% ICU Level of Service A
 Analysis Period (min) 15
 m Volume for 95th percentile queue is metered by upstream signal.

Splits and Phases: 6: Henderson Street & E. Rosemary Street

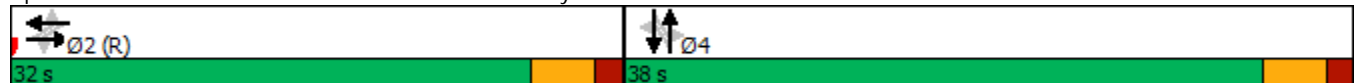

Lanes, Volumes, Timings
7: Hillsborough Street & E. Rosemary Street

09/01/2020



Lane Group	EBL	EBT	EBR	WBL	WBT	WBR	NBL	NBT	NBR	SBL	SBT	SBR
Lane Configurations		↕			↕		↗	↘		↗	↘	
Traffic Volume (vph)	39	135	85	10	99	56	166	295	23	37	203	27
Future Volume (vph)	39	135	85	10	99	56	166	295	23	37	203	27
Ideal Flow (vphpl)	1900	1900	1900	1900	1900	1900	1900	1900	1900	1900	1900	1900
Storage Length (ft)	0		0	0		0	100		0	100		0
Storage Lanes	0		0	0		0	1		0	1		0
Taper Length (ft)	25			25			25			25		
Lane Util. Factor	1.00	1.00	1.00	1.00	1.00	1.00	1.00	1.00	1.00	1.00	1.00	1.00
Ped Bike Factor		0.98			0.97		0.92	1.00		0.98	0.98	
Frt		0.956			0.954			0.989			0.982	
Flt Protected		0.993			0.997		0.950			0.950		
Satd. Flow (prot)	0	1738	0	0	1713	0	1770	1835	0	1770	1787	0
Flt Permitted		0.928			0.975		0.502			0.553		
Satd. Flow (perm)	0	1612	0	0	1674	0	859	1835	0	1010	1787	0
Right Turn on Red			No			No			No			No
Satd. Flow (RTOR)												
Link Speed (mph)		20			20			25			25	
Link Distance (ft)		1195			527			363			726	
Travel Time (s)		40.7			18.0			9.9			19.8	
Confl. Peds. (#/hr)	27		14	14		27	52		9	9		52
Peak Hour Factor	0.86	0.86	0.86	0.79	0.79	0.79	0.92	0.92	0.92	0.96	0.96	0.96
Adj. Flow (vph)	45	157	99	13	125	71	180	321	25	39	211	28
Shared Lane Traffic (%)												
Lane Group Flow (vph)	0	301	0	0	209	0	180	346	0	39	239	0
Turn Type	Perm	NA		Perm	NA		pm+pt	NA		Perm	NA	
Protected Phases		4			8		5	2			6	
Permitted Phases	4			8			2			6		
Detector Phase	4	4		8	8		5	2		6	6	
Switch Phase												
Minimum Initial (s)	7.0	7.0		7.0	7.0		7.0	10.0		10.0	10.0	
Minimum Split (s)	20.0	20.0		17.0	17.0		12.0	15.0		15.0	15.0	
Total Split (s)	30.0	30.0		30.0	30.0		14.0	40.0		26.0	26.0	
Total Split (%)	42.9%	42.9%		42.9%	42.9%		20.0%	57.1%		37.1%	37.1%	
Maximum Green (s)	25.1	25.1		25.0	25.0		9.2	35.2		21.2	21.2	
Yellow Time (s)	3.0	3.0		3.3	3.3		3.0	3.3		3.1	3.1	
All-Red Time (s)	1.9	1.9		1.7	1.7		1.8	1.5		1.7	1.7	
Lost Time Adjust (s)		0.1			0.0		0.2	0.2		0.2	0.2	
Total Lost Time (s)		5.0			5.0		5.0	5.0		5.0	5.0	
Lead/Lag							Lead			Lag	Lag	
Lead-Lag Optimize?												
Vehicle Extension (s)	2.0	2.0		2.0	2.0		2.0	2.0		2.0	2.0	
Recall Mode	None	None		None	None		None	C-Max		C-Max	C-Max	
Walk Time (s)	4.0	4.0		4.0	4.0			4.0		4.0	4.0	
Flash Dont Walk (s)	11.0	11.0		8.0	8.0			6.0		6.0	6.0	
Pedestrian Calls (#/hr)	0	0		0	0			0		0	0	
Act Effct Green (s)		17.5			17.5		42.5	42.5		29.7	29.7	
Actuated g/C Ratio		0.25			0.25		0.61	0.61		0.42	0.42	
v/c Ratio		0.75			0.50		0.29	0.31		0.09	0.32	
Control Delay		30.0			25.6		6.9	7.2		16.2	17.0	

Lanes, Volumes, Timings
 7: Hillsborough Street & E. Rosemary Street

09/01/2020



Lane Group	EBL	EBT	EBR	WBL	WBT	WBR	NBL	NBT	NBR	SBL	SBT	SBR
Queue Delay		0.0			0.0		0.0	0.3		0.0	0.0	
Total Delay		30.0			25.6		6.9	7.5		16.2	17.0	
LOS		C			C		A	A		B	B	
Approach Delay		30.0			25.6			7.3			16.9	
Approach LOS		C			C			A			B	
Queue Length 50th (ft)		126			77		36	86		10	65	
Queue Length 95th (ft)		119			100		71	152		34	144	
Internal Link Dist (ft)		1115			447			283			646	
Turn Bay Length (ft)							100			100		
Base Capacity (vph)		575			597		640	1115		428	758	
Starvation Cap Reductn		0			0		0	322		0	0	
Spillback Cap Reductn		0			0		0	0		0	0	
Storage Cap Reductn		0			0		0	0		0	0	
Reduced v/c Ratio		0.52			0.35		0.28	0.44		0.09	0.32	

Intersection Summary

Area Type:	Other
Cycle Length:	70
Actuated Cycle Length:	70
Offset:	32 (46%), Referenced to phase 2:NBTL and 6:SBTL, Start of Green
Natural Cycle:	50
Control Type:	Actuated-Coordinated
Maximum v/c Ratio:	0.75
Intersection Signal Delay:	17.4
Intersection LOS:	B
Intersection Capacity Utilization	64.0%
ICU Level of Service	C
Analysis Period (min)	15

Splits and Phases: 7: Hillsborough Street & E. Rosemary Street



Lanes, Volumes, Timings

8: Carolina Square Driveway/Church Street & W. Franklin Street

09/01/2020



Lane Group	EBL	EBT	EBR	WBL	WBT	WBR	NBL	NBT	NBR	SBL	SBT	SBR
Lane Configurations												
Traffic Volume (vph)	65	461	18	41	563	72	24	48	40	73	59	71
Future Volume (vph)	65	461	18	41	563	72	24	48	40	73	59	71
Ideal Flow (vphpl)	1900	1900	1900	1900	1900	1900	1900	1900	1900	1900	1900	1900
Lane Width (ft)	10	10	16	10	10	10	12	12	12	12	12	12
Grade (%)		2%			-2%			-4%				-3%
Storage Length (ft)	150		0	200		0	0		100	0		0
Storage Lanes	1		0	1		0	0		1	0		0
Taper Length (ft)	25			25			25			25		
Lane Util. Factor	1.00	1.00	1.00	1.00	1.00	1.00	1.00	1.00	1.00	1.00	1.00	1.00
Ped Bike Factor		0.99		0.88	0.96			0.94	0.88		0.86	
Frt		0.994			0.983				0.850		0.953	
Flt Protected	0.950			0.950				0.983			0.982	
Satd. Flow (prot)	1457	1503	0	1501	1493	0	0	1681	1454	0	1422	0
Flt Permitted	0.290			0.395				0.867			0.849	
Satd. Flow (perm)	445	1503	0	547	1493	0	0	1388	1282	0	1190	0
Right Turn on Red			No			No			No			No
Satd. Flow (RTOR)												
Link Speed (mph)		20			20			20			25	
Link Distance (ft)		993			294			285			379	
Travel Time (s)		33.9			10.0			9.7			10.3	
Confl. Peds. (#/hr)	124		164	164		124	175		63	63		175
Peak Hour Factor	0.91	0.91	0.91	0.93	0.93	0.93	0.81	0.81	0.81	0.91	0.91	0.91
Heavy Vehicles (%)	3%	3%	3%	2%	2%	2%	2%	2%	2%	2%	2%	2%
Adj. Flow (vph)	71	507	20	44	605	77	30	59	49	80	65	78
Shared Lane Traffic (%)												
Lane Group Flow (vph)	71	527	0	44	682	0	0	89	49	0	223	0
Turn Type	Perm	NA		Perm	NA		Perm	NA	Perm	Perm	NA	
Protected Phases		2			6			8			4	
Permitted Phases	2			6			8		8	4		
Detector Phase	2	2		6	6		8	8	8	4	4	
Switch Phase												
Minimum Initial (s)	10.0	10.0		10.0	10.0		7.0	7.0	7.0	7.0	7.0	
Minimum Split (s)	22.0	22.0		19.0	19.0		29.0	29.0	29.0	27.0	27.0	
Total Split (s)	41.0	41.0		41.0	41.0		29.0	29.0	29.0	29.0	29.0	
Total Split (%)	58.6%	58.6%		58.6%	58.6%		41.4%	41.4%	41.4%	41.4%	41.4%	
Maximum Green (s)	35.4	35.4		35.4	35.4		22.7	22.7	22.7	23.0	23.0	
Yellow Time (s)	3.3	3.3		3.3	3.3		3.1	3.1	3.1	3.4	3.4	
All-Red Time (s)	2.3	2.3		2.3	2.3		3.2	3.2	3.2	2.6	2.6	
Lost Time Adjust (s)	-0.6	-0.6		-0.6	-0.6			-1.3	-1.3		-1.0	
Total Lost Time (s)	5.0	5.0		5.0	5.0			5.0	5.0		5.0	
Lead/Lag												
Lead-Lag Optimize?												
Vehicle Extension (s)	3.0	3.0		3.0	3.0		2.0	2.0	2.0	2.0	2.0	
Recall Mode	C-Max	C-Max		C-Max	C-Max		None	None	None	None	None	
Walk Time (s)	7.0	7.0		7.0	7.0		7.0	7.0	7.0	7.0	7.0	
Flash Dont Walk (s)	9.0	9.0		6.0	6.0		15.0	15.0	15.0	14.0	14.0	
Pedestrian Calls (#/hr)	0	0		0	0		0	0	0	0	0	
Act Effect Green (s)	42.1	42.1		42.1	42.1			17.9	17.9		17.9	

Lanes, Volumes, Timings

8: Carolina Square Driveway/Church Street & W. Franklin Street

09/01/2020



Lane Group	EBL	EBT	EBR	WBL	WBT	WBR	NBL	NBT	NBR	SBL	SBT	SBR
Actuated g/C Ratio	0.60	0.60		0.60	0.60			0.26	0.26		0.26	
v/c Ratio	0.27	0.58		0.13	0.76			0.25	0.15		0.74	
Control Delay	12.0	13.3		9.9	17.4			20.6	19.0		35.4	
Queue Delay	0.0	0.0		0.0	0.0			0.0	0.0		0.0	
Total Delay	12.0	13.3		9.9	17.4			20.6	19.0		35.4	
LOS	B	B		A	B			C	B		D	
Approach Delay		13.2			16.9			20.0			35.4	
Approach LOS		B			B			C			D	
Queue Length 50th (ft)	13	126		15	322			30	16		100	
Queue Length 95th (ft)	45	268		m18	m323			51	32		110	
Internal Link Dist (ft)		913			214			205			299	
Turn Bay Length (ft)	150			200					100			
Base Capacity (vph)	267	904		329	898			475	439		408	
Starvation Cap Reductn	0	0		0	0			0	0		0	
Spillback Cap Reductn	0	0		0	0			0	0		0	
Storage Cap Reductn	0	0		0	0			0	0		0	
Reduced v/c Ratio	0.27	0.58		0.13	0.76			0.19	0.11		0.55	

Intersection Summary

Area Type:	CBD
Cycle Length:	70
Actuated Cycle Length:	70
Offset:	66 (94%), Referenced to phase 2:EBTL and 6:WBTL, Start of Green
Natural Cycle:	70
Control Type:	Actuated-Coordinated
Maximum v/c Ratio:	0.76
Intersection Signal Delay:	18.3
Intersection LOS:	B
Intersection Capacity Utilization:	81.4%
ICU Level of Service:	D
Analysis Period (min):	15
m Volume for 95th percentile queue is metered by upstream signal.	

Splits and Phases: 8: Carolina Square Driveway/Church Street & W. Franklin Street

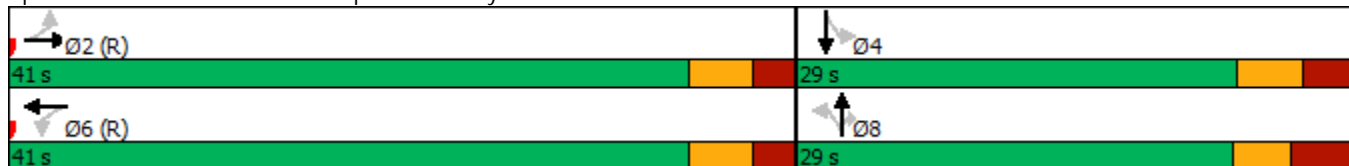

Lanes, Volumes, Timings

9: NC 86 (S. Columbia St)/NC 86 (N. Columbia St) & W. Franklin Street/E. Franklin Street 09/01/2020



Lane Group	EBL	EBT	EBR	WBL	WBT	WBR	NBL	NBT	NBR	SBL	SBT	SBR
Lane Configurations												
Traffic Volume (vph)	176	430	75	101	514	66	64	549	112	73	382	117
Future Volume (vph)	176	430	75	101	514	66	64	549	112	73	382	117
Ideal Flow (vphpl)	1900	1900	1900	1900	1900	1900	1900	1900	1900	1900	1900	1900
Lane Width (ft)	9	12	13	10	10	13	9	10	10	9	9	11
Grade (%)		3%			1%			-2%			3%	
Storage Length (ft)	250		0	125		0	475		0	125		0
Storage Lanes	1		0	1		1	1		0	1		0
Taper Length (ft)	25			25			25			25		
Lane Util. Factor	1.00	0.95	0.95	1.00	1.00	1.00	1.00	0.95	0.95	1.00	0.95	0.95
Ped Bike Factor	0.87	0.96		0.87		0.68	0.90	0.96		0.93	0.95	
Frt		0.978				0.850		0.975			0.965	
Flt Protected	0.950			0.950			0.950			0.950		
Satd. Flow (prot)	1412	2934	0	1479	1557	1465	1380	2690	0	1385	2529	0
Flt Permitted	0.950			0.950			0.950			0.950		
Satd. Flow (perm)	1223	2934	0	1287	1557	997	1239	2690	0	1282	2529	0
Right Turn on Red			No			No			No			No
Satd. Flow (RTOR)												
Link Speed (mph)		20			20			25			25	
Link Distance (ft)		461			941			981			353	
Travel Time (s)		15.7			32.1			26.8			9.6	
Confl. Peds. (#/hr)	193		152	152		193	67		108	108		67
Peak Hour Factor	0.87	0.87	0.87	0.84	0.84	0.84	0.90	0.90	0.90	0.94	0.94	0.94
Heavy Vehicles (%)	2%	2%	2%	2%	2%	2%	7%	7%	7%	4%	4%	4%
Adj. Flow (vph)	202	494	86	120	612	79	71	610	124	78	406	124
Shared Lane Traffic (%)												
Lane Group Flow (vph)	202	580	0	120	612	79	71	734	0	78	530	0
Turn Type	Prot	NA		Prot	NA	pm+ov	Prot	NA		Prot	NA	
Protected Phases	5	2		1	6	7	3	8		7	4	
Permitted Phases						6						
Detector Phase	5	2		1	6	7	3	8		7	4	
Switch Phase												
Minimum Initial (s)	7.0	10.0		7.0	10.0	7.0	7.0	7.0		7.0	7.0	
Minimum Split (s)	15.0	28.2		15.0	28.2	15.0	15.0	28.0		15.0	28.1	
Total Split (s)	22.0	36.0		43.0	57.0	15.0	21.0	46.0		15.0	40.0	
Total Split (%)	15.7%	25.7%		30.7%	40.7%	10.7%	15.0%	32.9%		10.7%	28.6%	
Maximum Green (s)	16.6	29.8		37.1	50.8	9.1	15.1	40.1		9.1	34.3	
Yellow Time (s)	3.0	3.0		3.0	3.0	3.0	3.0	3.3		3.0	3.1	
All-Red Time (s)	2.4	3.2		2.9	3.2	2.9	2.9	2.6		2.9	2.6	
Lost Time Adjust (s)	-0.4	-1.2		-0.9	-1.2	-2.0	-0.9	-0.9		-0.9	-0.7	
Total Lost Time (s)	5.0	5.0		5.0	5.0	3.9	5.0	5.0		5.0	5.0	
Lead/Lag	Lead	Lag		Lead	Lag	Lead	Lead	Lag		Lead	Lag	
Lead-Lag Optimize?	Yes	Yes		Yes	Yes	Yes	Yes	Yes		Yes	Yes	
Vehicle Extension (s)	1.0	3.0		1.0	3.0	1.0	1.0	2.0		1.0	2.0	
Recall Mode	None	C-Max		None	C-Max	None	None	Ped		None	Ped	
Walk Time (s)		7.0			7.0			7.0			7.0	
Flash Dont Walk (s)		15.0			15.0			15.0			15.0	
Pedestrian Calls (#/hr)		0			0			0			0	
Act Effect Green (s)	18.3	54.5		15.8	52.0	63.8	11.7	40.2		9.6	40.6	

Lanes, Volumes, Timings

9: NC 86 (S. Columbia St)/NC 86 (N. Columbia St) & W. Franklin Street/E. Franklin Street 09/01/2020



Lane Group	EBL	EBT	EBR	WBL	WBT	WBR	NBL	NBT	NBR	SBL	SBT	SBR
Actuated g/C Ratio	0.13	0.39		0.11	0.37	0.46	0.08	0.29		0.07	0.29	
v/c Ratio	1.10	0.51		0.72	1.06	0.16	0.62	0.95		0.83	0.72	
Control Delay	145.4	35.8		93.2	88.5	21.6	98.8	31.4		131.6	34.9	
Queue Delay	0.0	0.0		0.0	0.0	0.0	0.0	0.0		0.0	0.6	
Total Delay	145.4	35.8		93.2	88.5	21.6	98.8	31.4		131.6	35.5	
LOS	F	D		F	F	C	F	C		F	D	
Approach Delay		64.1			82.7			37.3			47.8	
Approach LOS		E			F			D			D	
Queue Length 50th (ft)	~222	196		113	-628	30	56	337		75	104	
Queue Length 95th (ft)	#364	297		167	#770	m56	m63	m#418		m#168	#232	
Internal Link Dist (ft)		381			861			901			273	
Turn Bay Length (ft)	250			125			475			125		
Base Capacity (vph)	184	1141		401	578	494	157	787		98	734	
Starvation Cap Reductn	0	0		0	0	0	0	0		0	41	
Spillback Cap Reductn	0	0		0	0	0	0	0		0	0	
Storage Cap Reductn	0	0		0	0	0	0	0		0	0	
Reduced v/c Ratio	1.10	0.51		0.30	1.06	0.16	0.45	0.93		0.80	0.76	

Intersection Summary

Area Type: CBD
 Cycle Length: 140
 Actuated Cycle Length: 140
 Offset: 0 (0%), Referenced to phase 2:EBT and 6:WBT, Start of Green
 Natural Cycle: 150
 Control Type: Actuated-Coordinated
 Maximum v/c Ratio: 1.10
 Intersection Signal Delay: 58.7 Intersection LOS: E
 Intersection Capacity Utilization 85.3% ICU Level of Service E
 Analysis Period (min) 15
 ~ Volume exceeds capacity, queue is theoretically infinite.
 Queue shown is maximum after two cycles.
 # 95th percentile volume exceeds capacity, queue may be longer.
 Queue shown is maximum after two cycles.
 m Volume for 95th percentile queue is metered by upstream signal.

Splits and Phases: 9: NC 86 (S. Columbia St)/NC 86 (N. Columbia St) & W. Franklin Street/E. Franklin Street



Lanes, Volumes, Timings
 10: E. Franklin Street & Henderson Street

09/01/2020



Lane Group	EBL	EBT	WBT	WBR	SBL	SBR
Lane Configurations		↑↑	↑↑		↑↑	
Traffic Volume (vph)	34	601	648	70	172	57
Future Volume (vph)	34	601	648	70	172	57
Ideal Flow (vphpl)	1900	1900	1900	1900	1900	1900
Lane Width (ft)	10	13	10	10	11	11
Grade (%)		-2%	2%		3%	
Lane Util. Factor	0.95	0.95	0.95	0.95	1.00	1.00
Ped Bike Factor		1.00	0.97		0.87	
Frt			0.985		0.966	
Flt Protected		0.997			0.964	
Satd. Flow (prot)	0	3282	2820	0	1402	0
Flt Permitted		0.884			0.964	
Satd. Flow (perm)	0	2898	2820	0	1300	0
Right Turn on Red				No		No
Satd. Flow (RTOR)						
Link Speed (mph)		20	20		20	
Link Distance (ft)		941	1200		366	
Travel Time (s)		32.1	40.9		12.5	
Confl. Peds. (#/hr)	114			114	88	198
Peak Hour Factor	0.90	0.90	0.93	0.93	0.83	0.83
Heavy Vehicles (%)	3%	3%	2%	2%	2%	2%
Parking (#/hr)						0
Adj. Flow (vph)	38	668	697	75	207	69
Shared Lane Traffic (%)						
Lane Group Flow (vph)	0	706	772	0	276	0
Turn Type	Perm	NA	NA		Prot	
Protected Phases		2	6		4	
Permitted Phases	2					
Detector Phase	2	2	6		4	
Switch Phase						
Minimum Initial (s)	10.0	10.0	10.0		7.0	
Minimum Split (s)	16.2	16.2	21.1		24.1	
Total Split (s)	43.0	43.0	43.0		27.0	
Total Split (%)	61.4%	61.4%	61.4%		38.6%	
Maximum Green (s)	36.8	36.8	36.9		21.9	
Yellow Time (s)	3.0	3.0	3.0		3.0	
All-Red Time (s)	3.2	3.2	3.1		2.1	
Lost Time Adjust (s)		-1.2	-1.1		-0.1	
Total Lost Time (s)		5.0	5.0		5.0	
Lead/Lag						
Lead-Lag Optimize?						
Vehicle Extension (s)	2.0	2.0	2.0		1.0	
Recall Mode	C-Max	C-Max	C-Max		None	
Walk Time (s)			7.0		7.0	
Flash Dont Walk (s)			8.0		12.0	
Pedestrian Calls (#/hr)			0		0	
Act Effct Green (s)		43.2	43.2		16.8	
Actuated g/C Ratio		0.62	0.62		0.24	
v/c Ratio		0.39	0.44		0.82	

Lanes, Volumes, Timings
 10: E. Franklin Street & Henderson Street

09/01/2020



Lane Group	EBL	EBT	WBT	WBR	SBL	SBR
Control Delay		9.7	5.9		44.1	
Queue Delay		0.0	0.0		0.0	
Total Delay		9.7	5.9		44.1	
LOS		A	A		D	
Approach Delay		9.7	5.9		44.1	
Approach LOS		A	A		D	
Queue Length 50th (ft)		188	73		115	
Queue Length 95th (ft)		m182	154		137	
Internal Link Dist (ft)		861	1120		286	
Turn Bay Length (ft)						
Base Capacity (vph)		1790	1742		440	
Starvation Cap Reductn		0	0		0	
Spillback Cap Reductn		0	0		0	
Storage Cap Reductn		0	0		0	
Reduced v/c Ratio		0.39	0.44		0.63	

Intersection Summary

Area Type: CBD
 Cycle Length: 70
 Actuated Cycle Length: 70
 Offset: 27 (39%), Referenced to phase 2:EBTL and 6:WBT, Start of Green
 Natural Cycle: 50
 Control Type: Actuated-Coordinated
 Maximum v/c Ratio: 0.82
 Intersection Signal Delay: 13.5
 Intersection LOS: B
 Intersection Capacity Utilization 71.4%
 ICU Level of Service C
 Analysis Period (min) 15
 m Volume for 95th percentile queue is metered by upstream signal.

Splits and Phases: 10: E. Franklin Street & Henderson Street

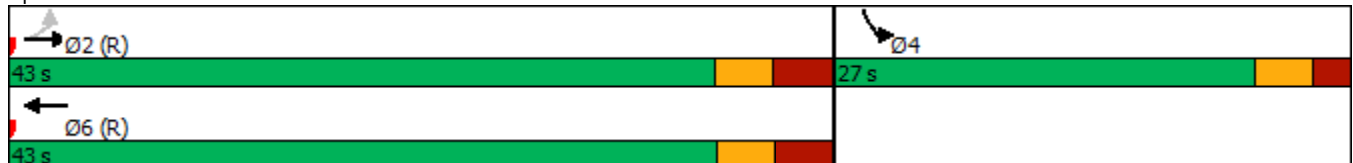

Lanes, Volumes, Timings

11: Raleigh Street/Hillsborough Street & E. Franklin Street

09/01/2020



Lane Group	EBL	EBT	EBR	WBL	WBT	WBR	NBL	NBT	NBR	SBL	SBT	SBR
Lane Configurations												
Traffic Volume (vph)	51	555	239	62	663	242	52	199	23	70	208	13
Future Volume (vph)	51	555	239	62	663	242	52	199	23	70	208	13
Ideal Flow (vphpl)	1900	1900	1900	1900	1900	1900	1900	1900	1900	1900	1900	1900
Lane Width (ft)	9	9	10	9	10	11	12	12	12	10	10	10
Grade (%)		1%			-2%			1%			1%	
Storage Length (ft)	75		0	75		0	0		0	100		0
Storage Lanes	1		0	1		0	0		0	1		0
Taper Length (ft)	25			25			25			25		
Lane Util. Factor	1.00	0.95	0.95	1.00	0.95	0.95	1.00	1.00	1.00	1.00	1.00	1.00
Ped Bike Factor	1.00	0.99		1.00	0.99			0.99		0.99	0.99	
Frt		0.955			0.960			0.989			0.991	
Flt Protected	0.950			0.950				0.991		0.950		
Satd. Flow (prot)	1585	2995	0	1609	3173	0	0	1813	0	1643	1702	0
Flt Permitted	0.248			0.286				0.695		0.407		
Satd. Flow (perm)	412	2995	0	482	3173	0	0	1259	0	700	1702	0
Right Turn on Red			No			No			No			No
Satd. Flow (RTOR)												
Link Speed (mph)		20			30			25			25	
Link Distance (ft)		1200			1013			995			363	
Travel Time (s)		40.9			23.0			27.1			9.9	
Confl. Peds. (#/hr)	16		16	16		16	58		7	7		58
Peak Hour Factor	0.91	0.91	0.91	0.92	0.92	0.92	0.93	0.93	0.93	0.88	0.88	0.88
Adj. Flow (vph)	56	610	263	67	721	263	56	214	25	80	236	15
Shared Lane Traffic (%)												
Lane Group Flow (vph)	56	873	0	67	984	0	0	295	0	80	251	0
Turn Type	Perm	NA		Perm	NA		pm+pt	NA		D.Pm	NA	
Protected Phases		2			6		7	4			8	
Permitted Phases	2			6			4			4		
Detector Phase	2	2		6	6		7	4		4	8	
Switch Phase												
Minimum Initial (s)	10.0	10.0		10.0	10.0		7.0	7.0		7.0	7.0	
Minimum Split (s)	16.0	16.0		16.0	16.0		14.0	30.0		30.0	29.0	
Total Split (s)	79.0	79.0		79.0	79.0		14.0	61.0		61.0	47.0	
Total Split (%)	56.4%	56.4%		56.4%	56.4%		10.0%	43.6%		43.6%	33.6%	
Maximum Green (s)	73.7	73.7		73.7	73.7		7.8	54.6		54.6	40.6	
Yellow Time (s)	3.0	3.0		3.0	3.0		3.0	3.1		3.1	3.1	
All-Red Time (s)	2.3	2.3		2.3	2.3		3.2	3.3		3.3	3.3	
Lost Time Adjust (s)	-0.3	-0.3		-0.3	-0.3			-1.4		-1.4	-1.4	
Total Lost Time (s)	5.0	5.0		5.0	5.0			5.0		5.0	5.0	
Lead/Lag							Lead				Lag	
Lead-Lag Optimize?												
Vehicle Extension (s)	3.0	3.0		3.0	3.0		3.0	2.0		2.0	2.0	
Recall Mode	C-Max	C-Max		C-Max	C-Max		None	None		None	None	
Walk Time (s)								7.0		7.0	7.0	
Flash Dont Walk (s)								16.0		16.0	15.0	
Pedestrian Calls (#/hr)								0		0	0	
Act Effect Green (s)	93.1	93.1		93.1	93.1			36.9		36.9	36.9	
Actuated g/C Ratio	0.66	0.66		0.66	0.66			0.26		0.26	0.26	

Lanes, Volumes, Timings

11: Raleigh Street/Hillsborough Street & E. Franklin Street

09/01/2020



Lane Group	EBL	EBT	EBR	WBL	WBT	WBR	NBL	NBT	NBR	SBL	SBT	SBR
v/c Ratio	0.20	0.44		0.21	0.47			0.89		0.43	0.56	
Control Delay	6.4	5.3		13.4	13.4			76.9		43.6	43.4	
Queue Delay	0.0	0.0		0.0	0.0			0.0		0.0	1.1	
Total Delay	6.4	5.3		13.4	13.4			76.9		43.6	44.5	
LOS	A	A		B	B			E		D	D	
Approach Delay		5.4			13.4			76.9			44.3	
Approach LOS		A			B			E			D	
Queue Length 50th (ft)	8	73		22	213			260		58	181	
Queue Length 95th (ft)	m20	146		59	332			341		90	225	
Internal Link Dist (ft)		1120			933			915			283	
Turn Bay Length (ft)	75			75						100		
Base Capacity (vph)	274	1992		320	2110			503		280	526	
Starvation Cap Reductn	0	0		0	0			0		0	116	
Spillback Cap Reductn	0	0		0	0			0		0	0	
Storage Cap Reductn	0	0		0	0			0		0	0	
Reduced v/c Ratio	0.20	0.44		0.21	0.47			0.59		0.29	0.61	

Intersection Summary

Area Type: Other
 Cycle Length: 140
 Actuated Cycle Length: 140
 Offset: 73 (52%), Referenced to phase 2:EBTL and 6:WBTL, Start of Green
 Natural Cycle: 70
 Control Type: Actuated-Coordinated
 Maximum v/c Ratio: 0.89
 Intersection Signal Delay: 21.6
 Intersection LOS: C
 Intersection Capacity Utilization 84.6%
 ICU Level of Service E
 Analysis Period (min) 15
 m Volume for 95th percentile queue is metered by upstream signal.

Splits and Phases: 11: Raleigh Street/Hillsborough Street & E. Franklin Street

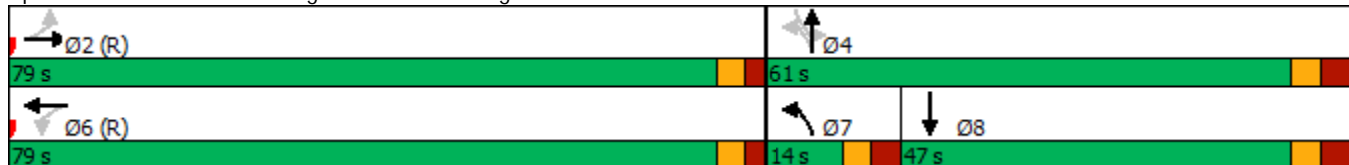

Lanes, Volumes, Timings

14: NC 86 (MLK Jr. Blvd) & Longview Street/Mill Creek Apts Driveway

09/01/2020



Lane Group	EBL	EBT	EBR	WBL	WBT	WBR	NBL	NBT	NBR	SBL	SBT	SBR
Lane Configurations		↕			↕		↕	↕↔		↕	↕↔	
Traffic Volume (vph)	96	2	18	34	1	8	14	854	13	11	646	77
Future Volume (vph)	96	2	18	34	1	8	14	854	13	11	646	77
Ideal Flow (vphpl)	1900	1900	1900	1900	1900	1900	1900	1900	1900	1900	1900	1900
Grade (%)		-6%			1%			2%			-4%	
Storage Length (ft)	0		0	0		0	225		0	250		0
Storage Lanes	0		0	0		0	1		0	1		0
Taper Length (ft)	25			25			25			25		
Lane Util. Factor	1.00	1.00	1.00	1.00	1.00	1.00	1.00	0.95	0.95	1.00	0.95	0.95
Ped Bike Factor		0.99			0.99		0.99	1.00		0.99	1.00	
Frt		0.979			0.974			0.998			0.984	
Flt Protected		0.960			0.962		0.950			0.950		
Satd. Flow (prot)	0	1794	0	0	1732	0	1735	3458	0	1787	3504	0
Flt Permitted		0.723			0.751		0.349			0.251		
Satd. Flow (perm)	0	1349	0	0	1335	0	634	3458	0	466	3504	0
Right Turn on Red			No			No			No			No
Satd. Flow (RTOR)												
Link Speed (mph)		25			20			35			35	
Link Distance (ft)		451			338			2108			784	
Travel Time (s)		12.3			11.5			41.1			15.3	
Confl. Peds. (#/hr)	2		20	20		2	7		28	28		7
Peak Hour Factor	0.89	0.89	0.89	0.75	0.75	0.75	0.86	0.86	0.86	0.93	0.93	0.93
Heavy Vehicles (%)	2%	2%	2%	2%	2%	2%	3%	3%	3%	3%	3%	3%
Adj. Flow (vph)	108	2	20	45	1	11	16	993	15	12	695	83
Shared Lane Traffic (%)												
Lane Group Flow (vph)	0	130	0	0	57	0	16	1008	0	12	778	0
Turn Type	Perm	NA		Perm	NA		Perm	NA		Perm	NA	
Protected Phases		4			8			2			6	
Permitted Phases	4			8			2			6		
Detector Phase	4	4		8	8		2	2		6	6	
Switch Phase												
Minimum Initial (s)	7.0	7.0		7.0	7.0		12.0	12.0		12.0	12.0	
Minimum Split (s)	31.0	31.0		14.0	14.0		28.0	28.0		28.0	28.0	
Total Split (s)	20.0	20.0		20.0	20.0		60.0	60.0		60.0	60.0	
Total Split (%)	25.0%	25.0%		25.0%	25.0%		75.0%	75.0%		75.0%	75.0%	
Maximum Green (s)	14.0	14.0		13.9	13.9		54.0	54.0		54.5	54.5	
Yellow Time (s)	3.5	3.5		3.0	3.0		4.5	4.5		4.0	4.0	
All-Red Time (s)	2.5	2.5		3.1	3.1		1.5	1.5		1.5	1.5	
Lost Time Adjust (s)		-1.0			-1.0		-1.0	-1.0		-0.5	-0.5	
Total Lost Time (s)		5.0			5.1		5.0	5.0		5.0	5.0	
Lead/Lag												
Lead-Lag Optimize?												
Vehicle Extension (s)	3.0	3.0		3.0	3.0		3.0	3.0		3.0	3.0	
Recall Mode	None	None		None	None		Min	Min		Min	Min	
Walk Time (s)	7.0	7.0					7.0	7.0		7.0	7.0	
Flash Dont Walk (s)	17.0	17.0					9.0	9.0		9.0	9.0	
Pedestrian Calls (#/hr)	0	0					0	0		0	0	
Act Effct Green (s)		10.7			10.6		26.4	26.4		26.4	26.4	
Actuated g/C Ratio		0.25			0.25		0.62	0.62		0.62	0.62	

Lanes, Volumes, Timings

14: NC 86 (MLK Jr. Blvd) & Longview Street/Mill Creek Apts Driveway

09/01/2020



Lane Group	EBL	EBT	EBR	WBL	WBT	WBR	NBL	NBT	NBR	SBL	SBT	SBR
v/c Ratio		0.39			0.17		0.04	0.47		0.04	0.36	
Control Delay		18.7			15.7		6.0	7.5		6.1	6.6	
Queue Delay		0.0			0.0		0.0	0.0		0.0	0.0	
Total Delay		18.7			15.7		6.0	7.5		6.1	6.6	
LOS		B			B		A	A		A	A	
Approach Delay		18.7			15.7			7.5			6.6	
Approach LOS		B			B			A			A	
Queue Length 50th (ft)		26			11		2	74		1	52	
Queue Length 95th (ft)		73			31		9	132		8	102	
Internal Link Dist (ft)		371			258			2028			704	
Turn Bay Length (ft)							225			250		
Base Capacity (vph)		487			479		633	3455		466	3501	
Starvation Cap Reductn		0			0		0	0		0	0	
Spillback Cap Reductn		0			0		0	0		0	0	
Storage Cap Reductn		0			0		0	0		0	0	
Reduced v/c Ratio		0.27			0.12		0.03	0.29		0.03	0.22	

Intersection Summary

Area Type:	Other
Cycle Length:	80
Actuated Cycle Length:	42.8
Natural Cycle:	60
Control Type:	Actuated-Uncoordinated
Maximum v/c Ratio:	0.47
Intersection Signal Delay:	8.1
Intersection LOS:	A
Intersection Capacity Utilization:	46.0%
ICU Level of Service:	A
Analysis Period (min):	15

Splits and Phases: 14: NC 86 (MLK Jr. Blvd) & Longview Street/Mill Creek Apts Driveway



Lanes, Volumes, Timings
 15: NC 86 (Pittsboro St) & W. Cameron Avenue

09/01/2020



Lane Group	EBT	EBR	WBL	WBT	NBL	NBR	Ø1	Ø4
Lane Configurations	↻		↻↻	↻				
Traffic Volume (vph)	147	220	511	356	0	0		
Future Volume (vph)	147	220	511	356	0	0		
Ideal Flow (vphpl)	1900	1900	1900	1900	1900	1900		
Lane Width (ft)	12	12	11	12	12	12		
Grade (%)	3%			-3%	0%			
Storage Length (ft)		0	75		0	0		
Storage Lanes		0	0		0	0		
Taper Length (ft)			25		25			
Lane Util. Factor	1.00	1.00	0.97	1.00	1.00	1.00		
Ped Bike Factor	0.84		0.74					
Frt	0.919							
Flt Protected			0.950					
Satd. Flow (prot)	1268	0	2890	1622	0	0		
Flt Permitted			0.950					
Satd. Flow (perm)	1268	0	2146	1622	0	0		
Right Turn on Red		No				No		
Satd. Flow (RTOR)								
Link Speed (mph)	25			25	25			
Link Distance (ft)	391			120	794			
Travel Time (s)	30.0			10.7	21.7			
Confl. Peds. (#/hr)		70	70					
Peak Hour Factor	0.93	0.93	0.96	0.96	0.90	0.90		
Heavy Vehicles (%)	2%	2%	7%	7%	2%	2%		
Adj. Flow (vph)	158	237	532	371	0	0		
Shared Lane Traffic (%)								
Lane Group Flow (vph)	395	0	532	371	0	0		
Turn Type	NA		Prot	NA				
Protected Phases	2		1 4	6			1	4
Permitted Phases								
Detector Phase	2		1 4	6				
Switch Phase								
Minimum Initial (s)	10.0			10.0			7.0	7.0
Minimum Split (s)	20.1			20.0			20.0	21.0
Total Split (s)	44.0			102.0			58.0	38.0
Total Split (%)	31.4%			72.9%			41%	27%
Maximum Green (s)	38.9			97.0			52.9	34.0
Yellow Time (s)	3.0			3.3			3.0	3.0
All-Red Time (s)	2.1			1.7			2.1	1.0
Lost Time Adjust (s)	-0.1			0.0				
Total Lost Time (s)	5.0			5.0				
Lead/Lag	Lead						Lag	
Lead-Lag Optimize?								
Vehicle Extension (s)	1.0			1.0			4.0	0.2
Recall Mode	None			C-Max			C-Max	None
Walk Time (s)	7.0							7.0
Flash Dont Walk (s)	4.0							9.0
Pedestrian Calls (#/hr)	0							0
Act Effect Green (s)	56.8		73.2	124.0				

Lanes, Volumes, Timings
 15: NC 86 (Pittsboro St) & W. Cameron Avenue

09/01/2020



Lane Group	EBT	EBR	WBL	WBT	NBL	NBR	Ø1	Ø4
Actuated g/C Ratio	0.41		0.52	0.89				
v/c Ratio	0.77		0.35	0.26				
Control Delay	48.3		14.4	0.7				
Queue Delay	0.0		0.1	0.7				
Total Delay	48.3		14.5	1.4				
LOS	D		B	A				
Approach Delay	48.3			9.1				
Approach LOS	D			A				
Queue Length 50th (ft)	322		78	3				
Queue Length 95th (ft)	446		m110	m23				
Internal Link Dist (ft)	311			40	714			
Turn Bay Length (ft)			75					
Base Capacity (vph)	514		2067	1436				
Starvation Cap Reductn	0		551	727				
Spillback Cap Reductn	0		0	0				
Storage Cap Reductn	0		0	0				
Reduced v/c Ratio	0.77		0.35	0.52				

Intersection Summary

Area Type: CBD
 Cycle Length: 140
 Actuated Cycle Length: 140
 Offset: 104 (74%), Referenced to phase 1:WBL and 6:WBT, Start of Green
 Natural Cycle: 70
 Control Type: Actuated-Coordinated
 Maximum v/c Ratio: 0.77
 Intersection Signal Delay: 21.0 Intersection LOS: C
 Intersection Capacity Utilization 51.1% ICU Level of Service A
 Analysis Period (min) 15
 m Volume for 95th percentile queue is metered by upstream signal.

Splits and Phases: 15: NC 86 (Pittsboro St) & W. Cameron Avenue



Lanes, Volumes, Timings

16: NC 86 (S. Columbia St) & W. Cameron Avenue/E. Cameron Avenue

09/01/2020



Lane Group	EBL	EBT	EBR	WBL	WBT	WBR	NBL	NBT	NBR	SBL	SBT	SBR
Lane Configurations												
Traffic Volume (vph)	19	122	0	0	166	51	220	653	59	119	0	469
Future Volume (vph)	19	122	0	0	166	51	220	653	59	119	0	469
Ideal Flow (vphpl)	1900	1900	1900	1900	1900	1900	1900	1900	1900	1900	1900	1900
Lane Width (ft)	11	12	12	12	12	12	10	10	10	11	11	12
Grade (%)		1%			-1%			1%			2%	
Storage Length (ft)	100		0	0		0	0		0	310		0
Storage Lanes	1		0	0		0	1		0	1		2
Taper Length (ft)	25			25			25			25		
Lane Util. Factor	1.00	1.00	1.00	1.00	1.00	1.00	0.91	0.91	0.95	1.00	1.00	0.88
Ped Bike Factor	0.86				0.93		0.68	0.94		0.79		0.60
Frt					0.968			0.988				0.850
Flt Protected	0.950						0.950	0.999		0.950		
Satd. Flow (prot)	1532	1668	0	0	1493	0	1295	2540	0	1453	0	2367
Flt Permitted	0.298						0.950	0.999		0.950		
Satd. Flow (perm)	411	1668	0	0	1493	0	884	2516	0	1143	0	1418
Right Turn on Red			No			No			No			No
Satd. Flow (RTOR)												
Link Speed (mph)		25			25			25				25
Link Distance (ft)		273			989			826				981
Travel Time (s)		10.7			57.6			22.5				26.8
Confl. Peds. (#/hr)	157		172	172		157	111		248	248		111
Peak Hour Factor	0.91	0.91	0.91	0.90	0.90	0.90	0.87	0.87	0.87	0.85	0.85	0.85
Heavy Vehicles (%)	2%	2%	2%	4%	4%	4%	6%	6%	6%	7%	7%	7%
Adj. Flow (vph)	21	134	0	0	184	57	253	751	68	140	0	552
Shared Lane Traffic (%)							10%					
Lane Group Flow (vph)	21	134	0	0	241	0	228	844	0	140	0	552
Turn Type	Perm	NA			NA		Split	NA		Prot		Prot
Protected Phases		4			8		2	2		1		1
Permitted Phases	4									1		1
Detector Phase	4	4			8		2	2		1		1
Switch Phase												
Minimum Initial (s)	10.0	10.0			10.0		7.0	7.0		7.0		7.0
Minimum Split (s)	24.0	24.0			31.0		18.0	18.0		26.0		26.0
Total Split (s)	31.0	31.0			31.0		47.0	47.0		34.0		34.0
Total Split (%)	22.1%	22.1%			22.1%		33.6%	33.6%		24.3%		24.3%
Maximum Green (s)	24.8	24.8			24.8		41.1	41.1		28.4		28.4
Yellow Time (s)	3.2	3.2			3.2		3.1	3.1		3.0		3.0
All-Red Time (s)	3.0	3.0			3.0		2.8	2.8		2.6		2.6
Lost Time Adjust (s)	-1.2	-1.2			-1.2		-0.9	-0.9		-0.6		-0.6
Total Lost Time (s)	5.0	5.0			5.0		5.0	5.0		5.0		5.0
Lead/Lag							Lag	Lag		Lead		Lead
Lead-Lag Optimize?												
Vehicle Extension (s)	2.0	2.0			2.0		4.0	4.0		4.0		4.0
Recall Mode	None	None			None		C-Max	C-Max		None		None
Walk Time (s)	7.0	7.0			7.0		7.0	7.0		7.0		7.0
Flash Dont Walk (s)	10.0	10.0			17.0		5.0	5.0		13.0		13.0
Pedestrian Calls (#/hr)	0	0			0		0	0		0		0
Act Effect Green (s)	25.0	25.0			25.0		52.3	52.3		47.7		47.7

Lanes, Volumes, Timings

16: NC 86 (S. Columbia St) & W. Cameron Avenue/E. Cameron Avenue

09/01/2020

Lane Group	Ø9
Lane Configurations	
Traffic Volume (vph)	
Future Volume (vph)	
Ideal Flow (vphpl)	
Lane Width (ft)	
Grade (%)	
Storage Length (ft)	
Storage Lanes	
Taper Length (ft)	
Lane Util. Factor	
Ped Bike Factor	
Frt	
Flt Protected	
Satd. Flow (prot)	
Flt Permitted	
Satd. Flow (perm)	
Right Turn on Red	
Satd. Flow (RTOR)	
Link Speed (mph)	
Link Distance (ft)	
Travel Time (s)	
Confl. Peds. (#/hr)	
Peak Hour Factor	
Heavy Vehicles (%)	
Adj. Flow (vph)	
Shared Lane Traffic (%)	
Lane Group Flow (vph)	
Turn Type	
Protected Phases	9
Permitted Phases	
Detector Phase	
Switch Phase	
Minimum Initial (s)	7.0
Minimum Split (s)	28.0
Total Split (s)	28.0
Total Split (%)	20%
Maximum Green (s)	24.0
Yellow Time (s)	3.0
All-Red Time (s)	1.0
Lost Time Adjust (s)	
Total Lost Time (s)	
Lead/Lag	
Lead-Lag Optimize?	
Vehicle Extension (s)	0.2
Recall Mode	None
Walk Time (s)	7.0
Flash Dont Walk (s)	17.0
Pedestrian Calls (#/hr)	0
Act Effect Green (s)	

Lanes, Volumes, Timings

16: NC 86 (S. Columbia St) & W. Cameron Avenue/E. Cameron Avenue

09/01/2020



Lane Group	EBL	EBT	EBR	WBL	WBT	WBR	NBL	NBT	NBR	SBL	SBT	SBR
Actuated g/C Ratio	0.18	0.18			0.18		0.37	0.37		0.34		0.34
v/c Ratio	0.29	0.45			0.91		0.47	0.89		0.28		0.68
Control Delay	23.2	20.4			91.7		37.3	53.6		20.4		29.4
Queue Delay	0.0	0.0			0.0		0.0	0.0		0.0		0.0
Total Delay	23.2	20.4			91.7		37.3	53.6		20.4		29.4
LOS	C	C			F		D	D		C		C
Approach Delay		20.7			91.7			50.2				27.6
Approach LOS		C			F			D				C
Queue Length 50th (ft)	10	74			216		169	387		83		243
Queue Length 95th (ft)	m14	m102			#367		254	#484		m111		293
Internal Link Dist (ft)		193			909			746				901
Turn Bay Length (ft)	100									310		
Base Capacity (vph)	76	309			277		483	949		495		806
Starvation Cap Reductn	0	0			0		0	0		0		0
Spillback Cap Reductn	0	0			0		0	0		0		0
Storage Cap Reductn	0	0			0		0	0		0		0
Reduced v/c Ratio	0.28	0.43			0.87		0.47	0.89		0.28		0.68

Intersection Summary

Area Type: CBD
 Cycle Length: 140
 Actuated Cycle Length: 140
 Offset: 23 (16%), Referenced to phase 2:NBTL, Start of Green
 Natural Cycle: 145
 Control Type: Actuated-Coordinated
 Maximum v/c Ratio: 0.91
 Intersection Signal Delay: 45.5 Intersection LOS: D
 Intersection Capacity Utilization 77.8% ICU Level of Service D
 Analysis Period (min) 15
 # 95th percentile volume exceeds capacity, queue may be longer.
 Queue shown is maximum after two cycles.
 m Volume for 95th percentile queue is metered by upstream signal.

Splits and Phases: 16: NC 86 (S. Columbia St) & W. Cameron Avenue/E. Cameron Avenue

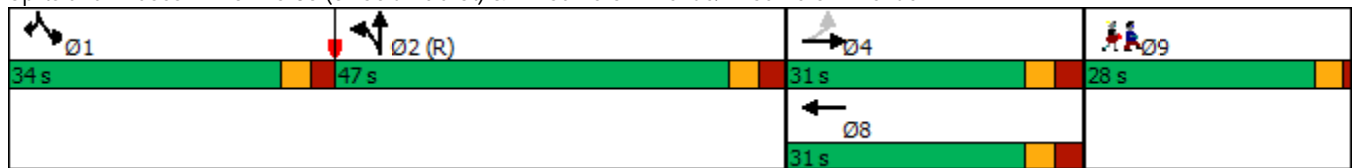

Lanes, Volumes, Timings

16: NC 86 (S. Columbia St) & W. Cameron Avenue/E. Cameron Avenue

09/01/2020

Lane Group	Ø9
Actuated g/C Ratio	
v/c Ratio	
Control Delay	
Queue Delay	
Total Delay	
LOS	
Approach Delay	
Approach LOS	
Queue Length 50th (ft)	
Queue Length 95th (ft)	
Internal Link Dist (ft)	
Turn Bay Length (ft)	
Base Capacity (vph)	
Starvation Cap Reductn	
Spillback Cap Reductn	
Storage Cap Reductn	
Reduced v/c Ratio	
Intersection Summary	

Lanes, Volumes, Timings

17: Raleigh Street & E. Cameron Avenue/Country Club Road

09/01/2020



Lane Group	EBL	EBT	EBR	WBL	WBT	WBR	NBL	NBT	NBR	SBL	SBT	SBR
Lane Configurations		↕		↗	↘		↗	↘		↗	↘	
Traffic Volume (vph)	27	162	47	35	129	182	55	92	61	277	186	53
Future Volume (vph)	27	162	47	35	129	182	55	92	61	277	186	53
Ideal Flow (vphpl)	1900	1900	1900	1900	1900	1900	1900	1900	1900	1900	1900	1900
Grade (%)		-3%			3%			-2%				1%
Storage Length (ft)	0		0	150		0	125		0	75		0
Storage Lanes	0		0	1		0	1		0	1		0
Taper Length (ft)	25			25			25			25		
Lane Util. Factor	1.00	1.00	1.00	1.00	1.00	1.00	1.00	1.00	1.00	1.00	1.00	1.00
Ped Bike Factor		0.94			0.88			0.88		0.82	0.88	
Frt		0.973			0.912			0.940			0.967	
Flt Protected		0.994		0.950			0.950			0.950		
Satd. Flow (prot)	0	1571	0	1569	1327	0	1563	1358	0	1585	1419	0
Flt Permitted		0.924		0.372			0.586			0.447		
Satd. Flow (perm)	0	1441	0	614	1327	0	964	1358	0	609	1419	0
Right Turn on Red			No			No			No			No
Satd. Flow (RTOR)												
Link Speed (mph)		25			25			25				25
Link Distance (ft)		598			651			409				995
Travel Time (s)		16.3			17.8			11.2				27.1
Confl. Peds. (#/hr)	39		37	37		39	107		60	60		107
Peak Hour Factor	0.75	0.75	0.75	0.89	0.89	0.89	0.89	0.89	0.89	0.84	0.84	0.84
Heavy Vehicles (%)	2%	2%	2%	2%	2%	2%	5%	5%	5%	2%	2%	2%
Adj. Flow (vph)	36	216	63	39	145	204	62	103	69	330	221	63
Shared Lane Traffic (%)												
Lane Group Flow (vph)	0	315	0	39	349	0	62	172	0	330	284	0
Turn Type	Perm	NA		pm+pt	NA		pm+pt	NA		pm+pt	NA	
Protected Phases		2		1	6		3	8		7	4	
Permitted Phases	2			6			8			4		
Detector Phase	2	2		1	6		3	8		7	4	
Switch Phase												
Minimum Initial (s)	10.0	10.0		7.0	10.0		7.0	7.0		7.0	7.0	
Minimum Split (s)	18.0	18.0		13.0	19.0		13.0	19.0		12.0	16.0	
Total Split (s)	50.0	50.0		20.0	70.0		20.0	35.0		20.0	35.0	
Total Split (%)	40.0%	40.0%		16.0%	56.0%		16.0%	28.0%		16.0%	28.0%	
Maximum Green (s)	43.9	43.9		14.4	64.4		14.7	29.7		15.1	29.9	
Yellow Time (s)	3.3	3.3		3.0	3.1		3.0	3.1		3.0	3.1	
All-Red Time (s)	2.8	2.8		2.6	2.5		2.3	2.2		1.9	2.0	
Lost Time Adjust (s)		-1.1		-0.6	-0.6		-0.3	-0.3		0.1	-0.1	
Total Lost Time (s)		5.0		5.0	5.0		5.0	5.0		5.0	5.0	
Lead/Lag	Lag	Lag		Lead			Lead	Lag		Lead	Lag	
Lead-Lag Optimize?	Yes	Yes		Yes			Yes	Yes		Yes	Yes	
Vehicle Extension (s)	2.0	2.0		2.0	2.0		2.0	2.0		2.0	2.0	
Recall Mode	None	None		None	None		None	None		None	None	
Walk Time (s)	4.0	4.0			4.0			4.0			4.0	
Flash Dont Walk (s)	7.0	7.0			9.0			9.0			6.0	
Pedestrian Calls (#/hr)	0	0			0			0			0	
Act Effect Green (s)		24.5		31.0	31.0		23.9	15.6		37.0	27.1	
Actuated g/C Ratio		0.31		0.39	0.39		0.30	0.20		0.47	0.34	

Lanes, Volumes, Timings

17: Raleigh Street & E. Cameron Avenue/Country Club Road

09/01/2020



Lane Group	EBL	EBT	EBR	WBL	WBT	WBR	NBL	NBT	NBR	SBL	SBT	SBR
v/c Ratio		0.70		0.11	0.67		0.17	0.64		0.68	0.58	
Control Delay		35.2		15.2	26.1		17.7	43.5		26.9	32.7	
Queue Delay		0.0		0.0	0.0		0.0	0.0		0.0	0.0	
Total Delay		35.2		15.2	26.1		17.7	43.5		26.9	32.7	
LOS		D		B	C		B	D		C	C	
Approach Delay		35.2			25.0			36.7			29.6	
Approach LOS		D			C			D			C	
Queue Length 50th (ft)		146		11	130		19	84		120	132	
Queue Length 95th (ft)		213		32	251		51	172		#247	248	
Internal Link Dist (ft)		518			571			329			915	
Turn Bay Length (ft)				150			125			75		
Base Capacity (vph)		888		442	1086		512	558		486	586	
Starvation Cap Reductn		0		0	0		0	0		0	0	
Spillback Cap Reductn		0		0	0		0	0		0	0	
Storage Cap Reductn		0		0	0		0	0		0	0	
Reduced v/c Ratio		0.35		0.09	0.32		0.12	0.31		0.68	0.48	

Intersection Summary

Area Type: CBD
 Cycle Length: 125
 Actuated Cycle Length: 78.8
 Natural Cycle: 70
 Control Type: Actuated-Uncoordinated
 Maximum v/c Ratio: 0.70
 Intersection Signal Delay: 30.7
 Intersection LOS: C
 Intersection Capacity Utilization 80.1%
 ICU Level of Service D
 Analysis Period (min) 15
 # 95th percentile volume exceeds capacity, queue may be longer.
 Queue shown is maximum after two cycles.

Splits and Phases: 17: Raleigh Street & E. Cameron Avenue/Country Club Road

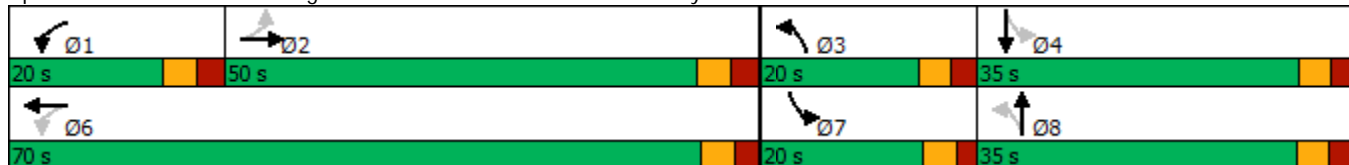



2022 With Parking Deck – Current Site Plan

Lanes, Volumes, Timings
1: Church Street & W. Rosemary Street

2022 Build Alternative 1 AM Peak

Timing Plan: AM Peak



Lane Group	EBL	EBT	EBR	WBL	WBT	WBR	NBL	NBT	NBR	SBL	SBT	SBR
Lane Configurations		↕			↕			↕			↕	
Traffic Volume (vph)	14	288	21	32	301	15	33	24	40	27	39	11
Future Volume (vph)	14	288	21	32	301	15	33	24	40	27	39	11
Ideal Flow (vphpl)	1900	1900	1900	1900	1900	1900	1900	1900	1900	1900	1900	1900
Lane Width (ft)	12	14	12	12	14	12	12	12	12	12	12	12
Grade (%)		1%			-1%			0%			0%	
Lane Util. Factor	1.00	1.00	1.00	1.00	1.00	1.00	1.00	1.00	1.00	1.00	1.00	1.00
Ped Bike Factor		0.99			0.99			0.95			0.97	
Frt		0.991			0.994			0.944			0.981	
Flt Protected		0.998			0.995			0.983			0.983	
Satd. Flow (prot)	0	1734	0	0	1737	0	0	1501	0	0	1602	0
Flt Permitted		0.982			0.950			0.884			0.873	
Satd. Flow (perm)	0	1704	0	0	1655	0	0	1332	0	0	1395	0
Right Turn on Red			No			No			No			No
Satd. Flow (RTOR)												
Link Speed (mph)		20			20			25			25	
Link Distance (ft)		964			757			379			430	
Travel Time (s)		32.9			25.8			10.3			11.7	
Confl. Peds. (#/hr)	20		17	17		20	21		31	31		21
Peak Hour Factor	0.86	0.86	0.86	0.89	0.89	0.89	0.84	0.84	0.84	0.72	0.72	0.72
Heavy Vehicles (%)	3%	3%	3%	4%	4%	4%	2%	2%	2%	2%	2%	2%
Adj. Flow (vph)	16	335	24	36	338	17	39	29	48	38	54	15
Shared Lane Traffic (%)												
Lane Group Flow (vph)	0	375	0	0	391	0	0	116	0	0	107	0
Turn Type	Perm	NA		Perm	NA		Perm	NA		Perm	NA	
Protected Phases		2			6			8			4	
Permitted Phases	2			6			8		4			
Detector Phase	2	2		6	6		8	8		4	4	
Switch Phase												
Minimum Initial (s)	10.0	10.0		10.0	10.0		7.0	7.0		7.0	7.0	
Minimum Split (s)	19.0	19.0		20.0	20.0		19.0	19.0		19.0	19.0	
Total Split (s)	38.0	38.0		38.0	38.0		22.0	22.0		22.0	22.0	
Total Split (%)	63.3%	63.3%		63.3%	63.3%		36.7%	36.7%		36.7%	36.7%	
Maximum Green (s)	33.5	33.5		33.4	33.4		17.1	17.1		17.1	17.1	
Yellow Time (s)	3.1	3.1		3.1	3.1		3.2	3.2		3.2	3.2	
All-Red Time (s)	1.4	1.4		1.5	1.5		1.7	1.7		1.7	1.7	
Lost Time Adjust (s)		0.5			0.4			0.1			0.1	
Total Lost Time (s)		5.0			5.0			5.0			5.0	
Lead/Lag												
Lead-Lag Optimize?												
Vehicle Extension (s)	3.0	3.0		3.0	3.0		3.0	3.0		3.0	3.0	
Recall Mode	C-Max	C-Max		C-Max	C-Max		None	None		None	None	
Walk Time (s)	4.0	4.0		4.0	4.0		4.0	4.0		4.0	4.0	
Flash Dont Walk (s)	5.0	5.0		6.0	6.0		10.0	10.0		10.0	10.0	
Pedestrian Calls (#/hr)	0	0		0	0		0	0		0	0	
Act Effct Green (s)		42.8			42.8			10.6			10.6	
Actuated g/C Ratio		0.71			0.71			0.18			0.18	
v/c Ratio		0.31			0.33			0.49			0.43	
Control Delay		5.8			3.4			24.8			26.6	

Lanes, Volumes, Timings
 1: Church Street & W. Rosemary Street

2022 Build Alternative 1 AM Peak
 Timing Plan: AM Peak



Lane Group	EBL	EBT	EBR	WBL	WBT	WBR	NBL	NBT	NBR	SBL	SBT	SBR
Queue Delay		0.0			0.0			0.0			0.0	
Total Delay		5.8			3.4			24.8			26.6	
LOS		A			A			C			C	
Approach Delay		5.8			3.4			24.8			26.6	
Approach LOS		A			A			C			C	
Queue Length 50th (ft)		48			18			38			35	
Queue Length 95th (ft)		103			48			54			53	
Internal Link Dist (ft)		884			677			299			350	
Turn Bay Length (ft)												
Base Capacity (vph)		1214			1179			377			395	
Starvation Cap Reductn		0			0			0			0	
Spillback Cap Reductn		0			0			0			0	
Storage Cap Reductn		0			0			0			0	
Reduced v/c Ratio		0.31			0.33			0.31			0.27	

Intersection Summary

Area Type:	CBD
Cycle Length:	60
Actuated Cycle Length:	60
Offset:	7 (12%), Referenced to phase 2:EBTL and 6:WBTL, Start of Green
Natural Cycle:	40
Control Type:	Actuated-Coordinated
Maximum v/c Ratio:	0.49
Intersection Signal Delay:	9.3
Intersection LOS:	A
Intersection Capacity Utilization:	51.4%
ICU Level of Service:	A
Analysis Period (min):	15

Splits and Phases: 1: Church Street & W. Rosemary Street

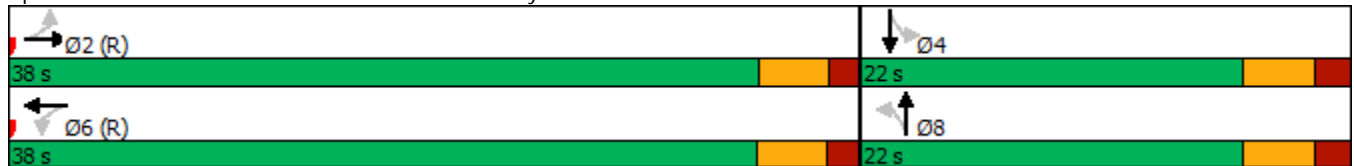

Lanes, Volumes, Timings

2022 Build Alternative 1 AM Peak

2: NC 86 (N. Columbia St) & W. Rosemary Street/E. Rosemary Street

Timing Plan: AM Peak

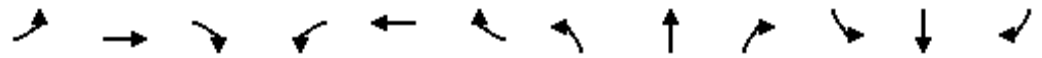

Lane Group	EBL	EBT	EBR	WBL	WBT	WBR	NBL	NBT	NBR	SBL	SBT	SBR
Lane Configurations												
Traffic Volume (vph)	150	210	21	16	167	34	22	309	80	115	559	176
Future Volume (vph)	150	210	21	16	167	34	22	309	80	115	559	176
Ideal Flow (vphpl)	1900	1900	1900	1900	1900	1900	1900	1900	1900	1900	1900	1900
Lane Width (ft)	9	12	13	12	12	12	9	10	12	12	9	11
Grade (%)		1%			1%			-2%			8%	
Storage Length (ft)	100		0	75		0	75		0	150		400
Storage Lanes	1		0	1		0	1		0	1		1
Taper Length (ft)	25			25			25			25		
Lane Util. Factor	1.00	1.00	1.00	1.00	1.00	1.00	1.00	0.95	0.95	1.00	0.95	1.00
Ped Bike Factor	0.99	1.00		0.98	1.00		0.98	0.97		0.95		0.91
Frt		0.987			0.975			0.969				0.850
Flt Protected	0.950			0.950			0.950			0.950		
Satd. Flow (prot)	1426	1641	0	1585	1619	0	1355	2646	0	1485	2673	1285
Flt Permitted	0.283			0.594			0.368			0.432		
Satd. Flow (perm)	421	1641	0	975	1619	0	515	2646	0	639	2673	1169
Right Turn on Red			No			No			No			No
Satd. Flow (RTOR)												
Link Speed (mph)		20			20			25			25	
Link Distance (ft)		757			274			353			476	
Travel Time (s)		25.8			9.3			9.6			13.0	
Confl. Peds. (#/hr)	12		16	16		12	19		34	34		19
Peak Hour Factor	0.86	0.86	0.86	0.90	0.90	0.90	0.90	0.90	0.90	0.88	0.88	0.88
Heavy Vehicles (%)	2%	2%	2%	2%	2%	2%	9%	9%	9%	5%	5%	5%
Adj. Flow (vph)	174	244	24	18	186	38	24	343	89	131	635	200
Shared Lane Traffic (%)												
Lane Group Flow (vph)	174	268	0	18	224	0	24	432	0	131	635	200
Turn Type	pm+pt	NA		Perm	NA		pm+pt	NA		pm+pt	NA	pm+ov
Protected Phases	7	4			8		5	2		1	6	7
Permitted Phases	4			8			2			6		6
Detector Phase	7	4		8	8		5	2		1	6	7
Switch Phase												
Minimum Initial (s)	7.0	7.0		7.0	7.0		7.0	10.0		7.0	10.0	7.0
Minimum Split (s)	13.0	31.0		32.0	32.0		13.0	23.0		13.0	22.0	13.0
Total Split (s)	23.0	57.0		34.0	34.0		13.0	50.0		13.0	50.0	23.0
Total Split (%)	19.2%	47.5%		28.3%	28.3%		10.8%	41.7%		10.8%	41.7%	19.2%
Maximum Green (s)	17.2	51.0		28.0	28.0		7.2	44.2		7.9	44.2	17.2
Yellow Time (s)	3.0	3.2		3.2	3.2		3.0	3.3		3.0	3.3	3.0
All-Red Time (s)	2.8	2.8		2.8	2.8		2.8	2.5		2.1	2.5	2.8
Lost Time Adjust (s)	-0.8	-1.0		-1.0	-1.0		-1.0	-0.8		-0.1	-0.8	-0.8
Total Lost Time (s)	5.0	5.0		5.0	5.0		4.8	5.0		5.0	5.0	5.0
Lead/Lag	Lead			Lag	Lag		Lead	Lag		Lead	Lag	Lead
Lead-Lag Optimize?												
Vehicle Extension (s)	1.0	1.0		1.0	1.0		1.0	3.0		1.0	3.0	1.0
Recall Mode	None	None		None	None		None	C-Max		None	C-Max	None
Walk Time (s)		7.0		7.0	7.0			7.0			7.0	
Flash Dont Walk (s)		18.0		19.0	19.0			10.0			9.0	
Pedestrian Calls (#/hr)		0		0	0			0			0	
Act Effect Green (s)	42.0	42.0		21.1	21.1		62.8	54.6		65.9	60.4	76.3

Lanes, Volumes, Timings

2022 Build Alternative 1 AM Peak

2: NC 86 (N. Columbia St) & W. Rosemary Street/E. Rosemary Street

Timing Plan: AM Peak

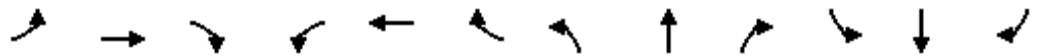

Lane Group	EBL	EBT	EBR	WBL	WBT	WBR	NBL	NBT	NBR	SBL	SBT	SBR
Actuated g/C Ratio	0.35	0.35		0.18	0.18		0.52	0.46		0.55	0.50	0.64
v/c Ratio	0.62	0.47		0.11	0.79		0.07	0.36		0.32	0.47	0.26
Control Delay	38.5	33.5		35.3	58.1		12.4	15.6		16.9	24.0	11.0
Queue Delay	0.0	0.0		0.0	0.0		0.0	0.1		0.0	0.0	0.0
Total Delay	38.5	33.5		35.3	58.1		12.4	15.7		16.9	24.0	11.0
LOS	D	C		D	E		B	B		B	C	B
Approach Delay		35.5			56.4			15.5			20.4	
Approach LOS		D			E			B			C	
Queue Length 50th (ft)	103	166		10	139		5	60		48	185	62
Queue Length 95th (ft)	141	226		30	203		m14	105		93	265	117
Internal Link Dist (ft)		677			194			273			396	
Turn Bay Length (ft)	100			75			75			150		400
Base Capacity (vph)	298	711		235	391		328	1204		412	1344	780
Starvation Cap Reductn	0	0		0	0		0	154		0	0	0
Spillback Cap Reductn	0	0		0	0		0	0		0	43	0
Storage Cap Reductn	0	0		0	0		0	0		0	0	0
Reduced v/c Ratio	0.58	0.38		0.08	0.57		0.07	0.41		0.32	0.49	0.26

Intersection Summary

Area Type: CBD
 Cycle Length: 120
 Actuated Cycle Length: 120
 Offset: 41 (34%), Referenced to phase 2:NBTL and 6:SBTL, Start of Green
 Natural Cycle: 85
 Control Type: Actuated-Coordinated
 Maximum v/c Ratio: 0.79
 Intersection Signal Delay: 26.6
 Intersection LOS: C
 Intersection Capacity Utilization 64.1%
 ICU Level of Service C
 Analysis Period (min) 15
 m Volume for 95th percentile queue is metered by upstream signal.

Splits and Phases: 2: NC 86 (N. Columbia St) & W. Rosemary Street/E. Rosemary Street

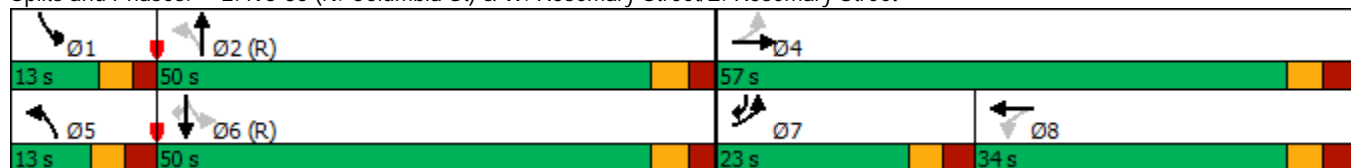

Lanes, Volumes, Timings
6: Henderson Street & E. Rosemary Street

2022 Build Alternative 1 AM Peak
Timing Plan: AM Peak



Lane Group	EBL	EBT	EBR	WBL	WBT	WBR	NBL	NBT	NBR	SBL	SBT	SBR
Lane Configurations												
Traffic Volume (vph)	5	138	62	8	238	16	58	6	8	9	16	5
Future Volume (vph)	5	138	62	8	238	16	58	6	8	9	16	5
Ideal Flow (vphpl)	1900	1900	1900	1900	1900	1900	1900	1900	1900	1900	1900	1900
Grade (%)		0%			0%			0%				3%
Storage Length (ft)	85		0	0		0	0		0	0		0
Storage Lanes	1		0	0		0	0		0	0		0
Taper Length (ft)	25			25			25			25		
Lane Util. Factor	1.00	1.00	1.00	1.00	1.00	1.00	1.00	1.00	1.00	1.00	1.00	1.00
Ped Bike Factor	0.99	0.99			1.00			0.95				0.98
Frt		0.953			0.992			0.985				0.979
Flt Protected	0.950				0.998			0.961				0.985
Satd. Flow (prot)	1593	1580	0	0	1657	0	0	1559	0	0	1559	0
Flt Permitted	0.596				0.991			0.737				0.883
Satd. Flow (perm)	993	1580	0	0	1644	0	0	1150	0	0	1378	0
Right Turn on Red			No			No			No			No
Satd. Flow (RTOR)												
Link Speed (mph)		20			20			20				20
Link Distance (ft)		496			1195			366				450
Travel Time (s)		16.9			40.7			12.5				15.3
Confl. Peds. (#/hr)	4		6	6		4	22		23	23		22
Peak Hour Factor	0.89	0.89	0.89	0.75	0.75	0.75	0.87	0.87	0.87	0.68	0.68	0.68
Heavy Vehicles (%)	2%	2%	2%	2%	2%	2%	3%	3%	3%	3%	3%	3%
Adj. Flow (vph)	6	155	70	11	317	21	67	7	9	13	24	7
Shared Lane Traffic (%)												
Lane Group Flow (vph)	6	225	0	0	349	0	0	83	0	0	44	0
Turn Type	Perm	NA		Perm	NA		Perm	NA		Perm	NA	
Protected Phases		2			2			4				4
Permitted Phases	2			2			4			4		
Detector Phase	2	2		2	2		4	4		4	4	
Switch Phase												
Minimum Initial (s)	11.0	11.0		11.0	11.0		8.0	8.0		8.0	8.0	
Minimum Split (s)	15.9	15.9		15.9	15.9		17.8	17.8		17.8	17.8	
Total Split (s)	40.0	40.0		40.0	40.0		20.0	20.0		20.0	20.0	
Total Split (%)	66.7%	66.7%		66.7%	66.7%		33.3%	33.3%		33.3%	33.3%	
Maximum Green (s)	35.1	35.1		35.1	35.1		15.2	15.2		15.2	15.2	
Yellow Time (s)	3.3	3.3		3.3	3.3		3.3	3.3		3.3	3.3	
All-Red Time (s)	1.6	1.6		1.6	1.6		1.5	1.5		1.5	1.5	
Lost Time Adjust (s)	0.1	0.1			0.1			0.2				0.2
Total Lost Time (s)	5.0	5.0			5.0			5.0				5.0
Lead/Lag												
Lead-Lag Optimize?												
Vehicle Extension (s)	2.0	2.0		2.0	2.0		2.0	2.0		2.0	2.0	
Recall Mode	C-Max	C-Max		C-Max	C-Max		None	None		None	None	
Walk Time (s)	4.0	4.0		4.0	4.0		4.0	4.0		4.0	4.0	
Flash Dont Walk (s)	7.0	7.0		7.0	7.0		9.0	9.0		9.0	9.0	
Pedestrian Calls (#/hr)	0	0		0	0		0	0		0	0	
Act Effect Green (s)	44.2	44.2			44.2			9.4				9.4
Actuated g/C Ratio	0.74	0.74			0.74			0.16				0.16

Lanes, Volumes, Timings
 6: Henderson Street & E. Rosemary Street

2022 Build Alternative 1 AM Peak
 Timing Plan: AM Peak



Lane Group	EBL	EBT	EBR	WBL	WBT	WBR	NBL	NBT	NBR	SBL	SBT	SBR
v/c Ratio	0.01	0.19			0.29			0.46			0.20	
Control Delay	6.0	5.3			5.5			27.8			23.5	
Queue Delay	0.0	0.0			0.0			0.0			0.0	
Total Delay	6.0	5.3			5.5			27.8			23.5	
LOS	A	A			A			C			C	
Approach Delay		5.3			5.5			27.8			23.5	
Approach LOS		A			A			C			C	
Queue Length 50th (ft)	1	36			70			41			14	
Queue Length 95th (ft)	m4	76			83			76			27	
Internal Link Dist (ft)		416			1115			286			370	
Turn Bay Length (ft)	85											
Base Capacity (vph)	730	1163			1210			287			344	
Starvation Cap Reductn	0	0			0			0			0	
Spillback Cap Reductn	0	0			0			0			0	
Storage Cap Reductn	0	0			0			0			0	
Reduced v/c Ratio	0.01	0.19			0.29			0.29			0.13	

Intersection Summary

Area Type: CBD
 Cycle Length: 60
 Actuated Cycle Length: 60
 Offset: 38 (63%), Referenced to phase 2:EBWB, Start of Green
 Natural Cycle: 40
 Control Type: Actuated-Coordinated
 Maximum v/c Ratio: 0.46
 Intersection Signal Delay: 9.2
 Intersection Capacity Utilization 41.3%
 Analysis Period (min) 15
 Intersection LOS: A
 ICU Level of Service A

m Volume for 95th percentile queue is metered by upstream signal.

Splits and Phases: 6: Henderson Street & E. Rosemary Street



Lanes, Volumes, Timings
7: Hillsborough Street & E. Rosemary Street

2022 Build Alternative 1 AM Peak

Timing Plan: AM Peak

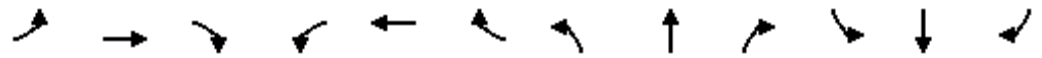

Lane Group	EBL	EBT	EBR	WBL	WBT	WBR	NBL	NBT	NBR	SBL	SBT	SBR
Lane Configurations		↕			↕		↕	↕		↕	↕	
Traffic Volume (vph)	6	57	68	0	110	12	135	142	6	21	356	32
Future Volume (vph)	6	57	68	0	110	12	135	142	6	21	356	32
Ideal Flow (vphpl)	1900	1900	1900	1900	1900	1900	1900	1900	1900	1900	1900	1900
Storage Length (ft)	0		0	0		0	100		0	100		0
Storage Lanes	0		0	0		0	1		0	1		0
Taper Length (ft)	25			25			25			25		
Lane Util. Factor	1.00	1.00	1.00	1.00	1.00	1.00	1.00	1.00	1.00	1.00	1.00	1.00
Ped Bike Factor		0.99			1.00			1.00		1.00	1.00	
Frt		0.930			0.987			0.994			0.987	
Flt Protected		0.998					0.950			0.950		
Satd. Flow (prot)	0	1706	0	0	1832	0	1752	1832	0	1752	1812	0
Flt Permitted		0.979					0.378			0.656		
Satd. Flow (perm)	0	1672	0	0	1832	0	697	1832	0	1204	1812	0
Right Turn on Red			No			No			No			No
Satd. Flow (RTOR)												
Link Speed (mph)		20			20			25			25	
Link Distance (ft)		1195			527			363			726	
Travel Time (s)		40.7			18.0			9.9			19.8	
Confl. Peds. (#/hr)	6		3	3		6	13		2	2		13
Peak Hour Factor	0.82	0.82	0.82	0.71	0.71	0.71	0.93	0.93	0.93	0.90	0.90	0.90
Heavy Vehicles (%)	2%	2%	2%	2%	2%	2%	3%	3%	3%	3%	3%	3%
Adj. Flow (vph)	7	70	83	0	155	17	145	153	6	23	396	36
Shared Lane Traffic (%)												
Lane Group Flow (vph)	0	160	0	0	172	0	145	159	0	23	432	0
Turn Type	Perm	NA			NA		pm+pt	NA		Perm	NA	
Protected Phases		4			8		5	2			6	
Permitted Phases	4			8			2			6		
Detector Phase	4	4		8	8		5	2		6	6	
Switch Phase												
Minimum Initial (s)	7.0	7.0		7.0	7.0		7.0	10.0		10.0	10.0	
Minimum Split (s)	20.0	20.0		17.0	17.0		12.0	15.0		15.0	15.0	
Total Split (s)	20.0	20.0		20.0	20.0		12.0	40.0		28.0	28.0	
Total Split (%)	33.3%	33.3%		33.3%	33.3%		20.0%	66.7%		46.7%	46.7%	
Maximum Green (s)	15.1	15.1		15.0	15.0		7.2	35.2		23.2	23.2	
Yellow Time (s)	3.0	3.0		3.3	3.3		3.0	3.3		3.1	3.1	
All-Red Time (s)	1.9	1.9		1.7	1.7		1.8	1.5		1.7	1.7	
Lost Time Adjust (s)		0.1			0.0		0.2	0.2		0.2	0.2	
Total Lost Time (s)		5.0			5.0		5.0	5.0		5.0	5.0	
Lead/Lag							Lead			Lag	Lag	
Lead-Lag Optimize?							Yes			Yes	Yes	
Vehicle Extension (s)	2.0	2.0		2.0	2.0		2.0	2.0		2.0	2.0	
Recall Mode	None	None		None	None		None	C-Max		C-Max	C-Max	
Walk Time (s)	4.0	4.0		4.0	4.0			4.0		4.0	4.0	
Flash Dont Walk (s)	11.0	11.0		8.0	8.0			6.0		6.0	6.0	
Pedestrian Calls (#/hr)	0	0		0	0			0		0	0	
Act Effct Green (s)		10.2			10.2		42.2	43.2		33.5	33.5	
Actuated g/C Ratio		0.17			0.17		0.70	0.72		0.56	0.56	
v/c Ratio		0.56			0.55		0.24	0.12		0.03	0.43	

Lanes, Volumes, Timings
7: Hillsborough Street & E. Rosemary Street

2022 Build Alternative 1 AM Peak

Timing Plan: AM Peak



Lane Group	EBL	EBT	EBR	WBL	WBT	WBR	NBL	NBT	NBR	SBL	SBT	SBR
Control Delay		28.7			29.0		3.1	2.4		10.8	13.4	
Queue Delay		0.0			0.0		0.0	0.0		0.0	0.0	
Total Delay		28.7			29.0		3.1	2.4		10.8	13.4	
LOS		C			C		A	A		B	B	
Approach Delay		28.7			29.0			2.7				13.3
Approach LOS		C			C			A				B
Queue Length 50th (ft)		63			58		7	8		4	102	
Queue Length 95th (ft)		76			77		20	22		17	207	
Internal Link Dist (ft)		1115			447			283			646	
Turn Bay Length (ft)							100			100		
Base Capacity (vph)		418			458		615	1318		671	1011	
Starvation Cap Reductn		0			0		0	0		0	0	
Spillback Cap Reductn		0			0		0	0		0	0	
Storage Cap Reductn		0			0		0	0		0	0	
Reduced v/c Ratio		0.38			0.38		0.24	0.12		0.03	0.43	

Intersection Summary

Area Type:	Other
Cycle Length:	60
Actuated Cycle Length:	60
Offset:	14 (23%), Referenced to phase 2:NBTL and 6:SBTL, Start of Green
Natural Cycle:	55
Control Type:	Actuated-Coordinated
Maximum v/c Ratio:	0.56
Intersection Signal Delay:	15.1
Intersection LOS:	B
Intersection Capacity Utilization	53.4%
ICU Level of Service	A
Analysis Period (min)	15

Splits and Phases: 7: Hillsborough Street & E. Rosemary Street



Lanes, Volumes, Timings

2022 Build Alternative 1 AM Peak

8: Carolina Square Driveway/Church Street & W. Franklin Street

Timing Plan: AM Peak

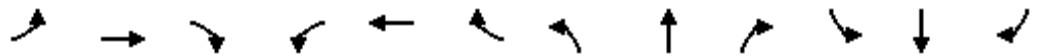

Lane Group	EBL	EBT	EBR	WBL	WBT	WBR	NBL	NBT	NBR	SBL	SBT	SBR
Lane Configurations												
Traffic Volume (vph)	49	336	23	10	248	43	2	5	10	20	20	49
Future Volume (vph)	49	336	23	10	248	43	2	5	10	20	20	49
Ideal Flow (vphpl)	1900	1900	1900	1900	1900	1900	1900	1900	1900	1900	1900	1900
Lane Width (ft)	10	10	16	10	10	10	12	12	12	12	12	12
Grade (%)		2%			-2%			-4%				-3%
Storage Length (ft)	150		0	200		0	0		100	0		0
Storage Lanes	1		0	1		0	0		1	0		0
Taper Length (ft)	25			25			25			25		
Lane Util. Factor	1.00	1.00	1.00	1.00	1.00	1.00	1.00	1.00	1.00	1.00	1.00	1.00
Ped Bike Factor	0.95	0.99		0.95	0.98			0.98	0.94		0.94	
Frt		0.991			0.978				0.850		0.926	
Flt Protected	0.950			0.950				0.985			0.989	
Satd. Flow (prot)	1430	1479	0	1431	1450	0	0	1621	1399	0	1431	0
Flt Permitted	0.551			0.503				0.884			0.918	
Satd. Flow (perm)	789	1479	0	721	1450	0	0	1423	1316	0	1317	0
Right Turn on Red			No			No			No			No
Satd. Flow (RTOR)												
Link Speed (mph)		20			20			20			25	
Link Distance (ft)		993			298			285			379	
Travel Time (s)		33.9			10.2			9.7			10.3	
Confl. Peds. (#/hr)	39		57	57		39	57		29	29		57
Peak Hour Factor	0.84	0.84	0.84	0.83	0.83	0.83	0.53	0.53	0.53	0.92	0.92	0.92
Heavy Vehicles (%)	5%	5%	5%	7%	7%	7%	6%	6%	6%	5%	5%	5%
Adj. Flow (vph)	58	400	27	12	299	52	4	9	19	22	22	53
Shared Lane Traffic (%)												
Lane Group Flow (vph)	58	427	0	12	351	0	0	13	19	0	97	0
Turn Type	Perm	NA		Perm	NA		Perm	NA	Perm	Perm	NA	
Protected Phases		2			6			8				4
Permitted Phases	2			6			8		8	4		
Detector Phase	2	2		6	6		8	8	8	4	4	
Switch Phase												
Minimum Initial (s)	10.0	10.0		10.0	10.0		7.0	7.0	7.0	7.0	7.0	
Minimum Split (s)	22.0	22.0		19.0	19.0		29.0	29.0	29.0	27.0	27.0	
Total Split (s)	31.0	31.0		31.0	31.0		29.0	29.0	29.0	29.0	29.0	
Total Split (%)	51.7%	51.7%		51.7%	51.7%		48.3%	48.3%	48.3%	48.3%	48.3%	
Maximum Green (s)	25.4	25.4		25.4	25.4		22.7	22.7	22.7	23.0	23.0	
Yellow Time (s)	3.3	3.3		3.3	3.3		3.1	3.1	3.1	3.4	3.4	
All-Red Time (s)	2.3	2.3		2.3	2.3		3.2	3.2	3.2	2.6	2.6	
Lost Time Adjust (s)	-0.6	-0.6		-0.6	-0.6		-1.3	-1.3	-1.3	-1.0	-1.0	
Total Lost Time (s)	5.0	5.0		5.0	5.0		5.0	5.0	5.0	5.0	5.0	
Lead/Lag												
Lead-Lag Optimize?												
Vehicle Extension (s)	3.0	3.0		3.0	3.0		2.0	2.0	2.0	2.0	2.0	
Recall Mode	C-Max	C-Max		C-Max	C-Max		None	None	None	None	None	
Walk Time (s)	7.0	7.0		7.0	7.0		7.0	7.0	7.0	7.0	7.0	
Flash Dont Walk (s)	9.0	9.0		6.0	6.0		15.0	15.0	15.0	14.0	14.0	
Pedestrian Calls (#/hr)	0	0		0	0		0	0	0	0	0	
Act Effect Green (s)	43.3	43.3		43.3	43.3		10.3	10.3	10.3	10.3	10.3	

Lanes, Volumes, Timings
 8: Carolina Square Driveway/Church Street & W. Franklin Street

2022 Build Alternative 1 AM Peak

Timing Plan: AM Peak



Lane Group	EBL	EBT	EBR	WBL	WBT	WBR	NBL	NBT	NBR	SBL	SBT	SBR
Actuated g/C Ratio	0.72	0.72		0.72	0.72			0.17	0.17			0.17
v/c Ratio	0.10	0.40		0.02	0.34			0.05	0.08			0.43
Control Delay	5.0	6.5		2.2	4.1			19.7	20.2			24.7
Queue Delay	0.0	0.0		0.0	0.0			0.0	0.0			0.0
Total Delay	5.0	6.5		2.2	4.1			19.7	20.2			24.7
LOS	A	A		A	A			B	C			C
Approach Delay		6.3			4.0			20.0				24.7
Approach LOS		A			A			C				C
Queue Length 50th (ft)	6	57		2	80			4	6			35
Queue Length 95th (ft)	20	119		m1	28			9	12			56
Internal Link Dist (ft)		913			218			205				299
Turn Bay Length (ft)	150			200					100			
Base Capacity (vph)	569	1067		520	1046			569	526			526
Starvation Cap Reductn	0	0		0	0			0	0			0
Spillback Cap Reductn	0	0		0	0			0	0			0
Storage Cap Reductn	0	0		0	0			0	0			0
Reduced v/c Ratio	0.10	0.40		0.02	0.34			0.02	0.04			0.18

Intersection Summary

Area Type: CBD
 Cycle Length: 60
 Actuated Cycle Length: 60
 Offset: 42 (70%), Referenced to phase 2:EBTL and 6:WBTL, Start of Green
 Natural Cycle: 60
 Control Type: Actuated-Coordinated
 Maximum v/c Ratio: 0.43
 Intersection Signal Delay: 7.7
 Intersection LOS: A
 Intersection Capacity Utilization 63.7%
 ICU Level of Service B
 Analysis Period (min) 15
 m Volume for 95th percentile queue is metered by upstream signal.

Splits and Phases: 8: Carolina Square Driveway/Church Street & W. Franklin Street

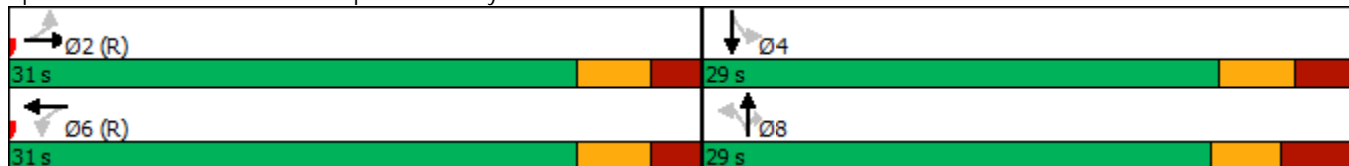

Lanes, Volumes, Timings

2022 Build Alternative 1 AM Peak

9: NC 86 (S. Columbia St)/NC 86 (N. Columbia St) & W. Franklin Street/E. Franklin Street AM Peak

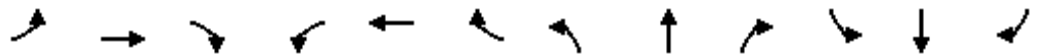

Lane Group	EBL	EBT	EBR	WBL	WBT	WBR	NBL	NBT	NBR	SBL	SBT	SBR
Lane Configurations												
Traffic Volume (vph)	70	283	29	65	275	46	30	317	87	36	460	79
Future Volume (vph)	70	283	29	65	275	46	30	317	87	36	460	79
Ideal Flow (vphpl)	1900	1900	1900	1900	1900	1900	1900	1900	1900	1900	1900	1900
Lane Width (ft)	9	12	13	10	10	13	9	10	10	9	9	11
Grade (%)		3%			1%			-2%			3%	
Storage Length (ft)	250		0	125		0	475		0	125		0
Storage Lanes	1		0	1		1	1		0	1		0
Taper Length (ft)	25			25			25			25		
Lane Util. Factor	1.00	0.95	0.95	1.00	1.00	1.00	1.00	0.95	0.95	1.00	0.95	0.95
Ped Bike Factor	0.87	0.99		0.95		0.79	0.97	0.96		0.91	0.99	
Frt		0.986				0.850		0.968			0.978	
Flt Protected	0.950			0.950			0.950			0.950		
Satd. Flow (prot)	1372	2980	0	1410	1484	1397	1342	2597	0	1346	2595	0
Flt Permitted	0.950			0.950			0.950			0.950		
Satd. Flow (perm)	1191	2980	0	1344	1484	1100	1298	2597	0	1228	2595	0
Right Turn on Red			No			No			No			No
Satd. Flow (RTOR)												
Link Speed (mph)		20			20			25			25	
Link Distance (ft)		457			941			981			353	
Travel Time (s)		15.6			32.1			26.8			9.6	
Confl. Peds. (#/hr)	125		49	49		125	29		98	98		29
Peak Hour Factor	0.80	0.80	0.80	0.87	0.87	0.87	0.93	0.93	0.93	0.85	0.85	0.85
Heavy Vehicles (%)	5%	5%	5%	7%	7%	7%	10%	10%	10%	7%	7%	7%
Adj. Flow (vph)	88	354	36	75	316	53	32	341	94	42	541	93
Shared Lane Traffic (%)												
Lane Group Flow (vph)	88	390	0	75	316	53	32	435	0	42	634	0
Turn Type	Prot	NA		Prot	NA	pm+ov	Prot	NA		Prot	NA	
Protected Phases	5	2		1	6	7	3	8		7	4	
Permitted Phases						6						
Detector Phase	5	2		1	6	7	3	8		7	4	
Switch Phase												
Minimum Initial (s)	7.0	10.0		7.0	10.0	7.0	7.0	7.0		7.0	7.0	
Minimum Split (s)	15.0	28.2		15.0	28.2	15.0	15.0	28.0		15.0	28.1	
Total Split (s)	22.0	38.0		22.0	38.0	22.0	22.0	38.0		22.0	38.0	
Total Split (%)	18.3%	31.7%		18.3%	31.7%	18.3%	18.3%	31.7%		18.3%	31.7%	
Maximum Green (s)	16.6	31.8		16.1	31.8	16.1	16.1	32.1		16.1	32.3	
Yellow Time (s)	3.0	3.0		3.0	3.0	3.0	3.0	3.3		3.0	3.1	
All-Red Time (s)	2.4	3.2		2.9	3.2	2.9	2.9	2.6		2.9	2.6	
Lost Time Adjust (s)	-0.4	-1.2		-0.9	-1.2	-2.0	-0.9	-0.9		-0.9	-0.7	
Total Lost Time (s)	5.0	5.0		5.0	5.0	3.9	5.0	5.0		5.0	5.0	
Lead/Lag	Lead	Lag		Lead	Lag	Lead	Lead	Lag		Lead	Lag	
Lead-Lag Optimize?												
Vehicle Extension (s)	1.0	3.0		1.0	3.0	1.0	1.0	2.0		1.0	2.0	
Recall Mode	None	C-Max		None	C-Max	None	None	Ped		None	Ped	
Walk Time (s)		7.0			7.0			7.0			7.0	
Flash Dont Walk (s)		15.0			15.0			15.0			15.0	
Pedestrian Calls (#/hr)		0			0			0			0	
Act Effect Green (s)	11.8	52.9		11.2	49.7	61.0	8.6	31.9		9.2	35.1	

Lanes, Volumes, Timings

2022 Build Alternative 1 AM Peak

9: NC 86 (S. Columbia St)/NC 86 (N. Columbia St) & W. Franklin Street/E. Franklin Street



Lane Group	EBL	EBT	EBR	WBL	WBT	WBR	NBL	NBT	NBR	SBL	SBT	SBR
Actuated g/C Ratio	0.10	0.44		0.09	0.41	0.51	0.07	0.27		0.08	0.29	
v/c Ratio	0.66	0.30		0.57	0.51	0.09	0.33	0.63		0.41	0.84	
Control Delay	77.6	23.7		79.5	22.2	9.1	80.9	21.3		93.3	29.5	
Queue Delay	0.0	0.0		0.0	0.0	0.0	0.0	0.0		0.0	0.2	
Total Delay	77.6	23.7		79.5	22.2	9.1	80.9	21.3		93.3	29.6	
LOS	E	C		E	C	A	F	C		F	C	
Approach Delay		33.6			30.3			25.4			33.6	
Approach LOS		C			C			C			C	
Queue Length 50th (ft)	70	95		61	95	11	17	161		31	245	
Queue Length 95th (ft)	112	138		109	#157	19	m45	155		71	64	
Internal Link Dist (ft)		377			861			901			273	
Turn Bay Length (ft)	250			125			475			125		
Base Capacity (vph)	194	1313		199	614	675	190	758		190	782	
Starvation Cap Reductn	0	0		0	0	0	0	0		0	7	
Spillback Cap Reductn	0	0		0	0	0	0	0		0	0	
Storage Cap Reductn	0	0		0	0	0	0	0		0	0	
Reduced v/c Ratio	0.45	0.30		0.38	0.51	0.08	0.17	0.57		0.22	0.82	

Intersection Summary

Area Type: CBD
 Cycle Length: 120
 Actuated Cycle Length: 120
 Offset: 0 (0%), Referenced to phase 2:EBT and 6:WBT, Start of Green
 Natural Cycle: 90
 Control Type: Actuated-Coordinated
 Maximum v/c Ratio: 0.84
 Intersection Signal Delay: 31.0 Intersection LOS: C
 Intersection Capacity Utilization 65.0% ICU Level of Service C
 Analysis Period (min) 15
 # 95th percentile volume exceeds capacity, queue may be longer.
 Queue shown is maximum after two cycles.
 m Volume for 95th percentile queue is metered by upstream signal.

Splits and Phases: 9: NC 86 (S. Columbia St)/NC 86 (N. Columbia St) & W. Franklin Street/E. Franklin Street

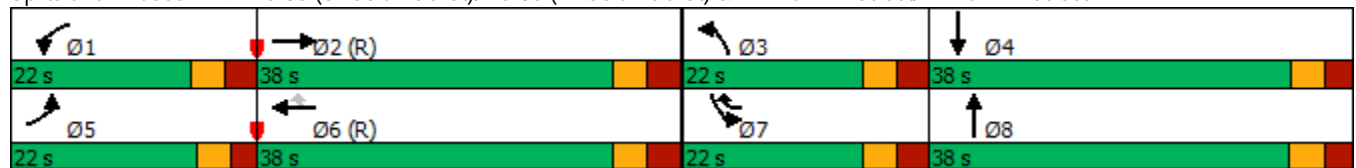

Lanes, Volumes, Timings
 10: E. Franklin Street & Henderson Street

2022 Build Alternative 1 AM Peak
 Timing Plan: AM Peak



Lane Group	EBL	EBT	WBT	WBR	SBL	SBR
Lane Configurations		↕↕	↕↔		↔↕	
Traffic Volume (vph)	15	366	384	68	65	17
Future Volume (vph)	15	366	384	68	65	17
Ideal Flow (vphpl)	1900	1900	1900	1900	1900	1900
Lane Width (ft)	10	13	10	10	11	11
Grade (%)		-2%	2%		3%	
Lane Util. Factor	0.95	0.95	0.95	0.95	1.00	1.00
Ped Bike Factor		1.00	0.99		0.95	
Frt			0.977		0.971	
Flt Protected		0.998			0.962	
Satd. Flow (prot)	0	3223	2763	0	1434	0
Flt Permitted		0.933			0.962	
Satd. Flow (perm)	0	3010	2763	0	1387	0
Right Turn on Red				No		No
Satd. Flow (RTOR)						
Link Speed (mph)		20	20		20	
Link Distance (ft)		941	1200		366	
Travel Time (s)		32.1	40.9		12.5	
Confl. Peds. (#/hr)	26			26	44	87
Peak Hour Factor	0.91	0.91	0.90	0.90	0.79	0.79
Heavy Vehicles (%)	5%	5%	5%	5%	4%	4%
Parking (#/hr)						0
Adj. Flow (vph)	16	402	427	76	82	22
Shared Lane Traffic (%)						
Lane Group Flow (vph)	0	418	503	0	104	0
Turn Type	Perm	NA	NA		Prot	
Protected Phases		2	6		4	
Permitted Phases	2					
Detector Phase	2	2	6		4	
Switch Phase						
Minimum Initial (s)	10.0	10.0	10.0		7.0	
Minimum Split (s)	17.0	17.0	22.0		25.0	
Total Split (s)	32.0	32.0	32.0		28.0	
Total Split (%)	53.3%	53.3%	53.3%		46.7%	
Maximum Green (s)	25.8	25.8	25.9		22.9	
Yellow Time (s)	3.0	3.0	3.0		3.0	
All-Red Time (s)	3.2	3.2	3.1		2.1	
Lost Time Adjust (s)		-1.2	-1.1		-0.1	
Total Lost Time (s)		5.0	5.0		5.0	
Lead/Lag						
Lead-Lag Optimize?						
Vehicle Extension (s)	2.0	2.0	2.0		1.0	
Recall Mode	C-Max	C-Max	C-Max		None	
Walk Time (s)			7.0		7.0	
Flash Dont Walk (s)			8.0		12.0	
Pedestrian Calls (#/hr)			0		0	
Act Effct Green (s)		44.6	44.6		8.8	
Actuated g/C Ratio		0.74	0.74		0.15	
v/c Ratio		0.19	0.25		0.50	

Lanes, Volumes, Timings
 10: E. Franklin Street & Henderson Street

2022 Build Alternative 1 AM Peak
 Timing Plan: AM Peak

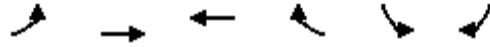

Lane Group	EBL	EBT	WBT	WBR	SBL	SBR
Control Delay		6.7	4.9		28.7	
Queue Delay		0.0	0.0		0.0	
Total Delay		6.7	4.9		28.7	
LOS		A	A		C	
Approach Delay		6.7	4.9		28.7	
Approach LOS		A	A		C	
Queue Length 50th (ft)		97	117		33	
Queue Length 95th (ft)		152	18		50	
Internal Link Dist (ft)		861	1120		286	
Turn Bay Length (ft)						
Base Capacity (vph)		2237	2053		549	
Starvation Cap Reductn		0	0		0	
Spillback Cap Reductn		0	0		0	
Storage Cap Reductn		0	0		0	
Reduced v/c Ratio		0.19	0.25		0.19	

Intersection Summary

Area Type:	CBD
Cycle Length:	60
Actuated Cycle Length:	60
Offset:	53 (88%), Referenced to phase 2:EBTL and 6:WBT, Start of Green
Natural Cycle:	50
Control Type:	Actuated-Coordinated
Maximum v/c Ratio:	0.50
Intersection Signal Delay:	8.0
Intersection LOS:	A
Intersection Capacity Utilization:	47.1%
ICU Level of Service:	A
Analysis Period (min):	15

Splits and Phases: 10: E. Franklin Street & Henderson Street

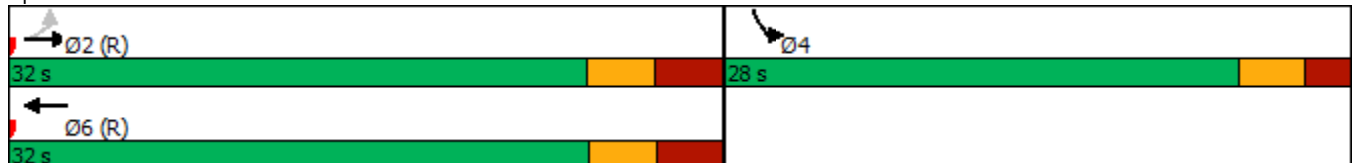

Lanes, Volumes, Timings

2022 Build Alternative 1 AM Peak

11: Raleigh Street/Hillsborough Street & E. Franklin Street

Timing Plan: AM Peak

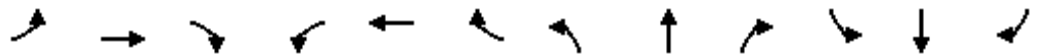

Lane Group	EBL	EBT	EBR	WBL	WBT	WBR	NBL	NBT	NBR	SBL	SBT	SBR
Lane Configurations												
Traffic Volume (vph)	19	312	103	42	416	84	78	172	23	67	336	18
Future Volume (vph)	19	312	103	42	416	84	78	172	23	67	336	18
Ideal Flow (vphpl)	1900	1900	1900	1900	1900	1900	1900	1900	1900	1900	1900	1900
Lane Width (ft)	9	9	10	9	10	11	12	12	12	10	10	10
Grade (%)		1%			-2%			1%			1%	
Storage Length (ft)	75		0	75		0	0		0	100		0
Storage Lanes	1		0	1		0	0		0	1		0
Taper Length (ft)	25			25			25			25		
Lane Util. Factor	1.00	0.95	0.95	1.00	0.95	0.95	1.00	1.00	1.00	1.00	1.00	1.00
Ped Bike Factor	0.99	0.99		0.99	0.99			0.99		0.99	1.00	
Frt		0.963			0.975			0.989			0.992	
Flt Protected	0.950			0.950				0.986		0.950		
Satd. Flow (prot)	1539	2934	0	1578	3173	0	0	1768	0	1627	1695	0
Flt Permitted	0.404			0.439				0.632		0.502		
Satd. Flow (perm)	651	2934	0	721	3173	0	0	1129	0	852	1695	0
Right Turn on Red			No			No			No			No
Satd. Flow (RTOR)												
Link Speed (mph)		20			30			25			25	
Link Distance (ft)		1200			1013			995			363	
Travel Time (s)		40.9			23.0			27.1			9.9	
Confl. Peds. (#/hr)	9		16	16		9	25		11	11		25
Peak Hour Factor	0.86	0.86	0.86	0.92	0.92	0.92	0.83	0.83	0.83	0.96	0.96	0.96
Heavy Vehicles (%)	5%	5%	5%	4%	4%	4%	4%	4%	4%	3%	3%	3%
Adj. Flow (vph)	22	363	120	46	452	91	94	207	28	70	350	19
Shared Lane Traffic (%)												
Lane Group Flow (vph)	22	483	0	46	543	0	0	329	0	70	369	0
Turn Type	Perm	NA		Perm	NA		pm+pt	NA		D.Pm	NA	
Protected Phases		2			6		7	4				8
Permitted Phases	2			6			4			4		
Detector Phase	2	2		6	6		7	4		4		8
Switch Phase												
Minimum Initial (s)	10.0	10.0		10.0	10.0		7.0	7.0		7.0	7.0	
Minimum Split (s)	16.0	16.0		16.0	16.0		14.0	30.0		30.0	29.0	
Total Split (s)	47.0	47.0		47.0	47.0		28.0	73.0		73.0	45.0	
Total Split (%)	39.2%	39.2%		39.2%	39.2%		23.3%	60.8%		60.8%	37.5%	
Maximum Green (s)	41.7	41.7		41.7	41.7		21.8	66.6		66.6	38.6	
Yellow Time (s)	3.0	3.0		3.0	3.0		3.0	3.1		3.1	3.1	
All-Red Time (s)	2.3	2.3		2.3	2.3		3.2	3.3		3.3	3.3	
Lost Time Adjust (s)	-0.3	-0.3		-0.3	-0.3			-1.4		-1.4	-1.4	
Total Lost Time (s)	5.0	5.0		5.0	5.0			5.0		5.0	5.0	
Lead/Lag							Lead				Lag	
Lead-Lag Optimize?												
Vehicle Extension (s)	3.0	3.0		3.0	3.0		3.0	2.0		2.0	2.0	
Recall Mode	C-Max	C-Max		C-Max	C-Max		None	None		None	None	
Walk Time (s)								7.0		7.0	7.0	
Flash Dont Walk (s)								16.0		16.0	15.0	
Pedestrian Calls (#/hr)								0		0	0	
Act Effect Green (s)	60.7	60.7		60.7	60.7			49.3		49.3	49.3	



Lane Group	EBL	EBT	EBR	WBL	WBT	WBR	NBL	NBT	NBR	SBL	SBT	SBR
Actuated g/C Ratio	0.51	0.51		0.51	0.51			0.41		0.41	0.41	
v/c Ratio	0.07	0.33		0.13	0.34			0.71		0.20	0.53	
Control Delay	14.2	13.3		22.0	20.8			36.7		17.0	24.0	
Queue Delay	0.0	0.0		0.0	0.0			0.0		0.0	2.4	
Total Delay	14.2	13.3		22.0	20.8			36.7		17.0	26.4	
LOS	B	B		C	C			D		B	C	
Approach Delay		13.4			20.9			36.7			24.9	
Approach LOS		B			C			D			C	
Queue Length 50th (ft)	6	71		18	128			207		32	198	
Queue Length 95th (ft)	15	87		53	218			217		53	234	
Internal Link Dist (ft)		1120			933			915			283	
Turn Bay Length (ft)	75			75						100		
Base Capacity (vph)	329	1484		365	1605			639		482	718	
Starvation Cap Reductn	0	0		0	0			0		0	225	
Spillback Cap Reductn	0	0		0	0			0		0	0	
Storage Cap Reductn	0	0		0	0			0		0	0	
Reduced v/c Ratio	0.07	0.33		0.13	0.34			0.51		0.15	0.75	

Intersection Summary

Area Type: Other
 Cycle Length: 120
 Actuated Cycle Length: 120
 Offset: 61 (51%), Referenced to phase 2:EBTL and 6:WBTL, Start of Green
 Natural Cycle: 60
 Control Type: Actuated-Coordinated
 Maximum v/c Ratio: 0.71
 Intersection Signal Delay: 22.6 Intersection LOS: C
 Intersection Capacity Utilization 74.4% ICU Level of Service D
 Analysis Period (min) 15

Splits and Phases: 11: Raleigh Street/Hillsborough Street & E. Franklin Street

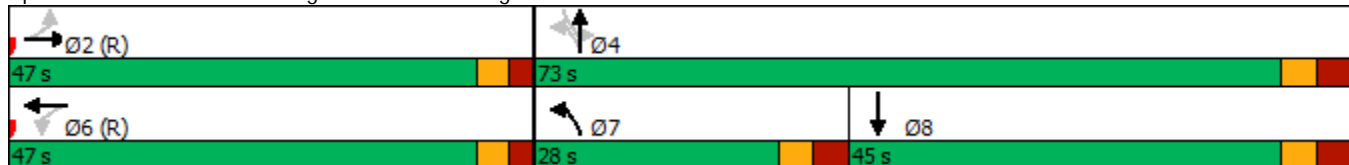

Lanes, Volumes, Timings

2022 Build Alternative 1 AM Peak

14: NC 86 (MLK Jr. Blvd) & Longview Street/Mill Creek Apts Driveway

Timing Plan: AM Peak

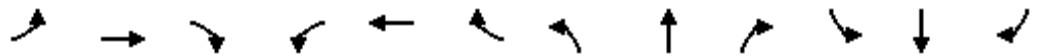

Lane Group	EBL	EBT	EBR	WBL	WBT	WBR	NBL	NBT	NBR	SBL	SBT	SBR
Lane Configurations		↕			↕		↕	↕↔		↕	↕↔	
Traffic Volume (vph)	77	0	10	6	0	5	2	432	5	0	724	66
Future Volume (vph)	77	0	10	6	0	5	2	432	5	0	724	66
Ideal Flow (vphpl)	1900	1900	1900	1900	1900	1900	1900	1900	1900	1900	1900	1900
Grade (%)		-6%			1%			2%				-4%
Storage Length (ft)	0		0	0		0	225		0	250		0
Storage Lanes	0		0	0		0	1		0	1		0
Taper Length (ft)	25			25			25			25		
Lane Util. Factor	1.00	1.00	1.00	1.00	1.00	1.00	1.00	0.95	0.95	1.00	0.95	0.95
Ped Bike Factor		1.00			0.99		1.00	1.00			1.00	
Frt		0.985			0.944			0.998			0.987	
Flt Protected		0.958			0.972		0.950					
Satd. Flow (prot)	0	1737	0	0	1701	0	1686	3364	0	1846	3453	0
Flt Permitted		0.742			0.816		0.259					
Satd. Flow (perm)	0	1345	0	0	1418	0	459	3364	0	1846	3453	0
Right Turn on Red			No			No			No			No
Satd. Flow (RTOR)												
Link Speed (mph)		25			20			35			35	
Link Distance (ft)		451			338			2108			784	
Travel Time (s)		12.3			11.5			41.1			15.3	
Confl. Peds. (#/hr)			16	16			4		4	4		4
Peak Hour Factor	0.52	0.52	0.52	0.92	0.92	0.92	0.93	0.93	0.93	0.84	0.84	0.84
Heavy Vehicles (%)	6%	6%	6%	2%	2%	2%	6%	6%	6%	5%	5%	5%
Adj. Flow (vph)	148	0	19	7	0	5	2	465	5	0	862	79
Shared Lane Traffic (%)												
Lane Group Flow (vph)	0	167	0	0	12	0	2	470	0	0	941	0
Turn Type	Perm	NA		Perm	NA		Perm	NA		Perm	NA	
Protected Phases		4			8			2			6	
Permitted Phases	4			8			2			6		
Detector Phase	4	4		8	8		2	2		6	6	
Switch Phase												
Minimum Initial (s)	7.0	7.0		7.0	7.0		12.0	12.0		12.0	12.0	
Minimum Split (s)	31.0	31.0		14.0	14.0		28.0	28.0		28.0	28.0	
Total Split (s)	20.0	20.0		20.0	20.0		60.0	60.0		60.0	60.0	
Total Split (%)	25.0%	25.0%		25.0%	25.0%		75.0%	75.0%		75.0%	75.0%	
Maximum Green (s)	14.0	14.0		13.9	13.9		54.0	54.0		54.5	54.5	
Yellow Time (s)	3.5	3.5		3.0	3.0		4.5	4.5		4.0	4.0	
All-Red Time (s)	2.5	2.5		3.1	3.1		1.5	1.5		1.5	1.5	
Lost Time Adjust (s)		-1.0			-1.0		-1.0	-1.0		-0.5	-0.5	
Total Lost Time (s)		5.0			5.1		5.0	5.0		5.0	5.0	
Lead/Lag												
Lead-Lag Optimize?												
Vehicle Extension (s)	3.0	3.0		3.0	3.0		3.0	3.0		3.0	3.0	
Recall Mode	None	None		None	None		Min	Min		Min	Min	
Walk Time (s)	7.0	7.0					7.0	7.0		7.0	7.0	
Flash Dont Walk (s)	17.0	17.0					9.0	9.0		9.0	9.0	
Pedestrian Calls (#/hr)	0	0					0	0		0	0	
Act Effct Green (s)		11.8			11.7		22.5	22.5			22.5	
Actuated g/C Ratio		0.27			0.26		0.51	0.51			0.51	

Lanes, Volumes, Timings

2022 Build Alternative 1 AM Peak

14: NC 86 (MLK Jr. Blvd) & Longview Street/Mill Creek Apts Driveway

Timing Plan: AM Peak

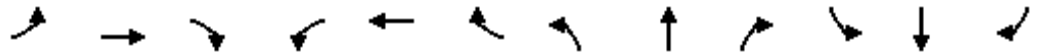

Lane Group	EBL	EBT	EBR	WBL	WBT	WBR	NBL	NBT	NBR	SBL	SBT	SBR
v/c Ratio		0.47			0.03		0.01	0.28				0.54
Control Delay		18.6			12.8		6.0	7.1				9.2
Queue Delay		0.0			0.0		0.0	0.0				0.0
Total Delay		18.6			12.8		6.0	7.1				9.2
LOS		B			B		A	A				A
Approach Delay		18.6			12.8			7.1				9.2
Approach LOS		B			B			A				A
Queue Length 50th (ft)		31			2		0	31				73
Queue Length 95th (ft)		44			12		3	60				118
Internal Link Dist (ft)		371			258			2028				704
Turn Bay Length (ft)							225					
Base Capacity (vph)		461			483		459	3364				3453
Starvation Cap Reductn		0			0		0	0				0
Spillback Cap Reductn		0			0		0	0				0
Storage Cap Reductn		0			0		0	0				0
Reduced v/c Ratio		0.36			0.02		0.00	0.14				0.27

Intersection Summary

Area Type:	Other
Cycle Length:	80
Actuated Cycle Length:	44.4
Natural Cycle:	60
Control Type:	Actuated-Uncoordinated
Maximum v/c Ratio:	0.54
Intersection Signal Delay:	9.6
Intersection LOS:	A
Intersection Capacity Utilization:	43.2%
ICU Level of Service:	A
Analysis Period (min):	15

Splits and Phases: 14: NC 86 (MLK Jr. Blvd) & Longview Street/Mill Creek Apts Driveway



Lanes, Volumes, Timings
 15: NC 86 (Pittsboro St) & W. Cameron Avenue

2022 Build Alternative 1 AM Peak
 Timing Plan: AM Peak



Lane Group	EBT	EBR	WBL	WBT	NBL	NBR	Ø1	Ø4
Lane Configurations	↻		↻↻	↻				
Traffic Volume (vph)	117	159	601	134	0	0		
Future Volume (vph)	117	159	601	134	0	0		
Ideal Flow (vphpl)	1900	1900	1900	1900	1900	1900		
Lane Width (ft)	12	12	11	12	12	12		
Grade (%)	3%			-3%	0%			
Storage Length (ft)		0	75		0	0		
Storage Lanes		0	0		0	0		
Taper Length (ft)			25		25			
Lane Util. Factor	1.00	1.00	0.97	1.00	1.00	1.00		
Ped Bike Factor	0.94		0.90					
Frt	0.922							
Flt Protected			0.950					
Satd. Flow (prot)	1432	0	2837	1592	0	0		
Flt Permitted			0.950					
Satd. Flow (perm)	1432	0	2562	1592	0	0		
Right Turn on Red		No				No		
Satd. Flow (RTOR)								
Link Speed (mph)	25			25	25			
Link Distance (ft)	391			120	794			
Travel Time (s)	30.0			10.7	21.7			
Confl. Peds. (#/hr)		57	57					
Peak Hour Factor	0.81	0.81	0.87	0.87	0.90	0.90		
Heavy Vehicles (%)	2%	2%	9%	9%	2%	2%		
Adj. Flow (vph)	144	196	691	154	0	0		
Shared Lane Traffic (%)								
Lane Group Flow (vph)	340	0	691	154	0	0		
Turn Type	NA		Prot	NA				
Protected Phases	2		1 4	6			1	4
Permitted Phases								
Detector Phase	2		1 4	6				
Switch Phase								
Minimum Initial (s)	10.0			10.0			7.0	7.0
Minimum Split (s)	17.0			15.0			13.0	20.0
Total Split (s)	25.0			40.0			15.0	20.0
Total Split (%)	41.7%			66.7%			25%	33%
Maximum Green (s)	19.9			35.0			9.9	16.0
Yellow Time (s)	3.0			3.3			3.0	3.0
All-Red Time (s)	2.1			1.7			2.1	1.0
Lost Time Adjust (s)	-0.1			0.0				
Total Lost Time (s)	5.0			5.0				
Lead/Lag	Lag						Lead	
Lead-Lag Optimize?								
Vehicle Extension (s)	1.0			1.0			4.0	0.2
Recall Mode	None			C-Max			C-Max	None
Walk Time (s)	7.0							7.0
Flash Dont Walk (s)	4.0							9.0
Pedestrian Calls (#/hr)	0							0
Act Effect Green (s)	20.0		30.0	38.8				

Lanes, Volumes, Timings
 15: NC 86 (Pittsboro St) & W. Cameron Avenue

2022 Build Alternative 1 AM Peak
 Timing Plan: AM Peak



Lane Group	EBT	EBR	WBL	WBT	NBL	NBR	Ø1	Ø4
Actuated g/C Ratio	0.33		0.50	0.65				
v/c Ratio	0.71		0.49	0.15				
Control Delay	28.0		14.4	5.9				
Queue Delay	0.0		0.0	0.0				
Total Delay	28.0		14.4	5.9				
LOS	C		B	A				
Approach Delay	28.0			12.9				
Approach LOS	C			B				
Queue Length 50th (ft)	105		190	30				
Queue Length 95th (ft)	163		186	m84				
Internal Link Dist (ft)	311			40	714			
Turn Bay Length (ft)			75					
Base Capacity (vph)	477		1374	1028				
Starvation Cap Reductn	0		0	0				
Spillback Cap Reductn	0		0	0				
Storage Cap Reductn	0		0	0				
Reduced v/c Ratio	0.71		0.50	0.15				

Intersection Summary

Area Type: CBD
 Cycle Length: 60
 Actuated Cycle Length: 60
 Offset: 23 (38%), Referenced to phase 1:WBL and 6:WBT, Start of Green
 Natural Cycle: 60
 Control Type: Actuated-Coordinated
 Maximum v/c Ratio: 0.71
 Intersection Signal Delay: 17.2 Intersection LOS: B
 Intersection Capacity Utilization 47.5% ICU Level of Service A
 Analysis Period (min) 15
 m Volume for 95th percentile queue is metered by upstream signal.

Splits and Phases: 15: NC 86 (Pittsboro St) & W. Cameron Avenue

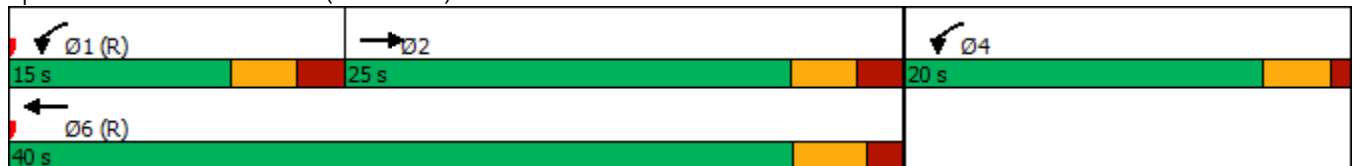

Lanes, Volumes, Timings

2022 Build Alternative 1 AM Peak

16: NC 86 (S. Columbia St) & W. Cameron Avenue/E. Cameron Avenue

Timing Plan: AM Peak

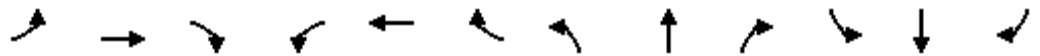

Lane Group	EBL	EBT	EBR	WBL	WBT	WBR	NBL	NBT	NBR	SBL	SBT	SBR
Lane Configurations												
Traffic Volume (vph)	16	91	0	0	95	20	98	391	43	66	0	538
Future Volume (vph)	16	91	0	0	95	20	98	391	43	66	0	538
Ideal Flow (vphpl)	1900	1900	1900	1900	1900	1900	1900	1900	1900	1900	1900	1900
Lane Width (ft)	11	12	12	12	12	12	10	10	10	11	11	12
Grade (%)		1%			-1%			1%			2%	
Storage Length (ft)	100		0	0		0	0		0	310		0
Storage Lanes	1		0	0		0	1		0	1		2
Taper Length (ft)	25			25			25			25		
Lane Util. Factor	1.00	1.00	1.00	1.00	1.00	1.00	0.91	0.91	0.95	1.00	1.00	0.88
Ped Bike Factor	0.95				0.99		0.79	0.95		0.75		0.77
Frt					0.977			0.985				0.850
Flt Protected	0.950						0.950	0.999		0.950		
Satd. Flow (prot)	1532	1668	0	0	1565	0	1248	2456	0	1413	0	2302
Flt Permitted	0.522						0.950	0.999		0.950		
Satd. Flow (perm)	803	1668	0	0	1565	0	982	2445	0	1063	0	1776
Right Turn on Red			No			No			No			No
Satd. Flow (RTOR)												
Link Speed (mph)		25			25			25				25
Link Distance (ft)		273			989			826				981
Travel Time (s)		10.7			57.6			22.5				26.8
Confl. Peds. (#/hr)	39		102	102		39	71		107	107		71
Peak Hour Factor	0.79	0.79	0.79	0.83	0.83	0.83	0.86	0.86	0.86	0.89	0.89	0.89
Heavy Vehicles (%)	2%	2%	2%	6%	6%	6%	10%	10%	10%	10%	10%	10%
Adj. Flow (vph)	20	115	0	0	114	24	114	455	50	74	0	604
Shared Lane Traffic (%)							10%					
Lane Group Flow (vph)	20	115	0	0	138	0	103	516	0	74	0	604
Turn Type	Perm	NA			NA		Split	NA		Prot		Prot
Protected Phases		4			8		2	2		1		1
Permitted Phases	4									1		1
Detector Phase	4	4			8		2	2		1		1
Switch Phase												
Minimum Initial (s)	10.0	10.0			10.0		7.0	7.0		7.0		7.0
Minimum Split (s)	24.0	24.0			31.0		18.0	18.0		26.0		26.0
Total Split (s)	34.0	34.0			34.0		22.0	22.0		36.0		36.0
Total Split (%)	28.3%	28.3%			28.3%		18.3%	18.3%		30.0%		30.0%
Maximum Green (s)	27.8	27.8			27.8		16.1	16.1		30.4		30.4
Yellow Time (s)	3.2	3.2			3.2		3.1	3.1		3.0		3.0
All-Red Time (s)	3.0	3.0			3.0		2.8	2.8		2.6		2.6
Lost Time Adjust (s)	-1.2	-1.2			-1.2		-0.9	-0.9		-0.6		-0.6
Total Lost Time (s)	5.0	5.0			5.0		5.0	5.0		5.0		5.0
Lead/Lag							Lag	Lag		Lead		Lead
Lead-Lag Optimize?							Yes	Yes		Yes		Yes
Vehicle Extension (s)	2.0	2.0			2.0		4.0	4.0		4.0		4.0
Recall Mode	None	None			None		C-Max	C-Max		None		None
Walk Time (s)	7.0	7.0			7.0		7.0	7.0		7.0		7.0
Flash Dont Walk (s)	10.0	10.0			17.0		5.0	5.0		13.0		13.0
Pedestrian Calls (#/hr)	0	0			0		0	0		0		0
Act Effect Green (s)	16.4	16.4			16.4		46.7	46.7		41.9		41.9

Lane Group	Ø9
Lane Configurations	
Traffic Volume (vph)	
Future Volume (vph)	
Ideal Flow (vphpl)	
Lane Width (ft)	
Grade (%)	
Storage Length (ft)	
Storage Lanes	
Taper Length (ft)	
Lane Util. Factor	
Ped Bike Factor	
Frt	
Flt Protected	
Satd. Flow (prot)	
Flt Permitted	
Satd. Flow (perm)	
Right Turn on Red	
Satd. Flow (RTOR)	
Link Speed (mph)	
Link Distance (ft)	
Travel Time (s)	
Confl. Peds. (#/hr)	
Peak Hour Factor	
Heavy Vehicles (%)	
Adj. Flow (vph)	
Shared Lane Traffic (%)	
Lane Group Flow (vph)	
Turn Type	
Protected Phases	9
Permitted Phases	
Detector Phase	
Switch Phase	
Minimum Initial (s)	7.0
Minimum Split (s)	28.0
Total Split (s)	28.0
Total Split (%)	23%
Maximum Green (s)	24.0
Yellow Time (s)	3.0
All-Red Time (s)	1.0
Lost Time Adjust (s)	
Total Lost Time (s)	
Lead/Lag	
Lead-Lag Optimize?	
Vehicle Extension (s)	0.2
Recall Mode	None
Walk Time (s)	7.0
Flash Dont Walk (s)	17.0
Pedestrian Calls (#/hr)	0
Act Effect Green (s)	

Lanes, Volumes, Timings

2022 Build Alternative 1 AM Peak

16: NC 86 (S. Columbia St) & W. Cameron Avenue/E. Cameron Avenue

Timing Plan: AM Peak



Lane Group	EBL	EBT	EBR	WBL	WBT	WBR	NBL	NBT	NBR	SBL	SBT	SBR
Actuated g/C Ratio	0.14	0.14			0.14		0.39	0.39		0.35		0.35
v/c Ratio	0.18	0.50			0.64		0.21	0.54		0.15		0.75
Control Delay	36.2	41.1			62.3		28.0	32.3		7.1		17.0
Queue Delay	0.0	0.0			0.0		0.0	0.0		0.0		0.0
Total Delay	36.2	41.1			62.3		28.0	32.3		7.1		17.0
LOS	D	D			E		C	C		A		B
Approach Delay		40.4			62.3			31.6			16.0	
Approach LOS		D			E			C			B	
Queue Length 50th (ft)	11	82			103		57	167		5		83
Queue Length 95th (ft)	m15	m109			148		110	239		m16		299
Internal Link Dist (ft)		193			909			746			901	
Turn Bay Length (ft)	100									310		
Base Capacity (vph)	194	403			378		485	954		493		803
Starvation Cap Reductn	0	0			0		0	0		0		0
Spillback Cap Reductn	0	0			0		0	0		0		0
Storage Cap Reductn	0	0			0		0	0		0		0
Reduced v/c Ratio	0.10	0.29			0.37		0.21	0.54		0.15		0.75

Intersection Summary

Area Type: CBD
 Cycle Length: 120
 Actuated Cycle Length: 120
 Offset: 39 (33%), Referenced to phase 2:NBTL, Start of Green
 Natural Cycle: 125
 Control Type: Actuated-Coordinated
 Maximum v/c Ratio: 0.75
 Intersection Signal Delay: 28.3
 Intersection LOS: C
 Intersection Capacity Utilization 67.9%
 ICU Level of Service C
 Analysis Period (min) 15
 m Volume for 95th percentile queue is metered by upstream signal.

Splits and Phases: 16: NC 86 (S. Columbia St) & W. Cameron Avenue/E. Cameron Avenue

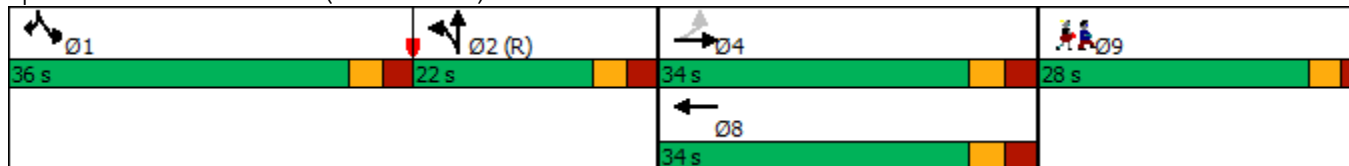

Lane Group	Ø9
Actuated g/C Ratio	
v/c Ratio	
Control Delay	
Queue Delay	
Total Delay	
LOS	
Approach Delay	
Approach LOS	
Queue Length 50th (ft)	
Queue Length 95th (ft)	
Internal Link Dist (ft)	
Turn Bay Length (ft)	
Base Capacity (vph)	
Starvation Cap Reductn	
Spillback Cap Reductn	
Storage Cap Reductn	
Reduced v/c Ratio	
Intersection Summary	

Lanes, Volumes, Timings

2022 Build Alternative 1 AM Peak

17: Raleigh Street & E. Cameron Avenue/Country Club Road

Timing Plan: AM Peak

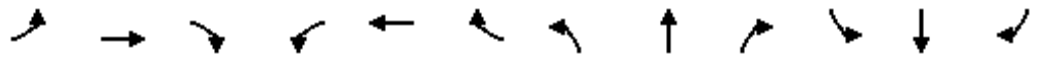

Lane Group	EBL	EBT	EBR	WBL	WBT	WBR	NBL	NBT	NBR	SBL	SBT	SBR
Lane Configurations		↕		↖	↗		↖	↗		↖	↗	
Traffic Volume (vph)	23	44	32	28	142	210	24	45	17	298	148	48
Future Volume (vph)	23	44	32	28	142	210	24	45	17	298	148	48
Ideal Flow (vphpl)	1900	1900	1900	1900	1900	1900	1900	1900	1900	1900	1900	1900
Grade (%)		-3%			3%			-2%				1%
Storage Length (ft)	0		0	150		0	125		0	75		0
Storage Lanes	0		0	1		0	1		0	1		0
Taper Length (ft)	25			25			25			25		
Lane Util. Factor	1.00	1.00	1.00	1.00	1.00	1.00	1.00	1.00	1.00	1.00	1.00	1.00
Ped Bike Factor		0.98		0.98	0.98		0.91	0.96		0.89	0.95	
Frt		0.956			0.911			0.958			0.963	
Flt Protected		0.989		0.950			0.950			0.950		
Satd. Flow (prot)	0	1493	0	1569	1474	0	1492	1446	0	1569	1509	0
Flt Permitted		0.834		0.568			0.628			0.455		
Satd. Flow (perm)	0	1257	0	924	1474	0	896	1446	0	671	1509	0
Right Turn on Red			No			No			No			No
Satd. Flow (RTOR)												
Link Speed (mph)		25			25			25				25
Link Distance (ft)		598			651			409				995
Travel Time (s)		16.3			17.8			11.2				27.1
Confl. Peds. (#/hr)	3		6	6		3	31		25	25		31
Peak Hour Factor	0.71	0.71	0.71	0.84	0.84	0.84	0.79	0.79	0.79	0.94	0.94	0.94
Heavy Vehicles (%)	8%	8%	8%	2%	2%	2%	10%	10%	10%	3%	3%	3%
Adj. Flow (vph)	32	62	45	33	169	250	30	57	22	317	157	51
Shared Lane Traffic (%)												
Lane Group Flow (vph)	0	139	0	33	419	0	30	79	0	317	208	0
Turn Type	Perm	NA		pm+pt	NA		pm+pt	NA		pm+pt	NA	
Protected Phases		2		1	6		3	8		7	4	
Permitted Phases	2			6			8			4		
Detector Phase	2	2		1	6		3	8		7	4	
Switch Phase												
Minimum Initial (s)	10.0	10.0		7.0	10.0		7.0	7.0		7.0	7.0	
Minimum Split (s)	18.0	18.0		13.0	19.0		13.0	19.0		12.0	16.0	
Total Split (s)	50.0	50.0		20.0	70.0		20.0	35.0		20.0	35.0	
Total Split (%)	40.0%	40.0%		16.0%	56.0%		16.0%	28.0%		16.0%	28.0%	
Maximum Green (s)	43.9	43.9		14.4	64.4		14.7	29.7		15.1	29.9	
Yellow Time (s)	3.3	3.3		3.0	3.1		3.0	3.1		3.0	3.1	
All-Red Time (s)	2.8	2.8		2.6	2.5		2.3	2.2		1.9	2.0	
Lost Time Adjust (s)		-1.1		-0.6	-0.6		-0.3	-0.3		0.1	-0.1	
Total Lost Time (s)		5.0		5.0	5.0		5.0	5.0		5.0	5.0	
Lead/Lag	Lag	Lag		Lead			Lead	Lag		Lead	Lag	
Lead-Lag Optimize?	Yes	Yes		Yes			Yes	Yes		Yes	Yes	
Vehicle Extension (s)	2.0	2.0		2.0	2.0		2.0	2.0		2.0	2.0	
Recall Mode	None	None		None	None		None	None		None	None	
Walk Time (s)	4.0	4.0			4.0			4.0			4.0	
Flash Dont Walk (s)	7.0	7.0			9.0			9.0			6.0	
Pedestrian Calls (#/hr)	0	0			0			0			0	
Act Effect Green (s)		19.4		23.3	23.3		15.3	10.0		25.2	21.3	
Actuated g/C Ratio		0.32		0.39	0.39		0.26	0.17		0.42	0.36	

Lanes, Volumes, Timings
 17: Raleigh Street & E. Cameron Avenue/Country Club Road

2022 Build Alternative 1 AM Peak
 Timing Plan: AM Peak



Lane Group	EBL	EBT	EBR	WBL	WBT	WBR	NBL	NBT	NBR	SBL	SBT	SBR
v/c Ratio		0.34		0.07	0.73		0.10	0.33		0.63	0.39	
Control Delay		22.5		12.6	24.8		14.4	31.5		21.2	21.6	
Queue Delay		0.0		0.0	0.0		0.0	0.0		0.0	0.0	
Total Delay		22.5		12.6	24.8		14.4	31.5		21.2	21.6	
LOS		C		B	C		B	C		C	C	
Approach Delay		22.5			23.9			26.8			21.4	
Approach LOS		C			C			C			C	
Queue Length 50th (ft)		35		8	132		6	27		75	46	
Queue Length 95th (ft)		79		23	227		22	67		#212	162	
Internal Link Dist (ft)		518			571			329			915	
Turn Bay Length (ft)				150			125			75		
Base Capacity (vph)		941		568	1391		528	818		564	853	
Starvation Cap Reductn		0		0	0		0	0		0	0	
Spillback Cap Reductn		0		0	0		0	0		0	0	
Storage Cap Reductn		0		0	0		0	0		0	0	
Reduced v/c Ratio		0.15		0.06	0.30		0.06	0.10		0.56	0.24	

Intersection Summary

Area Type: CBD
 Cycle Length: 125
 Actuated Cycle Length: 59.8
 Natural Cycle: 65
 Control Type: Actuated-Uncoordinated
 Maximum v/c Ratio: 0.73
 Intersection Signal Delay: 22.9
 Intersection LOS: C
 Intersection Capacity Utilization 61.6%
 ICU Level of Service B
 Analysis Period (min) 15
 # 95th percentile volume exceeds capacity, queue may be longer.
 Queue shown is maximum after two cycles.

Splits and Phases: 17: Raleigh Street & E. Cameron Avenue/Country Club Road



Lanes, Volumes, Timings
1: Church Street & W. Rosemary Street

2022 Build Alternative 1 Noon Peak

Timing Plan: Noon Peak



Lane Group	EBL	EBT	EBR	WBL	WBT	WBR	NBL	NBT	NBR	SBL	SBT	SBR
Lane Configurations		↕			↕			↕			↕	
Traffic Volume (vph)	6	323	29	44	352	24	23	42	57	14	33	10
Future Volume (vph)	6	323	29	44	352	24	23	42	57	14	33	10
Ideal Flow (vphpl)	1900	1900	1900	1900	1900	1900	1900	1900	1900	1900	1900	1900
Lane Width (ft)	12	14	12	12	14	12	12	12	12	12	12	12
Grade (%)		1%			-1%			0%			0%	
Lane Util. Factor	1.00	1.00	1.00	1.00	1.00	1.00	1.00	1.00	1.00	1.00	1.00	1.00
Ped Bike Factor		0.99			0.99			0.92			0.95	
Frt		0.989			0.992			0.937			0.976	
Flt Protected		0.999			0.995			0.991			0.988	
Satd. Flow (prot)	0	1709	0	0	1748	0	0	1478	0	0	1562	0
Flt Permitted		0.994			0.934			0.922			0.919	
Satd. Flow (perm)	0	1700	0	0	1634	0	0	1335	0	0	1428	0
Right Turn on Red			No			No			No			No
Satd. Flow (RTOR)												
Link Speed (mph)		20			20			25			25	
Link Distance (ft)		964			757			379			430	
Travel Time (s)		32.9			25.8			10.3			11.7	
Confl. Peds. (#/hr)	22		24	24		22	75		39	39		75
Peak Hour Factor	0.88	0.88	0.88	0.93	0.93	0.93	0.92	0.92	0.92	0.64	0.64	0.64
Heavy Vehicles (%)	4%	4%	4%	3%	3%	3%	2%	2%	2%	2%	2%	2%
Adj. Flow (vph)	7	367	33	47	378	26	25	46	62	22	52	16
Shared Lane Traffic (%)												
Lane Group Flow (vph)	0	407	0	0	451	0	0	133	0	0	90	0
Turn Type	Perm	NA		Perm	NA		Perm	NA		Perm	NA	
Protected Phases		2			6			8			4	
Permitted Phases	2			6			8			4		
Detector Phase	2	2		6	6		8	8		4	4	
Switch Phase												
Minimum Initial (s)	10.0	10.0		10.0	10.0		7.0	7.0		7.0	7.0	
Minimum Split (s)	19.0	19.0		20.0	20.0		19.0	19.0		19.0	19.0	
Total Split (s)	43.0	43.0		43.0	43.0		22.0	22.0		22.0	22.0	
Total Split (%)	66.2%	66.2%		66.2%	66.2%		33.8%	33.8%		33.8%	33.8%	
Maximum Green (s)	38.5	38.5		38.4	38.4		17.1	17.1		17.1	17.1	
Yellow Time (s)	3.1	3.1		3.1	3.1		3.2	3.2		3.2	3.2	
All-Red Time (s)	1.4	1.4		1.5	1.5		1.7	1.7		1.7	1.7	
Lost Time Adjust (s)		0.5			0.4			0.1			0.1	
Total Lost Time (s)		5.0			5.0			5.0			5.0	
Lead/Lag												
Lead-Lag Optimize?												
Vehicle Extension (s)	3.0	3.0		3.0	3.0		3.0	3.0		3.0	3.0	
Recall Mode	C-Max	C-Max		C-Max	C-Max		None	None		None	None	
Walk Time (s)	4.0	4.0		4.0	4.0		4.0	4.0		4.0	4.0	
Flash Dont Walk (s)	5.0	5.0		6.0	6.0		10.0	10.0		10.0	10.0	
Pedestrian Calls (#/hr)	0	0		0	0		0	0		0	0	
Act Effct Green (s)		46.8			46.8			11.6			11.6	
Actuated g/C Ratio		0.72			0.72			0.18			0.18	
v/c Ratio		0.33			0.38			0.56			0.35	
Control Delay		6.1			2.6			31.9			26.0	

Lanes, Volumes, Timings
 1: Church Street & W. Rosemary Street

2022 Build Alternative 1 Noon Peak
 Timing Plan: Noon Peak



Lane Group	EBL	EBT	EBR	WBL	WBT	WBR	NBL	NBT	NBR	SBL	SBT	SBR
Queue Delay		0.0			0.0			0.0			0.0	
Total Delay		6.1			2.6			31.9			26.0	
LOS		A			A			C			C	
Approach Delay		6.1			2.6			31.9			26.0	
Approach LOS		A			A			C			C	
Queue Length 50th (ft)		58			22			49			32	
Queue Length 95th (ft)		124			m41			66			43	
Internal Link Dist (ft)		884			677			299			350	
Turn Bay Length (ft)												
Base Capacity (vph)		1223			1176			349			373	
Starvation Cap Reductn		0			0			0			0	
Spillback Cap Reductn		0			0			0			0	
Storage Cap Reductn		0			0			0			0	
Reduced v/c Ratio		0.33			0.38			0.38			0.24	

Intersection Summary

Area Type: CBD
 Cycle Length: 65
 Actuated Cycle Length: 65
 Offset: 23 (35%), Referenced to phase 2:EBTL and 6:WBTL, Start of Green
 Natural Cycle: 40
 Control Type: Actuated-Coordinated
 Maximum v/c Ratio: 0.56
 Intersection Signal Delay: 9.5
 Intersection Capacity Utilization 70.4%
 Analysis Period (min) 15
 Intersection LOS: A
 ICU Level of Service C

m Volume for 95th percentile queue is metered by upstream signal.

Splits and Phases: 1: Church Street & W. Rosemary Street



Lanes, Volumes, Timings

2022 Build Alternative 1 Noon Peak

2: NC 86 (N. Columbia St) & W. Rosemary Street/E. Rosemary Street

Timing Plan: Noon Peak

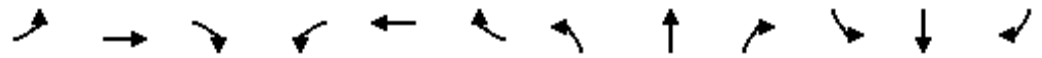

Lane Group	EBL	EBT	EBR	WBL	WBT	WBR	NBL	NBT	NBR	SBL	SBT	SBR
Lane Configurations												
Traffic Volume (vph)	155	202	48	60	215	78	44	315	127	100	356	178
Future Volume (vph)	155	202	48	60	215	78	44	315	127	100	356	178
Ideal Flow (vphpl)	1900	1900	1900	1900	1900	1900	1900	1900	1900	1900	1900	1900
Lane Width (ft)	9	12	13	12	12	12	9	10	12	12	9	11
Grade (%)		1%			1%			-2%			8%	
Storage Length (ft)	100		0	75		0	75		0	150		400
Storage Lanes	1		0	1		0	1		0	1		1
Taper Length (ft)	25			25			25			25		
Lane Util. Factor	1.00	1.00	1.00	1.00	1.00	1.00	1.00	0.95	0.95	1.00	0.95	1.00
Ped Bike Factor	0.97	0.99		0.96	0.98		0.85	0.85		0.80		0.66
Frt		0.971			0.960			0.957				0.850
Flt Protected	0.950			0.950			0.950			0.950		
Satd. Flow (prot)	1426	1596	0	1585	1563	0	1355	2299	0	1485	2673	1285
Flt Permitted	0.222			0.585			0.468			0.397		
Satd. Flow (perm)	323	1596	0	934	1563	0	570	2299	0	494	2673	850
Right Turn on Red			No			No			No			No
Satd. Flow (RTOR)												
Link Speed (mph)		20			20			25			25	
Link Distance (ft)		757			266			353			476	
Travel Time (s)		25.8			9.1			9.6			13.0	
Confl. Peds. (#/hr)	53		41	41		53	80		129	129		80
Peak Hour Factor	0.88	0.88	0.88	0.85	0.85	0.85	0.98	0.98	0.98	0.86	0.86	0.86
Heavy Vehicles (%)	2%	2%	2%	2%	2%	2%	9%	9%	9%	5%	5%	5%
Adj. Flow (vph)	176	230	55	71	253	92	45	321	130	116	414	207
Shared Lane Traffic (%)												
Lane Group Flow (vph)	176	285	0	71	345	0	45	451	0	116	414	207
Turn Type	pm+pt	NA		Perm	NA		pm+pt	NA		pm+pt	NA	pm+ov
Protected Phases	7	4			8		5	2		1	6	7
Permitted Phases	4			8			2			6		6
Detector Phase	7	4		8	8		5	2		1	6	7
Switch Phase												
Minimum Initial (s)	7.0	7.0		7.0	7.0		7.0	10.0		7.0	10.0	7.0
Minimum Split (s)	13.0	31.0		32.0	32.0		13.0	23.0		13.0	22.0	13.0
Total Split (s)	43.0	63.0		20.0	20.0		15.0	52.0		15.0	52.0	43.0
Total Split (%)	33.1%	48.5%		15.4%	15.4%		11.5%	40.0%		11.5%	40.0%	33.1%
Maximum Green (s)	37.2	57.0		14.0	14.0		9.2	46.2		9.9	46.2	37.2
Yellow Time (s)	3.0	3.2		3.2	3.2		3.0	3.3		3.0	3.3	3.0
All-Red Time (s)	2.8	2.8		2.8	2.8		2.8	2.5		2.1	2.5	2.8
Lost Time Adjust (s)	-0.8	-1.0		-1.0	-1.0		0.0	-0.8		-0.1	-0.8	-0.8
Total Lost Time (s)	5.0	5.0		5.0	5.0		5.8	5.0		5.0	5.0	5.0
Lead/Lag	Lead			Lag	Lag		Lead	Lag		Lead	Lag	Lead
Lead-Lag Optimize?												
Vehicle Extension (s)	1.0	1.0		1.0	1.0		1.0	3.0		1.0	3.0	1.0
Recall Mode	None	None		None	None		None	C-Max		None	C-Max	None
Walk Time (s)		7.0		7.0	7.0			7.0			7.0	
Flash Dont Walk (s)		18.0		19.0	19.0			10.0			9.0	
Pedestrian Calls (#/hr)		0		0	0			0			0	
Act Effect Green (s)	58.0	58.0		33.4	33.4		54.6	48.2		58.9	51.5	71.1

Lanes, Volumes, Timings

2022 Build Alternative 1 Noon Peak

2: NC 86 (N. Columbia St) & W. Rosemary Street/E. Rosemary Street

Timing Plan: Noon Peak

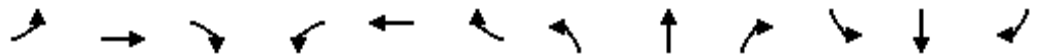

Lane Group	EBL	EBT	EBR	WBL	WBT	WBR	NBL	NBT	NBR	SBL	SBT	SBR
Actuated g/C Ratio	0.45	0.45		0.26	0.26		0.42	0.37		0.45	0.40	0.55
v/c Ratio	0.57	0.40		0.30	0.86		0.16	0.53		0.40	0.39	0.39
Control Delay	31.0	27.4		43.1	65.4		16.4	20.7		23.7	30.3	17.4
Queue Delay	0.0	0.0		0.0	0.0		0.0	0.7		0.0	0.0	0.0
Total Delay	31.0	27.4		43.1	65.4		16.4	21.4		23.7	30.3	17.4
LOS	C	C		D	E		B	C		C	C	B
Approach Delay		28.8			61.6			21.0			25.7	
Approach LOS		C			E			C			C	
Queue Length 50th (ft)	92	184		43	257		10	55		54	134	86
Queue Length 95th (ft)	122	232		92	#477		m27	124		88	174	112
Internal Link Dist (ft)		677			186			273			396	
Turn Bay Length (ft)	100			75			75			150		400
Base Capacity (vph)	466	712		239	402		303	852		302	1058	712
Starvation Cap Reductn	0	0		0	0		0	153		0	0	0
Spillback Cap Reductn	0	0		0	0		0	0		0	4	0
Storage Cap Reductn	0	0		0	0		0	0		0	0	0
Reduced v/c Ratio	0.38	0.40		0.30	0.86		0.15	0.65		0.38	0.39	0.29

Intersection Summary

Area Type: CBD
 Cycle Length: 130
 Actuated Cycle Length: 130
 Offset: 55 (42%), Referenced to phase 2:NBTL and 6:SBTL, Start of Green
 Natural Cycle: 85
 Control Type: Actuated-Coordinated
 Maximum v/c Ratio: 0.86
 Intersection Signal Delay: 32.3 Intersection LOS: C
 Intersection Capacity Utilization 69.7% ICU Level of Service C
 Analysis Period (min) 15
 # 95th percentile volume exceeds capacity, queue may be longer.
 Queue shown is maximum after two cycles.
 m Volume for 95th percentile queue is metered by upstream signal.

Splits and Phases: 2: NC 86 (N. Columbia St) & W. Rosemary Street/E. Rosemary Street

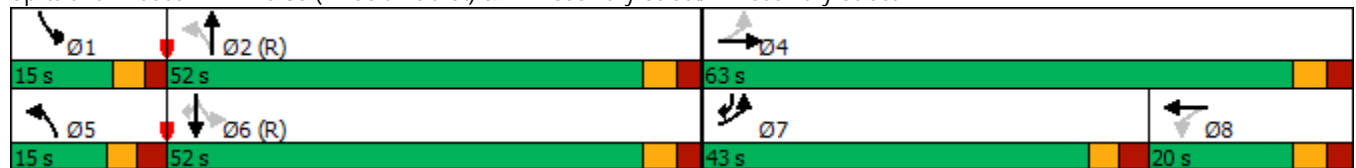

Lanes, Volumes, Timings
6: Henderson Street & E. Rosemary Street

2022 Build Alternative 1 Noon Peak
Timing Plan: Noon Peak



Lane Group	EBL	EBT	EBR	WBL	WBT	WBR	NBL	NBT	NBR	SBL	SBT	SBR
Lane Configurations												
Traffic Volume (vph)	15	190	130	15	204	31	55	30	11	9	30	13
Future Volume (vph)	15	190	130	15	204	31	55	30	11	9	30	13
Ideal Flow (vphpl)	1900	1900	1900	1900	1900	1900	1900	1900	1900	1900	1900	1900
Grade (%)		0%			0%			0%			3%	
Storage Length (ft)	85		0	0		0	0		0	0		0
Storage Lanes	1		0	0		0	0		0	0		0
Taper Length (ft)	25			25			25			25		
Lane Util. Factor	1.00	1.00	1.00	1.00	1.00	1.00	1.00	1.00	1.00	1.00	1.00	1.00
Ped Bike Factor	0.96	0.97			0.99			0.85			0.92	
Frt		0.939			0.983			0.985			0.967	
Flt Protected	0.950				0.997			0.972			0.991	
Satd. Flow (prot)	1593	1526	0	0	1626	0	0	1580	0	0	1474	0
Flt Permitted	0.596				0.976			0.788			0.933	
Satd. Flow (perm)	961	1526	0	0	1589	0	0	1102	0	0	1365	0
Right Turn on Red			No			No			No			No
Satd. Flow (RTOR)												
Link Speed (mph)		20			20			20			20	
Link Distance (ft)		500			1195			366			450	
Travel Time (s)		17.0			40.7			12.5			15.3	
Confl. Peds. (#/hr)	21		19	19		21	106		47	47		106
Peak Hour Factor	0.96	0.96	0.96	0.95	0.95	0.95	0.68	0.68	0.68	0.85	0.85	0.85
Adj. Flow (vph)	16	198	135	16	215	33	81	44	16	11	35	15
Shared Lane Traffic (%)												
Lane Group Flow (vph)	16	333	0	0	264	0	0	141	0	0	61	0
Turn Type	Perm	NA		Perm	NA		Perm	NA		Perm	NA	
Protected Phases		2			2			4			4	
Permitted Phases	2			2			4			4		
Detector Phase	2	2		2	2		4	4		4	4	
Switch Phase												
Minimum Initial (s)	11.0	11.0		11.0	11.0		8.0	8.0		8.0	8.0	
Minimum Split (s)	15.9	15.9		15.9	15.9		17.8	17.8		17.8	17.8	
Total Split (s)	38.0	38.0		38.0	38.0		27.0	27.0		27.0	27.0	
Total Split (%)	58.5%	58.5%		58.5%	58.5%		41.5%	41.5%		41.5%	41.5%	
Maximum Green (s)	33.1	33.1		33.1	33.1		22.2	22.2		22.2	22.2	
Yellow Time (s)	3.3	3.3		3.3	3.3		3.3	3.3		3.3	3.3	
All-Red Time (s)	1.6	1.6		1.6	1.6		1.5	1.5		1.5	1.5	
Lost Time Adjust (s)	0.1	0.1			0.1			0.2			0.2	
Total Lost Time (s)	5.0	5.0			5.0			5.0			5.0	
Lead/Lag												
Lead-Lag Optimize?												
Vehicle Extension (s)	2.0	2.0		2.0	2.0		2.0	2.0		2.0	2.0	
Recall Mode	C-Max	C-Max		C-Max	C-Max		None	None		None	None	
Walk Time (s)	4.0	4.0		4.0	4.0		4.0	4.0		4.0	4.0	
Flash Dont Walk (s)	7.0	7.0		7.0	7.0		9.0	9.0		9.0	9.0	
Pedestrian Calls (#/hr)	0	0		0	0		0	0		0	0	
Act Effct Green (s)	45.9	45.9			45.9			12.6			12.6	
Actuated g/C Ratio	0.71	0.71			0.71			0.19			0.19	
v/c Ratio	0.02	0.31			0.24			0.66			0.23	

Lanes, Volumes, Timings
 6: Henderson Street & E. Rosemary Street

2022 Build Alternative 1 Noon Peak
 Timing Plan: Noon Peak



Lane Group	EBL	EBT	EBR	WBL	WBT	WBR	NBL	NBT	NBR	SBL	SBT	SBR
Control Delay	5.3	5.5			6.0			35.4			22.4	
Queue Delay	0.0	0.0			0.0			0.0			0.0	
Total Delay	5.3	5.5			6.0			35.4			22.4	
LOS	A	A			A			D			C	
Approach Delay		5.5			6.0			35.4			22.4	
Approach LOS		A			A			D			C	
Queue Length 50th (ft)	2	50			57			62			21	
Queue Length 95th (ft)	m7	103			105			66			41	
Internal Link Dist (ft)		420			1115			286			370	
Turn Bay Length (ft)	85											
Base Capacity (vph)	679	1078			1122			372			462	
Starvation Cap Reductn	0	0			0			0			0	
Spillback Cap Reductn	0	0			0			0			0	
Storage Cap Reductn	0	0			0			0			0	
Reduced v/c Ratio	0.02	0.31			0.24			0.38			0.13	

Intersection Summary

Area Type: CBD
 Cycle Length: 65
 Actuated Cycle Length: 65
 Offset: 63 (97%), Referenced to phase 2:EBWB, Start of Green
 Natural Cycle: 40
 Control Type: Actuated-Coordinated
 Maximum v/c Ratio: 0.66
 Intersection Signal Delay: 12.1
 Intersection LOS: B
 Intersection Capacity Utilization 49.5%
 ICU Level of Service A
 Analysis Period (min) 15
 m Volume for 95th percentile queue is metered by upstream signal.

Splits and Phases: 6: Henderson Street & E. Rosemary Street



Lanes, Volumes, Timings
7: Hillsborough Street & E. Rosemary Street

2022 Build Alternative 1 Noon Peak
Timing Plan: Noon Peak



Lane Group	EBL	EBT	EBR	WBL	WBT	WBR	NBL	NBT	NBR	SBL	SBT	SBR
Lane Configurations		↕			↕		↗	↘		↗	↘	
Traffic Volume (vph)	23	90	85	3	51	9	162	179	9	16	218	25
Future Volume (vph)	23	90	85	3	51	9	162	179	9	16	218	25
Ideal Flow (vphp)	1900	1900	1900	1900	1900	1900	1900	1900	1900	1900	1900	1900
Storage Length (ft)	0		0	0		0	100		0	100		0
Storage Lanes	0		0	0		0	1		0	1		0
Taper Length (ft)	25			25			25			25		
Lane Util. Factor	1.00	1.00	1.00	1.00	1.00	1.00	1.00	1.00	1.00	1.00	1.00	1.00
Ped Bike Factor		0.95			0.98		0.93	1.00		0.99	0.98	
Frt		0.942			0.980			0.993			0.985	
Flt Protected		0.994			0.998		0.950			0.950		
Satd. Flow (prot)	0	1674	0	0	1791	0	1770	1847	0	1719	1750	0
Flt Permitted		0.956			0.982		0.489			0.625		
Satd. Flow (perm)	0	1594	0	0	1758	0	846	1847	0	1117	1750	0
Right Turn on Red			No			No			No			No
Satd. Flow (RTOR)												
Link Speed (mph)		20			20			25			25	
Link Distance (ft)		1195			527			363			726	
Travel Time (s)		40.7			18.0			9.9			19.8	
Confl. Peds. (#/hr)	35		35	35		35	50		5	5		50
Peak Hour Factor	0.93	0.93	0.93	0.78	0.78	0.78	0.88	0.88	0.88	0.91	0.91	0.91
Heavy Vehicles (%)	2%	2%	2%	2%	2%	2%	2%	2%	2%	5%	5%	5%
Adj. Flow (vph)	25	97	91	4	65	12	184	203	10	18	240	27
Shared Lane Traffic (%)												
Lane Group Flow (vph)	0	213	0	0	81	0	184	213	0	18	267	0
Turn Type	Perm	NA		Perm	NA		pm+pt	NA		Perm	NA	
Protected Phases		4			8		5	2			6	
Permitted Phases	4			8			2			6		
Detector Phase	4	4		8	8		5	2		6	6	
Switch Phase												
Minimum Initial (s)	7.0	7.0		7.0	7.0		7.0	10.0		10.0	10.0	
Minimum Split (s)	20.0	20.0		17.0	17.0		12.0	15.0		15.0	15.0	
Total Split (s)	24.0	24.0		24.0	24.0		13.0	41.0		28.0	28.0	
Total Split (%)	36.9%	36.9%		36.9%	36.9%		20.0%	63.1%		43.1%	43.1%	
Maximum Green (s)	19.1	19.1		19.0	19.0		8.2	36.2		23.2	23.2	
Yellow Time (s)	3.0	3.0		3.3	3.3		3.0	3.3		3.1	3.1	
All-Red Time (s)	1.9	1.9		1.7	1.7		1.8	1.5		1.7	1.7	
Lost Time Adjust (s)		0.1			0.0		0.2	0.2		0.2	0.2	
Total Lost Time (s)		5.0			5.0		5.0	5.0		5.0	5.0	
Lead/Lag							Lead			Lag	Lag	
Lead-Lag Optimize?												
Vehicle Extension (s)	2.0	2.0		2.0	2.0		2.0	2.0		2.0	2.0	
Recall Mode	None	None		None	None		None	C-Max		C-Max	C-Max	
Walk Time (s)	4.0	4.0		4.0	4.0			4.0		4.0	4.0	
Flash Dont Walk (s)	11.0	11.0		8.0	8.0			6.0		6.0	6.0	
Pedestrian Calls (#/hr)	0	0		0	0			0		0	0	
Act Effct Green (s)		12.8			12.8		42.2	42.2		29.7	29.7	
Actuated g/C Ratio		0.20			0.20		0.65	0.65		0.46	0.46	
v/c Ratio		0.68			0.23		0.28	0.18		0.04	0.33	

Lanes, Volumes, Timings
7: Hillsborough Street & E. Rosemary Street

2022 Build Alternative 1 Noon Peak

Timing Plan: Noon Peak



Lane Group	EBL	EBT	EBR	WBL	WBT	WBR	NBL	NBT	NBR	SBL	SBT	SBR
Control Delay		31.8			21.9		6.3	5.7		12.8	14.4	
Queue Delay		0.0			0.0		0.0	0.0		0.0	0.0	
Total Delay		31.8			21.9		6.3	5.7		12.8	14.4	
LOS		C			C		A	A		B	B	
Approach Delay		31.8			21.9			6.0			14.3	
Approach LOS		C			C			A			B	
Queue Length 50th (ft)		77			27		49	57		4	63	
Queue Length 95th (ft)		104			46		71	83		17	138	
Internal Link Dist (ft)		1115			447			283			646	
Turn Bay Length (ft)							100			100		
Base Capacity (vph)		465			513		665	1198		510	799	
Starvation Cap Reductn		0			0		0	0		0	0	
Spillback Cap Reductn		0			0		0	0		0	0	
Storage Cap Reductn		0			0		0	0		0	0	
Reduced v/c Ratio		0.46			0.16		0.28	0.18		0.04	0.33	

Intersection Summary

Area Type:	Other
Cycle Length:	65
Actuated Cycle Length:	65
Offset:	19 (29%), Referenced to phase 2:NBTL and 6:SBTL, Start of Green
Natural Cycle:	50
Control Type:	Actuated-Coordinated
Maximum v/c Ratio:	0.68
Intersection Signal Delay:	15.4
Intersection LOS:	B
Intersection Capacity Utilization	54.1%
ICU Level of Service	A
Analysis Period (min)	15

Splits and Phases: 7: Hillsborough Street & E. Rosemary Street

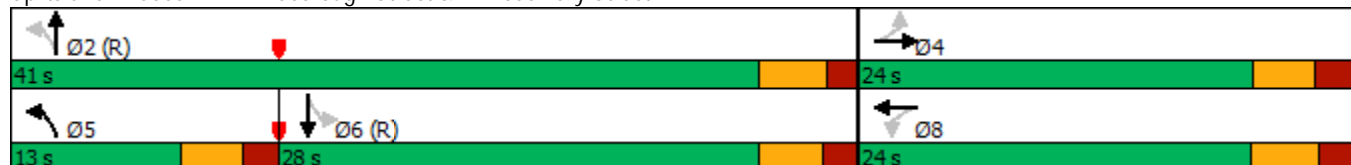

Lanes, Volumes, Timings

2022 Build Alternative 1 Noon Peak

8: Carolina Square Driveway/Church Street & W. Franklin Street

Timing Plan: Noon Peak



Lane Group	EBL	EBT	EBR	WBL	WBT	WBR	NBL	NBT	NBR	SBL	SBT	SBR
Lane Configurations												
Traffic Volume (vph)	52	360	26	32	331	68	10	10	22	23	23	57
Future Volume (vph)	52	360	26	32	331	68	10	10	22	23	23	57
Ideal Flow (vphpl)	1900	1900	1900	1900	1900	1900	1900	1900	1900	1900	1900	1900
Lane Width (ft)	10	10	16	10	10	10	12	12	12	12	12	12
Grade (%)		2%			-2%			-4%				-3%
Storage Length (ft)	150		0	200		0	0		100	0		0
Storage Lanes	1		0	1		0	0		1	0		0
Taper Length (ft)	25			25			25			25		
Lane Util. Factor	1.00	1.00	1.00	1.00	1.00	1.00	1.00	1.00	1.00	1.00	1.00	1.00
Ped Bike Factor	0.84	0.97		0.78	0.93			0.86	0.87		0.78	
Frt		0.990			0.974				0.850		0.925	
Flt Protected	0.950			0.950				0.976			0.989	
Satd. Flow (prot)	1443	1452	0	1472	1410	0	0	1669	1454	0	1209	0
Flt Permitted	0.481			0.477				0.827			0.925	
Satd. Flow (perm)	616	1452	0	578	1410	0	0	1219	1262	0	1103	0
Right Turn on Red			No			No			No			No
Satd. Flow (RTOR)												
Link Speed (mph)		20			20			20			25	
Link Distance (ft)		993			298			285			379	
Travel Time (s)		33.9			10.2			9.7			10.3	
Confl. Peds. (#/hr)	150		248	248		150	225		77	77		225
Peak Hour Factor	0.87	0.87	0.87	0.91	0.91	0.91	0.81	0.81	0.81	0.71	0.71	0.71
Heavy Vehicles (%)	4%	4%	4%	4%	4%	4%	2%	2%	2%	5%	5%	5%
Adj. Flow (vph)	60	414	30	35	364	75	12	12	27	32	32	80
Shared Lane Traffic (%)												
Lane Group Flow (vph)	60	444	0	35	439	0	0	24	27	0	144	0
Turn Type	Perm	NA		Perm	NA		Perm	NA	Perm	Perm	NA	
Protected Phases		2			6			8				4
Permitted Phases	2			6			8		8	4		
Detector Phase	2	2		6	6		8	8	8	4	4	
Switch Phase												
Minimum Initial (s)	10.0	10.0		10.0	10.0		7.0	7.0	7.0	7.0	7.0	
Minimum Split (s)	22.0	22.0		19.0	19.0		29.0	29.0	29.0	27.0	27.0	
Total Split (s)	36.0	36.0		36.0	36.0		29.0	29.0	29.0	29.0	29.0	
Total Split (%)	55.4%	55.4%		55.4%	55.4%		44.6%	44.6%	44.6%	44.6%	44.6%	
Maximum Green (s)	30.4	30.4		30.4	30.4		22.7	22.7	22.7	23.0	23.0	
Yellow Time (s)	3.3	3.3		3.3	3.3		3.1	3.1	3.1	3.4	3.4	
All-Red Time (s)	2.3	2.3		2.3	2.3		3.2	3.2	3.2	2.6	2.6	
Lost Time Adjust (s)	-0.6	-0.6		-0.6	-0.6		-1.3	-1.3	-1.3	-1.0	-1.0	
Total Lost Time (s)	5.0	5.0		5.0	5.0		5.0	5.0	5.0	5.0	5.0	
Lead/Lag												
Lead-Lag Optimize?												
Vehicle Extension (s)	3.0	3.0		3.0	3.0		2.0	2.0	2.0	2.0	2.0	
Recall Mode	C-Max	C-Max		C-Max	C-Max		None	None	None	None	None	
Walk Time (s)	7.0	7.0		7.0	7.0		7.0	7.0	7.0	7.0	7.0	
Flash Dont Walk (s)	9.0	9.0		6.0	6.0		15.0	15.0	15.0	14.0	14.0	
Pedestrian Calls (#/hr)	0	0		0	0		0	0	0	0	0	
Act Effect Green (s)	44.7	44.7		44.7	44.7		14.0	14.0	14.0	13.9	13.9	

Lanes, Volumes, Timings
 8: Carolina Square Driveway/Church Street & W. Franklin Street

2022 Build Alternative 1 Noon Peak

Timing Plan: Noon Peak



Lane Group	EBL	EBT	EBR	WBL	WBT	WBR	NBL	NBT	NBR	SBL	SBT	SBR
Actuated g/C Ratio	0.69	0.69		0.69	0.69			0.22	0.22			0.21
v/c Ratio	0.14	0.44		0.09	0.45			0.09	0.10			0.61
Control Delay	7.6	9.1		8.2	10.2			18.6	18.8			32.5
Queue Delay	0.0	0.0		0.0	0.0			0.0	0.0			0.0
Total Delay	7.6	9.1		8.2	10.2			18.6	18.8			32.5
LOS	A	A		A	B			B	B			C
Approach Delay		8.9			10.0			18.7				32.5
Approach LOS		A			B			B				C
Queue Length 50th (ft)	8	79		3	50			8	9			63
Queue Length 95th (ft)	29	178		m28	321			19	21			64
Internal Link Dist (ft)		913			218			205				299
Turn Bay Length (ft)	150			200					100			
Base Capacity (vph)	423	998		397	969			450	465			407
Starvation Cap Reductn	0	0		0	0			0	0			0
Spillback Cap Reductn	0	0		0	0			0	0			0
Storage Cap Reductn	0	0		0	0			0	0			0
Reduced v/c Ratio	0.14	0.44		0.09	0.45			0.05	0.06			0.35

Intersection Summary

Area Type: CBD
 Cycle Length: 65
 Actuated Cycle Length: 65
 Offset: 2 (3%), Referenced to phase 2:EBTL and 6:WBTL, Start of Green
 Natural Cycle: 60
 Control Type: Actuated-Coordinated
 Maximum v/c Ratio: 0.61
 Intersection Signal Delay: 12.7 Intersection LOS: B
 Intersection Capacity Utilization 70.8% ICU Level of Service C
 Analysis Period (min) 15
 m Volume for 95th percentile queue is metered by upstream signal.

Splits and Phases: 8: Carolina Square Driveway/Church Street & W. Franklin Street



Lanes, Volumes, Timings

2022 Build Alternative 1 Noon Peak

9: NC 86 (S. Columbia St)/NC 86 (N. Columbia St) & W. Franklin Street/E. Franklin Street

Lane Group	EBL	EBT	EBR	WBL	WBT	WBR	NBL	NBT	NBR	SBL	SBT	SBR
Lane Configurations												
Traffic Volume (vph)	104	298	46	82	308	87	61	303	90	50	318	89
Future Volume (vph)	104	298	46	82	308	87	61	303	90	50	318	89
Ideal Flow (vphpl)	1900	1900	1900	1900	1900	1900	1900	1900	1900	1900	1900	1900
Lane Width (ft)	9	12	13	10	10	13	9	10	10	9	9	11
Grade (%)		3%			1%			-2%				3%
Storage Length (ft)	250		0	125		0	475		0	125		0
Storage Lanes	1		0	1		1	1		0	1		0
Taper Length (ft)	25			25			25			25		
Lane Util. Factor	1.00	0.95	0.95	1.00	1.00	1.00	1.00	0.95	0.95	1.00	0.95	0.95
Ped Bike Factor	0.80	0.96		0.82		0.67	0.82	0.92		0.80	0.92	
Frt		0.980				0.850		0.966			0.967	
Flt Protected	0.950			0.950			0.950			0.950		
Satd. Flow (prot)	1372	2853	0	1437	1512	1423	1342	2468	0	1346	2398	0
Flt Permitted	0.950			0.950			0.950			0.950		
Satd. Flow (perm)	1096	2853	0	1178	1512	947	1104	2468	0	1081	2398	0
Right Turn on Red			No			No			No			No
Satd. Flow (RTOR)												
Link Speed (mph)		20			20			25				25
Link Distance (ft)		457			941			981				353
Travel Time (s)		15.6			32.1			26.8				9.6
Confl. Peds. (#/hr)	251		248	248		251	117		321	321		117
Peak Hour Factor	0.80	0.80	0.80	0.87	0.87	0.87	0.93	0.93	0.93	0.85	0.85	0.85
Heavy Vehicles (%)	5%	5%	5%	5%	5%	5%	10%	10%	10%	7%	7%	7%
Adj. Flow (vph)	130	373	58	94	354	100	66	326	97	59	374	105
Shared Lane Traffic (%)												
Lane Group Flow (vph)	130	431	0	94	354	100	66	423	0	59	479	0
Turn Type	Prot	NA		Prot	NA	pm+ov	Prot	NA		Prot	NA	
Protected Phases	5	2		1	6	7	3	8		7	4	
Permitted Phases						6						
Detector Phase	5	2		1	6	7	3	8		7	4	
Switch Phase												
Minimum Initial (s)	7.0	10.0		7.0	10.0	7.0	7.0	7.0		7.0	7.0	
Minimum Split (s)	15.0	28.2		15.0	28.2	15.0	15.0	28.0		15.0	28.1	
Total Split (s)	25.0	32.0		25.0	32.0	25.0	25.0	48.0		25.0	48.0	
Total Split (%)	19.2%	24.6%		19.2%	24.6%	19.2%	19.2%	36.9%		19.2%	36.9%	
Maximum Green (s)	19.6	25.8		19.1	25.8	19.1	19.1	42.1		19.1	42.3	
Yellow Time (s)	3.0	3.0		3.0	3.0	3.0	3.0	3.3		3.0	3.1	
All-Red Time (s)	2.4	3.2		2.9	3.2	2.9	2.9	2.6		2.9	2.6	
Lost Time Adjust (s)	-0.4	-1.2		-0.9	-1.2	-2.0	-0.9	-0.9		-0.9	-0.7	
Total Lost Time (s)	5.0	5.0		5.0	5.0	3.9	5.0	5.0		5.0	5.0	
Lead/Lag	Lead	Lag		Lead	Lag	Lead	Lead	Lag		Lead	Lag	
Lead-Lag Optimize?												
Vehicle Extension (s)	1.0	3.0		1.0	3.0	1.0	1.0	2.0		1.0	2.0	
Recall Mode	None	C-Max		None	C-Max	None	None	Ped		None	Ped	
Walk Time (s)		7.0			7.0			7.0			7.0	
Flash Dont Walk (s)		15.0			15.0			15.0			15.0	
Pedestrian Calls (#/hr)		0			0			0			0	
Act Effect Green (s)	16.1	54.5		13.0	51.4	64.2	11.2	31.9		10.6	33.9	

Lanes, Volumes, Timings

2022 Build Alternative 1 Noon Peak

9: NC 86 (S. Columbia St)/NC 86 (N. Columbia St) & W. Franklin Street/E. Franklin Street



Lane Group	EBL	EBT	EBR	WBL	WBT	WBR	NBL	NBT	NBR	SBL	SBT	SBR
Actuated g/C Ratio	0.12	0.42		0.10	0.40	0.49	0.09	0.25		0.08	0.26	
v/c Ratio	0.77	0.36		0.66	0.59	0.20	0.57	0.70		0.54	0.77	
Control Delay	76.0	32.3		84.2	39.1	13.6	100.2	28.9		90.2	33.8	
Queue Delay	0.0	0.0		0.0	0.0	0.0	0.0	0.0		0.0	0.1	
Total Delay	76.0	32.3		84.2	39.1	13.6	100.2	28.9		90.2	33.8	
LOS	E	C		F	D	B	F	C		F	C	
Approach Delay		42.5			42.2			38.5			40.0	
Approach LOS		D			D			D			D	
Queue Length 50th (ft)	103	128		72	241	31	57	70		52	96	
Queue Length 95th (ft)	139	212		137	#481	68	105	66		94	94	
Internal Link Dist (ft)		377			861			901			273	
Turn Bay Length (ft)	250			125			475			125		
Base Capacity (vph)	218	1196		221	597	613	206	816		207	793	
Starvation Cap Reductn	0	0		0	0	0	0	0		0	13	
Spillback Cap Reductn	0	0		0	0	0	0	0		0	0	
Storage Cap Reductn	0	0		0	0	0	0	0		0	0	
Reduced v/c Ratio	0.60	0.36		0.43	0.59	0.16	0.32	0.52		0.29	0.61	

Intersection Summary

Area Type: CBD
 Cycle Length: 130
 Actuated Cycle Length: 130
 Offset: 0 (0%), Referenced to phase 2:EBT and 6:WBT, Start of Green
 Natural Cycle: 90
 Control Type: Actuated-Coordinated
 Maximum v/c Ratio: 0.77
 Intersection Signal Delay: 40.9
 Intersection LOS: D
 Intersection Capacity Utilization 65.6%
 ICU Level of Service C
 Analysis Period (min) 15

95th percentile volume exceeds capacity, queue may be longer.
 Queue shown is maximum after two cycles.

Splits and Phases: 9: NC 86 (S. Columbia St)/NC 86 (N. Columbia St) & W. Franklin Street/E. Franklin Street

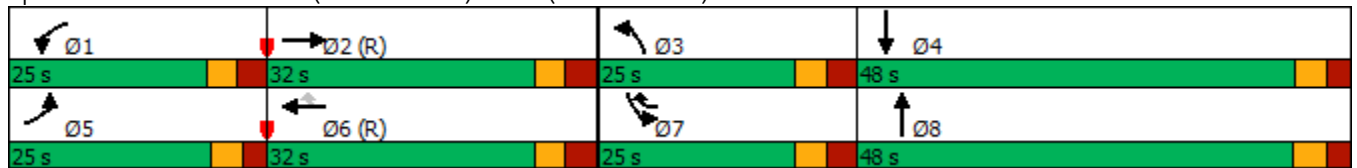

Lanes, Volumes, Timings
 10: E. Franklin Street & Henderson Street

2022 Build Alternative 1 Noon Peak
 Timing Plan: Noon Peak



Lane Group	EBL	EBT	WBT	WBR	SBL	SBR
Lane Configurations		↕↕	↕↔		↔↕	
Traffic Volume (vph)	47	377	415	54	96	80
Future Volume (vph)	47	377	415	54	96	80
Ideal Flow (vphpl)	1900	1900	1900	1900	1900	1900
Lane Width (ft)	10	13	10	10	11	11
Grade (%)		-2%	2%		3%	
Lane Util. Factor	0.95	0.95	0.95	0.95	1.00	1.00
Ped Bike Factor		0.99	0.97		0.79	
Frt			0.983		0.939	
Flt Protected		0.995			0.973	
Satd. Flow (prot)	0	3213	2748	0	1245	0
Flt Permitted		0.862			0.973	
Satd. Flow (perm)	0	2747	2748	0	1154	0
Right Turn on Red				No		No
Satd. Flow (RTOR)						
Link Speed (mph)		20	20		20	
Link Distance (ft)		941	1200		366	
Travel Time (s)		32.1	40.9		12.5	
Confl. Peds. (#/hr)	119			119	130	370
Peak Hour Factor	0.95	0.95	0.92	0.92	0.87	0.87
Heavy Vehicles (%)	5%	5%	4%	4%	2%	2%
Parking (#/hr)						0
Adj. Flow (vph)	49	397	451	59	110	92
Shared Lane Traffic (%)						
Lane Group Flow (vph)	0	446	510	0	202	0
Turn Type	Perm	NA	NA		Prot	
Protected Phases		2	6		4	
Permitted Phases	2					
Detector Phase	2	2	6		4	
Switch Phase						
Minimum Initial (s)	10.0	10.0	10.0		7.0	
Minimum Split (s)	17.0	17.0	22.0		25.0	
Total Split (s)	32.0	32.0	32.0		33.0	
Total Split (%)	49.2%	49.2%	49.2%		50.8%	
Maximum Green (s)	25.8	25.8	25.9		27.9	
Yellow Time (s)	3.0	3.0	3.0		3.0	
All-Red Time (s)	3.2	3.2	3.1		2.1	
Lost Time Adjust (s)		-1.2	-1.1		-0.1	
Total Lost Time (s)		5.0	5.0		5.0	
Lead/Lag						
Lead-Lag Optimize?						
Vehicle Extension (s)	2.0	2.0	2.0		1.0	
Recall Mode	C-Max	C-Max	C-Max		None	
Walk Time (s)			7.0		7.0	
Flash Dont Walk (s)			8.0		12.0	
Pedestrian Calls (#/hr)			0		0	
Act Effct Green (s)		40.5	40.5		14.5	
Actuated g/C Ratio		0.62	0.62		0.22	
v/c Ratio		0.26	0.30		0.73	

Lanes, Volumes, Timings
 10: E. Franklin Street & Henderson Street

2022 Build Alternative 1 Noon Peak
 Timing Plan: Noon Peak



Lane Group	EBL	EBT	WBT	WBR	SBL	SBR
Control Delay		6.6	7.5		36.2	
Queue Delay		0.0	0.0		0.0	
Total Delay		6.6	7.5		36.2	
LOS		A	A		D	
Approach Delay		6.6	7.5		36.2	
Approach LOS		A	A		D	
Queue Length 50th (ft)		15	36		90	
Queue Length 95th (ft)		154	132		119	
Internal Link Dist (ft)		861	1120		286	
Turn Bay Length (ft)						
Base Capacity (vph)		1711	1712		536	
Starvation Cap Reductn		0	0		0	
Spillback Cap Reductn		0	0		0	
Storage Cap Reductn		0	0		0	
Reduced v/c Ratio		0.26	0.30		0.38	

Intersection Summary

Area Type:	CBD
Cycle Length:	65
Actuated Cycle Length:	65
Offset:	4 (6%), Referenced to phase 2:EBTL and 6:WBT, Start of Green
Natural Cycle:	50
Control Type:	Actuated-Coordinated
Maximum v/c Ratio:	0.73
Intersection Signal Delay:	12.2
Intersection LOS:	B
Intersection Capacity Utilization	56.8%
ICU Level of Service	B
Analysis Period (min)	15

Splits and Phases: 10: E. Franklin Street & Henderson Street

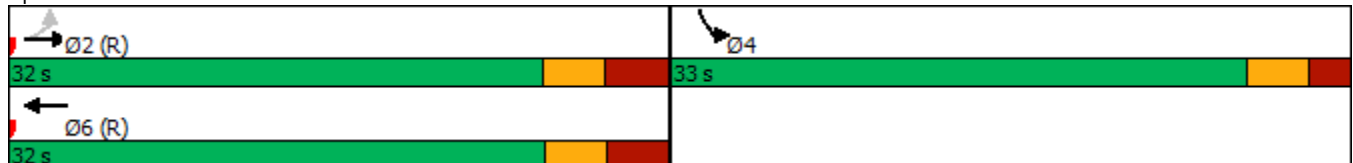

Lanes, Volumes, Timings

2022 Build Alternative 1 Noon Peak

11: Raleigh Street/Hillsborough Street & E. Franklin Street

Timing Plan: Noon Peak

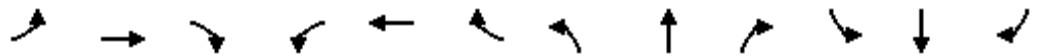

Lane Group	EBL	EBT	EBR	WBL	WBT	WBR	NBL	NBT	NBR	SBL	SBT	SBR
Lane Configurations												
Traffic Volume (vph)	55	331	148	41	370	144	83	160	23	69	194	23
Future Volume (vph)	55	331	148	41	370	144	83	160	23	69	194	23
Ideal Flow (vphpl)	1900	1900	1900	1900	1900	1900	1900	1900	1900	1900	1900	1900
Lane Width (ft)	9	9	10	9	10	11	12	12	12	10	10	10
Grade (%)		1%			-2%			1%			1%	
Storage Length (ft)	75		0	75		0	0		0	100		0
Storage Lanes	1		0	1		0	0		0	1		0
Taper Length (ft)	25			25			25			25		
Lane Util. Factor	1.00	0.95	0.95	1.00	0.95	0.95	1.00	1.00	1.00	1.00	1.00	1.00
Ped Bike Factor	0.98	0.98		0.99	0.98			0.97		0.97	0.98	
Frt		0.954			0.958			0.989			0.984	
Flt Protected	0.950			0.950				0.985		0.950		
Satd. Flow (prot)	1539	2893	0	1593	3096	0	0	1795	0	1612	1638	0
Flt Permitted	0.413			0.433				0.663		0.494		
Satd. Flow (perm)	653	2893	0	717	3096	0	0	1179	0	813	1638	0
Right Turn on Red			No			No			No			No
Satd. Flow (RTOR)												
Link Speed (mph)		20			30			25			25	
Link Distance (ft)		1200			1013			995			363	
Travel Time (s)		40.9			23.0			27.1			9.9	
Confl. Peds. (#/hr)	50		25	25		50	93		33	33		93
Peak Hour Factor	0.91	0.91	0.91	0.91	0.91	0.91	0.94	0.94	0.94	0.90	0.90	0.90
Heavy Vehicles (%)	5%	5%	5%	3%	3%	3%	2%	2%	2%	4%	4%	4%
Adj. Flow (vph)	60	364	163	45	407	158	88	170	24	77	216	26
Shared Lane Traffic (%)												
Lane Group Flow (vph)	60	527	0	45	565	0	0	282	0	77	242	0
Turn Type	Perm	NA		Perm	NA		pm+pt	NA		D.Pm	NA	
Protected Phases		2			6		7	4				8
Permitted Phases	2			6			4			4		
Detector Phase	2	2		6	6		7	4		4		8
Switch Phase												
Minimum Initial (s)	10.0	10.0		10.0	10.0		7.0	7.0		7.0	7.0	
Minimum Split (s)	16.0	16.0		16.0	16.0		14.0	30.0		30.0	29.0	
Total Split (s)	60.0	60.0		60.0	60.0		31.0	70.0		70.0	39.0	
Total Split (%)	46.2%	46.2%		46.2%	46.2%		23.8%	53.8%		53.8%	30.0%	
Maximum Green (s)	54.7	54.7		54.7	54.7		24.8	63.6		63.6	32.6	
Yellow Time (s)	3.0	3.0		3.0	3.0		3.0	3.1		3.1	3.1	
All-Red Time (s)	2.3	2.3		2.3	2.3		3.2	3.3		3.3	3.3	
Lost Time Adjust (s)	-0.3	-0.3		-0.3	-0.3			-1.4		-1.4	-1.4	
Total Lost Time (s)	5.0	5.0		5.0	5.0			5.0		5.0	5.0	
Lead/Lag							Lead				Lag	
Lead-Lag Optimize?												
Vehicle Extension (s)	3.0	3.0		3.0	3.0		3.0	2.0		2.0	2.0	
Recall Mode	C-Max	C-Max		C-Max	C-Max		None	None		None	None	
Walk Time (s)								7.0		7.0	7.0	
Flash Dont Walk (s)								16.0		16.0	15.0	
Pedestrian Calls (#/hr)								0		0	0	
Act Effect Green (s)	80.0	80.0		80.0	80.0			40.0		40.0	40.0	

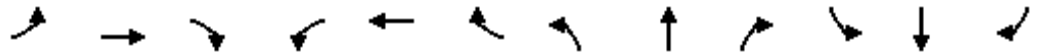

Lane Group	EBL	EBT	EBR	WBL	WBT	WBR	NBL	NBT	NBR	SBL	SBT	SBR
Actuated g/C Ratio	0.62	0.62		0.62	0.62			0.31		0.31	0.31	
v/c Ratio	0.15	0.30		0.10	0.30			0.78		0.31	0.48	
Control Delay	13.4	11.2		14.3	13.8			54.7		33.7	38.0	
Queue Delay	0.0	0.0		0.0	0.0			0.0		0.0	4.4	
Total Delay	13.4	11.2		14.3	13.8			54.7		33.7	42.4	
LOS	B	B		B	B			D		C	D	
Approach Delay		11.5			13.8			54.7			40.3	
Approach LOS		B			B			D			D	
Queue Length 50th (ft)	12	62		15	111			216		47	160	
Queue Length 95th (ft)	52	157		43	189			278		78	205	
Internal Link Dist (ft)		1120			933			915			283	
Turn Bay Length (ft)	75			75						100		
Base Capacity (vph)	402	1780		441	1905			589		406	524	
Starvation Cap Reductn	0	0		0	0			0		0	207	
Spillback Cap Reductn	0	0		0	0			0		0	0	
Storage Cap Reductn	0	0		0	0			0		0	0	
Reduced v/c Ratio	0.15	0.30		0.10	0.30			0.48		0.19	0.76	

Intersection Summary

Area Type:	Other
Cycle Length:	130
Actuated Cycle Length:	130
Offset:	57 (44%), Referenced to phase 2:EBTL and 6:WBTL, Start of Green
Natural Cycle:	60
Control Type:	Actuated-Coordinated
Maximum v/c Ratio:	0.78
Intersection Signal Delay:	24.2
Intersection LOS:	C
Intersection Capacity Utilization	76.7%
ICU Level of Service	D
Analysis Period (min)	15

Splits and Phases: 11: Raleigh Street/Hillsborough Street & E. Franklin Street

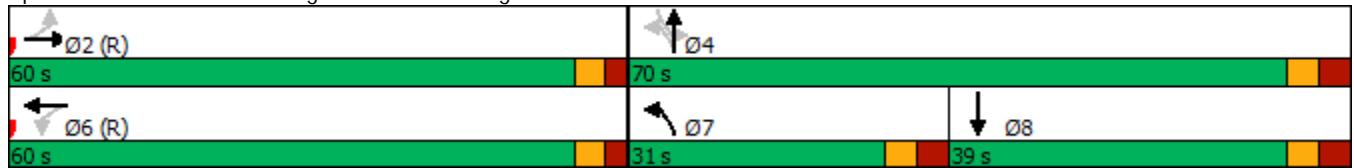

Lanes, Volumes, Timings

2022 Build Alternative 1 Noon Peak

14: NC 86 (MLK Jr. Blvd) & Longview Street/Mill Creek Apts Driveway

Timing Plan: Noon Peak

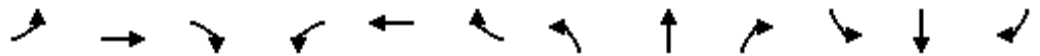

Lane Group	EBL	EBT	EBR	WBL	WBT	WBR	NBL	NBT	NBR	SBL	SBT	SBR
Lane Configurations		↕			↕		↕	↕↔		↕	↕↔	
Traffic Volume (vph)	37	0	19	4	0	2	7	509	8	1	559	35
Future Volume (vph)	37	0	19	4	0	2	7	509	8	1	559	35
Ideal Flow (vphpl)	1900	1900	1900	1900	1900	1900	1900	1900	1900	1900	1900	1900
Grade (%)		-6%			1%			2%			-4%	
Storage Length (ft)	0		0	0		0	225		0	250		0
Storage Lanes	0		0	0		0	1		0	1		0
Taper Length (ft)	25			25			25			25		
Lane Util. Factor	1.00	1.00	1.00	1.00	1.00	1.00	1.00	0.95	0.95	1.00	0.95	0.95
Ped Bike Factor		0.99			0.98		0.99	1.00		0.98	1.00	
Frt		0.954			0.955			0.998			0.991	
Flt Protected		0.968			0.968		0.950			0.950		
Satd. Flow (prot)	0	1720	0	0	1706	0	1670	3330	0	1753	3468	0
Flt Permitted		0.794			0.754		0.404			0.433		
Satd. Flow (perm)	0	1410	0	0	1314	0	705	3330	0	786	3468	0
Right Turn on Red			No			No			No			No
Satd. Flow (RTOR)												
Link Speed (mph)		25			20			35			35	
Link Distance (ft)		451			338			2108			784	
Travel Time (s)		12.3			11.5			41.1			15.3	
Confl. Peds. (#/hr)	1		19	19		1	7		15	15		7
Peak Hour Factor	0.76	0.76	0.76	0.50	0.50	0.50	0.89	0.89	0.89	0.91	0.91	0.91
Heavy Vehicles (%)	4%	4%	4%	2%	2%	2%	7%	7%	7%	5%	5%	5%
Adj. Flow (vph)	49	0	25	8	0	4	8	572	9	1	614	38
Shared Lane Traffic (%)												
Lane Group Flow (vph)	0	74	0	0	12	0	8	581	0	1	652	0
Turn Type	Perm	NA		Perm	NA		Perm	NA		Perm	NA	
Protected Phases		4			8			2			6	
Permitted Phases	4			8			2			6		
Detector Phase	4	4		8	8		2	2		6	6	
Switch Phase												
Minimum Initial (s)	7.0	7.0		7.0	7.0		12.0	12.0		12.0	12.0	
Minimum Split (s)	31.0	31.0		14.0	14.0		28.0	28.0		28.0	28.0	
Total Split (s)	20.0	20.0		20.0	20.0		60.0	60.0		60.0	60.0	
Total Split (%)	25.0%	25.0%		25.0%	25.0%		75.0%	75.0%		75.0%	75.0%	
Maximum Green (s)	14.0	14.0		13.9	13.9		54.0	54.0		54.5	54.5	
Yellow Time (s)	3.5	3.5		3.0	3.0		4.5	4.5		4.0	4.0	
All-Red Time (s)	2.5	2.5		3.1	3.1		1.5	1.5		1.5	1.5	
Lost Time Adjust (s)		-1.0			-1.0		-1.0	-1.0		-0.5	-0.5	
Total Lost Time (s)		5.0			5.1		5.0	5.0		5.0	5.0	
Lead/Lag												
Lead-Lag Optimize?												
Vehicle Extension (s)	3.0	3.0		3.0	3.0		3.0	3.0		3.0	3.0	
Recall Mode	None	None		None	None		Min	Min		Min	Min	
Walk Time (s)	7.0	7.0					7.0	7.0		7.0	7.0	
Flash Dont Walk (s)	17.0	17.0					9.0	9.0		9.0	9.0	
Pedestrian Calls (#/hr)	0	0					0	0		0	0	
Act Effct Green (s)		8.7			8.6		24.4	24.4		24.4	24.4	
Actuated g/C Ratio		0.25			0.24		0.69	0.69		0.69	0.69	

Lanes, Volumes, Timings

2022 Build Alternative 1 Noon Peak

14: NC 86 (MLK Jr. Blvd) & Longview Street/Mill Creek Apts Driveway

Timing Plan: Noon Peak

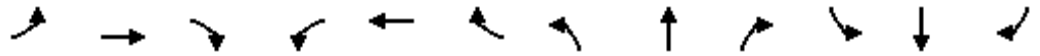

Lane Group	EBL	EBT	EBR	WBL	WBT	WBR	NBL	NBT	NBR	SBL	SBT	SBR
v/c Ratio		0.21			0.04		0.02	0.25		0.00	0.27	
Control Delay		12.7			10.8		5.4	5.1		5.0	5.1	
Queue Delay		0.0			0.0		0.0	0.0		0.0	0.0	
Total Delay		12.7			10.8		5.4	5.1		5.0	5.1	
LOS		B			B		A	A		A	A	
Approach Delay		12.7			10.8			5.1			5.1	
Approach LOS		B			B			A			A	
Queue Length 50th (ft)		14			2		1	32		0	36	
Queue Length 95th (ft)		27			5		5	59		2	67	
Internal Link Dist (ft)		371			258			2028			704	
Turn Bay Length (ft)							225			250		
Base Capacity (vph)		600			555		705	3330		786	3468	
Starvation Cap Reductn		0			0		0	0		0	0	
Spillback Cap Reductn		0			0		0	0		0	0	
Storage Cap Reductn		0			0		0	0		0	0	
Reduced v/c Ratio		0.12			0.02		0.01	0.17		0.00	0.19	

Intersection Summary

Area Type:	Other
Cycle Length:	80
Actuated Cycle Length:	35.4
Natural Cycle:	60
Control Type:	Actuated-Uncoordinated
Maximum v/c Ratio:	0.27
Intersection Signal Delay:	5.6
Intersection LOS:	A
Intersection Capacity Utilization:	37.4%
ICU Level of Service:	A
Analysis Period (min):	15

Splits and Phases: 14: NC 86 (MLK Jr. Blvd) & Longview Street/Mill Creek Apts Driveway



Lanes, Volumes, Timings
15: NC 86 (Pittsboro St) & W. Cameron Avenue

2022 Build Alternative 1 Noon Peak
Timing Plan: Noon Peak



Lane Group	EBT	EBR	WBL	WBT	NBL	NBR	Ø1	Ø4
Lane Configurations	↻		↻↻	↻				
Traffic Volume (vph)	78	152	450	215	0	0		
Future Volume (vph)	78	152	450	215	0	0		
Ideal Flow (vphpl)	1900	1900	1900	1900	1900	1900		
Lane Width (ft)	12	12	11	12	12	12		
Grade (%)	3%			-3%	0%			
Storage Length (ft)		0	75		0	0		
Storage Lanes		0	0		0	0		
Taper Length (ft)			25		25			
Lane Util. Factor	1.00	1.00	0.97	1.00	1.00	1.00		
Ped Bike Factor	0.78		0.65					
Frt	0.911							
Flt Protected			0.950					
Satd. Flow (prot)	1170	0	2837	1592	0	0		
Flt Permitted			0.950					
Satd. Flow (perm)	1170	0	1838	1592	0	0		
Right Turn on Red		No				No		
Satd. Flow (RTOR)								
Link Speed (mph)	25			25	25			
Link Distance (ft)	391			120	794			
Travel Time (s)	30.0			10.7	21.7			
Confl. Peds. (#/hr)		129	129					
Peak Hour Factor	0.71	0.71	0.93	0.93	0.90	0.90		
Heavy Vehicles (%)	2%	2%	9%	9%	2%	2%		
Adj. Flow (vph)	110	214	484	231	0	0		
Shared Lane Traffic (%)								
Lane Group Flow (vph)	324	0	484	231	0	0		
Turn Type	NA		Prot	NA				
Protected Phases	2		1 4	6			1	4
Permitted Phases								
Detector Phase	2		1 4	6				
Switch Phase								
Minimum Initial (s)	10.0			10.0			7.0	7.0
Minimum Split (s)	20.0			20.0			20.0	20.0
Total Split (s)	77.0			110.0			33.0	20.0
Total Split (%)	59.2%			84.6%			25%	15%
Maximum Green (s)	71.9			105.0			27.9	16.0
Yellow Time (s)	3.0			3.3			3.0	3.0
All-Red Time (s)	2.1			1.7			2.1	1.0
Lost Time Adjust (s)	-0.1			0.0				
Total Lost Time (s)	5.0			5.0				
Lead/Lag	Lag						Lead	
Lead-Lag Optimize?								
Vehicle Extension (s)	1.0			1.0			4.0	0.2
Recall Mode	None			C-Max			C-Max	None
Walk Time (s)	7.0							7.0
Flash Dont Walk (s)	4.0							9.0
Pedestrian Calls (#/hr)	0							0
Act Effect Green (s)	72.0		48.0	105.5				

Lanes, Volumes, Timings
 15: NC 86 (Pittsboro St) & W. Cameron Avenue

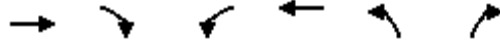

Lane Group	EBT	EBR	WBL	WBT	NBL	NBR	Ø1	Ø4
Actuated g/C Ratio	0.55		0.37	0.81				
v/c Ratio	0.50		0.46	0.18				
Control Delay	21.3		26.2	3.2				
Queue Delay	0.0		1.2	0.5				
Total Delay	21.3		27.3	3.8				
LOS	C		C	A				
Approach Delay	21.3			19.7				
Approach LOS	C			B				
Queue Length 50th (ft)	162		161	29				
Queue Length 95th (ft)	174		243	m65				
Internal Link Dist (ft)	311			40	714			
Turn Bay Length (ft)			75					
Base Capacity (vph)	648		1035	1291				
Starvation Cap Reductn	0		325	720				
Spillback Cap Reductn	0		0	0				
Storage Cap Reductn	0		0	0				
Reduced v/c Ratio	0.50		0.68	0.40				

Intersection Summary

Area Type: CBD
 Cycle Length: 130
 Actuated Cycle Length: 130
 Offset: 28 (22%), Referenced to phase 1:WBL and 6:WBT, Start of Green
 Natural Cycle: 60
 Control Type: Actuated-Coordinated
 Maximum v/c Ratio: 0.50
 Intersection Signal Delay: 20.2
 Intersection LOS: C
 Intersection Capacity Utilization 42.0%
 ICU Level of Service A
 Analysis Period (min) 15
 m Volume for 95th percentile queue is metered by upstream signal.

Splits and Phases: 15: NC 86 (Pittsboro St) & W. Cameron Avenue



Lanes, Volumes, Timings

2022 Build Alternative 1 Noon Peak

16: NC 86 (S. Columbia St) & W. Cameron Avenue/E. Cameron Avenue

Timing Plan: Noon Peak

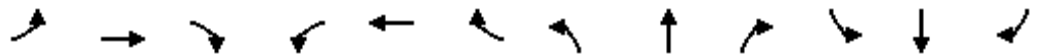

Lane Group	EBL	EBT	EBR	WBL	WBT	WBR	NBL	NBT	NBR	SBL	SBT	SBR
Lane Configurations												
Traffic Volume (vph)	20	51	0	0	90	37	169	384	27	43	0	405
Future Volume (vph)	20	51	0	0	90	37	169	384	27	43	0	405
Ideal Flow (vphpl)	1900	1900	1900	1900	1900	1900	1900	1900	1900	1900	1900	1900
Lane Width (ft)	11	12	12	12	12	12	10	10	10	11	11	12
Grade (%)		1%			-1%			1%			2%	
Storage Length (ft)	100		0	0		0	0		0	310		0
Storage Lanes	1		0	0		0	1		0	1		2
Taper Length (ft)	25			25			25			25		
Lane Util. Factor	1.00	1.00	1.00	1.00	1.00	1.00	0.91	0.91	0.95	1.00	1.00	0.88
Ped Bike Factor	0.77				0.91		0.60	0.94		0.61		0.43
Frt					0.961			0.991				0.850
Flt Protected	0.950						0.950	0.998		0.950		
Satd. Flow (prot)	1488	1620	0	0	1403	0	1259	2495	0	1439	0	2345
Flt Permitted	0.489						0.950	0.998		0.950		
Satd. Flow (perm)	590	1620	0	0	1403	0	757	2455	0	879	0	1014
Right Turn on Red			No			No			No			No
Satd. Flow (RTOR)												
Link Speed (mph)		25			25			25				25
Link Distance (ft)		273			989			826				981
Travel Time (s)		10.7			57.6			22.5				26.8
Confl. Peds. (#/hr)	207		358	358		207	244		349	349		244
Peak Hour Factor	0.93	0.93	0.93	0.84	0.84	0.84	0.86	0.86	0.86	0.86	0.86	0.86
Heavy Vehicles (%)	5%	5%	5%	7%	7%	7%	9%	9%	9%	8%	8%	8%
Adj. Flow (vph)	22	55	0	0	107	44	197	447	31	50	0	471
Shared Lane Traffic (%)							10%					
Lane Group Flow (vph)	22	55	0	0	151	0	177	498	0	50	0	471
Turn Type	Perm	NA			NA		Split	NA		Prot		Prot
Protected Phases		4			8		2	2		1		1
Permitted Phases	4									1		1
Detector Phase	4	4			8		2	2		1		1
Switch Phase												
Minimum Initial (s)	10.0	10.0			10.0		7.0	7.0		7.0		7.0
Minimum Split (s)	24.0	24.0			31.0		18.0	18.0		26.0		26.0
Total Split (s)	40.0	40.0			40.0		23.0	23.0		39.0		39.0
Total Split (%)	30.8%	30.8%			30.8%		17.7%	17.7%		30.0%		30.0%
Maximum Green (s)	33.8	33.8			33.8		17.1	17.1		33.4		33.4
Yellow Time (s)	3.2	3.2			3.2		3.1	3.1		3.0		3.0
All-Red Time (s)	3.0	3.0			3.0		2.8	2.8		2.6		2.6
Lost Time Adjust (s)	-1.2	-1.2			-1.2		-0.9	-0.9		-0.6		-0.6
Total Lost Time (s)	5.0	5.0			5.0		5.0	5.0		5.0		5.0
Lead/Lag							Lead	Lead		Lag		Lag
Lead-Lag Optimize?												
Vehicle Extension (s)	2.0	2.0			2.0		4.0	4.0		4.0		4.0
Recall Mode	None	None			None		C-Max	C-Max		None		None
Walk Time (s)	7.0	7.0			7.0		7.0	7.0		7.0		7.0
Flash Dont Walk (s)	10.0	10.0			17.0		5.0	5.0		13.0		13.0
Pedestrian Calls (#/hr)	0	0			0		0	0		0		0
Act Effect Green (s)	19.6	19.6			19.6		64.3	64.3		31.1		31.1

Lane Group	Ø9
Lane Configurations	
Traffic Volume (vph)	
Future Volume (vph)	
Ideal Flow (vphpl)	
Lane Width (ft)	
Grade (%)	
Storage Length (ft)	
Storage Lanes	
Taper Length (ft)	
Lane Util. Factor	
Ped Bike Factor	
Frt	
Flt Protected	
Satd. Flow (prot)	
Flt Permitted	
Satd. Flow (perm)	
Right Turn on Red	
Satd. Flow (RTOR)	
Link Speed (mph)	
Link Distance (ft)	
Travel Time (s)	
Confl. Peds. (#/hr)	
Peak Hour Factor	
Heavy Vehicles (%)	
Adj. Flow (vph)	
Shared Lane Traffic (%)	
Lane Group Flow (vph)	
Turn Type	
Protected Phases	9
Permitted Phases	
Detector Phase	
Switch Phase	
Minimum Initial (s)	7.0
Minimum Split (s)	28.0
Total Split (s)	28.0
Total Split (%)	22%
Maximum Green (s)	24.0
Yellow Time (s)	3.0
All-Red Time (s)	1.0
Lost Time Adjust (s)	
Total Lost Time (s)	
Lead/Lag	
Lead-Lag Optimize?	
Vehicle Extension (s)	0.2
Recall Mode	None
Walk Time (s)	7.0
Flash Dont Walk (s)	17.0
Pedestrian Calls (#/hr)	0
Act Effect Green (s)	

Lanes, Volumes, Timings

2022 Build Alternative 1 Noon Peak

16: NC 86 (S. Columbia St) & W. Cameron Avenue/E. Cameron Avenue

Timing Plan: Noon Peak



Lane Group	EBL	EBT	EBR	WBL	WBT	WBR	NBL	NBT	NBR	SBL	SBT	SBR
Actuated g/C Ratio	0.15	0.15			0.15		0.49	0.49		0.24		0.24
v/c Ratio	0.25	0.23			0.71		0.28	0.40		0.15		0.84
Control Delay	38.0	33.6			70.0		23.3	23.7		19.1		36.8
Queue Delay	0.0	0.0			0.0		0.0	0.0		0.0		0.0
Total Delay	38.0	33.6			70.0		23.3	23.7		19.1		36.8
LOS	D	C			E		C	C		B		D
Approach Delay		34.9			70.0			23.6				35.1
Approach LOS		C			E			C				D
Queue Length 50th (ft)	17	42			123		97	147		19		198
Queue Length 95th (ft)	m35	84			171		168	209		m35		286
Internal Link Dist (ft)		193			909			746				901
Turn Bay Length (ft)	100									310		
Base Capacity (vph)	158	436			377		622	1233		376		613
Starvation Cap Reductn	0	0			0		0	0		0		0
Spillback Cap Reductn	0	0			0		0	0		0		0
Storage Cap Reductn	0	0			0		0	0		0		0
Reduced v/c Ratio	0.14	0.13			0.40		0.28	0.40		0.13		0.77

Intersection Summary

Area Type: CBD
 Cycle Length: 130
 Actuated Cycle Length: 130
 Offset: 67 (52%), Referenced to phase 2:NBTL, Start of Green
 Natural Cycle: 105
 Control Type: Actuated-Coordinated
 Maximum v/c Ratio: 0.84
 Intersection Signal Delay: 33.4
 Intersection LOS: C
 Intersection Capacity Utilization 69.0%
 ICU Level of Service C
 Analysis Period (min) 15
 m Volume for 95th percentile queue is metered by upstream signal.

Splits and Phases: 16: NC 86 (S. Columbia St) & W. Cameron Avenue/E. Cameron Avenue

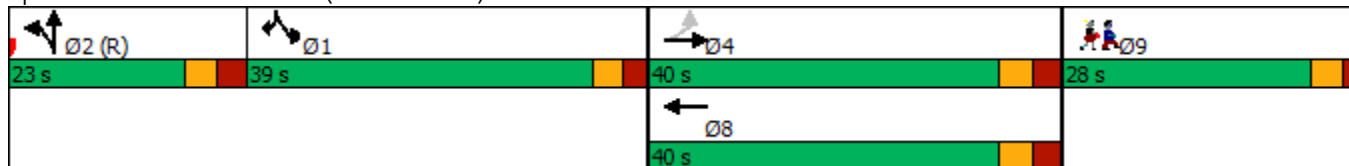

Lane Group	Ø9
Actuated g/C Ratio	
v/c Ratio	
Control Delay	
Queue Delay	
Total Delay	
LOS	
Approach Delay	
Approach LOS	
Queue Length 50th (ft)	
Queue Length 95th (ft)	
Internal Link Dist (ft)	
Turn Bay Length (ft)	
Base Capacity (vph)	
Starvation Cap Reductn	
Spillback Cap Reductn	
Storage Cap Reductn	
Reduced v/c Ratio	
Intersection Summary	

Lanes, Volumes, Timings

2022 Build Alternative 1 Noon Peak

17: Raleigh Street & E. Cameron Avenue/Country Club Road

Timing Plan: Noon Peak

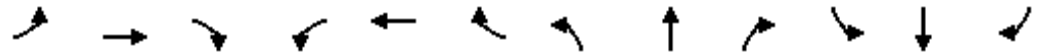

Lane Group	EBL	EBT	EBR	WBL	WBT	WBR	NBL	NBT	NBR	SBL	SBT	SBR
Lane Configurations		↕		↖	↗		↖	↗		↖	↗	
Traffic Volume (vph)	31	64	33	21	86	165	33	76	28	233	111	44
Future Volume (vph)	31	64	33	21	86	165	33	76	28	233	111	44
Ideal Flow (vphpl)	1900	1900	1900	1900	1900	1900	1900	1900	1900	1900	1900	1900
Grade (%)		-3%			3%			-2%			1%	
Storage Length (ft)	0		0	150		0	125		0	75		0
Storage Lanes	0		0	1		0	1		0	1		0
Taper Length (ft)	25			25			25			25		
Lane Util. Factor	1.00	1.00	1.00	1.00	1.00	1.00	1.00	1.00	1.00	1.00	1.00	1.00
Ped Bike Factor		0.91		0.90	0.87		0.67	0.95		0.87	0.85	
Frt		0.965			0.902			0.960			0.958	
Flt Protected		0.988		0.950			0.950			0.950		
Satd. Flow (prot)	0	1514	0	1569	1295	0	1505	1450	0	1554	1329	0
Flt Permitted		0.845		0.537			0.654			0.453		
Satd. Flow (perm)	0	1256	0	796	1295	0	697	1450	0	646	1329	0
Right Turn on Red			No			No			No			No
Satd. Flow (RTOR)												
Link Speed (mph)		25			25			25			25	
Link Distance (ft)		598			651			409			995	
Travel Time (s)		16.3			17.8			11.2			27.1	
Confl. Peds. (#/hr)	38		43	43		38	103		33	33		103
Peak Hour Factor	0.87	0.87	0.87	0.91	0.91	0.91	0.93	0.93	0.93	0.95	0.95	0.95
Heavy Vehicles (%)	2%	2%	2%	2%	2%	2%	9%	9%	9%	4%	4%	4%
Adj. Flow (vph)	36	74	38	23	95	181	35	82	30	245	117	46
Shared Lane Traffic (%)												
Lane Group Flow (vph)	0	148	0	23	276	0	35	112	0	245	163	0
Turn Type	Perm	NA		pm+pt	NA		pm+pt	NA		pm+pt	NA	
Protected Phases		2		1	6		3	8		7	4	
Permitted Phases	2			6			8			4		
Detector Phase	2	2		1	6		3	8		7	4	
Switch Phase												
Minimum Initial (s)	10.0	10.0		7.0	10.0		7.0	7.0		7.0	7.0	
Minimum Split (s)	18.0	18.0		13.0	19.0		13.0	19.0		12.0	16.0	
Total Split (s)	50.0	50.0		20.0	70.0		20.0	35.0		20.0	35.0	
Total Split (%)	40.0%	40.0%		16.0%	56.0%		16.0%	28.0%		16.0%	28.0%	
Maximum Green (s)	43.9	43.9		14.4	64.4		14.7	29.7		15.1	29.9	
Yellow Time (s)	3.3	3.3		3.0	3.1		3.0	3.1		3.0	3.1	
All-Red Time (s)	2.8	2.8		2.6	2.5		2.3	2.2		1.9	2.0	
Lost Time Adjust (s)		-1.1		-0.6	-0.6		-0.3	-0.3		0.1	-0.1	
Total Lost Time (s)		5.0		5.0	5.0		5.0	5.0		5.0	5.0	
Lead/Lag	Lag	Lag		Lead			Lead	Lag		Lead	Lag	
Lead-Lag Optimize?	Yes	Yes		Yes			Yes	Yes		Yes	Yes	
Vehicle Extension (s)	2.0	2.0		2.0	2.0		2.0	2.0		2.0	2.0	
Recall Mode	None	None		None	None		None	None		None	None	
Walk Time (s)	4.0	4.0			4.0			4.0			4.0	
Flash Dont Walk (s)	7.0	7.0			9.0			9.0			6.0	
Pedestrian Calls (#/hr)	0	0			0			0			0	
Act Effect Green (s)		16.1		19.7	19.7		15.9	10.5		24.7	20.9	
Actuated g/C Ratio		0.29		0.35	0.35		0.29	0.19		0.44	0.38	

Lanes, Volumes, Timings
 17: Raleigh Street & E. Cameron Avenue/Country Club Road

2022 Build Alternative 1 Noon Peak
 Timing Plan: Noon Peak



Lane Group	EBL	EBT	EBR	WBL	WBT	WBR	NBL	NBT	NBR	SBL	SBT	SBR
v/c Ratio		0.41		0.06	0.60		0.11	0.41		0.49	0.33	
Control Delay		25.4		13.7	22.5		12.5	30.0		14.8	19.0	
Queue Delay		0.0		0.0	0.0		0.0	0.0		0.0	0.0	
Total Delay		25.4		13.7	22.5		12.5	30.0		14.8	19.0	
LOS		C		B	C		B	C		B	B	
Approach Delay		25.4			21.8			25.8			16.5	
Approach LOS		C			C			C			B	
Queue Length 50th (ft)		39		5	82		5	34		42	27	
Queue Length 95th (ft)		110		19	166		25	95		127	118	
Internal Link Dist (ft)		518			571			329			915	
Turn Bay Length (ft)				150			125			75		
Base Capacity (vph)		1003		548	1236		553	868		593	796	
Starvation Cap Reductn		0		0	0		0	0		0	0	
Spillback Cap Reductn		0		0	0		0	0		0	0	
Storage Cap Reductn		0		0	0		0	0		0	0	
Reduced v/c Ratio		0.15		0.04	0.22		0.06	0.13		0.41	0.20	

Intersection Summary

Area Type: CBD
 Cycle Length: 125
 Actuated Cycle Length: 55.7
 Natural Cycle: 65
 Control Type: Actuated-Uncoordinated
 Maximum v/c Ratio: 0.60
 Intersection Signal Delay: 20.8
 Intersection LOS: C
 Intersection Capacity Utilization 68.1%
 ICU Level of Service C
 Analysis Period (min) 15

Splits and Phases: 17: Raleigh Street & E. Cameron Avenue/Country Club Road



Lanes, Volumes, Timings
1: Church Street & W. Rosemary Street

2022 Build Alternative 1 PM Peak

Timing Plan: PM Peak



Lane Group	EBL	EBT	EBR	WBL	WBT	WBR	NBL	NBT	NBR	SBL	SBT	SBR
Lane Configurations		↕			↕			↕			↕	
Traffic Volume (vph)	24	422	65	59	437	37	47	79	63	24	75	26
Future Volume (vph)	24	422	65	59	437	37	47	79	63	24	75	26
Ideal Flow (vphpl)	1900	1900	1900	1900	1900	1900	1900	1900	1900	1900	1900	1900
Lane Width (ft)	12	14	12	12	14	12	12	12	12	12	12	12
Grade (%)		1%			-1%			0%			0%	
Lane Util. Factor	1.00	1.00	1.00	1.00	1.00	1.00	1.00	1.00	1.00	1.00	1.00	1.00
Ped Bike Factor		0.98			0.98			0.93			0.95	
Frt		0.983			0.991			0.955			0.972	
Flt Protected		0.998			0.994			0.988			0.990	
Satd. Flow (prot)	0	1710	0	0	1751	0	0	1516	0	0	1556	0
Flt Permitted		0.967			0.903			0.903			0.925	
Satd. Flow (perm)	0	1654	0	0	1583	0	0	1345	0	0	1435	0
Right Turn on Red			No			No			No			No
Satd. Flow (RTOR)												
Link Speed (mph)		20			20			25			25	
Link Distance (ft)		964			757			379			430	
Travel Time (s)		32.9			25.8			10.3			11.7	
Confl. Peds. (#/hr)	40		37	37		40	62		43	43		62
Peak Hour Factor	0.95	0.95	0.95	0.97	0.97	0.97	0.91	0.91	0.91	0.93	0.93	0.93
Adj. Flow (vph)	25	444	68	61	451	38	52	87	69	26	81	28
Shared Lane Traffic (%)												
Lane Group Flow (vph)	0	537	0	0	550	0	0	208	0	0	135	0
Turn Type	Perm	NA		Perm	NA		Perm	NA		Perm	NA	
Protected Phases		2			6			8			4	
Permitted Phases	2			6			8			4		
Detector Phase	2	2		6	6		8	8		4	4	
Switch Phase												
Minimum Initial (s)	10.0	10.0		10.0	10.0		7.0	7.0		7.0	7.0	
Minimum Split (s)	19.0	19.0		20.0	20.0		19.0	19.0		19.0	19.0	
Total Split (s)	45.0	45.0		45.0	45.0		25.0	25.0		25.0	25.0	
Total Split (%)	64.3%	64.3%		64.3%	64.3%		35.7%	35.7%		35.7%	35.7%	
Maximum Green (s)	40.5	40.5		40.4	40.4		20.1	20.1		20.1	20.1	
Yellow Time (s)	3.1	3.1		3.1	3.1		3.2	3.2		3.2	3.2	
All-Red Time (s)	1.4	1.4		1.5	1.5		1.7	1.7		1.7	1.7	
Lost Time Adjust (s)		0.5			0.4			0.1			0.1	
Total Lost Time (s)		5.0			5.0			5.0			5.0	
Lead/Lag												
Lead-Lag Optimize?												
Vehicle Extension (s)	3.0	3.0		3.0	3.0		3.0	3.0		3.0	3.0	
Recall Mode	C-Max	C-Max		C-Max	C-Max		None	None		None	None	
Walk Time (s)	4.0	4.0		4.0	4.0		4.0	4.0		4.0	4.0	
Flash Dont Walk (s)	5.0	5.0		6.0	6.0		10.0	10.0		10.0	10.0	
Pedestrian Calls (#/hr)	0	0		0	0		0	0		0	0	
Act Effct Green (s)		44.6			44.6			15.4			15.4	
Actuated g/C Ratio		0.64			0.64			0.22			0.22	
v/c Ratio		0.51			0.55			0.71			0.43	
Control Delay		9.9			5.8			36.9			26.6	
Queue Delay		0.0			0.0			0.0			0.0	

Lanes, Volumes, Timings
 1: Church Street & W. Rosemary Street

2022 Build Alternative 1 PM Peak
 Timing Plan: PM Peak



Lane Group	EBL	EBT	EBR	WBL	WBT	WBR	NBL	NBT	NBR	SBL	SBT	SBR
Total Delay		9.9			5.8			36.9			26.6	
LOS		A			A			D			C	
Approach Delay		9.9			5.8			36.9			26.6	
Approach LOS		A			A			D			C	
Queue Length 50th (ft)		111			76			77			50	
Queue Length 95th (ft)		217			m78			m92			90	
Internal Link Dist (ft)		884			677			299			350	
Turn Bay Length (ft)												
Base Capacity (vph)		1053			1008			384			410	
Starvation Cap Reductn		0			0			0			0	
Spillback Cap Reductn		0			0			0			0	
Storage Cap Reductn		0			0			0			0	
Reduced v/c Ratio		0.51			0.55			0.54			0.33	

Intersection Summary

Area Type: CBD
 Cycle Length: 70
 Actuated Cycle Length: 70
 Offset: 25 (36%), Referenced to phase 2:EBTL and 6:WBTL, Start of Green
 Natural Cycle: 50
 Control Type: Actuated-Coordinated
 Maximum v/c Ratio: 0.71
 Intersection Signal Delay: 13.8
 Intersection LOS: B
 Intersection Capacity Utilization 79.7%
 ICU Level of Service D
 Analysis Period (min) 15
 m Volume for 95th percentile queue is metered by upstream signal.

Splits and Phases: 1: Church Street & W. Rosemary Street



Lanes, Volumes, Timings

2022 Build Alternative 1 PM Peak

2: NC 86 (N. Columbia St) & W. Rosemary Street/E. Rosemary Street

Timing Plan: PM Peak



Lane Group	EBL	EBT	EBR	WBL	WBT	WBR	NBL	NBT	NBR	SBL	SBT	SBR
Lane Configurations												
Traffic Volume (vph)	230	269	49	90	225	110	51	591	89	88	510	274
Future Volume (vph)	230	269	49	90	225	110	51	591	89	88	510	274
Ideal Flow (vphpl)	1900	1900	1900	1900	1900	1900	1900	1900	1900	1900	1900	1900
Lane Width (ft)	9	12	13	12	12	12	9	10	12	12	9	11
Grade (%)		1%			1%			-2%			8%	
Storage Length (ft)	100		0	75		0	75		0	150		400
Storage Lanes	1		0	1		0	1		0	1		1
Taper Length (ft)	25			25			25			25		
Lane Util. Factor	1.00	1.00	1.00	1.00	1.00	1.00	1.00	0.95	0.95	1.00	0.95	1.00
Ped Bike Factor		0.99		0.96	0.97		0.94	0.95				0.73
Frt		0.977			0.951			0.980				0.850
Flt Protected	0.950			0.950			0.950			0.950		
Satd. Flow (prot)	1426	1612	0	1585	1540	0	1420	2752	0	1514	2725	1310
Flt Permitted	0.126			0.545			0.357			0.238		
Satd. Flow (perm)	189	1612	0	876	1540	0	499	2752	0	379	2725	952
Right Turn on Red			No			No			No			No
Satd. Flow (RTOR)												
Link Speed (mph)		20			20			25			25	
Link Distance (ft)		757			251			353			476	
Travel Time (s)		25.8			8.6			9.6			13.0	
Confl. Peds. (#/hr)	49		36	36		49	59		83	83		59
Peak Hour Factor	0.88	0.88	0.88	0.94	0.94	0.94	0.83	0.83	0.83	0.82	0.82	0.82
Heavy Vehicles (%)	2%	2%	2%	2%	2%	2%	4%	4%	4%	3%	3%	3%
Adj. Flow (vph)	261	306	56	96	239	117	61	712	107	107	622	334
Shared Lane Traffic (%)												
Lane Group Flow (vph)	261	362	0	96	356	0	61	819	0	107	622	334
Turn Type	pm+pt	NA		Perm	NA		pm+pt	NA		pm+pt	NA	pm+ov
Protected Phases	7	4			8		5	2		1	6	7
Permitted Phases	4			8			2			6		6
Detector Phase	7	4		8	8		5	2		1	6	7
Switch Phase												
Minimum Initial (s)	7.0	7.0		7.0	7.0		7.0	10.0		7.0	10.0	7.0
Minimum Split (s)	13.0	31.0		32.0	32.0		13.0	23.0		13.0	22.0	13.0
Total Split (s)	24.0	56.0		32.0	32.0		20.0	64.0		20.0	64.0	24.0
Total Split (%)	17.1%	40.0%		22.9%	22.9%		14.3%	45.7%		14.3%	45.7%	17.1%
Maximum Green (s)	18.2	50.0		26.0	26.0		14.2	58.2		14.9	58.2	18.2
Yellow Time (s)	3.0	3.2		3.2	3.2		3.0	3.3		3.0	3.3	3.0
All-Red Time (s)	2.8	2.8		2.8	2.8		2.8	2.5		2.1	2.5	2.8
Lost Time Adjust (s)	-0.8	-1.0		-1.0	-1.0		-1.0	-0.8		-0.1	-0.8	-0.8
Total Lost Time (s)	5.0	5.0		5.0	5.0		4.8	5.0		5.0	5.0	5.0
Lead/Lag	Lead			Lag	Lag		Lead	Lag		Lead	Lag	Lead
Lead-Lag Optimize?												
Vehicle Extension (s)	1.0	1.0		1.0	1.0		1.0	3.0		1.0	3.0	1.0
Recall Mode	None	None		None	None		None	C-Max		None	C-Max	None
Walk Time (s)		7.0		7.0	7.0			7.0			7.0	
Flash Dont Walk (s)		18.0		19.0	19.0			10.0			9.0	
Pedestrian Calls (#/hr)		0		0	0			0			0	
Act Effect Green (s)	51.0	51.0		27.0	27.0		73.9	65.3		75.6	68.4	87.4

Lanes, Volumes, Timings

2022 Build Alternative 1 PM Peak

2: NC 86 (N. Columbia St) & W. Rosemary Street/E. Rosemary Street

Timing Plan: PM Peak

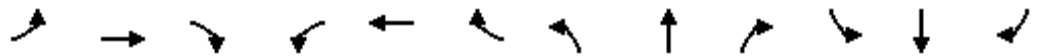

Lane Group	EBL	EBT	EBR	WBL	WBT	WBR	NBL	NBT	NBR	SBL	SBT	SBR
Actuated g/C Ratio	0.36	0.36		0.19	0.19		0.53	0.47		0.54	0.49	0.62
v/c Ratio	1.11	0.62		0.57	1.20		0.19	0.64		0.39	0.47	0.52
Control Delay	124.3	44.2		64.5	163.1		5.6	8.1		18.7	25.9	17.1
Queue Delay	0.0	0.0		0.0	0.0		0.0	3.3		0.0	0.0	0.0
Total Delay	124.3	44.2		64.5	163.1		5.6	11.4		18.7	26.0	17.1
LOS	F	D		E	F		A	B		B	C	B
Approach Delay		77.7			142.2			11.0			22.5	
Approach LOS		E			F			B			C	
Queue Length 50th (ft)	~230	291		79	-400		7	50		44	199	137
Queue Length 95th (ft)	#391	402		146	#592		m7	m52		67	230	181
Internal Link Dist (ft)		677			171			273			396	
Turn Bay Length (ft)	100			75			75			150		400
Base Capacity (vph)	236	587		168	297		381	1284		335	1330	642
Starvation Cap Reductn	0	0		0	0		0	356		0	0	0
Spillback Cap Reductn	0	0		0	0		0	0		0	52	0
Storage Cap Reductn	0	0		0	0		0	0		0	0	0
Reduced v/c Ratio	1.11	0.62		0.57	1.20		0.16	0.88		0.32	0.49	0.52

Intersection Summary

Area Type: CBD
 Cycle Length: 140
 Actuated Cycle Length: 140
 Offset: 62 (44%), Referenced to phase 2:NBTL and 6:SBTL, Start of Green
 Natural Cycle: 85
 Control Type: Actuated-Coordinated
 Maximum v/c Ratio: 1.20
 Intersection Signal Delay: 48.5
 Intersection LOS: D
 Intersection Capacity Utilization 80.6%
 ICU Level of Service D
 Analysis Period (min) 15
 ~ Volume exceeds capacity, queue is theoretically infinite.
 Queue shown is maximum after two cycles.
 # 95th percentile volume exceeds capacity, queue may be longer.
 Queue shown is maximum after two cycles.
 m Volume for 95th percentile queue is metered by upstream signal.

Splits and Phases: 2: NC 86 (N. Columbia St) & W. Rosemary Street/E. Rosemary Street

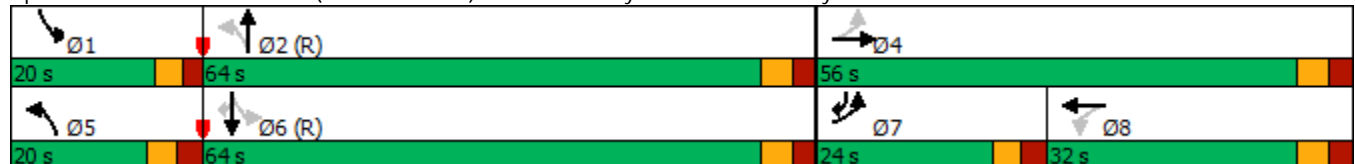

Lanes, Volumes, Timings
6: Henderson Street & E. Rosemary Street

2022 Build Alternative 1 PM Peak

Timing Plan: PM Peak



Lane Group	EBL	EBT	EBR	WBL	WBT	WBR	NBL	NBT	NBR	SBL	SBT	SBR
Lane Configurations												
Traffic Volume (vph)	43	270	153	12	194	57	63	24	5	23	41	10
Future Volume (vph)	43	270	153	12	194	57	63	24	5	23	41	10
Ideal Flow (vphpl)	1900	1900	1900	1900	1900	1900	1900	1900	1900	1900	1900	1900
Grade (%)		0%			0%			0%				3%
Storage Length (ft)	85		0	0		0	0		0	0		0
Storage Lanes	1		0	0		0	0		0	0		0
Taper Length (ft)	25			25			25			25		
Lane Util. Factor	1.00	1.00	1.00	1.00	1.00	1.00	1.00	1.00	1.00	1.00	1.00	1.00
Ped Bike Factor	0.98	0.95			0.98			0.87			0.94	
Frt		0.946			0.971			0.993			0.981	
Flt Protected	0.950				0.998			0.967			0.985	
Satd. Flow (prot)	1593	1514	0	0	1602	0	0	1597	0	0	1549	0
Flt Permitted	0.624				0.978			0.794			0.893	
Satd. Flow (perm)	1023	1514	0	0	1568	0	0	1156	0	0	1355	0
Right Turn on Red			No			No			No			No
Satd. Flow (RTOR)												
Link Speed (mph)		20			20			20			20	
Link Distance (ft)		496			1195			366			450	
Travel Time (s)		16.9			40.7			12.5			15.3	
Confl. Peds. (#/hr)	14		34	34		14	73		51	51		73
Peak Hour Factor	0.90	0.90	0.90	0.93	0.93	0.93	0.67	0.67	0.67	0.79	0.79	0.79
Adj. Flow (vph)	48	300	170	13	209	61	94	36	7	29	52	13
Shared Lane Traffic (%)												
Lane Group Flow (vph)	48	470	0	0	283	0	0	137	0	0	94	0
Turn Type	Perm	NA		Perm	NA		Perm	NA		Perm	NA	
Protected Phases		2			2			4			4	
Permitted Phases	2			2			4			4		
Detector Phase	2	2		2	2		4	4		4	4	
Switch Phase												
Minimum Initial (s)	11.0	11.0		11.0	11.0		8.0	8.0		8.0	8.0	
Minimum Split (s)	15.9	15.9		15.9	15.9		17.8	17.8		17.8	17.8	
Total Split (s)	32.0	32.0		32.0	32.0		38.0	38.0		38.0	38.0	
Total Split (%)	45.7%	45.7%		45.7%	45.7%		54.3%	54.3%		54.3%	54.3%	
Maximum Green (s)	27.1	27.1		27.1	27.1		33.2	33.2		33.2	33.2	
Yellow Time (s)	3.3	3.3		3.3	3.3		3.3	3.3		3.3	3.3	
All-Red Time (s)	1.6	1.6		1.6	1.6		1.5	1.5		1.5	1.5	
Lost Time Adjust (s)	0.1	0.0			0.1			0.2			0.2	
Total Lost Time (s)	5.0	4.9			5.0			5.0			5.0	
Lead/Lag												
Lead-Lag Optimize?												
Vehicle Extension (s)	2.0	2.0		2.0	2.0		2.0	2.0		2.0	2.0	
Recall Mode	C-Max	C-Max		C-Max	C-Max		None	None		None	None	
Walk Time (s)	4.0	4.0		4.0	4.0		4.0	4.0		4.0	4.0	
Flash Dont Walk (s)	7.0	7.0		7.0	7.0		9.0	9.0		9.0	9.0	
Pedestrian Calls (#/hr)	0	0		0	0		0	0		0	0	
Act Effct Green (s)	50.2	50.3			50.2			13.4			13.4	
Actuated g/C Ratio	0.72	0.72			0.72			0.19			0.19	
v/c Ratio	0.07	0.43			0.25			0.62			0.36	

Lanes, Volumes, Timings
 6: Henderson Street & E. Rosemary Street

2022 Build Alternative 1 PM Peak
 Timing Plan: PM Peak



Lane Group	EBL	EBT	EBR	WBL	WBT	WBR	NBL	NBT	NBR	SBL	SBT	SBR
Control Delay	5.9	7.1			5.2			28.6			26.9	
Queue Delay	0.0	0.0			0.0			0.0			0.0	
Total Delay	5.9	7.1			5.2			28.6			26.9	
LOS	A	A			A			C			C	
Approach Delay		7.0			5.2			28.6			26.9	
Approach LOS		A			A			C			C	
Queue Length 50th (ft)	6	72			54			52			36	
Queue Length 95th (ft)	m21	208			109			41			57	
Internal Link Dist (ft)		416			1115			286			370	
Turn Bay Length (ft)	85											
Base Capacity (vph)	733	1086			1124			544			638	
Starvation Cap Reductn	0	0			0			0			0	
Spillback Cap Reductn	0	0			0			0			0	
Storage Cap Reductn	0	0			0			0			0	
Reduced v/c Ratio	0.07	0.43			0.25			0.25			0.15	

Intersection Summary

Area Type: CBD
 Cycle Length: 70
 Actuated Cycle Length: 70
 Offset: 14 (20%), Referenced to phase 2:EBWB, Start of Green
 Natural Cycle: 50
 Control Type: Actuated-Coordinated
 Maximum v/c Ratio: 0.62
 Intersection Signal Delay: 11.2
 Intersection LOS: B
 Intersection Capacity Utilization 47.0%
 ICU Level of Service A
 Analysis Period (min) 15
 m Volume for 95th percentile queue is metered by upstream signal.

Splits and Phases: 6: Henderson Street & E. Rosemary Street

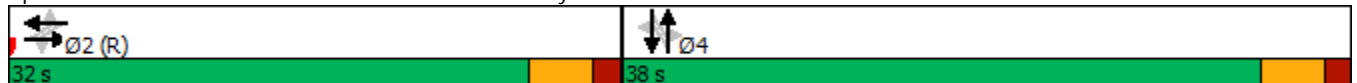

Lanes, Volumes, Timings
7: Hillsborough Street & E. Rosemary Street

2022 Build Alternative 1 PM Peak

Timing Plan: PM Peak



Lane Group	EBL	EBT	EBR	WBL	WBT	WBR	NBL	NBT	NBR	SBL	SBT	SBR
Lane Configurations		↕			↕		↗	↘		↗	↘	
Traffic Volume (vph)	39	135	62	10	99	56	162	295	23	37	203	27
Future Volume (vph)	39	135	62	10	99	56	162	295	23	37	203	27
Ideal Flow (vphpl)	1900	1900	1900	1900	1900	1900	1900	1900	1900	1900	1900	1900
Storage Length (ft)	0		0	0		0	100		0	100		0
Storage Lanes	0		0	0		0	1		0	1		0
Taper Length (ft)	25			25			25			25		
Lane Util. Factor	1.00	1.00	1.00	1.00	1.00	1.00	1.00	1.00	1.00	1.00	1.00	1.00
Ped Bike Factor		0.98			0.97		0.92	1.00		0.98	0.98	
Frt		0.965			0.954			0.989			0.982	
Flt Protected		0.992			0.997		0.950			0.950		
Satd. Flow (prot)	0	1759	0	0	1713	0	1770	1835	0	1770	1787	0
Flt Permitted		0.911			0.976		0.508			0.553		
Satd. Flow (perm)	0	1602	0	0	1675	0	869	1835	0	1010	1787	0
Right Turn on Red			No			No			No			No
Satd. Flow (RTOR)												
Link Speed (mph)		20			20			25			25	
Link Distance (ft)		1195			527			363			726	
Travel Time (s)		40.7			18.0			9.9			19.8	
Confl. Peds. (#/hr)	27		14	14		27	52		9	9		52
Peak Hour Factor	0.86	0.86	0.86	0.79	0.79	0.79	0.92	0.92	0.92	0.96	0.96	0.96
Adj. Flow (vph)	45	157	72	13	125	71	176	321	25	39	211	28
Shared Lane Traffic (%)												
Lane Group Flow (vph)	0	274	0	0	209	0	176	346	0	39	239	0
Turn Type	Perm	NA		Perm	NA		pm+pt	NA		Perm	NA	
Protected Phases		4			8		5	2			6	
Permitted Phases	4			8			2			6		
Detector Phase	4	4		8	8		5	2		6	6	
Switch Phase												
Minimum Initial (s)	7.0	7.0		7.0	7.0		7.0	10.0		10.0	10.0	
Minimum Split (s)	20.0	20.0		17.0	17.0		12.0	15.0		15.0	15.0	
Total Split (s)	30.0	30.0		30.0	30.0		14.0	40.0		26.0	26.0	
Total Split (%)	42.9%	42.9%		42.9%	42.9%		20.0%	57.1%		37.1%	37.1%	
Maximum Green (s)	25.1	25.1		25.0	25.0		9.2	35.2		21.2	21.2	
Yellow Time (s)	3.0	3.0		3.3	3.3		3.0	3.3		3.1	3.1	
All-Red Time (s)	1.9	1.9		1.7	1.7		1.8	1.5		1.7	1.7	
Lost Time Adjust (s)		0.1			0.0		0.2	0.2		0.2	0.2	
Total Lost Time (s)		5.0			5.0		5.0	5.0		5.0	5.0	
Lead/Lag							Lead			Lag	Lag	
Lead-Lag Optimize?												
Vehicle Extension (s)	2.0	2.0		2.0	2.0		2.0	2.0		2.0	2.0	
Recall Mode	None	None		None	None		None	C-Max		C-Max	C-Max	
Walk Time (s)	4.0	4.0		4.0	4.0			4.0		4.0	4.0	
Flash Dont Walk (s)	11.0	11.0		8.0	8.0			6.0		6.0	6.0	
Pedestrian Calls (#/hr)	0	0		0	0			0		0	0	
Act Effct Green (s)		16.2			16.2		43.8	43.8		30.8	30.8	
Actuated g/C Ratio		0.23			0.23		0.63	0.63		0.44	0.44	
v/c Ratio		0.74			0.54		0.27	0.30		0.09	0.30	
Control Delay		32.3			27.9		6.3	6.7		15.4	16.1	

Lanes, Volumes, Timings
7: Hillsborough Street & E. Rosemary Street

2022 Build Alternative 1 PM Peak

Timing Plan: PM Peak



Lane Group	EBL	EBT	EBR	WBL	WBT	WBR	NBL	NBT	NBR	SBL	SBT	SBR
Queue Delay		0.0			0.0		0.0	0.3		0.0	0.0	
Total Delay		32.3			27.9		6.3	7.0		15.4	16.1	
LOS		C			C		A	A		B	B	
Approach Delay		32.3			27.9			6.7			16.0	
Approach LOS		C			C			A			B	
Queue Length 50th (ft)		118			79		33	82		9	62	
Queue Length 95th (ft)		134			105		65	144		33	142	
Internal Link Dist (ft)		1115			447			283			646	
Turn Bay Length (ft)							100			100		
Base Capacity (vph)		572			598		664	1149		444	787	
Starvation Cap Reductn		0			0		0	348		0	0	
Spillback Cap Reductn		0			0		0	0		0	0	
Storage Cap Reductn		0			0		0	0		0	0	
Reduced v/c Ratio		0.48			0.35		0.27	0.43		0.09	0.30	

Intersection Summary

Area Type:	Other
Cycle Length:	70
Actuated Cycle Length:	70
Offset:	32 (46%), Referenced to phase 2:NBTL and 6:SBTL, Start of Green
Natural Cycle:	50
Control Type:	Actuated-Coordinated
Maximum v/c Ratio:	0.74
Intersection Signal Delay:	17.7
Intersection LOS:	B
Intersection Capacity Utilization	62.6%
ICU Level of Service	B
Analysis Period (min)	15

Splits and Phases: 7: Hillsborough Street & E. Rosemary Street



Lanes, Volumes, Timings

2022 Build Alternative 1 PM Peak

8: Carolina Square Driveway/Church Street & W. Franklin Street

Timing Plan: PM Peak

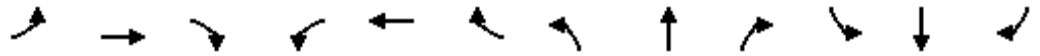

Lane Group	EBL	EBT	EBR	WBL	WBT	WBR	NBL	NBT	NBR	SBL	SBT	SBR
Lane Configurations												
Traffic Volume (vph)	65	462	18	41	566	72	24	48	40	73	59	75
Future Volume (vph)	65	462	18	41	566	72	24	48	40	73	59	75
Ideal Flow (vphpl)	1900	1900	1900	1900	1900	1900	1900	1900	1900	1900	1900	1900
Lane Width (ft)	10	10	16	10	10	10	12	12	12	12	12	12
Grade (%)		2%			-2%			-4%			-3%	
Storage Length (ft)	150		0	200		0	0		100	0		0
Storage Lanes	1		0	1		0	0		1	0		0
Taper Length (ft)	25			25			25			25		
Lane Util. Factor	1.00	1.00	1.00	1.00	1.00	1.00	1.00	1.00	1.00	1.00	1.00	1.00
Ped Bike Factor		0.99		0.88	0.96			0.94	0.88		0.86	
Frt		0.994			0.983				0.850		0.951	
Flt Protected	0.950			0.950				0.983			0.983	
Satd. Flow (prot)	1457	1503	0	1501	1493	0	0	1681	1454	0	1415	0
Flt Permitted	0.286			0.394				0.866			0.851	
Satd. Flow (perm)	439	1503	0	546	1493	0	0	1387	1282	0	1187	0
Right Turn on Red			No			No			No			No
Satd. Flow (RTOR)												
Link Speed (mph)		20			20			20			25	
Link Distance (ft)		993			294			285			379	
Travel Time (s)		33.9			10.0			9.7			10.3	
Confl. Peds. (#/hr)	124		164	164		124	175		63	63		175
Peak Hour Factor	0.91	0.91	0.91	0.93	0.93	0.93	0.81	0.81	0.81	0.91	0.91	0.91
Heavy Vehicles (%)	3%	3%	3%	2%	2%	2%	2%	2%	2%	2%	2%	2%
Adj. Flow (vph)	71	508	20	44	609	77	30	59	49	80	65	82
Shared Lane Traffic (%)												
Lane Group Flow (vph)	71	528	0	44	686	0	0	89	49	0	227	0
Turn Type	Perm	NA		Perm	NA		Perm	NA	Perm	Perm	NA	
Protected Phases		2			6			8			4	
Permitted Phases	2			6			8		8	4		
Detector Phase	2	2		6	6		8	8	8	4	4	
Switch Phase												
Minimum Initial (s)	10.0	10.0		10.0	10.0		7.0	7.0	7.0	7.0	7.0	
Minimum Split (s)	22.0	22.0		19.0	19.0		29.0	29.0	29.0	27.0	27.0	
Total Split (s)	41.0	41.0		41.0	41.0		29.0	29.0	29.0	29.0	29.0	
Total Split (%)	58.6%	58.6%		58.6%	58.6%		41.4%	41.4%	41.4%	41.4%	41.4%	
Maximum Green (s)	35.4	35.4		35.4	35.4		22.7	22.7	22.7	23.0	23.0	
Yellow Time (s)	3.3	3.3		3.3	3.3		3.1	3.1	3.1	3.4	3.4	
All-Red Time (s)	2.3	2.3		2.3	2.3		3.2	3.2	3.2	2.6	2.6	
Lost Time Adjust (s)	-0.6	-0.6		-0.6	-0.6		-1.3	-1.3	-1.3	-1.0	-1.0	
Total Lost Time (s)	5.0	5.0		5.0	5.0		5.0	5.0	5.0	5.0	5.0	
Lead/Lag												
Lead-Lag Optimize?												
Vehicle Extension (s)	3.0	3.0		3.0	3.0		2.0	2.0	2.0	2.0	2.0	
Recall Mode	C-Max	C-Max		C-Max	C-Max		None	None	None	None	None	
Walk Time (s)	7.0	7.0		7.0	7.0		7.0	7.0	7.0	7.0	7.0	
Flash Dont Walk (s)	9.0	9.0		6.0	6.0		15.0	15.0	15.0	14.0	14.0	
Pedestrian Calls (#/hr)	0	0		0	0		0	0	0	0	0	
Act Effect Green (s)	42.0	42.0		42.0	42.0		18.0	18.0	18.0	18.0	18.0	

Lanes, Volumes, Timings
 8: Carolina Square Driveway/Church Street & W. Franklin Street

2022 Build Alternative 1 PM Peak

Timing Plan: PM Peak



Lane Group	EBL	EBT	EBR	WBL	WBT	WBR	NBL	NBT	NBR	SBL	SBT	SBR
Actuated g/C Ratio	0.60	0.60		0.60	0.60			0.26	0.26		0.26	
v/c Ratio	0.27	0.59		0.13	0.77			0.25	0.15		0.74	
Control Delay	12.2	13.5		10.0	17.5			20.4	18.8		35.7	
Queue Delay	0.0	0.0		0.0	0.0			0.0	0.0		0.0	
Total Delay	12.2	13.5		10.0	17.5			20.4	18.8		35.7	
LOS	B	B		A	B			C	B		D	
Approach Delay		13.4			17.0			19.8			35.7	
Approach LOS		B			B			B			D	
Queue Length 50th (ft)	13	128		15	323			30	16		103	
Queue Length 95th (ft)	46	268		m18	m325			51	32		112	
Internal Link Dist (ft)		913			214			205			299	
Turn Bay Length (ft)	150			200					100			
Base Capacity (vph)	263	900		327	894			475	439		406	
Starvation Cap Reductn	0	0		0	0			0	0		0	
Spillback Cap Reductn	0	0		0	0			0	0		0	
Storage Cap Reductn	0	0		0	0			0	0		0	
Reduced v/c Ratio	0.27	0.59		0.13	0.77			0.19	0.11		0.56	

Intersection Summary

Area Type: CBD
 Cycle Length: 70
 Actuated Cycle Length: 70
 Offset: 66 (94%), Referenced to phase 2:EBTL and 6:WBTL, Start of Green
 Natural Cycle: 70
 Control Type: Actuated-Coordinated
 Maximum v/c Ratio: 0.77
 Intersection Signal Delay: 18.5 Intersection LOS: B
 Intersection Capacity Utilization 81.9% ICU Level of Service D
 Analysis Period (min) 15
 m Volume for 95th percentile queue is metered by upstream signal.

Splits and Phases: 8: Carolina Square Driveway/Church Street & W. Franklin Street

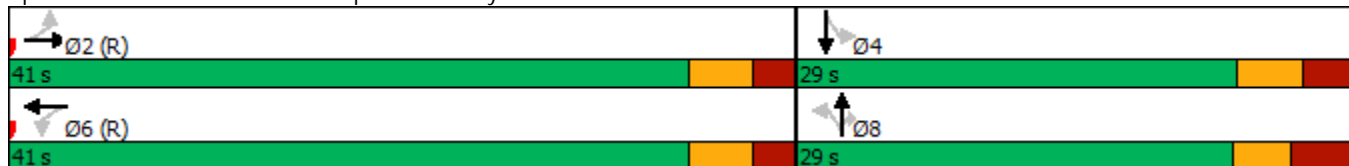

Lanes, Volumes, Timings

2022 Build Alternative 1 PM Peak

9: NC 86 (S. Columbia St)/NC 86 (N. Columbia St) & W. Franklin Street/E. Franklin Street PM Peak

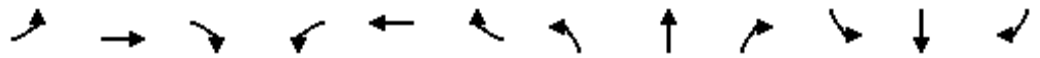

Lane Group	EBL	EBT	EBR	WBL	WBT	WBR	NBL	NBT	NBR	SBL	SBT	SBR
Lane Configurations												
Traffic Volume (vph)	177	430	75	101	514	66	64	561	112	73	417	120
Future Volume (vph)	177	430	75	101	514	66	64	561	112	73	417	120
Ideal Flow (vphpl)	1900	1900	1900	1900	1900	1900	1900	1900	1900	1900	1900	1900
Lane Width (ft)	9	12	13	10	10	13	9	10	10	9	9	11
Grade (%)		3%			1%			-2%			3%	
Storage Length (ft)	250		0	125		0	475		0	125		0
Storage Lanes	1		0	1		1	1		0	1		0
Taper Length (ft)	25			25			25			25		
Lane Util. Factor	1.00	0.95	0.95	1.00	1.00	1.00	1.00	0.95	0.95	1.00	0.95	0.95
Ped Bike Factor	0.87	0.96		0.87		0.68	0.90	0.96		0.93	0.95	
Frt		0.978				0.850		0.975			0.966	
Flt Protected	0.950			0.950			0.950			0.950		
Satd. Flow (prot)	1412	2934	0	1479	1557	1465	1380	2692	0	1385	2538	0
Flt Permitted	0.950			0.950			0.950			0.950		
Satd. Flow (perm)	1223	2934	0	1287	1557	997	1247	2692	0	1284	2538	0
Right Turn on Red			No			No			No			No
Satd. Flow (RTOR)												
Link Speed (mph)		20			20			25			25	
Link Distance (ft)		461			941			981			353	
Travel Time (s)		15.7			32.1			26.8			9.6	
Confl. Peds. (#/hr)	193		152	152		193	67		108	108		67
Peak Hour Factor	0.87	0.87	0.87	0.84	0.84	0.84	0.90	0.90	0.90	0.94	0.94	0.94
Heavy Vehicles (%)	2%	2%	2%	2%	2%	2%	7%	7%	7%	4%	4%	4%
Adj. Flow (vph)	203	494	86	120	612	79	71	623	124	78	444	128
Shared Lane Traffic (%)												
Lane Group Flow (vph)	203	580	0	120	612	79	71	747	0	78	572	0
Turn Type	Prot	NA		Prot	NA	pm+ov	Prot	NA		Prot	NA	
Protected Phases	5	2		1	6	7	3	8		7	4	
Permitted Phases						6						
Detector Phase	5	2		1	6	7	3	8		7	4	
Switch Phase												
Minimum Initial (s)	7.0	10.0		7.0	10.0	7.0	7.0	7.0		7.0	7.0	
Minimum Split (s)	15.0	28.2		15.0	28.2	15.0	15.0	28.0		15.0	28.1	
Total Split (s)	22.0	36.0		43.0	57.0	15.0	21.0	46.0		15.0	40.0	
Total Split (%)	15.7%	25.7%		30.7%	40.7%	10.7%	15.0%	32.9%		10.7%	28.6%	
Maximum Green (s)	16.6	29.8		37.1	50.8	9.1	15.1	40.1		9.1	34.3	
Yellow Time (s)	3.0	3.0		3.0	3.0	3.0	3.0	3.3		3.0	3.1	
All-Red Time (s)	2.4	3.2		2.9	3.2	2.9	2.9	2.6		2.9	2.6	
Lost Time Adjust (s)	-0.4	-1.2		-0.9	-1.2	-2.0	-0.9	-0.9		-0.9	-0.7	
Total Lost Time (s)	5.0	5.0		5.0	5.0	3.9	5.0	5.0		5.0	5.0	
Lead/Lag	Lead	Lag		Lead	Lag	Lead	Lead	Lag		Lead	Lag	
Lead-Lag Optimize?	Yes	Yes		Yes	Yes	Yes	Yes	Yes		Yes	Yes	
Vehicle Extension (s)	1.0	3.0		1.0	3.0	1.0	1.0	2.0		1.0	2.0	
Recall Mode	None	C-Max		None	C-Max	None	None	Ped		None	Ped	
Walk Time (s)		7.0			7.0			7.0			7.0	
Flash Dont Walk (s)		15.0			15.0			15.0			15.0	
Pedestrian Calls (#/hr)		0			0			0			0	
Act Effect Green (s)	18.0	54.2		15.8	52.0	63.8	11.7	40.4		9.6	40.9	

Lanes, Volumes, Timings

2022 Build Alternative 1 PM Peak

9: NC 86 (S. Columbia St)/NC 86 (N. Columbia St) & W. Franklin Street/E. Franklin Street



Lane Group	EBL	EBT	EBR	WBL	WBT	WBR	NBL	NBT	NBR	SBL	SBT	SBR
Actuated g/C Ratio	0.13	0.39		0.11	0.37	0.46	0.08	0.29		0.07	0.29	
v/c Ratio	1.12	0.51		0.72	1.06	0.16	0.62	0.96		0.83	0.77	
Control Delay	152.0	36.0		94.1	89.0	21.4	101.0	25.0		127.2	36.8	
Queue Delay	0.0	0.0		0.0	0.0	0.0	0.0	0.7		0.0	0.8	
Total Delay	152.0	36.0		94.1	89.0	21.4	101.0	25.7		127.2	37.7	
LOS	F	D		F	F	C	F	C		F	D	
Approach Delay		66.1			83.2			32.2			48.4	
Approach LOS		E			F			C			D	
Queue Length 50th (ft)	~224	197		112	-628	31	62	236		75	122	
Queue Length 95th (ft)	#367	297		167	#770	53	m60	m175		m#167	#359	
Internal Link Dist (ft)		381			861			901			273	
Turn Bay Length (ft)	250			125			475			125		
Base Capacity (vph)	181	1135		401	578	494	157	788		98	741	
Starvation Cap Reductn	0	0		0	0	0	0	0		0	39	
Spillback Cap Reductn	0	0		0	0	0	0	5		0	0	
Storage Cap Reductn	0	0		0	0	0	0	0		0	0	
Reduced v/c Ratio	1.12	0.51		0.30	1.06	0.16	0.45	0.95		0.80	0.81	

Intersection Summary

Area Type: CBD
 Cycle Length: 140
 Actuated Cycle Length: 140
 Offset: 0 (0%), Referenced to phase 2:EBT and 6:WBT, Start of Green
 Natural Cycle: 150
 Control Type: Actuated-Coordinated
 Maximum v/c Ratio: 1.12
 Intersection Signal Delay: 57.8 Intersection LOS: E
 Intersection Capacity Utilization 85.7% ICU Level of Service E
 Analysis Period (min) 15
 ~ Volume exceeds capacity, queue is theoretically infinite.
 Queue shown is maximum after two cycles.
 # 95th percentile volume exceeds capacity, queue may be longer.
 Queue shown is maximum after two cycles.
 m Volume for 95th percentile queue is metered by upstream signal.

Splits and Phases: 9: NC 86 (S. Columbia St)/NC 86 (N. Columbia St) & W. Franklin Street/E. Franklin Street

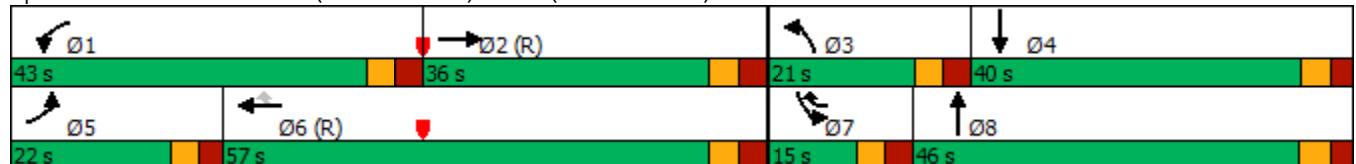

Lanes, Volumes, Timings
10: E. Franklin Street & Henderson Street

2022 Build Alternative 1 PM Peak

Timing Plan: PM Peak



Lane Group	EBL	EBT	WBT	WBR	SBL	SBR
Lane Configurations		↕↕	↕↔		↔↕	
Traffic Volume (vph)	34	601	648	67	150	57
Future Volume (vph)	34	601	648	67	150	57
Ideal Flow (vphpl)	1900	1900	1900	1900	1900	1900
Lane Width (ft)	10	13	10	10	11	11
Grade (%)		-2%	2%		3%	
Lane Util. Factor	0.95	0.95	0.95	0.95	1.00	1.00
Ped Bike Factor		1.00	0.97		0.87	
Frt			0.986		0.963	
Flt Protected		0.997			0.965	
Satd. Flow (prot)	0	3282	2826	0	1391	0
Flt Permitted		0.885			0.965	
Satd. Flow (perm)	0	2901	2826	0	1293	0
Right Turn on Red				No		No
Satd. Flow (RTOR)						
Link Speed (mph)		20	20		20	
Link Distance (ft)		941	1200		366	
Travel Time (s)		32.1	40.9		12.5	
Confl. Peds. (#/hr)	114			114	88	198
Peak Hour Factor	0.90	0.90	0.93	0.93	0.83	0.83
Heavy Vehicles (%)	3%	3%	2%	2%	2%	2%
Parking (#/hr)						0
Adj. Flow (vph)	38	668	697	72	181	69
Shared Lane Traffic (%)						
Lane Group Flow (vph)	0	706	769	0	250	0
Turn Type	Perm	NA	NA		Prot	
Protected Phases		2	6		4	
Permitted Phases	2					
Detector Phase	2	2	6		4	
Switch Phase						
Minimum Initial (s)	10.0	10.0	10.0		7.0	
Minimum Split (s)	16.2	16.2	21.1		24.1	
Total Split (s)	43.0	43.0	43.0		27.0	
Total Split (%)	61.4%	61.4%	61.4%		38.6%	
Maximum Green (s)	36.8	36.8	36.9		21.9	
Yellow Time (s)	3.0	3.0	3.0		3.0	
All-Red Time (s)	3.2	3.2	3.1		2.1	
Lost Time Adjust (s)		-1.2	-1.1		-0.1	
Total Lost Time (s)		5.0	5.0		5.0	
Lead/Lag						
Lead-Lag Optimize?						
Vehicle Extension (s)	2.0	2.0	2.0		1.0	
Recall Mode	C-Max	C-Max	C-Max		None	
Walk Time (s)			7.0		7.0	
Flash Dont Walk (s)			8.0		12.0	
Pedestrian Calls (#/hr)			0		0	
Act Effct Green (s)		44.1	44.1		15.9	
Actuated g/C Ratio		0.63	0.63		0.23	
v/c Ratio		0.39	0.43		0.79	

Lanes, Volumes, Timings
 10: E. Franklin Street & Henderson Street

2022 Build Alternative 1 PM Peak
 Timing Plan: PM Peak

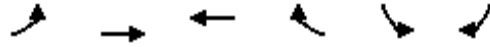

Lane Group	EBL	EBT	WBT	WBR	SBL	SBR
Control Delay		9.0	5.3		41.8	
Queue Delay		0.0	0.0		0.0	
Total Delay		9.0	5.3		41.8	
LOS		A	A		D	
Approach Delay		9.0	5.3		41.8	
Approach LOS		A	A		D	
Queue Length 50th (ft)		187	69		104	
Queue Length 95th (ft)		m180	135		121	
Internal Link Dist (ft)		861	1120		286	
Turn Bay Length (ft)						
Base Capacity (vph)		1827	1780		437	
Starvation Cap Reductn		0	0		0	
Spillback Cap Reductn		0	0		0	
Storage Cap Reductn		0	0		0	
Reduced v/c Ratio		0.39	0.43		0.57	

Intersection Summary

Area Type: CBD
 Cycle Length: 70
 Actuated Cycle Length: 70
 Offset: 27 (39%), Referenced to phase 2:EBTL and 6:WBT, Start of Green
 Natural Cycle: 50
 Control Type: Actuated-Coordinated
 Maximum v/c Ratio: 0.79
 Intersection Signal Delay: 12.1
 Intersection LOS: B
 Intersection Capacity Utilization 70.8%
 ICU Level of Service C
 Analysis Period (min) 15
 m Volume for 95th percentile queue is metered by upstream signal.

Splits and Phases: 10: E. Franklin Street & Henderson Street

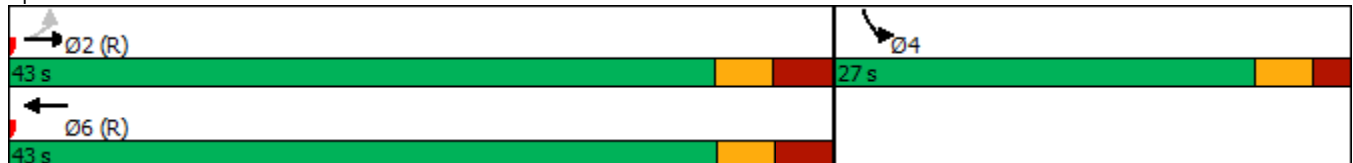

Lanes, Volumes, Timings

2022 Build Alternative 1 PM Peak

11: Raleigh Street/Hillsborough Street & E. Franklin Street

Timing Plan: PM Peak

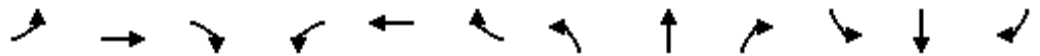

Lane Group	EBL	EBT	EBR	WBL	WBT	WBR	NBL	NBT	NBR	SBL	SBT	SBR
Lane Configurations												
Traffic Volume (vph)	51	540	232	62	662	240	50	197	23	54	201	13
Future Volume (vph)	51	540	232	62	662	240	50	197	23	54	201	13
Ideal Flow (vphpl)	1900	1900	1900	1900	1900	1900	1900	1900	1900	1900	1900	1900
Lane Width (ft)	9	9	10	9	10	11	12	12	12	10	10	10
Grade (%)		1%			-2%			1%			1%	
Storage Length (ft)	75		0	75		0	0		0	100		0
Storage Lanes	1		0	1		0	0		0	1		0
Taper Length (ft)	25			25			25			25		
Lane Util. Factor	1.00	0.95	0.95	1.00	0.95	0.95	1.00	1.00	1.00	1.00	1.00	1.00
Ped Bike Factor	1.00	0.99		1.00	0.99			0.99		0.99	0.99	
Frt		0.955			0.960			0.988			0.991	
Flt Protected	0.950			0.950				0.991		0.950		
Satd. Flow (prot)	1585	2995	0	1609	3173	0	0	1811	0	1643	1702	0
Flt Permitted	0.251			0.298				0.700		0.399		
Satd. Flow (perm)	417	2995	0	502	3173	0	0	1267	0	686	1702	0
Right Turn on Red			No			No			No			No
Satd. Flow (RTOR)												
Link Speed (mph)		20			30			25			25	
Link Distance (ft)		1200			1013			995			363	
Travel Time (s)		40.9			23.0			27.1			9.9	
Confl. Peds. (#/hr)	16		16	16		16	58		7	7		58
Peak Hour Factor	0.91	0.91	0.91	0.92	0.92	0.92	0.93	0.93	0.93	0.88	0.88	0.88
Adj. Flow (vph)	56	593	255	67	720	261	54	212	25	61	228	15
Shared Lane Traffic (%)												
Lane Group Flow (vph)	56	848	0	67	981	0	0	291	0	61	243	0
Turn Type	Perm	NA		Perm	NA		pm+pt	NA		D.Pm	NA	
Protected Phases		2			6		7	4				8
Permitted Phases	2			6			4			4		
Detector Phase	2	2		6	6		7	4		4		8
Switch Phase												
Minimum Initial (s)	10.0	10.0		10.0	10.0		7.0	7.0		7.0	7.0	
Minimum Split (s)	16.0	16.0		16.0	16.0		14.0	30.0		30.0	29.0	
Total Split (s)	79.0	79.0		79.0	79.0		14.0	61.0		61.0	47.0	
Total Split (%)	56.4%	56.4%		56.4%	56.4%		10.0%	43.6%		43.6%	33.6%	
Maximum Green (s)	73.7	73.7		73.7	73.7		7.8	54.6		54.6	40.6	
Yellow Time (s)	3.0	3.0		3.0	3.0		3.0	3.1		3.1	3.1	
All-Red Time (s)	2.3	2.3		2.3	2.3		3.2	3.3		3.3	3.3	
Lost Time Adjust (s)	-0.3	-0.3		-0.3	-0.3			-1.4		-1.4	-1.4	
Total Lost Time (s)	5.0	5.0		5.0	5.0			5.0		5.0	5.0	
Lead/Lag							Lead				Lag	
Lead-Lag Optimize?												
Vehicle Extension (s)	3.0	3.0		3.0	3.0		3.0	2.0		2.0	2.0	
Recall Mode	C-Max	C-Max		C-Max	C-Max		None	None		None	None	
Walk Time (s)								7.0		7.0	7.0	
Flash Dont Walk (s)								16.0		16.0	15.0	
Pedestrian Calls (#/hr)								0		0	0	
Act Effect Green (s)	94.4	94.4		94.4	94.4			35.6		35.6	35.6	
Actuated g/C Ratio	0.67	0.67		0.67	0.67			0.25		0.25	0.25	

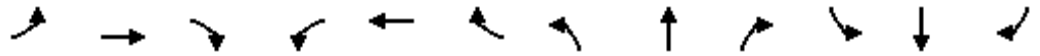

Lane Group	EBL	EBT	EBR	WBL	WBT	WBR	NBL	NBT	NBR	SBL	SBT	SBR
v/c Ratio	0.20	0.42		0.20	0.46			0.90		0.35	0.56	
Control Delay	6.0	4.9		12.5	12.7			80.4		40.4	43.2	
Queue Delay	0.0	0.0		0.0	0.0			0.0		0.0	0.9	
Total Delay	6.0	4.9		12.5	12.7			80.4		40.4	44.1	
LOS	A	A		B	B			F		D	D	
Approach Delay		4.9			12.7			80.4			43.4	
Approach LOS		A			B			F			D	
Queue Length 50th (ft)	8	68		21	206			258		43	171	
Queue Length 95th (ft)	m20	99		57	321			341		72	214	
Internal Link Dist (ft)		1120			933			915			283	
Turn Bay Length (ft)	75			75						100		
Base Capacity (vph)	280	2018		338	2138			506		274	522	
Starvation Cap Reductn	0	0		0	0			0		0	105	
Spillback Cap Reductn	0	0		0	0			0		0	0	
Storage Cap Reductn	0	0		0	0			0		0	0	
Reduced v/c Ratio	0.20	0.42		0.20	0.46			0.58		0.22	0.58	

Intersection Summary

Area Type: Other
 Cycle Length: 140
 Actuated Cycle Length: 140
 Offset: 73 (52%), Referenced to phase 2:EBTL and 6:WBTL, Start of Green
 Natural Cycle: 70
 Control Type: Actuated-Coordinated
 Maximum v/c Ratio: 0.90
 Intersection Signal Delay: 21.3
 Intersection LOS: C
 Intersection Capacity Utilization 84.3%
 ICU Level of Service E
 Analysis Period (min) 15
 m Volume for 95th percentile queue is metered by upstream signal.

Splits and Phases: 11: Raleigh Street/Hillsborough Street & E. Franklin Street

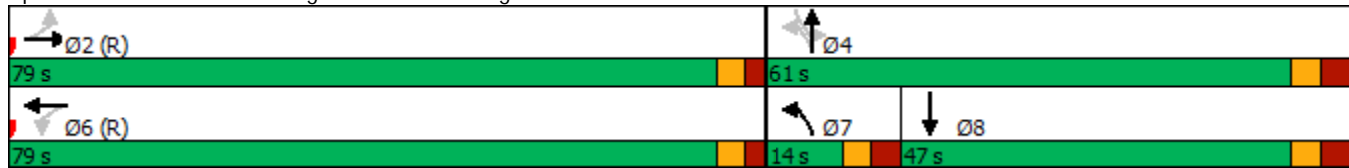

Lanes, Volumes, Timings

2022 Build Alternative 1 PM Peak

14: NC 86 (MLK Jr. Blvd) & Longview Street/Mill Creek Apts Driveway

Timing Plan: PM Peak

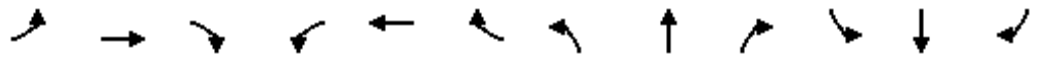

Lane Group	EBL	EBT	EBR	WBL	WBT	WBR	NBL	NBT	NBR	SBL	SBT	SBR
Lane Configurations		↕			↕		↕	↕		↕	↕	
Traffic Volume (vph)	96	2	18	34	1	8	14	920	13	11	659	77
Future Volume (vph)	96	2	18	34	1	8	14	920	13	11	659	77
Ideal Flow (vphpl)	1900	1900	1900	1900	1900	1900	1900	1900	1900	1900	1900	1900
Grade (%)		-6%			1%			2%			-4%	
Storage Length (ft)	0		0	0		0	225		0	250		0
Storage Lanes	0		0	0		0	1		0	1		0
Taper Length (ft)	25			25			25			25		
Lane Util. Factor	1.00	1.00	1.00	1.00	1.00	1.00	1.00	0.95	0.95	1.00	0.95	0.95
Ped Bike Factor		0.99			0.99		0.99	1.00		0.99	1.00	
Frt		0.979			0.974			0.998			0.984	
Flt Protected		0.960			0.962		0.950			0.950		
Satd. Flow (prot)	0	1794	0	0	1732	0	1735	3459	0	1787	3504	0
Flt Permitted		0.723			0.754		0.343			0.226		
Satd. Flow (perm)	0	1349	0	0	1341	0	623	3459	0	420	3504	0
Right Turn on Red			No			No			No			No
Satd. Flow (RTOR)												
Link Speed (mph)		25			20			35			35	
Link Distance (ft)		451			338			2108			784	
Travel Time (s)		12.3			11.5			41.1			15.3	
Confl. Peds. (#/hr)	2		20	20		2	7		28	28		7
Peak Hour Factor	0.89	0.89	0.89	0.75	0.75	0.75	0.86	0.86	0.86	0.93	0.93	0.93
Heavy Vehicles (%)	2%	2%	2%	2%	2%	2%	3%	3%	3%	3%	3%	3%
Adj. Flow (vph)	108	2	20	45	1	11	16	1070	15	12	709	83
Shared Lane Traffic (%)												
Lane Group Flow (vph)	0	130	0	0	57	0	16	1085	0	12	792	0
Turn Type	Perm	NA		Perm	NA		Perm	NA		Perm	NA	
Protected Phases		4			8			2			6	
Permitted Phases	4			8			2			6		
Detector Phase	4	4		8	8		2	2		6	6	
Switch Phase												
Minimum Initial (s)	7.0	7.0		7.0	7.0		12.0	12.0		12.0	12.0	
Minimum Split (s)	31.0	31.0		14.0	14.0		28.0	28.0		28.0	28.0	
Total Split (s)	20.0	20.0		20.0	20.0		60.0	60.0		60.0	60.0	
Total Split (%)	25.0%	25.0%		25.0%	25.0%		75.0%	75.0%		75.0%	75.0%	
Maximum Green (s)	14.0	14.0		13.9	13.9		54.0	54.0		54.5	54.5	
Yellow Time (s)	3.5	3.5		3.0	3.0		4.5	4.5		4.0	4.0	
All-Red Time (s)	2.5	2.5		3.1	3.1		1.5	1.5		1.5	1.5	
Lost Time Adjust (s)		-1.0			-1.0		-1.0	-1.0		-0.5	-0.5	
Total Lost Time (s)		5.0			5.1		5.0	5.0		5.0	5.0	
Lead/Lag												
Lead-Lag Optimize?												
Vehicle Extension (s)	3.0	3.0		3.0	3.0		3.0	3.0		3.0	3.0	
Recall Mode	None	None		None	None		Min	Min		Min	Min	
Walk Time (s)	7.0	7.0					7.0	7.0		7.0	7.0	
Flash Dont Walk (s)	17.0	17.0					9.0	9.0		9.0	9.0	
Pedestrian Calls (#/hr)	0	0					0	0		0	0	
Act Effct Green (s)		10.9			10.8		28.3	28.3		28.3	28.3	
Actuated g/C Ratio		0.24			0.24		0.63	0.63		0.63	0.63	

Lanes, Volumes, Timings

2022 Build Alternative 1 PM Peak

14: NC 86 (MLK Jr. Blvd) & Longview Street/Mill Creek Apts Driveway

Timing Plan: PM Peak

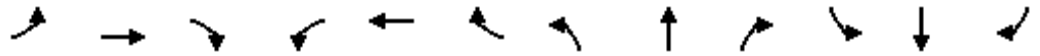

Lane Group	EBL	EBT	EBR	WBL	WBT	WBR	NBL	NBT	NBR	SBL	SBT	SBR
v/c Ratio		0.40			0.18		0.04	0.50		0.05	0.36	
Control Delay		20.2			17.0		5.7	7.5		6.0	6.4	
Queue Delay		0.0			0.0		0.0	0.0		0.0	0.0	
Total Delay		20.2			17.0		5.7	7.5		6.0	6.4	
LOS		C			B		A	A		A	A	
Approach Delay		20.2			17.0			7.5			6.4	
Approach LOS		C			B			A			A	
Queue Length 50th (ft)		28			12		2	83		1	54	
Queue Length 95th (ft)		78			33		9	144		8	102	
Internal Link Dist (ft)		371			258			2028			704	
Turn Bay Length (ft)							225			250		
Base Capacity (vph)		470			464		616	3422		415	3467	
Starvation Cap Reductn		0			0		0	0		0	0	
Spillback Cap Reductn		0			0		0	0		0	0	
Storage Cap Reductn		0			0		0	0		0	0	
Reduced v/c Ratio		0.28			0.12		0.03	0.32		0.03	0.23	

Intersection Summary

Area Type:	Other
Cycle Length:	80
Actuated Cycle Length:	44.7
Natural Cycle:	60
Control Type:	Actuated-Uncoordinated
Maximum v/c Ratio:	0.50
Intersection Signal Delay:	8.1
Intersection LOS:	A
Intersection Capacity Utilization:	47.8%
ICU Level of Service:	A
Analysis Period (min):	15

Splits and Phases: 14: NC 86 (MLK Jr. Blvd) & Longview Street/Mill Creek Apts Driveway

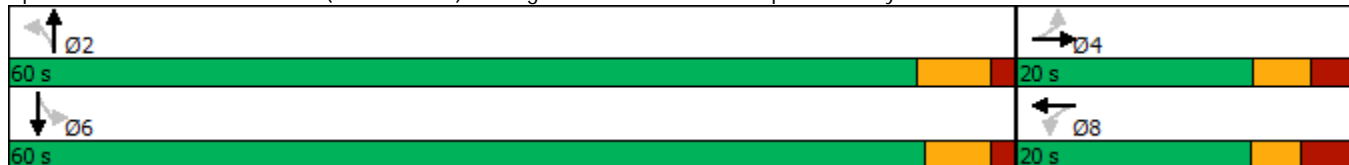

Lanes, Volumes, Timings
 15: NC 86 (Pittsboro St) & W. Cameron Avenue

2022 Build Alternative 1 PM Peak

Timing Plan: PM Peak

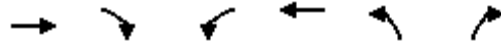

Lane Group	EBT	EBR	WBL	WBT	NBL	NBR	Ø1	Ø4
Lane Configurations	↻		↻↻	↻				
Traffic Volume (vph)	148	220	544	359	0	0		
Future Volume (vph)	148	220	544	359	0	0		
Ideal Flow (vphpl)	1900	1900	1900	1900	1900	1900		
Lane Width (ft)	12	12	11	12	12	12		
Grade (%)	3%			-3%	0%			
Storage Length (ft)		0	75		0	0		
Storage Lanes		0	0		0	0		
Taper Length (ft)			25		25			
Lane Util. Factor	1.00	1.00	0.97	1.00	1.00	1.00		
Ped Bike Factor	0.84		0.74					
Frt	0.919							
Flt Protected			0.950					
Satd. Flow (prot)	1269	0	2890	1622	0	0		
Flt Permitted			0.950					
Satd. Flow (perm)	1269	0	2147	1622	0	0		
Right Turn on Red		No				No		
Satd. Flow (RTOR)								
Link Speed (mph)	25			25	25			
Link Distance (ft)	391			120	794			
Travel Time (s)	30.0			10.7	21.7			
Confl. Peds. (#/hr)		70	70					
Peak Hour Factor	0.93	0.93	0.96	0.96	0.90	0.90		
Heavy Vehicles (%)	2%	2%	7%	7%	2%	2%		
Adj. Flow (vph)	159	237	567	374	0	0		
Shared Lane Traffic (%)								
Lane Group Flow (vph)	396	0	567	374	0	0		
Turn Type	NA		Prot	NA				
Protected Phases	2		1 4	6			1	4
Permitted Phases								
Detector Phase	2		1 4	6				
Switch Phase								
Minimum Initial (s)	10.0			10.0			7.0	7.0
Minimum Split (s)	20.1			20.0			20.0	21.0
Total Split (s)	44.0			102.0			58.0	38.0
Total Split (%)	31.4%			72.9%			41%	27%
Maximum Green (s)	38.9			97.0			52.9	34.0
Yellow Time (s)	3.0			3.3			3.0	3.0
All-Red Time (s)	2.1			1.7			2.1	1.0
Lost Time Adjust (s)	-0.1			0.0				
Total Lost Time (s)	5.0			5.0				
Lead/Lag	Lead						Lag	
Lead-Lag Optimize?								
Vehicle Extension (s)	1.0			1.0			4.0	0.2
Recall Mode	None			C-Max			C-Max	None
Walk Time (s)	7.0							7.0
Flash Dont Walk (s)	4.0							9.0
Pedestrian Calls (#/hr)	0							0
Act Effect Green (s)	57.0		73.0	124.0				

Lanes, Volumes, Timings
 15: NC 86 (Pittsboro St) & W. Cameron Avenue

2022 Build Alternative 1 PM Peak
 Timing Plan: PM Peak



Lane Group	EBT	EBR	WBL	WBT	NBL	NBR	Ø1	Ø4
Actuated g/C Ratio	0.41		0.52	0.89				
v/c Ratio	0.77		0.38	0.26				
Control Delay	48.1		13.4	0.8				
Queue Delay	0.0		0.1	0.7				
Total Delay	48.1		13.5	1.6				
LOS	D		B	A				
Approach Delay	48.1			8.7				
Approach LOS	D			A				
Queue Length 50th (ft)	324		80	6				
Queue Length 95th (ft)	447		m113	m38				
Internal Link Dist (ft)	311			40	714			
Turn Bay Length (ft)			75					
Base Capacity (vph)	517		2063	1436				
Starvation Cap Reductn	0		515	734				
Spillback Cap Reductn	0		0	0				
Storage Cap Reductn	0		0	0				
Reduced v/c Ratio	0.77		0.37	0.53				

Intersection Summary

Area Type: CBD
 Cycle Length: 140
 Actuated Cycle Length: 140
 Offset: 104 (74%), Referenced to phase 1:WBL and 6:WBT, Start of Green
 Natural Cycle: 70
 Control Type: Actuated-Coordinated
 Maximum v/c Ratio: 0.77
 Intersection Signal Delay: 20.4
 Intersection LOS: C
 Intersection Capacity Utilization 52.2%
 ICU Level of Service A
 Analysis Period (min) 15
 m Volume for 95th percentile queue is metered by upstream signal.

Splits and Phases: 15: NC 86 (Pittsboro St) & W. Cameron Avenue



Lanes, Volumes, Timings

2022 Build Alternative 1 PM Peak

16: NC 86 (S. Columbia St) & W. Cameron Avenue/E. Cameron Avenue

Timing Plan: PM Peak

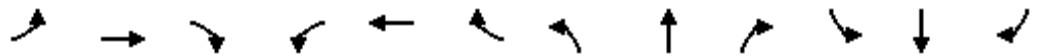

Lane Group	EBL	EBT	EBR	WBL	WBT	WBR	NBL	NBT	NBR	SBL	SBT	SBR
Lane Configurations												
Traffic Volume (vph)	20	122	0	0	166	51	220	664	59	119	0	504
Future Volume (vph)	20	122	0	0	166	51	220	664	59	119	0	504
Ideal Flow (vphpl)	1900	1900	1900	1900	1900	1900	1900	1900	1900	1900	1900	1900
Lane Width (ft)	11	12	12	12	12	12	10	10	10	11	11	12
Grade (%)		1%			-1%			1%			2%	
Storage Length (ft)	100		0	0		0	0		0	310		0
Storage Lanes	1		0	0		0	1		0	1		2
Taper Length (ft)	25			25			25			25		
Lane Util. Factor	1.00	1.00	1.00	1.00	1.00	1.00	0.91	0.91	0.95	1.00	1.00	0.88
Ped Bike Factor	0.86				0.93		0.68	0.94		0.79		0.60
Frt					0.968			0.988				0.850
Flt Protected	0.950						0.950	0.999		0.950		
Satd. Flow (prot)	1532	1668	0	0	1493	0	1295	2542	0	1453	0	2367
Flt Permitted	0.298						0.950	0.999		0.950		
Satd. Flow (perm)	411	1668	0	0	1493	0	884	2519	0	1148	0	1418
Right Turn on Red			No			No			No			No
Satd. Flow (RTOR)												
Link Speed (mph)		25			25			25			25	
Link Distance (ft)		273			989			826			981	
Travel Time (s)		10.7			57.6			22.5			26.8	
Confl. Peds. (#/hr)	157		172	172		157	111		248	248		111
Peak Hour Factor	0.91	0.91	0.91	0.90	0.90	0.90	0.87	0.87	0.87	0.85	0.85	0.85
Heavy Vehicles (%)	2%	2%	2%	4%	4%	4%	6%	6%	6%	7%	7%	7%
Adj. Flow (vph)	22	134	0	0	184	57	253	763	68	140	0	593
Shared Lane Traffic (%)							10%					
Lane Group Flow (vph)	22	134	0	0	241	0	228	856	0	140	0	593
Turn Type	Perm	NA			NA		Split	NA		Prot		Prot
Protected Phases		4			8		2	2		1		1
Permitted Phases	4									1		1
Detector Phase	4	4			8		2	2		1		1
Switch Phase												
Minimum Initial (s)	10.0	10.0			10.0		7.0	7.0		7.0		7.0
Minimum Split (s)	24.0	24.0			31.0		18.0	18.0		26.0		26.0
Total Split (s)	31.0	31.0			31.0		47.0	47.0		34.0		34.0
Total Split (%)	22.1%	22.1%			22.1%		33.6%	33.6%		24.3%		24.3%
Maximum Green (s)	24.8	24.8			24.8		41.1	41.1		28.4		28.4
Yellow Time (s)	3.2	3.2			3.2		3.1	3.1		3.0		3.0
All-Red Time (s)	3.0	3.0			3.0		2.8	2.8		2.6		2.6
Lost Time Adjust (s)	-1.2	-1.2			-1.2		-0.9	-0.9		-0.6		-0.6
Total Lost Time (s)	5.0	5.0			5.0		5.0	5.0		5.0		5.0
Lead/Lag							Lag	Lag		Lead		Lead
Lead-Lag Optimize?												
Vehicle Extension (s)	2.0	2.0			2.0		4.0	4.0		4.0		4.0
Recall Mode	None	None			None		C-Max	C-Max		None		None
Walk Time (s)	7.0	7.0			7.0		7.0	7.0		7.0		7.0
Flash Dont Walk (s)	10.0	10.0			17.0		5.0	5.0		13.0		13.0
Pedestrian Calls (#/hr)	0	0			0		0	0		0		0
Act Effect Green (s)	25.0	25.0			25.0		47.1	47.1		53.0		53.0

Lane Group	Ø9
Lane Configurations	
Traffic Volume (vph)	
Future Volume (vph)	
Ideal Flow (vphpl)	
Lane Width (ft)	
Grade (%)	
Storage Length (ft)	
Storage Lanes	
Taper Length (ft)	
Lane Util. Factor	
Ped Bike Factor	
Frt	
Flt Protected	
Satd. Flow (prot)	
Flt Permitted	
Satd. Flow (perm)	
Right Turn on Red	
Satd. Flow (RTOR)	
Link Speed (mph)	
Link Distance (ft)	
Travel Time (s)	
Confl. Peds. (#/hr)	
Peak Hour Factor	
Heavy Vehicles (%)	
Adj. Flow (vph)	
Shared Lane Traffic (%)	
Lane Group Flow (vph)	
Turn Type	
Protected Phases	9
Permitted Phases	
Detector Phase	
Switch Phase	
Minimum Initial (s)	7.0
Minimum Split (s)	28.0
Total Split (s)	28.0
Total Split (%)	20%
Maximum Green (s)	24.0
Yellow Time (s)	3.0
All-Red Time (s)	1.0
Lost Time Adjust (s)	
Total Lost Time (s)	
Lead/Lag	
Lead-Lag Optimize?	
Vehicle Extension (s)	0.2
Recall Mode	None
Walk Time (s)	7.0
Flash Dont Walk (s)	17.0
Pedestrian Calls (#/hr)	0
Act Effect Green (s)	

Lanes, Volumes, Timings

2022 Build Alternative 1 PM Peak

16: NC 86 (S. Columbia St) & W. Cameron Avenue/E. Cameron Avenue

Timing Plan: PM Peak

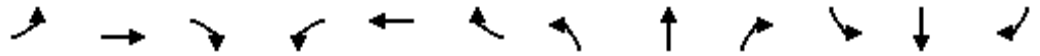

Lane Group	EBL	EBT	EBR	WBL	WBT	WBR	NBL	NBT	NBR	SBL	SBT	SBR
Actuated g/C Ratio	0.18	0.18			0.18		0.34	0.34		0.38		0.38
v/c Ratio	0.30	0.45			0.91		0.52	1.00		0.26		0.66
Control Delay	23.8	20.4			91.7		42.1	77.3		18.1		27.3
Queue Delay	0.0	0.0			0.0		0.0	0.0		0.0		0.0
Total Delay	23.8	20.4			91.7		42.1	77.3		18.1		27.3
LOS	C	C			F		D	E		B		C
Approach Delay		20.9			91.7			69.9				25.5
Approach LOS		C			F			E				C
Queue Length 50th (ft)	11	74			216		178	414		83		259
Queue Length 95th (ft)	m15	m102			#367		265	#542		m105		327
Internal Link Dist (ft)		193			909			746				901
Turn Bay Length (ft)	100									310		
Base Capacity (vph)	76	309			277		435	854		549		895
Starvation Cap Reductn	0	0			0		0	0		0		0
Spillback Cap Reductn	0	0			0		0	0		0		0
Storage Cap Reductn	0	0			0		0	0		0		0
Reduced v/c Ratio	0.29	0.43			0.87		0.52	1.00		0.26		0.66

Intersection Summary

Area Type: CBD
 Cycle Length: 140
 Actuated Cycle Length: 140
 Offset: 23 (16%), Referenced to phase 2:NBTL, Start of Green
 Natural Cycle: 145
 Control Type: Actuated-Coordinated
 Maximum v/c Ratio: 1.00
 Intersection Signal Delay: 54.1 Intersection LOS: D
 Intersection Capacity Utilization 79.5% ICU Level of Service D
 Analysis Period (min) 15
 # 95th percentile volume exceeds capacity, queue may be longer.
 Queue shown is maximum after two cycles.
 m Volume for 95th percentile queue is metered by upstream signal.

Splits and Phases: 16: NC 86 (S. Columbia St) & W. Cameron Avenue/E. Cameron Avenue

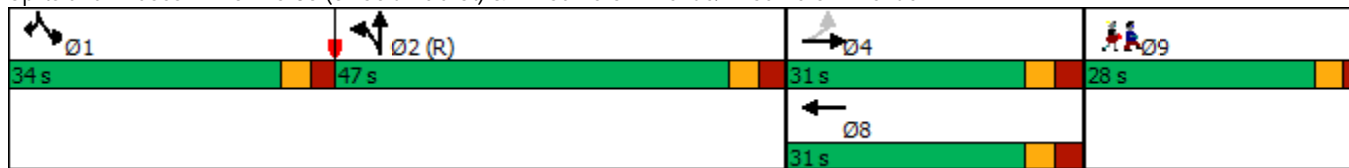

Lane Group	Ø9
Actuated g/C Ratio	
v/c Ratio	
Control Delay	
Queue Delay	
Total Delay	
LOS	
Approach Delay	
Approach LOS	
Queue Length 50th (ft)	
Queue Length 95th (ft)	
Internal Link Dist (ft)	
Turn Bay Length (ft)	
Base Capacity (vph)	
Starvation Cap Reductn	
Spillback Cap Reductn	
Storage Cap Reductn	
Reduced v/c Ratio	
Intersection Summary	

Lanes, Volumes, Timings

2022 Build Alternative 1 PM Peak

17: Raleigh Street & E. Cameron Avenue/Country Club Road

Timing Plan: PM Peak

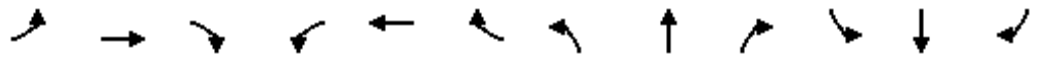

Lane Group	EBL	EBT	EBR	WBL	WBT	WBR	NBL	NBT	NBR	SBL	SBT	SBR
Lane Configurations		↕		↖	↗		↖	↗		↖	↗	
Traffic Volume (vph)	27	162	47	35	129	179	55	92	61	262	186	53
Future Volume (vph)	27	162	47	35	129	179	55	92	61	262	186	53
Ideal Flow (vphpl)	1900	1900	1900	1900	1900	1900	1900	1900	1900	1900	1900	1900
Grade (%)		-3%			3%			-2%				1%
Storage Length (ft)	0		0	150		0	125		0	75		0
Storage Lanes	0		0	1		0	1		0	1		0
Taper Length (ft)	25			25			25			25		
Lane Util. Factor	1.00	1.00	1.00	1.00	1.00	1.00	1.00	1.00	1.00	1.00	1.00	1.00
Ped Bike Factor		0.94			0.88			0.88		0.82	0.88	
Frt		0.973			0.913			0.940			0.967	
Flt Protected		0.994		0.950			0.950			0.950		
Satd. Flow (prot)	0	1571	0	1569	1329	0	1563	1358	0	1585	1419	0
Flt Permitted		0.924		0.374			0.586			0.450		
Satd. Flow (perm)	0	1441	0	618	1329	0	964	1358	0	613	1419	0
Right Turn on Red			No			No			No			No
Satd. Flow (RTOR)												
Link Speed (mph)		25			25			25				25
Link Distance (ft)		598			651			409				995
Travel Time (s)		16.3			17.8			11.2				27.1
Confl. Peds. (#/hr)	39		37	37		39	107		60	60		107
Peak Hour Factor	0.75	0.75	0.75	0.89	0.89	0.89	0.89	0.89	0.89	0.84	0.84	0.84
Heavy Vehicles (%)	2%	2%	2%	2%	2%	2%	5%	5%	5%	2%	2%	2%
Adj. Flow (vph)	36	216	63	39	145	201	62	103	69	312	221	63
Shared Lane Traffic (%)												
Lane Group Flow (vph)	0	315	0	39	346	0	62	172	0	312	284	0
Turn Type	Perm	NA		pm+pt	NA		pm+pt	NA		pm+pt	NA	
Protected Phases		2		1	6		3	8		7	4	
Permitted Phases	2			6			8			4		
Detector Phase	2	2		1	6		3	8		7	4	
Switch Phase												
Minimum Initial (s)	10.0	10.0		7.0	10.0		7.0	7.0		7.0	7.0	
Minimum Split (s)	18.0	18.0		13.0	19.0		13.0	19.0		12.0	16.0	
Total Split (s)	50.0	50.0		20.0	70.0		20.0	35.0		20.0	35.0	
Total Split (%)	40.0%	40.0%		16.0%	56.0%		16.0%	28.0%		16.0%	28.0%	
Maximum Green (s)	43.9	43.9		14.4	64.4		14.7	29.7		15.1	29.9	
Yellow Time (s)	3.3	3.3		3.0	3.1		3.0	3.1		3.0	3.1	
All-Red Time (s)	2.8	2.8		2.6	2.5		2.3	2.2		1.9	2.0	
Lost Time Adjust (s)		-1.1		-0.6	-0.6		-0.3	-0.3		0.1	-0.1	
Total Lost Time (s)		5.0		5.0	5.0		5.0	5.0		5.0	5.0	
Lead/Lag	Lag	Lag		Lead			Lead	Lag		Lead	Lag	
Lead-Lag Optimize?	Yes	Yes		Yes			Yes	Yes		Yes	Yes	
Vehicle Extension (s)	2.0	2.0		2.0	2.0		2.0	2.0		2.0	2.0	
Recall Mode	None	None		None	None		None	None		None	None	
Walk Time (s)	4.0	4.0			4.0			4.0			4.0	
Flash Dont Walk (s)	7.0	7.0			9.0			9.0			6.0	
Pedestrian Calls (#/hr)	0	0			0			0			0	
Act Effect Green (s)		24.4		30.8	30.8		23.9	15.6		36.5	26.7	
Actuated g/C Ratio		0.31		0.39	0.39		0.31	0.20		0.47	0.34	

Lanes, Volumes, Timings
 17: Raleigh Street & E. Cameron Avenue/Country Club Road

2022 Build Alternative 1 PM Peak
 Timing Plan: PM Peak



Lane Group	EBL	EBT	EBR	WBL	WBT	WBR	NBL	NBT	NBR	SBL	SBT	SBR
v/c Ratio		0.70		0.11	0.66		0.17	0.64		0.65	0.59	
Control Delay		35.1		15.1	25.8		17.6	43.4		25.6	32.9	
Queue Delay		0.0		0.0	0.0		0.0	0.0		0.0	0.0	
Total Delay		35.1		15.1	25.8		17.6	43.4		25.6	32.9	
LOS		D		B	C		B	D		C	C	
Approach Delay		35.1			24.7			36.5			29.1	
Approach LOS		D			C			D			C	
Queue Length 50th (ft)		146		11	128		19	84		111	132	
Queue Length 95th (ft)		213		32	248		51	172		#213	248	
Internal Link Dist (ft)		518			571			329			915	
Turn Bay Length (ft)				150			125			75		
Base Capacity (vph)		904		448	1088		518	568		489	596	
Starvation Cap Reductn		0		0	0		0	0		0	0	
Spillback Cap Reductn		0		0	0		0	0		0	0	
Storage Cap Reductn		0		0	0		0	0		0	0	
Reduced v/c Ratio		0.35		0.09	0.32		0.12	0.30		0.64	0.48	

Intersection Summary

Area Type: CBD
 Cycle Length: 125
 Actuated Cycle Length: 78.2
 Natural Cycle: 70
 Control Type: Actuated-Uncoordinated
 Maximum v/c Ratio: 0.70
 Intersection Signal Delay: 30.4
 Intersection LOS: C
 Intersection Capacity Utilization 79.1%
 ICU Level of Service D
 Analysis Period (min) 15
 # 95th percentile volume exceeds capacity, queue may be longer.
 Queue shown is maximum after two cycles.

Splits and Phases: 17: Raleigh Street & E. Cameron Avenue/Country Club Road

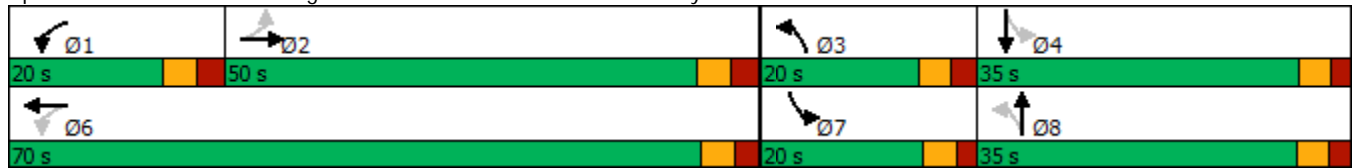



2022 With Parking Deck – North Street Site Access

Lanes, Volumes, Timings
1: Church Street & W. Rosemary Street

09/01/2020



Lane Group	EBL	EBT	EBR	WBL	WBT	WBR	NBL	NBT	NBR	SBL	SBT	SBR
Lane Configurations		↕			↕			↕			↕	
Traffic Volume (vph)	14	289	21	32	301	15	33	24	40	27	39	11
Future Volume (vph)	14	289	21	32	301	15	33	24	40	27	39	11
Ideal Flow (vphpl)	1900	1900	1900	1900	1900	1900	1900	1900	1900	1900	1900	1900
Lane Width (ft)	12	14	12	12	14	12	12	12	12	12	12	12
Grade (%)		1%			-1%			0%			0%	
Lane Util. Factor	1.00	1.00	1.00	1.00	1.00	1.00	1.00	1.00	1.00	1.00	1.00	1.00
Ped Bike Factor		0.99			0.99			0.95			0.97	
Frt		0.991			0.994			0.944			0.981	
Flt Protected		0.998			0.995			0.983			0.983	
Satd. Flow (prot)	0	1734	0	0	1737	0	0	1501	0	0	1602	0
Flt Permitted		0.982			0.950			0.884			0.873	
Satd. Flow (perm)	0	1704	0	0	1655	0	0	1332	0	0	1395	0
Right Turn on Red			No			No			No			No
Satd. Flow (RTOR)												
Link Speed (mph)		20			20			25			25	
Link Distance (ft)		964			757			379			430	
Travel Time (s)		32.9			25.8			10.3			11.7	
Confl. Peds. (#/hr)	20		17	17		20	21		31	31		21
Peak Hour Factor	0.86	0.86	0.86	0.89	0.89	0.89	0.84	0.84	0.84	0.72	0.72	0.72
Heavy Vehicles (%)	3%	3%	3%	4%	4%	4%	2%	2%	2%	2%	2%	2%
Adj. Flow (vph)	16	336	24	36	338	17	39	29	48	38	54	15
Shared Lane Traffic (%)												
Lane Group Flow (vph)	0	376	0	0	391	0	0	116	0	0	107	0
Turn Type	Perm	NA		Perm	NA		Perm	NA		Perm	NA	
Protected Phases		2			6			8			4	
Permitted Phases	2			6			8			4		
Detector Phase	2	2		6	6		8	8		4	4	
Switch Phase												
Minimum Initial (s)	10.0	10.0		10.0	10.0		7.0	7.0		7.0	7.0	
Minimum Split (s)	19.0	19.0		20.0	20.0		19.0	19.0		19.0	19.0	
Total Split (s)	38.0	38.0		38.0	38.0		22.0	22.0		22.0	22.0	
Total Split (%)	63.3%	63.3%		63.3%	63.3%		36.7%	36.7%		36.7%	36.7%	
Maximum Green (s)	33.5	33.5		33.4	33.4		17.1	17.1		17.1	17.1	
Yellow Time (s)	3.1	3.1		3.1	3.1		3.2	3.2		3.2	3.2	
All-Red Time (s)	1.4	1.4		1.5	1.5		1.7	1.7		1.7	1.7	
Lost Time Adjust (s)		0.5			0.4			0.1			0.1	
Total Lost Time (s)		5.0			5.0			5.0			5.0	
Lead/Lag												
Lead-Lag Optimize?												
Vehicle Extension (s)	3.0	3.0		3.0	3.0		3.0	3.0		3.0	3.0	
Recall Mode	C-Max	C-Max		C-Max	C-Max		None	None		None	None	
Walk Time (s)	4.0	4.0		4.0	4.0		4.0	4.0		4.0	4.0	
Flash Dont Walk (s)	5.0	5.0		6.0	6.0		10.0	10.0		10.0	10.0	
Pedestrian Calls (#/hr)	0	0		0	0		0	0		0	0	
Act Effct Green (s)		42.8			42.8			10.6			10.6	
Actuated g/C Ratio		0.71			0.71			0.18			0.18	
v/c Ratio		0.31			0.33			0.49			0.43	
Control Delay		5.8			3.9			24.8			26.6	

Lanes, Volumes, Timings
 1: Church Street & W. Rosemary Street

09/01/2020



Lane Group	EBL	EBT	EBR	WBL	WBT	WBR	NBL	NBT	NBR	SBL	SBT	SBR
Queue Delay		0.0			0.0			0.0			0.0	
Total Delay		5.8			3.9			24.8			26.6	
LOS		A			A			C			C	
Approach Delay		5.8			3.9			24.8			26.6	
Approach LOS		A			A			C			C	
Queue Length 50th (ft)		48			17			38			35	
Queue Length 95th (ft)		103			96			54			53	
Internal Link Dist (ft)		884			677			299			350	
Turn Bay Length (ft)												
Base Capacity (vph)		1214			1179			377			395	
Starvation Cap Reductn		0			0			0			0	
Spillback Cap Reductn		0			0			0			0	
Storage Cap Reductn		0			0			0			0	
Reduced v/c Ratio		0.31			0.33			0.31			0.27	

Intersection Summary

Area Type:	CBD
Cycle Length:	60
Actuated Cycle Length:	60
Offset:	7 (12%), Referenced to phase 2:EBTL and 6:WBTL, Start of Green
Natural Cycle:	40
Control Type:	Actuated-Coordinated
Maximum v/c Ratio:	0.49
Intersection Signal Delay:	9.5
Intersection LOS:	A
Intersection Capacity Utilization:	51.4%
ICU Level of Service:	A
Analysis Period (min):	15

Splits and Phases: 1: Church Street & W. Rosemary Street



Lanes, Volumes, Timings

2: NC 86 (N. Columbia St) & W. Rosemary Street/E. Rosemary Street

09/01/2020



Lane Group	EBL	EBT	EBR	WBL	WBT	WBR	NBL	NBT	NBR	SBL	SBT	SBR
Lane Configurations												
Traffic Volume (vph)	150	210	21	16	167	28	22	309	80	48	559	176
Future Volume (vph)	150	210	21	16	167	28	22	309	80	48	559	176
Ideal Flow (vphpl)	1900	1900	1900	1900	1900	1900	1900	1900	1900	1900	1900	1900
Lane Width (ft)	9	12	13	12	12	12	9	10	12	12	9	11
Grade (%)		1%			1%			-2%			8%	
Storage Length (ft)	100		0	150		0	75		0	150		400
Storage Lanes	1		0	1		0	1		0	1		1
Taper Length (ft)	25			25			25			25		
Lane Util. Factor	1.00	1.00	1.00	1.00	1.00	1.00	1.00	0.95	0.95	1.00	0.95	1.00
Ped Bike Factor	0.99	1.00		0.98	1.00		0.98	0.97		0.95		0.91
Frt		0.987			0.979			0.969				0.850
Flt Protected	0.950			0.950			0.950			0.950		
Satd. Flow (prot)	1426	1641	0	1585	1626	0	1355	2646	0	1485	2673	1285
Flt Permitted	0.287			0.594			0.353			0.458		
Satd. Flow (perm)	427	1641	0	975	1626	0	494	2646	0	677	2673	1169
Right Turn on Red			No			No			No			No
Satd. Flow (RTOR)												
Link Speed (mph)		20			20			25			25	
Link Distance (ft)		757			461			353			476	
Travel Time (s)		25.8			15.7			9.6			13.0	
Confl. Peds. (#/hr)	12		16	16		12	19		34	34		19
Peak Hour Factor	0.86	0.86	0.86	0.90	0.90	0.90	0.90	0.90	0.90	0.88	0.88	0.88
Heavy Vehicles (%)	2%	2%	2%	2%	2%	2%	9%	9%	9%	5%	5%	5%
Adj. Flow (vph)	174	244	24	18	186	31	24	343	89	55	635	200
Shared Lane Traffic (%)												
Lane Group Flow (vph)	174	268	0	18	217	0	24	432	0	55	635	200
Turn Type	pm+pt	NA		Perm	NA		pm+pt	NA		pm+pt	NA	pm+ov
Protected Phases	7	4			8		5	2		1	6	7
Permitted Phases	4			8			2			6		6
Detector Phase	7	4		8	8		5	2		1	6	7
Switch Phase												
Minimum Initial (s)	7.0	7.0		7.0	7.0		7.0	10.0		7.0	10.0	7.0
Minimum Split (s)	13.0	31.0		32.0	32.0		13.0	23.0		13.0	22.0	13.0
Total Split (s)	23.0	57.0		34.0	34.0		13.0	50.0		13.0	50.0	23.0
Total Split (%)	19.2%	47.5%		28.3%	28.3%		10.8%	41.7%		10.8%	41.7%	19.2%
Maximum Green (s)	17.2	51.0		28.0	28.0		7.2	44.2		7.9	44.2	17.2
Yellow Time (s)	3.0	3.2		3.2	3.2		3.0	3.3		3.0	3.3	3.0
All-Red Time (s)	2.8	2.8		2.8	2.8		2.8	2.5		2.1	2.5	2.8
Lost Time Adjust (s)	-0.8	-1.0		-1.0	-1.0		-1.0	-0.8		-0.1	-0.8	-0.8
Total Lost Time (s)	5.0	5.0		5.0	5.0		4.8	5.0		5.0	5.0	5.0
Lead/Lag	Lead			Lag	Lag		Lead	Lag		Lead	Lag	Lead
Lead-Lag Optimize?												
Vehicle Extension (s)	1.0	1.0		1.0	1.0		1.0	3.0		1.0	3.0	1.0
Recall Mode	None	None		None	None		None	C-Max		None	C-Max	None
Walk Time (s)		7.0		7.0	7.0			7.0			7.0	
Flash Dont Walk (s)		18.0		19.0	19.0			10.0			9.0	
Pedestrian Calls (#/hr)		0		0	0			0			0	
Act Effect Green (s)	41.4	41.4		20.5	20.5		65.3	58.7		65.5	61.0	76.9

Lanes, Volumes, Timings

2: NC 86 (N. Columbia St) & W. Rosemary Street/E. Rosemary Street

09/01/2020



Lane Group	EBL	EBT	EBR	WBL	WBT	WBR	NBL	NBT	NBR	SBL	SBT	SBR
Actuated g/C Ratio	0.34	0.34		0.17	0.17		0.54	0.49		0.55	0.51	0.64
v/c Ratio	0.62	0.47		0.11	0.78		0.07	0.33		0.13	0.47	0.26
Control Delay	38.9	33.8		35.7	57.9		12.1	14.7		13.5	17.9	7.3
Queue Delay	0.0	0.0		0.0	0.0		0.0	0.1		0.0	0.0	0.0
Total Delay	38.9	33.8		35.7	57.9		12.1	14.8		13.5	17.9	7.3
LOS	D	C		D	E		B	B		B	B	A
Approach Delay		35.8			56.2			14.7			15.3	
Approach LOS		D			E			B			B	
Queue Length 50th (ft)	105	167		10	134		5	60		17	107	35
Queue Length 95th (ft)	140	227		29	197		m14	105		35	150	50
Internal Link Dist (ft)		677			381			273			396	
Turn Bay Length (ft)	100			150			75			150		400
Base Capacity (vph)	296	711		235	392		328	1294		425	1358	786
Starvation Cap Reductn	0	0		0	0		0	185		0	0	0
Spillback Cap Reductn	0	0		0	0		0	0		0	0	0
Storage Cap Reductn	0	0		0	0		0	0		0	0	0
Reduced v/c Ratio	0.59	0.38		0.08	0.55		0.07	0.39		0.13	0.47	0.25

Intersection Summary

Area Type:	CBD
Cycle Length:	120
Actuated Cycle Length:	120
Offset:	41 (34%), Referenced to phase 2:NBTL and 6:SBTL, Start of Green
Natural Cycle:	85
Control Type:	Actuated-Coordinated
Maximum v/c Ratio:	0.78
Intersection Signal Delay:	24.4
Intersection LOS:	C
Intersection Capacity Utilization:	63.8%
ICU Level of Service:	B
Analysis Period (min):	15
m Volume for 95th percentile queue is metered by upstream signal.	

Splits and Phases: 2: NC 86 (N. Columbia St) & W. Rosemary Street/E. Rosemary Street

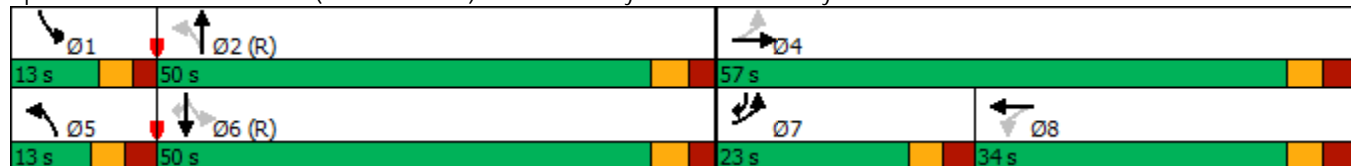

Lanes, Volumes, Timings
6: Henderson Street & E. Rosemary Street

09/01/2020



Lane Group	EBL	EBT	EBR	WBL	WBT	WBR	NBL	NBT	NBR	SBL	SBT	SBR
Lane Configurations												
Traffic Volume (vph)	5	138	60	8	238	16	58	6	8	9	17	5
Future Volume (vph)	5	138	60	8	238	16	58	6	8	9	17	5
Ideal Flow (vphpl)	1900	1900	1900	1900	1900	1900	1900	1900	1900	1900	1900	1900
Grade (%)		0%			0%			0%				3%
Storage Length (ft)	85		0	0		0	0		0	0		0
Storage Lanes	1		0	0		0	0		0	0		0
Taper Length (ft)	25			25			25			25		
Lane Util. Factor	1.00	1.00	1.00	1.00	1.00	1.00	1.00	1.00	1.00	1.00	1.00	1.00
Ped Bike Factor	0.99	0.99			1.00			0.95				0.98
Frt		0.955			0.992			0.985				0.979
Flt Protected	0.950				0.998			0.961				0.986
Satd. Flow (prot)	1593	1584	0	0	1657	0	0	1559	0	0	1561	0
Flt Permitted	0.596				0.992			0.737				0.886
Satd. Flow (perm)	993	1584	0	0	1646	0	0	1150	0	0	1384	0
Right Turn on Red			No			No			No			No
Satd. Flow (RTOR)												
Link Speed (mph)		20			20			20				20
Link Distance (ft)		496			1195			366				450
Travel Time (s)		16.9			40.7			12.5				15.3
Confl. Peds. (#/hr)	4		6	6		4	22		23	23		22
Peak Hour Factor	0.89	0.89	0.89	0.75	0.75	0.75	0.87	0.87	0.87	0.68	0.68	0.68
Heavy Vehicles (%)	2%	2%	2%	2%	2%	2%	3%	3%	3%	3%	3%	3%
Adj. Flow (vph)	6	155	67	11	317	21	67	7	9	13	25	7
Shared Lane Traffic (%)												
Lane Group Flow (vph)	6	222	0	0	349	0	0	83	0	0	45	0
Turn Type	Perm	NA		Perm	NA		Perm	NA		Perm	NA	
Protected Phases		2			2			4				4
Permitted Phases	2			2			4			4		
Detector Phase	2	2		2	2		4	4		4	4	
Switch Phase												
Minimum Initial (s)	11.0	11.0		11.0	11.0		8.0	8.0		8.0	8.0	
Minimum Split (s)	15.9	15.9		15.9	15.9		17.8	17.8		17.8	17.8	
Total Split (s)	40.0	40.0		40.0	40.0		20.0	20.0		20.0	20.0	
Total Split (%)	66.7%	66.7%		66.7%	66.7%		33.3%	33.3%		33.3%	33.3%	
Maximum Green (s)	35.1	35.1		35.1	35.1		15.2	15.2		15.2	15.2	
Yellow Time (s)	3.3	3.3		3.3	3.3		3.3	3.3		3.3	3.3	
All-Red Time (s)	1.6	1.6		1.6	1.6		1.5	1.5		1.5	1.5	
Lost Time Adjust (s)	0.1	0.1			0.1			0.2				0.2
Total Lost Time (s)	5.0	5.0			5.0			5.0				5.0
Lead/Lag												
Lead-Lag Optimize?												
Vehicle Extension (s)	2.0	2.0		2.0	2.0		2.0	2.0		2.0	2.0	
Recall Mode	C-Max	C-Max		C-Max	C-Max		None	None		None	None	
Walk Time (s)	4.0	4.0		4.0	4.0		4.0	4.0		4.0	4.0	
Flash Dont Walk (s)	7.0	7.0		7.0	7.0		9.0	9.0		9.0	9.0	
Pedestrian Calls (#/hr)	0	0		0	0		0	0		0	0	
Act Effect Green (s)	44.2	44.2			44.2			9.4				9.4
Actuated g/C Ratio	0.74	0.74			0.74			0.16				0.16

Lanes, Volumes, Timings
 6: Henderson Street & E. Rosemary Street

09/01/2020



Lane Group	EBL	EBT	EBR	WBL	WBT	WBR	NBL	NBT	NBR	SBL	SBT	SBR
v/c Ratio	0.01	0.19			0.29			0.46				0.21
Control Delay	6.0	5.5			5.5			27.8				23.5
Queue Delay	0.0	0.0			0.0			0.0				0.0
Total Delay	6.0	5.5			5.5			27.8				23.5
LOS	A	A			A			C				C
Approach Delay		5.5			5.5			27.8				23.5
Approach LOS		A			A			C				C
Queue Length 50th (ft)	1	44			70			41				15
Queue Length 95th (ft)	m5	92			83			76				27
Internal Link Dist (ft)		416			1115			286				370
Turn Bay Length (ft)	85											
Base Capacity (vph)	730	1166			1211			287				346
Starvation Cap Reductn	0	0			0			0				0
Spillback Cap Reductn	0	0			0			0				0
Storage Cap Reductn	0	0			0			0				0
Reduced v/c Ratio	0.01	0.19			0.29			0.29				0.13

Intersection Summary

Area Type: CBD
 Cycle Length: 60
 Actuated Cycle Length: 60
 Offset: 38 (63%), Referenced to phase 2:EBWB, Start of Green
 Natural Cycle: 40
 Control Type: Actuated-Coordinated
 Maximum v/c Ratio: 0.46
 Intersection Signal Delay: 9.3
 Intersection Capacity Utilization 41.4%
 Analysis Period (min) 15
 Intersection LOS: A
 ICU Level of Service A

m Volume for 95th percentile queue is metered by upstream signal.

Splits and Phases: 6: Henderson Street & E. Rosemary Street



Lanes, Volumes, Timings

7: Hillsborough Street & E. Rosemary Street

09/01/2020



Lane Group	EBL	EBT	EBR	WBL	WBT	WBR	NBL	NBT	NBR	SBL	SBT	SBR
Lane Configurations		↕			↕		↗	↘		↗	↘	
Traffic Volume (vph)	6	57	68	0	110	12	135	142	6	21	356	32
Future Volume (vph)	6	57	68	0	110	12	135	142	6	21	356	32
Ideal Flow (vphpl)	1900	1900	1900	1900	1900	1900	1900	1900	1900	1900	1900	1900
Storage Length (ft)	0		0	0		0	100		0	100		0
Storage Lanes	0		0	0		0	1		0	1		0
Taper Length (ft)	25			25			25			25		
Lane Util. Factor	1.00	1.00	1.00	1.00	1.00	1.00	1.00	1.00	1.00	1.00	1.00	1.00
Ped Bike Factor		0.99			1.00			1.00		1.00	1.00	
Frt		0.930			0.987			0.994			0.987	
Flt Protected		0.998					0.950			0.950		
Satd. Flow (prot)	0	1706	0	0	1832	0	1752	1832	0	1752	1812	0
Flt Permitted		0.979					0.378			0.656		
Satd. Flow (perm)	0	1672	0	0	1832	0	697	1832	0	1204	1812	0
Right Turn on Red			No			No			No			No
Satd. Flow (RTOR)												
Link Speed (mph)		20			20			25			25	
Link Distance (ft)		1195			527			363			726	
Travel Time (s)		40.7			18.0			9.9			19.8	
Confl. Peds. (#/hr)	6		3	3		6	13		2	2		13
Peak Hour Factor	0.82	0.82	0.82	0.71	0.71	0.71	0.93	0.93	0.93	0.90	0.90	0.90
Heavy Vehicles (%)	2%	2%	2%	2%	2%	2%	3%	3%	3%	3%	3%	3%
Adj. Flow (vph)	7	70	83	0	155	17	145	153	6	23	396	36
Shared Lane Traffic (%)												
Lane Group Flow (vph)	0	160	0	0	172	0	145	159	0	23	432	0
Turn Type	Perm	NA			NA		pm+pt	NA		Perm	NA	
Protected Phases		4			8		5	2			6	
Permitted Phases	4			8			2			6		
Detector Phase	4	4		8	8		5	2		6	6	
Switch Phase												
Minimum Initial (s)	7.0	7.0		7.0	7.0		7.0	10.0		10.0	10.0	
Minimum Split (s)	20.0	20.0		17.0	17.0		12.0	15.0		15.0	15.0	
Total Split (s)	20.0	20.0		20.0	20.0		12.0	40.0		28.0	28.0	
Total Split (%)	33.3%	33.3%		33.3%	33.3%		20.0%	66.7%		46.7%	46.7%	
Maximum Green (s)	15.1	15.1		15.0	15.0		7.2	35.2		23.2	23.2	
Yellow Time (s)	3.0	3.0		3.3	3.3		3.0	3.3		3.1	3.1	
All-Red Time (s)	1.9	1.9		1.7	1.7		1.8	1.5		1.7	1.7	
Lost Time Adjust (s)		0.1			0.0		0.2	0.2		0.2	0.2	
Total Lost Time (s)		5.0			5.0		5.0	5.0		5.0	5.0	
Lead/Lag							Lead			Lag	Lag	
Lead-Lag Optimize?							Yes			Yes	Yes	
Vehicle Extension (s)	2.0	2.0		2.0	2.0		2.0	2.0		2.0	2.0	
Recall Mode	None	None		None	None		None	C-Max		C-Max	C-Max	
Walk Time (s)	4.0	4.0		4.0	4.0			4.0		4.0	4.0	
Flash Dont Walk (s)	11.0	11.0		8.0	8.0			6.0		6.0	6.0	
Pedestrian Calls (#/hr)	0	0		0	0			0		0	0	
Act Effct Green (s)		10.2			10.2		42.2	43.2		33.5	33.5	
Actuated g/C Ratio		0.17			0.17		0.70	0.72		0.56	0.56	
v/c Ratio		0.56			0.55		0.24	0.12		0.03	0.43	

Lanes, Volumes, Timings
 7: Hillsborough Street & E. Rosemary Street

09/01/2020



Lane Group	EBL	EBT	EBR	WBL	WBT	WBR	NBL	NBT	NBR	SBL	SBT	SBR
Control Delay		28.9			29.0		3.1	2.4		10.8	13.4	
Queue Delay		0.0			0.0		0.0	0.0		0.0	0.0	
Total Delay		28.9			29.0		3.1	2.4		10.8	13.4	
LOS		C			C		A	A		B	B	
Approach Delay		28.9			29.0			2.7				13.3
Approach LOS		C			C			A				B
Queue Length 50th (ft)		60			58		7	8		4	102	
Queue Length 95th (ft)		91			77		20	22		17	207	
Internal Link Dist (ft)		1115			447			283				646
Turn Bay Length (ft)							100			100		
Base Capacity (vph)		418			458		615	1318		671	1011	
Starvation Cap Reductn		0			0		0	0		0	0	
Spillback Cap Reductn		0			0		0	0		0	0	
Storage Cap Reductn		0			0		0	0		0	0	
Reduced v/c Ratio		0.38			0.38		0.24	0.12		0.03	0.43	

Intersection Summary

Area Type:	Other
Cycle Length:	60
Actuated Cycle Length:	60
Offset:	14 (23%), Referenced to phase 2:NBTL and 6:SBTL, Start of Green
Natural Cycle:	55
Control Type:	Actuated-Coordinated
Maximum v/c Ratio:	0.56
Intersection Signal Delay:	15.1
Intersection LOS:	B
Intersection Capacity Utilization	53.4%
ICU Level of Service	A
Analysis Period (min)	15

Splits and Phases: 7: Hillsborough Street & E. Rosemary Street



Lanes, Volumes, Timings

8: Carolina Square Driveway/Church Street & W. Franklin Street

09/01/2020



Lane Group	EBL	EBT	EBR	WBL	WBT	WBR	NBL	NBT	NBR	SBL	SBT	SBR
Lane Configurations												
Traffic Volume (vph)	49	336	23	10	248	43	2	5	10	20	20	49
Future Volume (vph)	49	336	23	10	248	43	2	5	10	20	20	49
Ideal Flow (vphpl)	1900	1900	1900	1900	1900	1900	1900	1900	1900	1900	1900	1900
Lane Width (ft)	10	10	16	10	10	10	12	12	12	12	12	12
Grade (%)		2%			-2%			-4%				-3%
Storage Length (ft)	150		0	200		0	0		100	0		0
Storage Lanes	1		0	1		0	0		1	0		0
Taper Length (ft)	25			25			25			25		
Lane Util. Factor	1.00	1.00	1.00	1.00	1.00	1.00	1.00	1.00	1.00	1.00	1.00	1.00
Ped Bike Factor	0.95	0.99		0.95	0.98			0.98	0.94		0.94	
Frt		0.991			0.978				0.850		0.926	
Flt Protected	0.950			0.950				0.985			0.989	
Satd. Flow (prot)	1430	1479	0	1431	1450	0	0	1621	1399	0	1431	0
Flt Permitted	0.551			0.503				0.884			0.918	
Satd. Flow (perm)	789	1479	0	721	1450	0	0	1423	1316	0	1317	0
Right Turn on Red			No			No			No			No
Satd. Flow (RTOR)												
Link Speed (mph)		20			20			20			25	
Link Distance (ft)		993			298			285			379	
Travel Time (s)		33.9			10.2			9.7			10.3	
Confl. Peds. (#/hr)	39		57	57		39	57		29	29		57
Peak Hour Factor	0.84	0.84	0.84	0.83	0.83	0.83	0.53	0.53	0.53	0.92	0.92	0.92
Heavy Vehicles (%)	5%	5%	5%	7%	7%	7%	6%	6%	6%	5%	5%	5%
Adj. Flow (vph)	58	400	27	12	299	52	4	9	19	22	22	53
Shared Lane Traffic (%)												
Lane Group Flow (vph)	58	427	0	12	351	0	0	13	19	0	97	0
Turn Type	Perm	NA		Perm	NA		Perm	NA	Perm	Perm	NA	
Protected Phases		2			6			8				4
Permitted Phases	2			6			8		8	4		
Detector Phase	2	2		6	6		8	8	8	4	4	
Switch Phase												
Minimum Initial (s)	10.0	10.0		10.0	10.0		7.0	7.0	7.0	7.0	7.0	
Minimum Split (s)	22.0	22.0		19.0	19.0		29.0	29.0	29.0	27.0	27.0	
Total Split (s)	31.0	31.0		31.0	31.0		29.0	29.0	29.0	29.0	29.0	
Total Split (%)	51.7%	51.7%		51.7%	51.7%		48.3%	48.3%	48.3%	48.3%	48.3%	
Maximum Green (s)	25.4	25.4		25.4	25.4		22.7	22.7	22.7	23.0	23.0	
Yellow Time (s)	3.3	3.3		3.3	3.3		3.1	3.1	3.1	3.4	3.4	
All-Red Time (s)	2.3	2.3		2.3	2.3		3.2	3.2	3.2	2.6	2.6	
Lost Time Adjust (s)	-0.6	-0.6		-0.6	-0.6		-1.3	-1.3	-1.3	-1.0	-1.0	
Total Lost Time (s)	5.0	5.0		5.0	5.0		5.0	5.0	5.0	5.0	5.0	
Lead/Lag												
Lead-Lag Optimize?												
Vehicle Extension (s)	3.0	3.0		3.0	3.0		2.0	2.0	2.0	2.0	2.0	
Recall Mode	C-Max	C-Max		C-Max	C-Max		None	None	None	None	None	
Walk Time (s)	7.0	7.0		7.0	7.0		7.0	7.0	7.0	7.0	7.0	
Flash Dont Walk (s)	9.0	9.0		6.0	6.0		15.0	15.0	15.0	14.0	14.0	
Pedestrian Calls (#/hr)	0	0		0	0		0	0	0	0	0	
Act Effect Green (s)	43.3	43.3		43.3	43.3		10.3	10.3	10.3	10.3	10.3	

Lanes, Volumes, Timings

8: Carolina Square Driveway/Church Street & W. Franklin Street

09/01/2020



Lane Group	EBL	EBT	EBR	WBL	WBT	WBR	NBL	NBT	NBR	SBL	SBT	SBR
Actuated g/C Ratio	0.72	0.72		0.72	0.72			0.17	0.17			0.17
v/c Ratio	0.10	0.40		0.02	0.34			0.05	0.08			0.43
Control Delay	5.0	6.5		2.1	4.0			19.7	20.2			24.9
Queue Delay	0.0	0.0		0.0	0.0			0.0	0.0			0.0
Total Delay	5.0	6.5		2.1	4.0			19.7	20.2			24.9
LOS	A	A		A	A			B	C			C
Approach Delay		6.3			4.0			20.0				24.9
Approach LOS		A			A			C				C
Queue Length 50th (ft)	6	57		3	80			4	6			35
Queue Length 95th (ft)	20	119		m1	28			9	12			56
Internal Link Dist (ft)		913			218			205				299
Turn Bay Length (ft)	150			200					100			
Base Capacity (vph)	569	1067		520	1046			569	526			526
Starvation Cap Reductn	0	0		0	0			0	0			0
Spillback Cap Reductn	0	0		0	0			0	0			0
Storage Cap Reductn	0	0		0	0			0	0			0
Reduced v/c Ratio	0.10	0.40		0.02	0.34			0.02	0.04			0.18

Intersection Summary

Area Type: CBD
 Cycle Length: 60
 Actuated Cycle Length: 60
 Offset: 42 (70%), Referenced to phase 2:EBTL and 6:WBTL, Start of Green
 Natural Cycle: 60
 Control Type: Actuated-Coordinated
 Maximum v/c Ratio: 0.43
 Intersection Signal Delay: 7.7 Intersection LOS: A
 Intersection Capacity Utilization 63.7% ICU Level of Service B
 Analysis Period (min) 15
 m Volume for 95th percentile queue is metered by upstream signal.

Splits and Phases: 8: Carolina Square Driveway/Church Street & W. Franklin Street

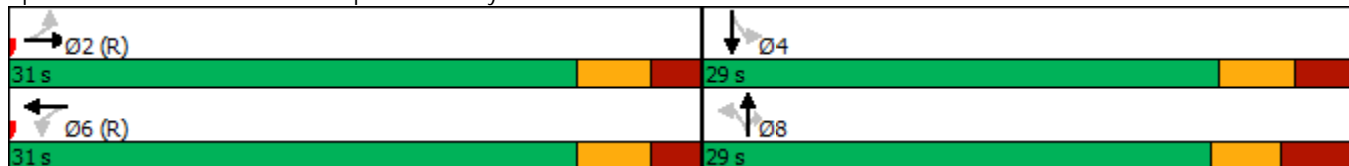

Lanes, Volumes, Timings

9: NC 86 (S. Columbia St)/NC 86 (N. Columbia St) & W. Franklin Street/E. Franklin Street 09/01/2020



Lane Group	EBL	EBT	EBR	WBL	WBT	WBR	NBL	NBT	NBR	SBL	SBT	SBR
Lane Configurations												
Traffic Volume (vph)	70	283	29	65	275	46	30	317	87	36	460	79
Future Volume (vph)	70	283	29	65	275	46	30	317	87	36	460	79
Ideal Flow (vphpl)	1900	1900	1900	1900	1900	1900	1900	1900	1900	1900	1900	1900
Lane Width (ft)	9	12	13	10	10	13	9	10	10	9	9	11
Grade (%)		3%			1%			-2%			3%	
Storage Length (ft)	250		0	125		0	475		0	125		0
Storage Lanes	1		0	1		1	1		0	1		0
Taper Length (ft)	25			25			25			25		
Lane Util. Factor	1.00	0.95	0.95	1.00	1.00	1.00	1.00	0.95	0.95	1.00	0.95	0.95
Ped Bike Factor	0.87	0.99		0.95		0.79	0.97	0.96		0.91	0.99	
Frt		0.986				0.850		0.968			0.978	
Flt Protected	0.950			0.950			0.950			0.950		
Satd. Flow (prot)	1372	2980	0	1410	1484	1397	1342	2597	0	1346	2595	0
Flt Permitted	0.950			0.950			0.950			0.950		
Satd. Flow (perm)	1191	2980	0	1344	1484	1100	1298	2597	0	1228	2595	0
Right Turn on Red			No			No			No			No
Satd. Flow (RTOR)												
Link Speed (mph)		20			20			25			25	
Link Distance (ft)		457			941			981			353	
Travel Time (s)		15.6			32.1			26.8			9.6	
Confl. Peds. (#/hr)	125		49	49		125	29		98	98		29
Peak Hour Factor	0.80	0.80	0.80	0.87	0.87	0.87	0.93	0.93	0.93	0.85	0.85	0.85
Heavy Vehicles (%)	5%	5%	5%	7%	7%	7%	10%	10%	10%	7%	7%	7%
Adj. Flow (vph)	88	354	36	75	316	53	32	341	94	42	541	93
Shared Lane Traffic (%)												
Lane Group Flow (vph)	88	390	0	75	316	53	32	435	0	42	634	0
Turn Type	Prot	NA		Prot	NA	pm+ov	Prot	NA		Prot	NA	
Protected Phases	5	2		1	6	7	3	8		7	4	
Permitted Phases						6						
Detector Phase	5	2		1	6	7	3	8		7	4	
Switch Phase												
Minimum Initial (s)	7.0	10.0		7.0	10.0	7.0	7.0	7.0		7.0	7.0	
Minimum Split (s)	15.0	28.2		15.0	28.2	15.0	15.0	28.0		15.0	28.1	
Total Split (s)	22.0	38.0		22.0	38.0	22.0	22.0	38.0		22.0	38.0	
Total Split (%)	18.3%	31.7%		18.3%	31.7%	18.3%	18.3%	31.7%		18.3%	31.7%	
Maximum Green (s)	16.6	31.8		16.1	31.8	16.1	16.1	32.1		16.1	32.3	
Yellow Time (s)	3.0	3.0		3.0	3.0	3.0	3.0	3.3		3.0	3.1	
All-Red Time (s)	2.4	3.2		2.9	3.2	2.9	2.9	2.6		2.9	2.6	
Lost Time Adjust (s)	-0.4	-1.2		-0.9	-1.2	-2.0	-0.9	-0.9		-0.9	-0.7	
Total Lost Time (s)	5.0	5.0		5.0	5.0	3.9	5.0	5.0		5.0	5.0	
Lead/Lag	Lead	Lag		Lead	Lag	Lead	Lead	Lag		Lead	Lag	
Lead-Lag Optimize?												
Vehicle Extension (s)	1.0	3.0		1.0	3.0	1.0	1.0	2.0		1.0	2.0	
Recall Mode	None	C-Max		None	C-Max	None	None	Ped		None	Ped	
Walk Time (s)		7.0			7.0			7.0			7.0	
Flash Dont Walk (s)		15.0			15.0			15.0			15.0	
Pedestrian Calls (#/hr)		0			0			0			0	
Act Effect Green (s)	11.8	52.9		11.2	49.7	61.0	8.6	31.9		9.2	35.1	

Lanes, Volumes, Timings

9: NC 86 (S. Columbia St)/NC 86 (N. Columbia St) & W. Franklin Street/E. Franklin Street 09/01/2020



Lane Group	EBL	EBT	EBR	WBL	WBT	WBR	NBL	NBT	NBR	SBL	SBT	SBR
Actuated g/C Ratio	0.10	0.44		0.09	0.41	0.51	0.07	0.27		0.08	0.29	
v/c Ratio	0.66	0.30		0.57	0.51	0.09	0.33	0.63		0.41	0.84	
Control Delay	77.6	23.7		79.4	22.2	9.1	80.9	21.3		90.1	27.5	
Queue Delay	0.0	0.0		0.0	0.0	0.0	0.0	0.0		0.0	0.2	
Total Delay	77.6	23.7		79.4	22.2	9.1	80.9	21.3		90.1	27.7	
LOS	E	C		E	C	A	F	C		F	C	
Approach Delay		33.6			30.3			25.4			31.6	
Approach LOS		C			C			C			C	
Queue Length 50th (ft)	70	95		61	95	11	17	161		30	157	
Queue Length 95th (ft)	112	138		109	#157	19	m45	155		69	182	
Internal Link Dist (ft)		377			861			901			273	
Turn Bay Length (ft)	250			125			475			125		
Base Capacity (vph)	194	1313		199	614	675	190	758		190	782	
Starvation Cap Reductn	0	0		0	0	0	0	0		0	7	
Spillback Cap Reductn	0	0		0	0	0	0	0		0	0	
Storage Cap Reductn	0	0		0	0	0	0	0		0	0	
Reduced v/c Ratio	0.45	0.30		0.38	0.51	0.08	0.17	0.57		0.22	0.82	

Intersection Summary

Area Type: CBD
 Cycle Length: 120
 Actuated Cycle Length: 120
 Offset: 0 (0%), Referenced to phase 2:EBT and 6:WBT, Start of Green
 Natural Cycle: 90
 Control Type: Actuated-Coordinated
 Maximum v/c Ratio: 0.84
 Intersection Signal Delay: 30.4 Intersection LOS: C
 Intersection Capacity Utilization 65.0% ICU Level of Service C
 Analysis Period (min) 15
 # 95th percentile volume exceeds capacity, queue may be longer.
 Queue shown is maximum after two cycles.
 m Volume for 95th percentile queue is metered by upstream signal.

Splits and Phases: 9: NC 86 (S. Columbia St)/NC 86 (N. Columbia St) & W. Franklin Street/E. Franklin Street

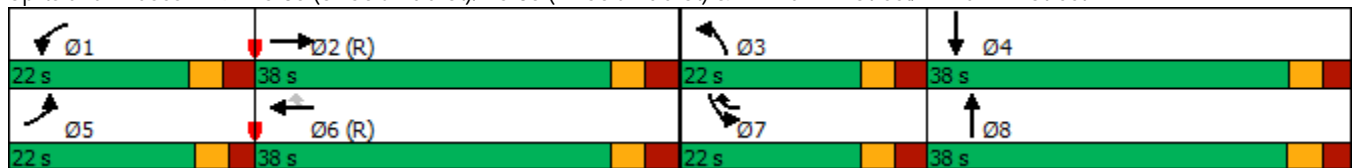

Lanes, Volumes, Timings
 10: E. Franklin Street & Henderson Street

09/01/2020



Lane Group	EBL	EBT	WBT	WBR	SBL	SBR
Lane Configurations		↕↕	↕↔		↔↕	
Traffic Volume (vph)	15	366	384	68	65	17
Future Volume (vph)	15	366	384	68	65	17
Ideal Flow (vphpl)	1900	1900	1900	1900	1900	1900
Lane Width (ft)	10	13	10	10	11	11
Grade (%)		-2%	2%		3%	
Lane Util. Factor	0.95	0.95	0.95	0.95	1.00	1.00
Ped Bike Factor		1.00	0.99		0.95	
Frt			0.977		0.971	
Flt Protected		0.998			0.962	
Satd. Flow (prot)	0	3223	2763	0	1434	0
Flt Permitted		0.933			0.962	
Satd. Flow (perm)	0	3010	2763	0	1387	0
Right Turn on Red				No		No
Satd. Flow (RTOR)						
Link Speed (mph)		20	20		20	
Link Distance (ft)		941	1200		366	
Travel Time (s)		32.1	40.9		12.5	
Confl. Peds. (#/hr)	26			26	44	87
Peak Hour Factor	0.91	0.91	0.90	0.90	0.79	0.79
Heavy Vehicles (%)	5%	5%	5%	5%	4%	4%
Parking (#/hr)						0
Adj. Flow (vph)	16	402	427	76	82	22
Shared Lane Traffic (%)						
Lane Group Flow (vph)	0	418	503	0	104	0
Turn Type	Perm	NA	NA		Prot	
Protected Phases		2	6		4	
Permitted Phases	2					
Detector Phase	2	2	6		4	
Switch Phase						
Minimum Initial (s)	10.0	10.0	10.0		7.0	
Minimum Split (s)	17.0	17.0	22.0		25.0	
Total Split (s)	32.0	32.0	32.0		28.0	
Total Split (%)	53.3%	53.3%	53.3%		46.7%	
Maximum Green (s)	25.8	25.8	25.9		22.9	
Yellow Time (s)	3.0	3.0	3.0		3.0	
All-Red Time (s)	3.2	3.2	3.1		2.1	
Lost Time Adjust (s)		-1.2	-1.1		-0.1	
Total Lost Time (s)		5.0	5.0		5.0	
Lead/Lag						
Lead-Lag Optimize?						
Vehicle Extension (s)	2.0	2.0	2.0		1.0	
Recall Mode	C-Max	C-Max	C-Max		None	
Walk Time (s)			7.0		7.0	
Flash Dont Walk (s)			8.0		12.0	
Pedestrian Calls (#/hr)			0		0	
Act Effct Green (s)		44.6	44.6		8.8	
Actuated g/C Ratio		0.74	0.74		0.15	
v/c Ratio		0.19	0.25		0.50	

Lanes, Volumes, Timings
 10: E. Franklin Street & Henderson Street

09/01/2020



Lane Group	EBL	EBT	WBT	WBR	SBL	SBR
Control Delay		6.7	4.9		28.5	
Queue Delay		0.0	0.0		0.0	
Total Delay		6.7	4.9		28.5	
LOS		A	A		C	
Approach Delay		6.7	4.9		28.5	
Approach LOS		A	A		C	
Queue Length 50th (ft)		97	117		31	
Queue Length 95th (ft)		152	18		49	
Internal Link Dist (ft)		861	1120		286	
Turn Bay Length (ft)						
Base Capacity (vph)		2237	2053		549	
Starvation Cap Reductn		0	0		0	
Spillback Cap Reductn		0	0		0	
Storage Cap Reductn		0	0		0	
Reduced v/c Ratio		0.19	0.25		0.19	

Intersection Summary

Area Type:	CBD
Cycle Length:	60
Actuated Cycle Length:	60
Offset:	53 (88%), Referenced to phase 2:EBTL and 6:WBT, Start of Green
Natural Cycle:	50
Control Type:	Actuated-Coordinated
Maximum v/c Ratio:	0.50
Intersection Signal Delay:	8.0
Intersection LOS:	A
Intersection Capacity Utilization:	47.1%
ICU Level of Service:	A
Analysis Period (min):	15

Splits and Phases: 10: E. Franklin Street & Henderson Street

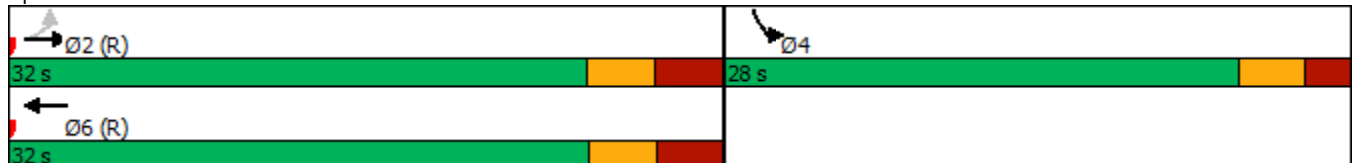

Lanes, Volumes, Timings

11: Raleigh Street/Hillsborough Street & E. Franklin Street

09/01/2020



Lane Group	EBL	EBT	EBR	WBL	WBT	WBR	NBL	NBT	NBR	SBL	SBT	SBR
Lane Configurations												
Traffic Volume (vph)	19	312	103	42	416	84	78	172	23	67	336	18
Future Volume (vph)	19	312	103	42	416	84	78	172	23	67	336	18
Ideal Flow (vphpl)	1900	1900	1900	1900	1900	1900	1900	1900	1900	1900	1900	1900
Lane Width (ft)	9	9	10	9	10	11	12	12	12	10	10	10
Grade (%)		1%			-2%			1%			1%	
Storage Length (ft)	75		0	75		0	0		0	100		0
Storage Lanes	1		0	1		0	0		0	1		0
Taper Length (ft)	25			25			25			25		
Lane Util. Factor	1.00	0.95	0.95	1.00	0.95	0.95	1.00	1.00	1.00	1.00	1.00	1.00
Ped Bike Factor	0.99	0.99		0.99	0.99			0.99		0.99	1.00	
Frt		0.963			0.975			0.989			0.992	
Flt Protected	0.950			0.950				0.986		0.950		
Satd. Flow (prot)	1539	2934	0	1578	3173	0	0	1768	0	1627	1695	0
Flt Permitted	0.404			0.439				0.632		0.502		
Satd. Flow (perm)	651	2934	0	721	3173	0	0	1129	0	852	1695	0
Right Turn on Red			No			No			No			No
Satd. Flow (RTOR)												
Link Speed (mph)		20			30			25			25	
Link Distance (ft)		1200			1013			995			363	
Travel Time (s)		40.9			23.0			27.1			9.9	
Confl. Peds. (#/hr)	9		16	16		9	25		11	11		25
Peak Hour Factor	0.86	0.86	0.86	0.92	0.92	0.92	0.83	0.83	0.83	0.96	0.96	0.96
Heavy Vehicles (%)	5%	5%	5%	4%	4%	4%	4%	4%	4%	3%	3%	3%
Adj. Flow (vph)	22	363	120	46	452	91	94	207	28	70	350	19
Shared Lane Traffic (%)												
Lane Group Flow (vph)	22	483	0	46	543	0	0	329	0	70	369	0
Turn Type	Perm	NA		Perm	NA		pm+pt	NA		D.Pm	NA	
Protected Phases		2			6		7	4				8
Permitted Phases	2			6			4			4		
Detector Phase	2	2		6	6		7	4		4		8
Switch Phase												
Minimum Initial (s)	10.0	10.0		10.0	10.0		7.0	7.0		7.0	7.0	
Minimum Split (s)	16.0	16.0		16.0	16.0		14.0	30.0		30.0	29.0	
Total Split (s)	47.0	47.0		47.0	47.0		28.0	73.0		73.0	45.0	
Total Split (%)	39.2%	39.2%		39.2%	39.2%		23.3%	60.8%		60.8%	37.5%	
Maximum Green (s)	41.7	41.7		41.7	41.7		21.8	66.6		66.6	38.6	
Yellow Time (s)	3.0	3.0		3.0	3.0		3.0	3.1		3.1	3.1	
All-Red Time (s)	2.3	2.3		2.3	2.3		3.2	3.3		3.3	3.3	
Lost Time Adjust (s)	-0.3	-0.3		-0.3	-0.3			-1.4		-1.4	-1.4	
Total Lost Time (s)	5.0	5.0		5.0	5.0			5.0		5.0	5.0	
Lead/Lag							Lead				Lag	
Lead-Lag Optimize?												
Vehicle Extension (s)	3.0	3.0		3.0	3.0		3.0	2.0		2.0	2.0	
Recall Mode	C-Max	C-Max		C-Max	C-Max		None	None		None	None	
Walk Time (s)								7.0		7.0	7.0	
Flash Dont Walk (s)								16.0		16.0	15.0	
Pedestrian Calls (#/hr)								0		0	0	
Act Effect Green (s)	60.7	60.7		60.7	60.7			49.3		49.3	49.3	

Lanes, Volumes, Timings

11: Raleigh Street/Hillsborough Street & E. Franklin Street

09/01/2020



Lane Group	EBL	EBT	EBR	WBL	WBT	WBR	NBL	NBT	NBR	SBL	SBT	SBR
Actuated g/C Ratio	0.51	0.51		0.51	0.51			0.41		0.41	0.41	
v/c Ratio	0.07	0.33		0.13	0.34			0.71		0.20	0.53	
Control Delay	13.9	13.2		22.0	20.8			36.7		17.1	24.2	
Queue Delay	0.0	0.0		0.0	0.0			0.0		0.0	2.4	
Total Delay	13.9	13.2		22.0	20.8			36.7		17.1	26.5	
LOS	B	B		C	C			D		B	C	
Approach Delay		13.3			20.9			36.7			25.0	
Approach LOS		B			C			D			C	
Queue Length 50th (ft)	6	70		18	128			207		33	198	
Queue Length 95th (ft)	15	86		53	218			217		54	234	
Internal Link Dist (ft)		1120			933			915			283	
Turn Bay Length (ft)	75			75						100		
Base Capacity (vph)	329	1484		365	1605			639		482	718	
Starvation Cap Reductn	0	0		0	0			0		0	225	
Spillback Cap Reductn	0	0		0	0			0		0	0	
Storage Cap Reductn	0	0		0	0			0		0	0	
Reduced v/c Ratio	0.07	0.33		0.13	0.34			0.51		0.15	0.75	

Intersection Summary

Area Type:	Other
Cycle Length:	120
Actuated Cycle Length:	120
Offset:	61 (51%), Referenced to phase 2:EBTL and 6:WBTL, Start of Green
Natural Cycle:	60
Control Type:	Actuated-Coordinated
Maximum v/c Ratio:	0.71
Intersection Signal Delay:	22.6
Intersection LOS:	C
Intersection Capacity Utilization	74.4%
ICU Level of Service	D
Analysis Period (min)	15

Splits and Phases: 11: Raleigh Street/Hillsborough Street & E. Franklin Street

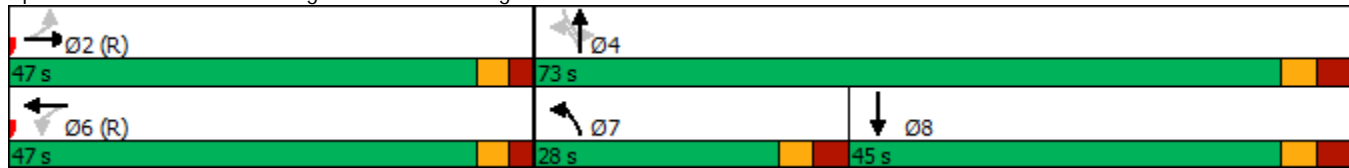

Lanes, Volumes, Timings

13: NC 86 (N. Columbia St)/NC 86 (MLK Jr. Blvd) & North Street & N. Columbia Street 09/01/2020



Lane Group	WBL	WBR	WBR2	NBL	NBT	NBR	SBL	SBT	SBR	SEL2	SEL	SER
Lane Configurations												
Traffic Volume (vph)	2	3	20	38	434	3	76	734	2	2	6	54
Future Volume (vph)	2	3	20	38	434	3	76	734	2	2	6	54
Ideal Flow (vphpl)	1900	1900	1900	1900	1900	1900	1900	1900	1900	1900	1900	1900
Grade (%)	2%				-5%			5%				-3%
Storage Length (ft)	0	0		150		0	70		0		0	0
Storage Lanes	1	0		1		0	1		0		1	0
Taper Length (ft)	25			25			25				25	
Lane Util. Factor	1.00	1.00	1.00	1.00	0.95	0.95	1.00	0.95	0.95	1.00	1.00	1.00
Ped Bike Factor				1.00	1.00		0.99	1.00				
Frt	0.875				0.999							0.883
Flt Protected	0.996			0.950			0.950				0.993	
Satd. Flow (prot)	1490	0	0	1729	3454	0	1676	3352	0	0	1566	0
Flt Permitted	0.996			0.311			0.477				0.993	
Satd. Flow (perm)	1490	0	0	566	3454	0	836	3352	0	0	1566	0
Right Turn on Red				No		No			No			No
Satd. Flow (RTOR)												
Link Speed (mph)	20				35			35				25
Link Distance (ft)	263				476			2108				715
Travel Time (s)	9.0				9.3			41.1				19.5
Confl. Peds. (#/hr)				1		15	15		1			
Peak Hour Factor	0.48	0.48	0.48	0.93	0.93	0.93	0.89	0.89	0.89	0.76	0.76	0.76
Heavy Vehicles (%)	10%	10%	10%	7%	7%	7%	5%	5%	5%	8%	8%	8%
Adj. Flow (vph)	4	6	42	41	467	3	85	825	2	3	8	71
Shared Lane Traffic (%)												
Lane Group Flow (vph)	52	0	0	41	470	0	85	827	0	0	82	0
Turn Type	Prot			Perm	NA		Perm	NA		Prot	Prot	
Protected Phases	3				2			6		4	4	
Permitted Phases				2			6					
Detector Phase	3			2	2		6	6		4	4	
Switch Phase												
Minimum Initial (s)	7.0			10.0	10.0		10.0	10.0		7.0	7.0	
Minimum Split (s)	14.0			17.0	17.0		17.0	17.0		14.0	14.0	
Total Split (s)	23.0			70.0	70.0		70.0	70.0		27.0	27.0	
Total Split (%)	19.2%			58.3%	58.3%		58.3%	58.3%		22.5%	22.5%	
Maximum Green (s)	16.0			63.0	63.0		63.0	63.0		20.0	20.0	
Yellow Time (s)	5.0			5.0	5.0		5.0	5.0		5.0	5.0	
All-Red Time (s)	2.0			2.0	2.0		2.0	2.0		2.0	2.0	
Lost Time Adjust (s)	-2.0			-2.0	-2.0		-2.0	-2.0			-2.0	
Total Lost Time (s)	5.0			5.0	5.0		5.0	5.0			5.0	
Lead/Lag	Lead									Lag	Lag	
Lead-Lag Optimize?	Yes									Yes	Yes	
Vehicle Extension (s)	3.0			3.0	3.0		3.0	3.0		3.0	3.0	
Recall Mode	None			C-Max	C-Max		C-Max	C-Max		None	None	
Act Effct Green (s)	11.8			86.1	86.1		86.1	86.1			13.6	
Actuated g/C Ratio	0.10			0.72	0.72		0.72	0.72			0.11	
v/c Ratio	0.36			0.10	0.19		0.14	0.34			0.46	
Control Delay	56.5			4.5	3.7		9.5	9.5			57.3	
Queue Delay	0.0			0.0	0.0		0.0	0.0			0.0	

Lanes, Volumes, Timings

13: NC 86 (N. Columbia St)/NC 86 (MLK Jr. Blvd) & North Street & N. Columbia Street 09/01/2020



Lane Group	WBL	WBR	WBR2	NBL	NBT	NBR	SBL	SBT	SBR	SEL2	SEL	SER
Total Delay	56.5			4.5	3.7		9.5	9.5			57.3	
LOS	E			A	A		A	A			E	
Approach Delay	56.5				3.7			9.5			57.3	
Approach LOS	E				A			A			E	
Queue Length 50th (ft)	38			4	22		22	136			60	
Queue Length 95th (ft)	40			m8	30		55	213			90	
Internal Link Dist (ft)	183				396			2028			635	
Turn Bay Length (ft)				150			70					
Base Capacity (vph)	223			406	2478		599	2405			287	
Starvation Cap Reductn	0			0	0		0	0			0	
Spillback Cap Reductn	0			0	0		0	0			0	
Storage Cap Reductn	0			0	0		0	0			0	
Reduced v/c Ratio	0.23			0.10	0.19		0.14	0.34			0.29	

Intersection Summary

Area Type: Other
 Cycle Length: 120
 Actuated Cycle Length: 120
 Offset: 58 (48%), Referenced to phase 2:NBTL and 6:SBTL, Start of Green
 Natural Cycle: 50
 Control Type: Actuated-Coordinated
 Maximum v/c Ratio: 0.46
 Intersection Signal Delay: 11.7 Intersection LOS: B
 Intersection Capacity Utilization 57.0% ICU Level of Service B
 Analysis Period (min) 15
 m Volume for 95th percentile queue is metered by upstream signal.

Splits and Phases: 13: NC 86 (N. Columbia St)/NC 86 (MLK Jr. Blvd) & North Street & N. Columbia Street

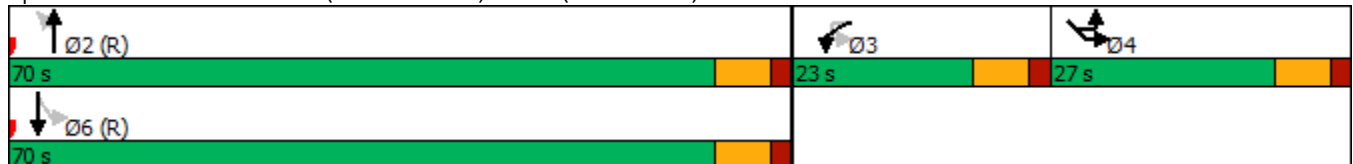

Lanes, Volumes, Timings

14: NC 86 (MLK Jr. Blvd) & Longview Street/Mill Creek Apts Driveway

09/01/2020



Lane Group	EBL	EBT	EBR	WBL	WBT	WBR	NBL	NBT	NBR	SBL	SBT	SBR
Lane Configurations		↕			↕		↕	↕↔		↕	↕↔	
Traffic Volume (vph)	77	0	10	6	0	5	2	432	5	0	724	66
Future Volume (vph)	77	0	10	6	0	5	2	432	5	0	724	66
Ideal Flow (vphpl)	1900	1900	1900	1900	1900	1900	1900	1900	1900	1900	1900	1900
Grade (%)		-6%			1%			2%			-4%	
Storage Length (ft)	0		0	0		0	225		0	250		0
Storage Lanes	0		0	0		0	1		0	1		0
Taper Length (ft)	25			25			25			25		
Lane Util. Factor	1.00	1.00	1.00	1.00	1.00	1.00	1.00	0.95	0.95	1.00	0.95	0.95
Ped Bike Factor		1.00			0.99		1.00	1.00			1.00	
Frt		0.985			0.944			0.998			0.987	
Flt Protected		0.958			0.972		0.950					
Satd. Flow (prot)	0	1737	0	0	1701	0	1686	3364	0	1846	3453	0
Flt Permitted		0.742			0.816		0.259					
Satd. Flow (perm)	0	1345	0	0	1418	0	459	3364	0	1846	3453	0
Right Turn on Red			No			No			No			No
Satd. Flow (RTOR)												
Link Speed (mph)		25			20			35			35	
Link Distance (ft)		451			338			2108			784	
Travel Time (s)		12.3			11.5			41.1			15.3	
Confl. Peds. (#/hr)			16	16			4		4	4		4
Peak Hour Factor	0.52	0.52	0.52	0.92	0.92	0.92	0.93	0.93	0.93	0.84	0.84	0.84
Heavy Vehicles (%)	6%	6%	6%	2%	2%	2%	6%	6%	6%	5%	5%	5%
Adj. Flow (vph)	148	0	19	7	0	5	2	465	5	0	862	79
Shared Lane Traffic (%)												
Lane Group Flow (vph)	0	167	0	0	12	0	2	470	0	0	941	0
Turn Type	Perm	NA		Perm	NA		Perm	NA		Perm	NA	
Protected Phases		4			8			2			6	
Permitted Phases	4			8			2			6		
Detector Phase	4	4		8	8		2	2		6	6	
Switch Phase												
Minimum Initial (s)	7.0	7.0		7.0	7.0		12.0	12.0		12.0	12.0	
Minimum Split (s)	31.0	31.0		14.0	14.0		28.0	28.0		28.0	28.0	
Total Split (s)	20.0	20.0		20.0	20.0		60.0	60.0		60.0	60.0	
Total Split (%)	25.0%	25.0%		25.0%	25.0%		75.0%	75.0%		75.0%	75.0%	
Maximum Green (s)	14.0	14.0		13.9	13.9		54.0	54.0		54.5	54.5	
Yellow Time (s)	3.5	3.5		3.0	3.0		4.5	4.5		4.0	4.0	
All-Red Time (s)	2.5	2.5		3.1	3.1		1.5	1.5		1.5	1.5	
Lost Time Adjust (s)		-1.0			-1.0		-1.0	-1.0		-0.5	-0.5	
Total Lost Time (s)		5.0			5.1		5.0	5.0		5.0	5.0	
Lead/Lag												
Lead-Lag Optimize?												
Vehicle Extension (s)	3.0	3.0		3.0	3.0		3.0	3.0		3.0	3.0	
Recall Mode	None	None		None	None		Min	Min		Min	Min	
Walk Time (s)	7.0	7.0					7.0	7.0		7.0	7.0	
Flash Dont Walk (s)	17.0	17.0					9.0	9.0		9.0	9.0	
Pedestrian Calls (#/hr)	0	0					0	0		0	0	
Act Effct Green (s)		11.8			11.7		22.5	22.5			22.5	
Actuated g/C Ratio		0.27			0.26		0.51	0.51			0.51	

Lanes, Volumes, Timings

14: NC 86 (MLK Jr. Blvd) & Longview Street/Mill Creek Apts Driveway

09/01/2020



Lane Group	EBL	EBT	EBR	WBL	WBT	WBR	NBL	NBT	NBR	SBL	SBT	SBR
v/c Ratio		0.47			0.03		0.01	0.28				0.54
Control Delay		18.6			12.8		6.0	7.1				9.2
Queue Delay		0.0			0.0		0.0	0.0				0.0
Total Delay		18.6			12.8		6.0	7.1				9.2
LOS		B			B		A	A				A
Approach Delay		18.6			12.8			7.1				9.2
Approach LOS		B			B			A				A
Queue Length 50th (ft)		31			2		0	31				73
Queue Length 95th (ft)		44			12		3	60				118
Internal Link Dist (ft)		371			258			2028				704
Turn Bay Length (ft)							225					
Base Capacity (vph)		461			483		459	3364				3453
Starvation Cap Reductn		0			0		0	0				0
Spillback Cap Reductn		0			0		0	0				0
Storage Cap Reductn		0			0		0	0				0
Reduced v/c Ratio		0.36			0.02		0.00	0.14				0.27

Intersection Summary

Area Type:	Other
Cycle Length:	80
Actuated Cycle Length:	44.4
Natural Cycle:	60
Control Type:	Actuated-Uncoordinated
Maximum v/c Ratio:	0.54
Intersection Signal Delay:	9.6
Intersection LOS:	A
Intersection Capacity Utilization:	43.2%
ICU Level of Service:	A
Analysis Period (min):	15

Splits and Phases: 14: NC 86 (MLK Jr. Blvd) & Longview Street/Mill Creek Apts Driveway



Lanes, Volumes, Timings
 15: NC 86 (Pittsboro St) & W. Cameron Avenue

09/01/2020



Lane Group	EBT	EBR	WBL	WBT	NBL	NBR	Ø1	Ø4
Lane Configurations	↶		↶↶	↶				
Traffic Volume (vph)	117	159	601	134	0	0		
Future Volume (vph)	117	159	601	134	0	0		
Ideal Flow (vphpl)	1900	1900	1900	1900	1900	1900		
Lane Width (ft)	12	12	11	12	12	12		
Grade (%)	3%			-3%	0%			
Storage Length (ft)		0	75		0	0		
Storage Lanes		0	0		0	0		
Taper Length (ft)			25		25			
Lane Util. Factor	1.00	1.00	0.97	1.00	1.00	1.00		
Ped Bike Factor	0.94		0.90					
Frt	0.922							
Flt Protected			0.950					
Satd. Flow (prot)	1432	0	2837	1592	0	0		
Flt Permitted			0.950					
Satd. Flow (perm)	1432	0	2562	1592	0	0		
Right Turn on Red		No				No		
Satd. Flow (RTOR)								
Link Speed (mph)	25			25	25			
Link Distance (ft)	391			120	794			
Travel Time (s)	30.0			10.7	21.7			
Confl. Peds. (#/hr)		57	57					
Peak Hour Factor	0.81	0.81	0.87	0.87	0.90	0.90		
Heavy Vehicles (%)	2%	2%	9%	9%	2%	2%		
Adj. Flow (vph)	144	196	691	154	0	0		
Shared Lane Traffic (%)								
Lane Group Flow (vph)	340	0	691	154	0	0		
Turn Type	NA		Prot	NA				
Protected Phases	2		1 4	6			1	4
Permitted Phases								
Detector Phase	2		1 4	6				
Switch Phase								
Minimum Initial (s)	10.0			10.0			7.0	7.0
Minimum Split (s)	17.0			15.0			13.0	20.0
Total Split (s)	25.0			40.0			15.0	20.0
Total Split (%)	41.7%			66.7%			25%	33%
Maximum Green (s)	19.9			35.0			9.9	16.0
Yellow Time (s)	3.0			3.3			3.0	3.0
All-Red Time (s)	2.1			1.7			2.1	1.0
Lost Time Adjust (s)	-0.1			0.0				
Total Lost Time (s)	5.0			5.0				
Lead/Lag	Lag						Lead	
Lead-Lag Optimize?								
Vehicle Extension (s)	1.0			1.0			4.0	0.2
Recall Mode	None			C-Max			C-Max	None
Walk Time (s)	7.0							7.0
Flash Dont Walk (s)	4.0							9.0
Pedestrian Calls (#/hr)	0							0
Act Effect Green (s)	20.0		30.0	38.8				

Lanes, Volumes, Timings
 15: NC 86 (Pittsboro St) & W. Cameron Avenue

09/01/2020



Lane Group	EBT	EBR	WBL	WBT	NBL	NBR	Ø1	Ø4
Actuated g/C Ratio	0.33		0.50	0.65				
v/c Ratio	0.71		0.49	0.15				
Control Delay	28.0		14.4	5.9				
Queue Delay	0.0		0.0	0.0				
Total Delay	28.0		14.4	5.9				
LOS	C		B	A				
Approach Delay	28.0			12.9				
Approach LOS	C			B				
Queue Length 50th (ft)	105		190	30				
Queue Length 95th (ft)	163		186	m84				
Internal Link Dist (ft)	311			40	714			
Turn Bay Length (ft)			75					
Base Capacity (vph)	477		1374	1028				
Starvation Cap Reductn	0		0	0				
Spillback Cap Reductn	0		0	0				
Storage Cap Reductn	0		0	0				
Reduced v/c Ratio	0.71		0.50	0.15				

Intersection Summary

Area Type: CBD
 Cycle Length: 60
 Actuated Cycle Length: 60
 Offset: 23 (38%), Referenced to phase 1:WBL and 6:WBT, Start of Green
 Natural Cycle: 60
 Control Type: Actuated-Coordinated
 Maximum v/c Ratio: 0.71
 Intersection Signal Delay: 17.2 Intersection LOS: B
 Intersection Capacity Utilization 47.5% ICU Level of Service A
 Analysis Period (min) 15
 m Volume for 95th percentile queue is metered by upstream signal.

Splits and Phases: 15: NC 86 (Pittsboro St) & W. Cameron Avenue

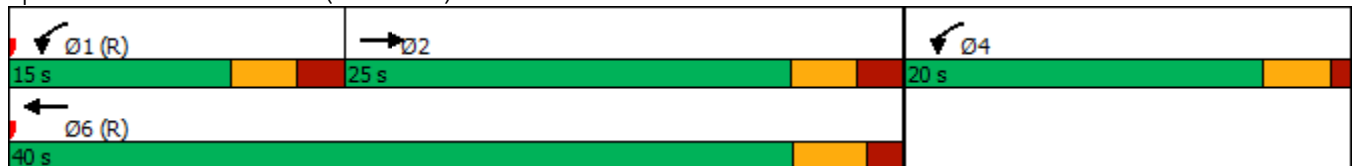

Lanes, Volumes, Timings

16: NC 86 (S. Columbia St) & W. Cameron Avenue/E. Cameron Avenue

09/01/2020



Lane Group	EBL	EBT	EBR	WBL	WBT	WBR	NBL	NBT	NBR	SBL	SBT	SBR
Lane Configurations												
Traffic Volume (vph)	16	91	0	0	95	20	98	391	43	66	0	538
Future Volume (vph)	16	91	0	0	95	20	98	391	43	66	0	538
Ideal Flow (vphp)	1900	1900	1900	1900	1900	1900	1900	1900	1900	1900	1900	1900
Lane Width (ft)	11	12	12	12	12	12	10	10	10	11	11	12
Grade (%)		1%			-1%			1%			2%	
Storage Length (ft)	100		0	0		0	0		0	310		0
Storage Lanes	1		0	0		0	1		0	1		2
Taper Length (ft)	25			25			25			25		
Lane Util. Factor	1.00	1.00	1.00	1.00	1.00	1.00	0.91	0.91	0.95	1.00	1.00	0.88
Ped Bike Factor	0.95				0.99		0.79	0.95		0.75		0.77
Frt					0.977			0.985				0.850
Flt Protected	0.950						0.950	0.999		0.950		
Satd. Flow (prot)	1532	1668	0	0	1565	0	1248	2456	0	1413	0	2302
Flt Permitted	0.522						0.950	0.999		0.950		
Satd. Flow (perm)	803	1668	0	0	1565	0	982	2445	0	1063	0	1776
Right Turn on Red			No			No			No			No
Satd. Flow (RTOR)												
Link Speed (mph)		25			25			25				25
Link Distance (ft)		273			989			826				981
Travel Time (s)		10.7			57.6			22.5				26.8
Confl. Peds. (#/hr)	39		102	102		39	71		107	107		71
Peak Hour Factor	0.79	0.79	0.79	0.83	0.83	0.83	0.86	0.86	0.86	0.89	0.89	0.89
Heavy Vehicles (%)	2%	2%	2%	6%	6%	6%	10%	10%	10%	10%	10%	10%
Adj. Flow (vph)	20	115	0	0	114	24	114	455	50	74	0	604
Shared Lane Traffic (%)							10%					
Lane Group Flow (vph)	20	115	0	0	138	0	103	516	0	74	0	604
Turn Type	Perm	NA			NA		Split	NA		Prot		Prot
Protected Phases		4			8		2	2		1		1
Permitted Phases	4									1		1
Detector Phase	4	4			8		2	2		1		1
Switch Phase												
Minimum Initial (s)	10.0	10.0			10.0		7.0	7.0		7.0		7.0
Minimum Split (s)	24.0	24.0			31.0		18.0	18.0		26.0		26.0
Total Split (s)	34.0	34.0			34.0		22.0	22.0		36.0		36.0
Total Split (%)	28.3%	28.3%			28.3%		18.3%	18.3%		30.0%		30.0%
Maximum Green (s)	27.8	27.8			27.8		16.1	16.1		30.4		30.4
Yellow Time (s)	3.2	3.2			3.2		3.1	3.1		3.0		3.0
All-Red Time (s)	3.0	3.0			3.0		2.8	2.8		2.6		2.6
Lost Time Adjust (s)	-1.2	-1.2			-1.2		-0.9	-0.9		-0.6		-0.6
Total Lost Time (s)	5.0	5.0			5.0		5.0	5.0		5.0		5.0
Lead/Lag							Lag	Lag		Lead		Lead
Lead-Lag Optimize?							Yes	Yes		Yes		Yes
Vehicle Extension (s)	2.0	2.0			2.0		4.0	4.0		4.0		4.0
Recall Mode	None	None			None		C-Max	C-Max		None		None
Walk Time (s)	7.0	7.0			7.0		7.0	7.0		7.0		7.0
Flash Dont Walk (s)	10.0	10.0			17.0		5.0	5.0		13.0		13.0
Pedestrian Calls (#/hr)	0	0			0		0	0		0		0
Act Effect Green (s)	16.4	16.4			16.4		46.7	46.7		41.9		41.9

Lanes, Volumes, Timings

16: NC 86 (S. Columbia St) & W. Cameron Avenue/E. Cameron Avenue

09/01/2020

Lane Group	Ø9
Lane Configurations	
Traffic Volume (vph)	
Future Volume (vph)	
Ideal Flow (vphpl)	
Lane Width (ft)	
Grade (%)	
Storage Length (ft)	
Storage Lanes	
Taper Length (ft)	
Lane Util. Factor	
Ped Bike Factor	
Frt	
Flt Protected	
Satd. Flow (prot)	
Flt Permitted	
Satd. Flow (perm)	
Right Turn on Red	
Satd. Flow (RTOR)	
Link Speed (mph)	
Link Distance (ft)	
Travel Time (s)	
Confl. Peds. (#/hr)	
Peak Hour Factor	
Heavy Vehicles (%)	
Adj. Flow (vph)	
Shared Lane Traffic (%)	
Lane Group Flow (vph)	
Turn Type	
Protected Phases	9
Permitted Phases	
Detector Phase	
Switch Phase	
Minimum Initial (s)	7.0
Minimum Split (s)	28.0
Total Split (s)	28.0
Total Split (%)	23%
Maximum Green (s)	24.0
Yellow Time (s)	3.0
All-Red Time (s)	1.0
Lost Time Adjust (s)	
Total Lost Time (s)	
Lead/Lag	
Lead-Lag Optimize?	
Vehicle Extension (s)	0.2
Recall Mode	None
Walk Time (s)	7.0
Flash Dont Walk (s)	17.0
Pedestrian Calls (#/hr)	0
Act Effect Green (s)	

Lanes, Volumes, Timings

16: NC 86 (S. Columbia St) & W. Cameron Avenue/E. Cameron Avenue

09/01/2020



Lane Group	EBL	EBT	EBR	WBL	WBT	WBR	NBL	NBT	NBR	SBL	SBT	SBR
Actuated g/C Ratio	0.14	0.14			0.14		0.39	0.39		0.35		0.35
v/c Ratio	0.18	0.50			0.64		0.21	0.54		0.15		0.75
Control Delay	36.2	41.1			62.3		28.0	32.3		7.1		16.6
Queue Delay	0.0	0.0			0.0		0.0	0.0		0.0		0.0
Total Delay	36.2	41.1			62.3		28.0	32.3		7.1		16.6
LOS	D	D			E		C	C		A		B
Approach Delay		40.4			62.3			31.6				15.6
Approach LOS		D			E			C				B
Queue Length 50th (ft)	11	82			103		57	167		5		84
Queue Length 95th (ft)	m15	m109			148		110	239		m16		269
Internal Link Dist (ft)		193			909			746				901
Turn Bay Length (ft)	100									310		
Base Capacity (vph)	194	403			378		485	954		493		803
Starvation Cap Reductn	0	0			0		0	0		0		0
Spillback Cap Reductn	0	0			0		0	0		0		0
Storage Cap Reductn	0	0			0		0	0		0		0
Reduced v/c Ratio	0.10	0.29			0.37		0.21	0.54		0.15		0.75

Intersection Summary

Area Type: CBD
 Cycle Length: 120
 Actuated Cycle Length: 120
 Offset: 39 (33%), Referenced to phase 2:NBTL, Start of Green
 Natural Cycle: 125
 Control Type: Actuated-Coordinated
 Maximum v/c Ratio: 0.75
 Intersection Signal Delay: 28.1 Intersection LOS: C
 Intersection Capacity Utilization 67.9% ICU Level of Service C
 Analysis Period (min) 15
 m Volume for 95th percentile queue is metered by upstream signal.

Splits and Phases: 16: NC 86 (S. Columbia St) & W. Cameron Avenue/E. Cameron Avenue

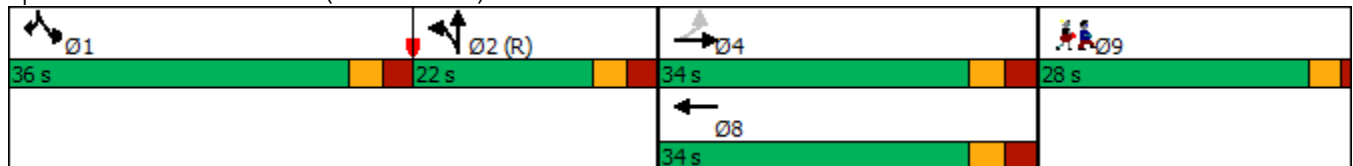

Lanes, Volumes, Timings

16: NC 86 (S. Columbia St) & W. Cameron Avenue/E. Cameron Avenue

09/01/2020

Lane Group	Ø9
Actuated g/C Ratio	
v/c Ratio	
Control Delay	
Queue Delay	
Total Delay	
LOS	
Approach Delay	
Approach LOS	
Queue Length 50th (ft)	
Queue Length 95th (ft)	
Internal Link Dist (ft)	
Turn Bay Length (ft)	
Base Capacity (vph)	
Starvation Cap Reductn	
Spillback Cap Reductn	
Storage Cap Reductn	
Reduced v/c Ratio	
Intersection Summary	

Lanes, Volumes, Timings

17: Raleigh Street & E. Cameron Avenue/Country Club Road

09/01/2020



Lane Group	EBL	EBT	EBR	WBL	WBT	WBR	NBL	NBT	NBR	SBL	SBT	SBR
Lane Configurations		↕		↖	↗		↖	↗		↖	↗	
Traffic Volume (vph)	23	44	32	28	142	210	24	45	17	298	148	48
Future Volume (vph)	23	44	32	28	142	210	24	45	17	298	148	48
Ideal Flow (vphpl)	1900	1900	1900	1900	1900	1900	1900	1900	1900	1900	1900	1900
Grade (%)		-3%			3%			-2%				1%
Storage Length (ft)	0		0	150		0	125		0	75		0
Storage Lanes	0		0	1		0	1		0	1		0
Taper Length (ft)	25			25			25			25		
Lane Util. Factor	1.00	1.00	1.00	1.00	1.00	1.00	1.00	1.00	1.00	1.00	1.00	1.00
Ped Bike Factor		0.98		0.98	0.98		0.91	0.96		0.89	0.95	
Frt		0.956			0.911			0.958			0.963	
Flt Protected		0.989		0.950			0.950			0.950		
Satd. Flow (prot)	0	1493	0	1569	1474	0	1492	1446	0	1569	1509	0
Flt Permitted		0.834		0.568			0.628			0.455		
Satd. Flow (perm)	0	1257	0	924	1474	0	896	1446	0	671	1509	0
Right Turn on Red			No			No			No			No
Satd. Flow (RTOR)												
Link Speed (mph)		25			25			25				25
Link Distance (ft)		598			651			409				995
Travel Time (s)		16.3			17.8			11.2				27.1
Confl. Peds. (#/hr)	3		6	6		3	31		25	25		31
Peak Hour Factor	0.71	0.71	0.71	0.84	0.84	0.84	0.79	0.79	0.79	0.94	0.94	0.94
Heavy Vehicles (%)	8%	8%	8%	2%	2%	2%	10%	10%	10%	3%	3%	3%
Adj. Flow (vph)	32	62	45	33	169	250	30	57	22	317	157	51
Shared Lane Traffic (%)												
Lane Group Flow (vph)	0	139	0	33	419	0	30	79	0	317	208	0
Turn Type	Perm	NA		pm+pt	NA		pm+pt	NA		pm+pt	NA	
Protected Phases		2		1	6		3	8		7	4	
Permitted Phases	2			6			8			4		
Detector Phase	2	2		1	6		3	8		7	4	
Switch Phase												
Minimum Initial (s)	10.0	10.0		7.0	10.0		7.0	7.0		7.0	7.0	
Minimum Split (s)	18.0	18.0		13.0	19.0		13.0	19.0		12.0	16.0	
Total Split (s)	50.0	50.0		20.0	70.0		20.0	35.0		20.0	35.0	
Total Split (%)	40.0%	40.0%		16.0%	56.0%		16.0%	28.0%		16.0%	28.0%	
Maximum Green (s)	43.9	43.9		14.4	64.4		14.7	29.7		15.1	29.9	
Yellow Time (s)	3.3	3.3		3.0	3.1		3.0	3.1		3.0	3.1	
All-Red Time (s)	2.8	2.8		2.6	2.5		2.3	2.2		1.9	2.0	
Lost Time Adjust (s)		-1.1		-0.6	-0.6		-0.3	-0.3		0.1	-0.1	
Total Lost Time (s)		5.0		5.0	5.0		5.0	5.0		5.0	5.0	
Lead/Lag	Lag	Lag		Lead			Lead	Lag		Lead	Lag	
Lead-Lag Optimize?	Yes	Yes		Yes			Yes	Yes		Yes	Yes	
Vehicle Extension (s)	2.0	2.0		2.0	2.0		2.0	2.0		2.0	2.0	
Recall Mode	None	None		None	None		None	None		None	None	
Walk Time (s)	4.0	4.0			4.0			4.0			4.0	
Flash Dont Walk (s)	7.0	7.0			9.0			9.0			6.0	
Pedestrian Calls (#/hr)	0	0			0			0			0	
Act Effect Green (s)		19.4		23.3	23.3		15.3	10.0		25.2	21.3	
Actuated g/C Ratio		0.32		0.39	0.39		0.26	0.17		0.42	0.36	

Lanes, Volumes, Timings

17: Raleigh Street & E. Cameron Avenue/Country Club Road

09/01/2020



Lane Group	EBL	EBT	EBR	WBL	WBT	WBR	NBL	NBT	NBR	SBL	SBT	SBR
v/c Ratio		0.34		0.07	0.73		0.10	0.33		0.63	0.39	
Control Delay		22.5		12.6	24.8		14.4	31.5		21.2	21.6	
Queue Delay		0.0		0.0	0.0		0.0	0.0		0.0	0.0	
Total Delay		22.5		12.6	24.8		14.4	31.5		21.2	21.6	
LOS		C		B	C		B	C		C	C	
Approach Delay		22.5			23.9			26.8			21.4	
Approach LOS		C			C			C			C	
Queue Length 50th (ft)		35		8	132		6	27		75	46	
Queue Length 95th (ft)		79		23	227		22	67		#212	162	
Internal Link Dist (ft)		518			571			329			915	
Turn Bay Length (ft)				150			125			75		
Base Capacity (vph)		941		568	1391		528	818		564	853	
Starvation Cap Reductn		0		0	0		0	0		0	0	
Spillback Cap Reductn		0		0	0		0	0		0	0	
Storage Cap Reductn		0		0	0		0	0		0	0	
Reduced v/c Ratio		0.15		0.06	0.30		0.06	0.10		0.56	0.24	

Intersection Summary

Area Type: CBD
 Cycle Length: 125
 Actuated Cycle Length: 59.8
 Natural Cycle: 65
 Control Type: Actuated-Uncoordinated
 Maximum v/c Ratio: 0.73
 Intersection Signal Delay: 22.9
 Intersection LOS: C
 Intersection Capacity Utilization 61.6%
 ICU Level of Service B
 Analysis Period (min) 15
 # 95th percentile volume exceeds capacity, queue may be longer.
 Queue shown is maximum after two cycles.

Splits and Phases: 17: Raleigh Street & E. Cameron Avenue/Country Club Road

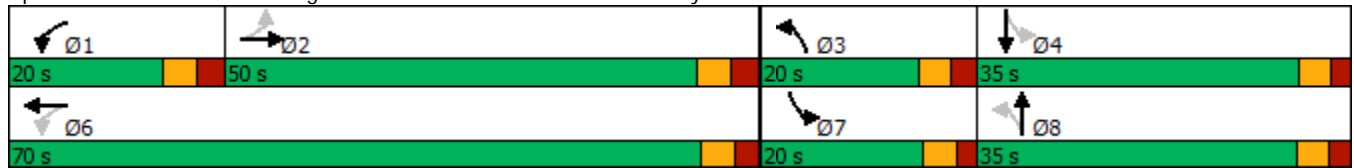

Lanes, Volumes, Timings
1: Church Street & W. Rosemary Street

09/01/2020



Lane Group	EBL	EBT	EBR	WBL	WBT	WBR	NBL	NBT	NBR	SBL	SBT	SBR
Lane Configurations		↕			↕			↕			↕	
Traffic Volume (vph)	6	323	29	44	352	24	23	42	57	14	33	10
Future Volume (vph)	6	323	29	44	352	24	23	42	57	14	33	10
Ideal Flow (vphpl)	1900	1900	1900	1900	1900	1900	1900	1900	1900	1900	1900	1900
Lane Width (ft)	12	14	12	12	14	12	12	12	12	12	12	12
Grade (%)		1%			-1%			0%			0%	
Lane Util. Factor	1.00	1.00	1.00	1.00	1.00	1.00	1.00	1.00	1.00	1.00	1.00	1.00
Ped Bike Factor		0.99			0.99			0.92			0.95	
Frt		0.989			0.992			0.937			0.976	
Flt Protected		0.999			0.995			0.991			0.988	
Satd. Flow (prot)	0	1709	0	0	1748	0	0	1478	0	0	1562	0
Flt Permitted		0.994			0.934			0.922			0.919	
Satd. Flow (perm)	0	1700	0	0	1634	0	0	1335	0	0	1428	0
Right Turn on Red			No			No			No			No
Satd. Flow (RTOR)												
Link Speed (mph)		20			20			25			25	
Link Distance (ft)		964			757			379			430	
Travel Time (s)		32.9			25.8			10.3			11.7	
Confl. Peds. (#/hr)	22		24	24		22	75		39	39		75
Peak Hour Factor	0.88	0.88	0.88	0.93	0.93	0.93	0.92	0.92	0.92	0.64	0.64	0.64
Heavy Vehicles (%)	4%	4%	4%	3%	3%	3%	2%	2%	2%	2%	2%	2%
Adj. Flow (vph)	7	367	33	47	378	26	25	46	62	22	52	16
Shared Lane Traffic (%)												
Lane Group Flow (vph)	0	407	0	0	451	0	0	133	0	0	90	0
Turn Type	Perm	NA		Perm	NA		Perm	NA		Perm	NA	
Protected Phases		2			6			8			4	
Permitted Phases	2			6			8			4		
Detector Phase	2	2		6	6		8	8		4	4	
Switch Phase												
Minimum Initial (s)	10.0	10.0		10.0	10.0		7.0	7.0		7.0	7.0	
Minimum Split (s)	19.0	19.0		20.0	20.0		19.0	19.0		19.0	19.0	
Total Split (s)	43.0	43.0		43.0	43.0		22.0	22.0		22.0	22.0	
Total Split (%)	66.2%	66.2%		66.2%	66.2%		33.8%	33.8%		33.8%	33.8%	
Maximum Green (s)	38.5	38.5		38.4	38.4		17.1	17.1		17.1	17.1	
Yellow Time (s)	3.1	3.1		3.1	3.1		3.2	3.2		3.2	3.2	
All-Red Time (s)	1.4	1.4		1.5	1.5		1.7	1.7		1.7	1.7	
Lost Time Adjust (s)		0.5			0.4			0.1			0.1	
Total Lost Time (s)		5.0			5.0			5.0			5.0	
Lead/Lag												
Lead-Lag Optimize?												
Vehicle Extension (s)	3.0	3.0		3.0	3.0		3.0	3.0		3.0	3.0	
Recall Mode	C-Max	C-Max		C-Max	C-Max		None	None		None	None	
Walk Time (s)	4.0	4.0		4.0	4.0		4.0	4.0		4.0	4.0	
Flash Dont Walk (s)	5.0	5.0		6.0	6.0		10.0	10.0		10.0	10.0	
Pedestrian Calls (#/hr)	0	0		0	0		0	0		0	0	
Act Effct Green (s)		46.8			46.8			11.6			11.6	
Actuated g/C Ratio		0.72			0.72			0.18			0.18	
v/c Ratio		0.33			0.38			0.56			0.35	
Control Delay		6.1			2.4			31.8			26.0	

Lanes, Volumes, Timings
 1: Church Street & W. Rosemary Street

09/01/2020



Lane Group	EBL	EBT	EBR	WBL	WBT	WBR	NBL	NBT	NBR	SBL	SBT	SBR
Queue Delay		0.0			0.0			0.0			0.0	
Total Delay		6.1			2.4			31.8			26.0	
LOS		A			A			C			C	
Approach Delay		6.1			2.4			31.8			26.0	
Approach LOS		A			A			C			C	
Queue Length 50th (ft)		58			19			49			32	
Queue Length 95th (ft)		124			45			66			43	
Internal Link Dist (ft)		884			677			299			350	
Turn Bay Length (ft)												
Base Capacity (vph)		1223			1176			349			373	
Starvation Cap Reductn		0			0			0			0	
Spillback Cap Reductn		0			0			0			0	
Storage Cap Reductn		0			0			0			0	
Reduced v/c Ratio		0.33			0.38			0.38			0.24	

Intersection Summary

Area Type:	CBD
Cycle Length:	65
Actuated Cycle Length:	65
Offset:	23 (35%), Referenced to phase 2:EBTL and 6:WBTL, Start of Green
Natural Cycle:	40
Control Type:	Actuated-Coordinated
Maximum v/c Ratio:	0.56
Intersection Signal Delay:	9.4
Intersection LOS:	A
Intersection Capacity Utilization	70.4%
ICU Level of Service	C
Analysis Period (min)	15

Splits and Phases: 1: Church Street & W. Rosemary Street



Lanes, Volumes, Timings

2: NC 86 (N. Columbia St) & W. Rosemary Street/E. Rosemary Street

09/01/2020



Lane Group	EBL	EBT	EBR	WBL	WBT	WBR	NBL	NBT	NBR	SBL	SBT	SBR
Lane Configurations												
Traffic Volume (vph)	155	202	48	60	215	38	44	315	127	48	356	178
Future Volume (vph)	155	202	48	60	215	38	44	315	127	48	356	178
Ideal Flow (vphpl)	1900	1900	1900	1900	1900	1900	1900	1900	1900	1900	1900	1900
Lane Width (ft)	9	12	13	12	12	12	9	10	12	12	9	11
Grade (%)		1%			1%			-2%			8%	
Storage Length (ft)	100		0	150		0	75		0	150		400
Storage Lanes	1		0	1		0	1		0	1		1
Taper Length (ft)	25			25			25			25		
Lane Util. Factor	1.00	1.00	1.00	1.00	1.00	1.00	1.00	0.95	0.95	1.00	0.95	1.00
Ped Bike Factor	0.97	0.99		0.96	0.99		0.85	0.85		0.80		0.66
Frt		0.971			0.977			0.957				0.850
Flt Protected	0.950			0.950			0.950			0.950		
Satd. Flow (prot)	1426	1596	0	1585	1608	0	1355	2299	0	1485	2673	1285
Flt Permitted	0.288			0.585			0.443			0.428		
Satd. Flow (perm)	418	1596	0	934	1608	0	539	2299	0	532	2673	850
Right Turn on Red			No			No			No			No
Satd. Flow (RTOR)												
Link Speed (mph)		20			20			25			25	
Link Distance (ft)		757			456			353			476	
Travel Time (s)		25.8			15.5			9.6			13.0	
Confl. Peds. (#/hr)	53		41	41		53	80		129	129		80
Peak Hour Factor	0.88	0.88	0.88	0.85	0.85	0.85	0.98	0.98	0.98	0.86	0.86	0.86
Heavy Vehicles (%)	2%	2%	2%	2%	2%	2%	9%	9%	9%	5%	5%	5%
Adj. Flow (vph)	176	230	55	71	253	45	45	321	130	56	414	207
Shared Lane Traffic (%)												
Lane Group Flow (vph)	176	285	0	71	298	0	45	451	0	56	414	207
Turn Type	pm+pt	NA		Perm	NA		pm+pt	NA		pm+pt	NA	pm+ov
Protected Phases	7	4			8		5	2		1	6	7
Permitted Phases	4			8			2			6		6
Detector Phase	7	4		8	8		5	2		1	6	7
Switch Phase												
Minimum Initial (s)	7.0	7.0		7.0	7.0		7.0	10.0		7.0	10.0	7.0
Minimum Split (s)	13.0	31.0		32.0	32.0		13.0	23.0		13.0	22.0	13.0
Total Split (s)	43.0	63.0		20.0	20.0		15.0	52.0		15.0	52.0	43.0
Total Split (%)	33.1%	48.5%		15.4%	15.4%		11.5%	40.0%		11.5%	40.0%	33.1%
Maximum Green (s)	37.2	57.0		14.0	14.0		9.2	46.2		9.9	46.2	37.2
Yellow Time (s)	3.0	3.2		3.2	3.2		3.0	3.3		3.0	3.3	3.0
All-Red Time (s)	2.8	2.8		2.8	2.8		2.8	2.5		2.1	2.5	2.8
Lost Time Adjust (s)	-0.8	-1.0		-1.0	-1.0		0.0	-0.8		-0.1	-0.8	-0.8
Total Lost Time (s)	5.0	5.0		5.0	5.0		5.8	5.0		5.0	5.0	5.0
Lead/Lag	Lead			Lag	Lag		Lead	Lag		Lead	Lag	Lead
Lead-Lag Optimize?												
Vehicle Extension (s)	1.0	1.0		1.0	1.0		1.0	3.0		1.0	3.0	1.0
Recall Mode	None	None		None	None		None	C-Max		None	C-Max	None
Walk Time (s)		7.0		7.0	7.0			7.0			7.0	
Flash Dont Walk (s)		18.0		19.0	19.0			10.0			9.0	
Pedestrian Calls (#/hr)		0		0	0			0			0	
Act Effect Green (s)	58.0	58.0		33.4	33.4		57.0	51.9		57.6	51.5	71.1

Lanes, Volumes, Timings

2: NC 86 (N. Columbia St) & W. Rosemary Street/E. Rosemary Street

09/01/2020



Lane Group	EBL	EBT	EBR	WBL	WBT	WBR	NBL	NBT	NBR	SBL	SBT	SBR
Actuated g/C Ratio	0.45	0.45		0.26	0.26		0.44	0.40		0.44	0.40	0.55
v/c Ratio	0.52	0.40		0.30	0.72		0.16	0.49		0.19	0.39	0.39
Control Delay	29.3	27.4		42.5	53.1		16.4	19.2		14.7	19.8	9.3
Queue Delay	0.0	0.0		0.0	0.0		0.0	0.5		0.0	0.0	0.0
Total Delay	29.3	27.4		42.5	53.1		16.4	19.7		14.7	19.8	9.3
LOS	C	C		D	D		B	B		B	B	A
Approach Delay		28.1			51.1			19.4			16.2	
Approach LOS		C			D			B			B	
Queue Length 50th (ft)	92	184		42	216		10	55		14	75	41
Queue Length 95th (ft)	122	232		92	#378		m27	112		25	91	30
Internal Link Dist (ft)		677			376			273			396	
Turn Bay Length (ft)	100			150			75			150		400
Base Capacity (vph)	481	712		239	413		300	918		316	1058	712
Starvation Cap Reductn	0	0		0	0		0	163		0	0	0
Spillback Cap Reductn	0	0		0	0		0	0		0	0	0
Storage Cap Reductn	0	0		0	0		0	0		0	0	0
Reduced v/c Ratio	0.37	0.40		0.30	0.72		0.15	0.60		0.18	0.39	0.29

Intersection Summary

Area Type: CBD
 Cycle Length: 130
 Actuated Cycle Length: 130
 Offset: 55 (42%), Referenced to phase 2:NBTL and 6:SBTL, Start of Green
 Natural Cycle: 85
 Control Type: Actuated-Coordinated
 Maximum v/c Ratio: 0.72
 Intersection Signal Delay: 26.1 Intersection LOS: C
 Intersection Capacity Utilization 68.8% ICU Level of Service C
 Analysis Period (min) 15
 # 95th percentile volume exceeds capacity, queue may be longer.
 Queue shown is maximum after two cycles.
 m Volume for 95th percentile queue is metered by upstream signal.

Splits and Phases: 2: NC 86 (N. Columbia St) & W. Rosemary Street/E. Rosemary Street

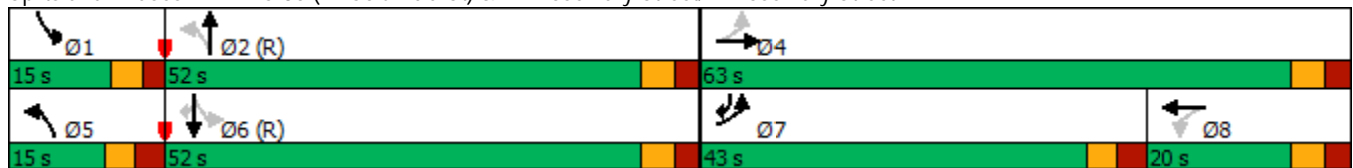

Lanes, Volumes, Timings
6: Henderson Street & E. Rosemary Street

09/01/2020



Lane Group	EBL	EBT	EBR	WBL	WBT	WBR	NBL	NBT	NBR	SBL	SBT	SBR
Lane Configurations												
Traffic Volume (vph)	15	190	122	15	204	31	55	30	11	9	38	13
Future Volume (vph)	15	190	122	15	204	31	55	30	11	9	38	13
Ideal Flow (vphpl)	1900	1900	1900	1900	1900	1900	1900	1900	1900	1900	1900	1900
Grade (%)		0%			0%			0%				3%
Storage Length (ft)	85		0	0		0	0		0	0		0
Storage Lanes	1		0	0		0	0		0	0		0
Taper Length (ft)	25			25			25			25		
Lane Util. Factor	1.00	1.00	1.00	1.00	1.00	1.00	1.00	1.00	1.00	1.00	1.00	1.00
Ped Bike Factor	0.96	0.97			0.99			0.85				0.93
Frt		0.941			0.983			0.985				0.971
Flt Protected	0.950				0.997			0.972				0.992
Satd. Flow (prot)	1593	1531	0	0	1626	0	0	1580	0	0	1497	0
Flt Permitted	0.596				0.977			0.783				0.940
Satd. Flow (perm)	961	1531	0	0	1591	0	0	1098	0	0	1398	0
Right Turn on Red			No			No			No			No
Satd. Flow (RTOR)												
Link Speed (mph)		20			20			20				20
Link Distance (ft)		500			1195			366				450
Travel Time (s)		17.0			40.7			12.5				15.3
Confl. Peds. (#/hr)	21		19	19		21	106		47	47		106
Peak Hour Factor	0.96	0.96	0.96	0.95	0.95	0.95	0.68	0.68	0.68	0.85	0.85	0.85
Adj. Flow (vph)	16	198	127	16	215	33	81	44	16	11	45	15
Shared Lane Traffic (%)												
Lane Group Flow (vph)	16	325	0	0	264	0	0	141	0	0	71	0
Turn Type	Perm	NA		Perm	NA		Perm	NA		Perm	NA	
Protected Phases		2			2			4				4
Permitted Phases	2			2			4			4		
Detector Phase	2	2		2	2		4	4		4		4
Switch Phase												
Minimum Initial (s)	11.0	11.0		11.0	11.0		8.0	8.0		8.0		8.0
Minimum Split (s)	15.9	15.9		15.9	15.9		17.8	17.8		17.8		17.8
Total Split (s)	38.0	38.0		38.0	38.0		27.0	27.0		27.0		27.0
Total Split (%)	58.5%	58.5%		58.5%	58.5%		41.5%	41.5%		41.5%		41.5%
Maximum Green (s)	33.1	33.1		33.1	33.1		22.2	22.2		22.2		22.2
Yellow Time (s)	3.3	3.3		3.3	3.3		3.3	3.3		3.3		3.3
All-Red Time (s)	1.6	1.6		1.6	1.6		1.5	1.5		1.5		1.5
Lost Time Adjust (s)	0.1	0.1			0.1			0.2				0.2
Total Lost Time (s)	5.0	5.0			5.0			5.0				5.0
Lead/Lag												
Lead-Lag Optimize?												
Vehicle Extension (s)	2.0	2.0		2.0	2.0		2.0	2.0		2.0		2.0
Recall Mode	C-Max	C-Max		C-Max	C-Max		None	None		None		None
Walk Time (s)	4.0	4.0		4.0	4.0		4.0	4.0		4.0		4.0
Flash Dont Walk (s)	7.0	7.0		7.0	7.0		9.0	9.0		9.0		9.0
Pedestrian Calls (#/hr)	0	0		0	0		0	0		0		0
Act Effct Green (s)	45.9	45.9			45.9			12.7				12.7
Actuated g/C Ratio	0.71	0.71			0.71			0.20				0.20
v/c Ratio	0.02	0.30			0.24			0.66				0.26

Lanes, Volumes, Timings
 6: Henderson Street & E. Rosemary Street

09/01/2020



Lane Group	EBL	EBT	EBR	WBL	WBT	WBR	NBL	NBT	NBR	SBL	SBT	SBR
Control Delay	6.1	5.9			6.1			35.4			22.8	
Queue Delay	0.0	0.0			0.0			0.0			0.0	
Total Delay	6.1	5.9			6.1			35.4			22.8	
LOS	A	A			A			D			C	
Approach Delay		5.9			6.1			35.4			22.8	
Approach LOS		A			A			D			C	
Queue Length 50th (ft)	2	47			57			62			24	
Queue Length 95th (ft)	m9	113			106			66			46	
Internal Link Dist (ft)		420			1115			286			370	
Turn Bay Length (ft)	85											
Base Capacity (vph)	678	1080			1122			371			473	
Starvation Cap Reductn	0	0			0			0			0	
Spillback Cap Reductn	0	0			0			0			0	
Storage Cap Reductn	0	0			0			0			0	
Reduced v/c Ratio	0.02	0.30			0.24			0.38			0.15	

Intersection Summary

Area Type: CBD
 Cycle Length: 65
 Actuated Cycle Length: 65
 Offset: 63 (97%), Referenced to phase 2:EBWB, Start of Green
 Natural Cycle: 40
 Control Type: Actuated-Coordinated
 Maximum v/c Ratio: 0.66
 Intersection Signal Delay: 12.5
 Intersection LOS: B
 Intersection Capacity Utilization 49.5%
 ICU Level of Service A
 Analysis Period (min) 15
 m Volume for 95th percentile queue is metered by upstream signal.

Splits and Phases: 6: Henderson Street & E. Rosemary Street



Lanes, Volumes, Timings

7: Hillsborough Street & E. Rosemary Street

09/01/2020



Lane Group	EBL	EBT	EBR	WBL	WBT	WBR	NBL	NBT	NBR	SBL	SBT	SBR
Lane Configurations		↕			↕		↕	↕		↕	↕	
Traffic Volume (vph)	23	90	85	3	51	9	162	179	9	16	218	25
Future Volume (vph)	23	90	85	3	51	9	162	179	9	16	218	25
Ideal Flow (vphp)	1900	1900	1900	1900	1900	1900	1900	1900	1900	1900	1900	1900
Storage Length (ft)	0		0	0		0	100		0	100		0
Storage Lanes	0		0	0		0	1		0	1		0
Taper Length (ft)	25			25			25			25		
Lane Util. Factor	1.00	1.00	1.00	1.00	1.00	1.00	1.00	1.00	1.00	1.00	1.00	1.00
Ped Bike Factor		0.95			0.98		0.93	1.00		0.99	0.98	
Frt		0.942			0.980			0.993			0.985	
Flt Protected		0.994			0.998		0.950			0.950		
Satd. Flow (prot)	0	1674	0	0	1791	0	1770	1847	0	1719	1750	0
Flt Permitted		0.956			0.982		0.489			0.625		
Satd. Flow (perm)	0	1594	0	0	1758	0	846	1847	0	1117	1750	0
Right Turn on Red			No			No			No			No
Satd. Flow (RTOR)												
Link Speed (mph)		20			20			25			25	
Link Distance (ft)		1195			527			363			726	
Travel Time (s)		40.7			18.0			9.9			19.8	
Confl. Peds. (#/hr)	35		35	35		35	50		5	5		50
Peak Hour Factor	0.93	0.93	0.93	0.78	0.78	0.78	0.88	0.88	0.88	0.91	0.91	0.91
Heavy Vehicles (%)	2%	2%	2%	2%	2%	2%	2%	2%	2%	5%	5%	5%
Adj. Flow (vph)	25	97	91	4	65	12	184	203	10	18	240	27
Shared Lane Traffic (%)												
Lane Group Flow (vph)	0	213	0	0	81	0	184	213	0	18	267	0
Turn Type	Perm	NA		Perm	NA		pm+pt	NA		Perm	NA	
Protected Phases		4			8		5	2			6	
Permitted Phases	4			8			2			6		
Detector Phase	4	4		8	8		5	2		6	6	
Switch Phase												
Minimum Initial (s)	7.0	7.0		7.0	7.0		7.0	10.0		10.0	10.0	
Minimum Split (s)	20.0	20.0		17.0	17.0		12.0	15.0		15.0	15.0	
Total Split (s)	24.0	24.0		24.0	24.0		13.0	41.0		28.0	28.0	
Total Split (%)	36.9%	36.9%		36.9%	36.9%		20.0%	63.1%		43.1%	43.1%	
Maximum Green (s)	19.1	19.1		19.0	19.0		8.2	36.2		23.2	23.2	
Yellow Time (s)	3.0	3.0		3.3	3.3		3.0	3.3		3.1	3.1	
All-Red Time (s)	1.9	1.9		1.7	1.7		1.8	1.5		1.7	1.7	
Lost Time Adjust (s)		0.1			0.0		0.2	0.2		0.2	0.2	
Total Lost Time (s)		5.0			5.0		5.0	5.0		5.0	5.0	
Lead/Lag							Lead			Lag	Lag	
Lead-Lag Optimize?												
Vehicle Extension (s)	2.0	2.0		2.0	2.0		2.0	2.0		2.0	2.0	
Recall Mode	None	None		None	None		None	C-Max		C-Max	C-Max	
Walk Time (s)	4.0	4.0		4.0	4.0			4.0		4.0	4.0	
Flash Dont Walk (s)	11.0	11.0		8.0	8.0			6.0		6.0	6.0	
Pedestrian Calls (#/hr)	0	0		0	0			0		0	0	
Act Effct Green (s)		12.8			12.8		42.2	42.2		29.7	29.7	
Actuated g/C Ratio		0.20			0.20		0.65	0.65		0.46	0.46	
v/c Ratio		0.68			0.23		0.28	0.18		0.04	0.33	

Lanes, Volumes, Timings
 7: Hillsborough Street & E. Rosemary Street

09/01/2020



Lane Group	EBL	EBT	EBR	WBL	WBT	WBR	NBL	NBT	NBR	SBL	SBT	SBR
Control Delay		33.4			21.9		6.3	5.7		12.8	14.4	
Queue Delay		0.0			0.0		0.0	0.0		0.0	0.0	
Total Delay		33.4			21.9		6.3	5.7		12.8	14.4	
LOS		C			C		A	A		B	B	
Approach Delay		33.4			21.9			6.0			14.3	
Approach LOS		C			C			A			B	
Queue Length 50th (ft)		80			27		49	57		4	63	
Queue Length 95th (ft)		110			46		70	82		17	138	
Internal Link Dist (ft)		1115			447			283			646	
Turn Bay Length (ft)							100			100		
Base Capacity (vph)		465			513		665	1198		510	799	
Starvation Cap Reductn		0			0		0	0		0	0	
Spillback Cap Reductn		0			0		0	0		0	0	
Storage Cap Reductn		0			0		0	0		0	0	
Reduced v/c Ratio		0.46			0.16		0.28	0.18		0.04	0.33	

Intersection Summary

Area Type: Other
 Cycle Length: 65
 Actuated Cycle Length: 65
 Offset: 19 (29%), Referenced to phase 2:NBTL and 6:SBTL, Start of Green
 Natural Cycle: 50
 Control Type: Actuated-Coordinated
 Maximum v/c Ratio: 0.68
 Intersection Signal Delay: 15.7
 Intersection LOS: B
 Intersection Capacity Utilization 54.1%
 ICU Level of Service A
 Analysis Period (min) 15

Splits and Phases: 7: Hillsborough Street & E. Rosemary Street

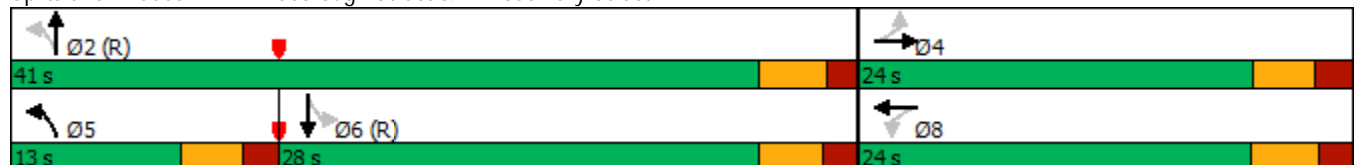

Lanes, Volumes, Timings

8: Carolina Square Driveway/Church Street & W. Franklin Street

09/01/2020



Lane Group	EBL	EBT	EBR	WBL	WBT	WBR	NBL	NBT	NBR	SBL	SBT	SBR
Lane Configurations												
Traffic Volume (vph)	52	360	26	32	331	68	10	10	22	23	23	57
Future Volume (vph)	52	360	26	32	331	68	10	10	22	23	23	57
Ideal Flow (vphpl)	1900	1900	1900	1900	1900	1900	1900	1900	1900	1900	1900	1900
Lane Width (ft)	10	10	16	10	10	10	12	12	12	12	12	12
Grade (%)		2%			-2%			-4%				-3%
Storage Length (ft)	150		0	200		0	0		100	0		0
Storage Lanes	1		0	1		0	0		1	0		0
Taper Length (ft)	25			25			25			25		
Lane Util. Factor	1.00	1.00	1.00	1.00	1.00	1.00	1.00	1.00	1.00	1.00	1.00	1.00
Ped Bike Factor	0.84	0.97		0.78	0.93			0.86	0.87		0.78	
Frt		0.990			0.974				0.850		0.925	
Flt Protected	0.950			0.950				0.976			0.989	
Satd. Flow (prot)	1443	1452	0	1472	1410	0	0	1669	1454	0	1209	0
Flt Permitted	0.481			0.477				0.827			0.925	
Satd. Flow (perm)	616	1452	0	578	1410	0	0	1219	1262	0	1103	0
Right Turn on Red			No			No			No			No
Satd. Flow (RTOR)												
Link Speed (mph)		20			20			20			25	
Link Distance (ft)		993			298			285			379	
Travel Time (s)		33.9			10.2			9.7			10.3	
Confl. Peds. (#/hr)	150		248	248		150	225		77	77		225
Peak Hour Factor	0.87	0.87	0.87	0.91	0.91	0.91	0.81	0.81	0.81	0.71	0.71	0.71
Heavy Vehicles (%)	4%	4%	4%	4%	4%	4%	2%	2%	2%	5%	5%	5%
Adj. Flow (vph)	60	414	30	35	364	75	12	12	27	32	32	80
Shared Lane Traffic (%)												
Lane Group Flow (vph)	60	444	0	35	439	0	0	24	27	0	144	0
Turn Type	Perm	NA		Perm	NA		Perm	NA	Perm	Perm	NA	
Protected Phases		2			6			8				4
Permitted Phases	2			6			8		8	4		
Detector Phase	2	2		6	6		8	8	8	4	4	
Switch Phase												
Minimum Initial (s)	10.0	10.0		10.0	10.0		7.0	7.0	7.0	7.0	7.0	
Minimum Split (s)	22.0	22.0		19.0	19.0		29.0	29.0	29.0	27.0	27.0	
Total Split (s)	36.0	36.0		36.0	36.0		29.0	29.0	29.0	29.0	29.0	
Total Split (%)	55.4%	55.4%		55.4%	55.4%		44.6%	44.6%	44.6%	44.6%	44.6%	
Maximum Green (s)	30.4	30.4		30.4	30.4		22.7	22.7	22.7	23.0	23.0	
Yellow Time (s)	3.3	3.3		3.3	3.3		3.1	3.1	3.1	3.4	3.4	
All-Red Time (s)	2.3	2.3		2.3	2.3		3.2	3.2	3.2	2.6	2.6	
Lost Time Adjust (s)	-0.6	-0.6		-0.6	-0.6		-1.3	-1.3	-1.3	-1.0	-1.0	
Total Lost Time (s)	5.0	5.0		5.0	5.0		5.0	5.0	5.0	5.0	5.0	
Lead/Lag												
Lead-Lag Optimize?												
Vehicle Extension (s)	3.0	3.0		3.0	3.0		2.0	2.0	2.0	2.0	2.0	
Recall Mode	C-Max	C-Max		C-Max	C-Max		None	None	None	None	None	
Walk Time (s)	7.0	7.0		7.0	7.0		7.0	7.0	7.0	7.0	7.0	
Flash Dont Walk (s)	9.0	9.0		6.0	6.0		15.0	15.0	15.0	14.0	14.0	
Pedestrian Calls (#/hr)	0	0		0	0		0	0	0	0	0	
Act Effect Green (s)	44.7	44.7		44.7	44.7		14.0	14.0	14.0	14.0	13.9	

Lanes, Volumes, Timings

8: Carolina Square Driveway/Church Street & W. Franklin Street

09/01/2020



Lane Group	EBL	EBT	EBR	WBL	WBT	WBR	NBL	NBT	NBR	SBL	SBT	SBR
Actuated g/C Ratio	0.69	0.69		0.69	0.69			0.22	0.22		0.21	
v/c Ratio	0.14	0.44		0.09	0.45			0.09	0.10		0.61	
Control Delay	7.6	9.1		8.1	10.1			18.6	18.8		32.3	
Queue Delay	0.0	0.0		0.0	0.0			0.0	0.0		0.0	
Total Delay	7.6	9.1		8.1	10.1			18.6	18.8		32.3	
LOS	A	A		A	B			B	B		C	
Approach Delay		8.9			10.0			18.7			32.3	
Approach LOS		A			A			B			C	
Queue Length 50th (ft)	8	79		3	49			8	9		61	
Queue Length 95th (ft)	29	178		m27	322			19	21		62	
Internal Link Dist (ft)		913			218			205			299	
Turn Bay Length (ft)	150			200					100			
Base Capacity (vph)	423	998		397	969			450	465		407	
Starvation Cap Reductn	0	0		0	0			0	0		0	
Spillback Cap Reductn	0	0		0	0			0	0		0	
Storage Cap Reductn	0	0		0	0			0	0		0	
Reduced v/c Ratio	0.14	0.44		0.09	0.45			0.05	0.06		0.35	

Intersection Summary

Area Type: CBD
 Cycle Length: 65
 Actuated Cycle Length: 65
 Offset: 2 (3%), Referenced to phase 2:EBTL and 6:WBTL, Start of Green
 Natural Cycle: 60
 Control Type: Actuated-Coordinated
 Maximum v/c Ratio: 0.61
 Intersection Signal Delay: 12.6 Intersection LOS: B
 Intersection Capacity Utilization 70.8% ICU Level of Service C
 Analysis Period (min) 15
 m Volume for 95th percentile queue is metered by upstream signal.

Splits and Phases: 8: Carolina Square Driveway/Church Street & W. Franklin Street

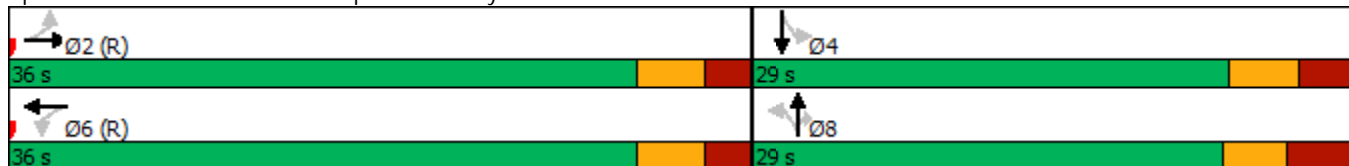

Lanes, Volumes, Timings

9: NC 86 (S. Columbia St)/NC 86 (N. Columbia St) & W. Franklin Street/E. Franklin Street 09/01/2020



Lane Group	EBL	EBT	EBR	WBL	WBT	WBR	NBL	NBT	NBR	SBL	SBT	SBR
Lane Configurations												
Traffic Volume (vph)	104	298	46	82	308	87	61	303	90	50	318	89
Future Volume (vph)	104	298	46	82	308	87	61	303	90	50	318	89
Ideal Flow (vphpl)	1900	1900	1900	1900	1900	1900	1900	1900	1900	1900	1900	1900
Lane Width (ft)	9	12	13	10	10	13	9	10	10	9	9	11
Grade (%)		3%			1%			-2%			3%	
Storage Length (ft)	250		0	125		0	475		0	125		0
Storage Lanes	1		0	1		1	1		0	1		0
Taper Length (ft)	25			25			25			25		
Lane Util. Factor	1.00	0.95	0.95	1.00	1.00	1.00	1.00	0.95	0.95	1.00	0.95	0.95
Ped Bike Factor	0.80	0.96		0.82		0.67	0.82	0.92		0.80	0.92	
Frt		0.980				0.850		0.966			0.967	
Flt Protected	0.950			0.950			0.950			0.950		
Satd. Flow (prot)	1372	2853	0	1437	1512	1423	1342	2468	0	1346	2398	0
Flt Permitted	0.950			0.950			0.950			0.950		
Satd. Flow (perm)	1096	2853	0	1178	1512	947	1104	2468	0	1081	2398	0
Right Turn on Red			No			No			No			No
Satd. Flow (RTOR)												
Link Speed (mph)		20			20			25			25	
Link Distance (ft)		457			941			981			353	
Travel Time (s)		15.6			32.1			26.8			9.6	
Confl. Peds. (#/hr)	251		248	248		251	117		321	321		117
Peak Hour Factor	0.80	0.80	0.80	0.87	0.87	0.87	0.93	0.93	0.93	0.85	0.85	0.85
Heavy Vehicles (%)	5%	5%	5%	5%	5%	5%	10%	10%	10%	7%	7%	7%
Adj. Flow (vph)	130	373	58	94	354	100	66	326	97	59	374	105
Shared Lane Traffic (%)												
Lane Group Flow (vph)	130	431	0	94	354	100	66	423	0	59	479	0
Turn Type	Prot	NA		Prot	NA	pm+ov	Prot	NA		Prot	NA	
Protected Phases	5	2		1	6	7	3	8		7	4	
Permitted Phases						6						
Detector Phase	5	2		1	6	7	3	8		7	4	
Switch Phase												
Minimum Initial (s)	7.0	10.0		7.0	10.0	7.0	7.0	7.0		7.0	7.0	
Minimum Split (s)	15.0	28.2		15.0	28.2	15.0	15.0	28.0		15.0	28.1	
Total Split (s)	25.0	32.0		25.0	32.0	25.0	25.0	48.0		25.0	48.0	
Total Split (%)	19.2%	24.6%		19.2%	24.6%	19.2%	19.2%	36.9%		19.2%	36.9%	
Maximum Green (s)	19.6	25.8		19.1	25.8	19.1	19.1	42.1		19.1	42.3	
Yellow Time (s)	3.0	3.0		3.0	3.0	3.0	3.0	3.3		3.0	3.1	
All-Red Time (s)	2.4	3.2		2.9	3.2	2.9	2.9	2.6		2.9	2.6	
Lost Time Adjust (s)	-0.4	-1.2		-0.9	-1.2	-2.0	-0.9	-0.9		-0.9	-0.7	
Total Lost Time (s)	5.0	5.0		5.0	5.0	3.9	5.0	5.0		5.0	5.0	
Lead/Lag	Lead	Lag		Lead	Lag	Lead	Lead	Lag		Lead	Lag	
Lead-Lag Optimize?												
Vehicle Extension (s)	1.0	3.0		1.0	3.0	1.0	1.0	2.0		1.0	2.0	
Recall Mode	None	C-Max		None	C-Max	None	None	Ped		None	Ped	
Walk Time (s)		7.0			7.0			7.0			7.0	
Flash Dont Walk (s)		15.0			15.0			15.0			15.0	
Pedestrian Calls (#/hr)		0			0			0			0	
Act Effect Green (s)	16.1	54.5		13.0	51.4	64.2	11.2	31.9		10.6	33.9	

Lanes, Volumes, Timings

9: NC 86 (S. Columbia St)/NC 86 (N. Columbia St) & W. Franklin Street/E. Franklin Street 09/01/2020



Lane Group	EBL	EBT	EBR	WBL	WBT	WBR	NBL	NBT	NBR	SBL	SBT	SBR
Actuated g/C Ratio	0.12	0.42		0.10	0.40	0.49	0.09	0.25		0.08	0.26	
v/c Ratio	0.77	0.36		0.66	0.59	0.20	0.57	0.70		0.54	0.77	
Control Delay	76.0	32.4		83.8	39.3	13.7	100.2	28.9		89.6	35.2	
Queue Delay	0.0	0.0		0.0	0.0	0.0	0.0	0.0		0.0	0.1	
Total Delay	76.0	32.4		83.8	39.3	13.7	100.2	28.9		89.6	35.3	
LOS	E	C		F	D	B	F	C		F	D	
Approach Delay		42.5			42.3			38.5			41.2	
Approach LOS		D			D			D			D	
Queue Length 50th (ft)	103	128		72	242	31	57	70		52	91	
Queue Length 95th (ft)	139	212		137	#481	70	105	66		94	113	
Internal Link Dist (ft)		377			861			901			273	
Turn Bay Length (ft)	250			125			475			125		
Base Capacity (vph)	218	1196		221	597	613	206	816		207	793	
Starvation Cap Reductn	0	0		0	0	0	0	0		0	13	
Spillback Cap Reductn	0	0		0	0	0	0	0		0	0	
Storage Cap Reductn	0	0		0	0	0	0	0		0	0	
Reduced v/c Ratio	0.60	0.36		0.43	0.59	0.16	0.32	0.52		0.29	0.61	

Intersection Summary

Area Type: CBD
 Cycle Length: 130
 Actuated Cycle Length: 130
 Offset: 0 (0%), Referenced to phase 2:EBT and 6:WBT, Start of Green
 Natural Cycle: 90
 Control Type: Actuated-Coordinated
 Maximum v/c Ratio: 0.77
 Intersection Signal Delay: 41.2 Intersection LOS: D
 Intersection Capacity Utilization 65.6% ICU Level of Service C
 Analysis Period (min) 15
 # 95th percentile volume exceeds capacity, queue may be longer.
 Queue shown is maximum after two cycles.

Splits and Phases: 9: NC 86 (S. Columbia St)/NC 86 (N. Columbia St) & W. Franklin Street/E. Franklin Street

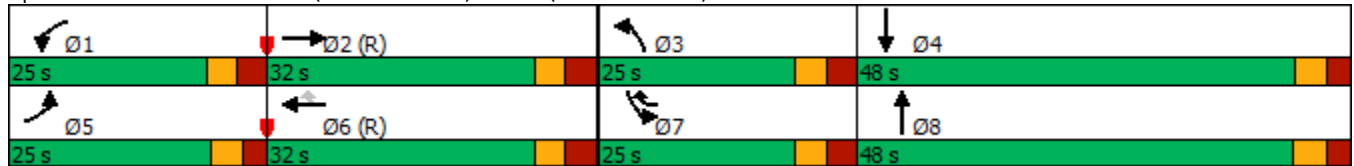

Lanes, Volumes, Timings
 10: E. Franklin Street & Henderson Street

09/01/2020



Lane Group	EBL	EBT	WBT	WBR	SBL	SBR
Lane Configurations		↑↑	↑↑		↑↑	
Traffic Volume (vph)	47	377	415	54	96	80
Future Volume (vph)	47	377	415	54	96	80
Ideal Flow (vphpl)	1900	1900	1900	1900	1900	1900
Lane Width (ft)	10	13	10	10	11	11
Grade (%)		-2%	2%		3%	
Lane Util. Factor	0.95	0.95	0.95	0.95	1.00	1.00
Ped Bike Factor		0.99	0.97		0.79	
Frt			0.983		0.939	
Flt Protected		0.995			0.973	
Satd. Flow (prot)	0	3213	2748	0	1245	0
Flt Permitted		0.862			0.973	
Satd. Flow (perm)	0	2747	2748	0	1154	0
Right Turn on Red				No		No
Satd. Flow (RTOR)						
Link Speed (mph)		20	20		20	
Link Distance (ft)		941	1200		366	
Travel Time (s)		32.1	40.9		12.5	
Confl. Peds. (#/hr)	119			119	130	370
Peak Hour Factor	0.95	0.95	0.92	0.92	0.87	0.87
Heavy Vehicles (%)	5%	5%	4%	4%	2%	2%
Parking (#/hr)						0
Adj. Flow (vph)	49	397	451	59	110	92
Shared Lane Traffic (%)						
Lane Group Flow (vph)	0	446	510	0	202	0
Turn Type	Perm	NA	NA		Prot	
Protected Phases		2	6		4	
Permitted Phases	2					
Detector Phase	2	2	6		4	
Switch Phase						
Minimum Initial (s)	10.0	10.0	10.0		7.0	
Minimum Split (s)	17.0	17.0	22.0		25.0	
Total Split (s)	32.0	32.0	32.0		33.0	
Total Split (%)	49.2%	49.2%	49.2%		50.8%	
Maximum Green (s)	25.8	25.8	25.9		27.9	
Yellow Time (s)	3.0	3.0	3.0		3.0	
All-Red Time (s)	3.2	3.2	3.1		2.1	
Lost Time Adjust (s)		-1.2	-1.1		-0.1	
Total Lost Time (s)		5.0	5.0		5.0	
Lead/Lag						
Lead-Lag Optimize?						
Vehicle Extension (s)	2.0	2.0	2.0		1.0	
Recall Mode	C-Max	C-Max	C-Max		None	
Walk Time (s)			7.0		7.0	
Flash Dont Walk (s)			8.0		12.0	
Pedestrian Calls (#/hr)			0		0	
Act Effct Green (s)		40.5	40.5		14.5	
Actuated g/C Ratio		0.62	0.62		0.22	
v/c Ratio		0.26	0.30		0.73	

Lanes, Volumes, Timings
 10: E. Franklin Street & Henderson Street

09/01/2020

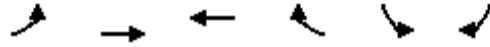

Lane Group	EBL	EBT	WBT	WBR	SBL	SBR
Control Delay		6.6	7.5		36.1	
Queue Delay		0.0	0.0		0.0	
Total Delay		6.6	7.5		36.1	
LOS		A	A		D	
Approach Delay		6.6	7.5		36.1	
Approach LOS		A	A		D	
Queue Length 50th (ft)		14	36		92	
Queue Length 95th (ft)		154	132		124	
Internal Link Dist (ft)		861	1120		286	
Turn Bay Length (ft)						
Base Capacity (vph)		1711	1712		536	
Starvation Cap Reductn		0	0		0	
Spillback Cap Reductn		0	0		0	
Storage Cap Reductn		0	0		0	
Reduced v/c Ratio		0.26	0.30		0.38	

Intersection Summary

Area Type:	CBD
Cycle Length:	65
Actuated Cycle Length:	65
Offset:	4 (6%), Referenced to phase 2:EBTL and 6:WBT, Start of Green
Natural Cycle:	50
Control Type:	Actuated-Coordinated
Maximum v/c Ratio:	0.73
Intersection Signal Delay:	12.1
Intersection LOS:	B
Intersection Capacity Utilization	56.8%
ICU Level of Service	B
Analysis Period (min)	15

Splits and Phases: 10: E. Franklin Street & Henderson Street

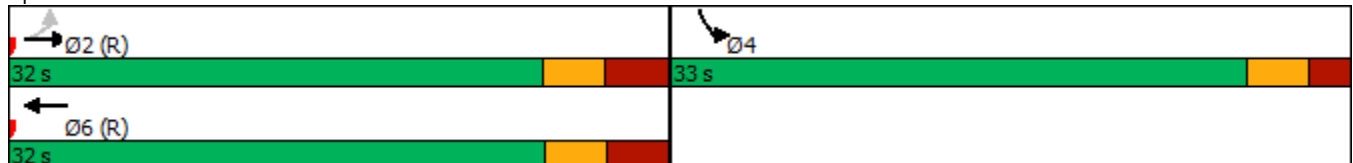

Lanes, Volumes, Timings

11: Raleigh Street/Hillsborough Street & E. Franklin Street

09/01/2020



Lane Group	EBL	EBT	EBR	WBL	WBT	WBR	NBL	NBT	NBR	SBL	SBT	SBR
Lane Configurations												
Traffic Volume (vph)	55	331	148	41	370	144	83	160	23	69	194	23
Future Volume (vph)	55	331	148	41	370	144	83	160	23	69	194	23
Ideal Flow (vphpl)	1900	1900	1900	1900	1900	1900	1900	1900	1900	1900	1900	1900
Lane Width (ft)	9	9	10	9	10	11	12	12	12	10	10	10
Grade (%)		1%			-2%			1%			1%	
Storage Length (ft)	75		0	75		0	0		0	100		0
Storage Lanes	1		0	1		0	0		0	1		0
Taper Length (ft)	25			25			25			25		
Lane Util. Factor	1.00	0.95	0.95	1.00	0.95	0.95	1.00	1.00	1.00	1.00	1.00	1.00
Ped Bike Factor	0.98	0.98		0.99	0.98			0.97		0.97	0.98	
Frt		0.954			0.958			0.989			0.984	
Flt Protected	0.950			0.950				0.985		0.950		
Satd. Flow (prot)	1539	2893	0	1593	3096	0	0	1795	0	1612	1638	0
Flt Permitted	0.413			0.433				0.663		0.494		
Satd. Flow (perm)	653	2893	0	717	3096	0	0	1179	0	813	1638	0
Right Turn on Red			No			No			No			No
Satd. Flow (RTOR)												
Link Speed (mph)		20			30			25			25	
Link Distance (ft)		1200			1013			995			363	
Travel Time (s)		40.9			23.0			27.1			9.9	
Confl. Peds. (#/hr)	50		25	25		50	93		33	33		93
Peak Hour Factor	0.91	0.91	0.91	0.91	0.91	0.91	0.94	0.94	0.94	0.90	0.90	0.90
Heavy Vehicles (%)	5%	5%	5%	3%	3%	3%	2%	2%	2%	4%	4%	4%
Adj. Flow (vph)	60	364	163	45	407	158	88	170	24	77	216	26
Shared Lane Traffic (%)												
Lane Group Flow (vph)	60	527	0	45	565	0	0	282	0	77	242	0
Turn Type	Perm	NA		Perm	NA		pm+pt	NA		D.Pm	NA	
Protected Phases		2			6		7	4				8
Permitted Phases	2			6			4			4		
Detector Phase	2	2		6	6		7	4		4		8
Switch Phase												
Minimum Initial (s)	10.0	10.0		10.0	10.0		7.0	7.0		7.0	7.0	
Minimum Split (s)	16.0	16.0		16.0	16.0		14.0	30.0		30.0	29.0	
Total Split (s)	60.0	60.0		60.0	60.0		31.0	70.0		70.0	39.0	
Total Split (%)	46.2%	46.2%		46.2%	46.2%		23.8%	53.8%		53.8%	30.0%	
Maximum Green (s)	54.7	54.7		54.7	54.7		24.8	63.6		63.6	32.6	
Yellow Time (s)	3.0	3.0		3.0	3.0		3.0	3.1		3.1	3.1	
All-Red Time (s)	2.3	2.3		2.3	2.3		3.2	3.3		3.3	3.3	
Lost Time Adjust (s)	-0.3	-0.3		-0.3	-0.3			-1.4		-1.4	-1.4	
Total Lost Time (s)	5.0	5.0		5.0	5.0			5.0		5.0	5.0	
Lead/Lag							Lead				Lag	
Lead-Lag Optimize?												
Vehicle Extension (s)	3.0	3.0		3.0	3.0		3.0	2.0		2.0	2.0	
Recall Mode	C-Max	C-Max		C-Max	C-Max		None	None		None	None	
Walk Time (s)								7.0		7.0	7.0	
Flash Dont Walk (s)								16.0		16.0	15.0	
Pedestrian Calls (#/hr)								0		0	0	
Act Effect Green (s)	80.0	80.0		80.0	80.0			40.0		40.0	40.0	

Lanes, Volumes, Timings

11: Raleigh Street/Hillsborough Street & E. Franklin Street

09/01/2020



Lane Group	EBL	EBT	EBR	WBL	WBT	WBR	NBL	NBT	NBR	SBL	SBT	SBR
Actuated g/C Ratio	0.62	0.62		0.62	0.62			0.31		0.31	0.31	
v/c Ratio	0.15	0.30		0.10	0.30			0.78		0.31	0.48	
Control Delay	13.2	11.1		14.3	13.8			54.7		34.3	38.7	
Queue Delay	0.0	0.0		0.0	0.0			0.0		0.0	4.4	
Total Delay	13.2	11.1		14.3	13.8			54.7		34.3	43.0	
LOS	B	B		B	B			D		C	D	
Approach Delay		11.3			13.8			54.7			40.9	
Approach LOS		B			B			D			D	
Queue Length 50th (ft)	12	59		15	111			216		48	164	
Queue Length 95th (ft)	51	155		43	189			278		80	209	
Internal Link Dist (ft)		1120			933			915			283	
Turn Bay Length (ft)	75			75						100		
Base Capacity (vph)	402	1780		441	1905			589		406	524	
Starvation Cap Reductn	0	0		0	0			0		0	207	
Spillback Cap Reductn	0	0		0	0			0		0	0	
Storage Cap Reductn	0	0		0	0			0		0	0	
Reduced v/c Ratio	0.15	0.30		0.10	0.30			0.48		0.19	0.76	

Intersection Summary





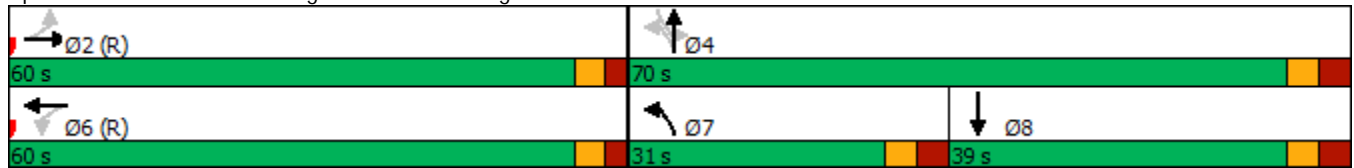













Area Type:	Other
Cycle Length:	130
Actuated Cycle Length:	130
Offset:	57 (44%), Referenced to phase 2:EBTL and 6:WBTL, Start of Green
Natural Cycle:	60
Control Type:	Actuated-Coordinated
Maximum v/c Ratio:	0.78
Intersection Signal Delay:	24.2
Intersection LOS:	C
Intersection Capacity Utilization	76.7%
ICU Level of Service	D
Analysis Period (min)	15

Splits and Phases: 11: Raleigh Street/Hillsborough Street & E. Franklin Street



Lanes, Volumes, Timings

13: NC 86 (N. Columbia St)/NC 86 (MLK Jr. Blvd) & North Street & N. Columbia Street 09/01/2020

												
Lane Group	WBL	WBR	WBR2	NBL	NBT	NBR	SBL	SBT	SBR	SEL2	SEL	SER
Lane Configurations												
Traffic Volume (vph)	8	9	84	44	454	4	62	515	6	1	7	59
Future Volume (vph)	8	9	84	44	454	4	62	515	6	1	7	59
Ideal Flow (vphpl)	1900	1900	1900	1900	1900	1900	1900	1900	1900	1900	1900	1900
Grade (%)	2%				-5%			5%				-3%
Storage Length (ft)	0	0		150		0	70		0		0	0
Storage Lanes	1	0		1		0	1		0		1	0
Taper Length (ft)	25			25			25				25	
Lane Util. Factor	1.00	1.00	1.00	1.00	0.95	0.95	1.00	0.95	0.95	1.00	1.00	1.00
Ped Bike Factor	0.98			1.00	1.00		0.98	1.00			1.00	
Frt	0.876				0.999			0.998				0.880
Flt Protected	0.996			0.950			0.950				0.994	
Satd. Flow (prot)	1578	0	0	1729	3453	0	1676	3344	0	0	1562	0
Flt Permitted	0.996			0.398			0.454				0.994	
Satd. Flow (perm)	1578	0	0	722	3453	0	783	3344	0	0	1560	0
Right Turn on Red			No			No			No			No
Satd. Flow (RTOR)												
Link Speed (mph)	20				35			35				25
Link Distance (ft)	264				476			2108				715
Travel Time (s)	9.0				9.3			41.1				19.5
Confl. Peds. (#/hr)			8	6		41	41		6	8		
Peak Hour Factor	0.75	0.75	0.75	0.93	0.93	0.93	0.87	0.87	0.87	0.75	0.75	0.75
Heavy Vehicles (%)	2%	2%	2%	7%	7%	7%	5%	5%	5%	8%	8%	8%
Adj. Flow (vph)	11	12	112	47	488	4	71	592	7	1	9	79
Shared Lane Traffic (%)												
Lane Group Flow (vph)	135	0	0	47	492	0	71	599	0	0	89	0
Turn Type	Prot			Perm	NA		Perm	NA		Prot	Prot	
Protected Phases	3				2			6		4	4	
Permitted Phases				2			6					
Detector Phase	3			2	2		6	6		4	4	
Switch Phase												
Minimum Initial (s)	7.0			10.0	10.0		10.0	10.0		7.0	7.0	
Minimum Split (s)	14.0			17.0	17.0		17.0	17.0		14.0	14.0	
Total Split (s)	39.0			61.0	61.0		61.0	61.0		30.0	30.0	
Total Split (%)	30.0%			46.9%	46.9%		46.9%	46.9%		23.1%	23.1%	
Maximum Green (s)	32.0			54.0	54.0		54.0	54.0		23.0	23.0	
Yellow Time (s)	5.0			5.0	5.0		5.0	5.0		5.0	5.0	
All-Red Time (s)	2.0			2.0	2.0		2.0	2.0		2.0	2.0	
Lost Time Adjust (s)	-2.0			-2.0	-2.0		-2.0	-2.0			-2.0	
Total Lost Time (s)	5.0			5.0	5.0		5.0	5.0			5.0	
Lead/Lag	Lead									Lag	Lag	
Lead-Lag Optimize?	Yes									Yes	Yes	
Vehicle Extension (s)	3.0			3.0	3.0		3.0	3.0		3.0	3.0	
Recall Mode	None			C-Max	C-Max		C-Max	C-Max		None	None	
Act Effct Green (s)	18.5			81.8	81.8		81.8	81.8			14.7	
Actuated g/C Ratio	0.14			0.63	0.63		0.63	0.63			0.11	
v/c Ratio	0.60			0.10	0.23		0.14	0.28			0.50	
Control Delay	63.0			8.5	7.2		13.0	12.4			63.2	
Queue Delay	0.0			0.0	0.0		0.0	0.0			0.0	

Lanes, Volumes, Timings

13: NC 86 (N. Columbia St)/NC 86 (MLK Jr. Blvd) & North Street & N. Columbia Street 09/01/2020



Lane Group	WBL	WBR	WBR2	NBL	NBT	NBR	SBL	SBT	SBR	SEL2	SEL	SER
Total Delay	63.0			8.5	7.2		13.0	12.4			63.2	
LOS	E			A	A		B	B			E	
Approach Delay	63.0				7.3			12.5			63.2	
Approach LOS	E				A			B			E	
Queue Length 50th (ft)	108			8	44		23	112			72	
Queue Length 95th (ft)	137			m22	77		56	176			101	
Internal Link Dist (ft)	184				396			2028			635	
Turn Bay Length (ft)				150			70					
Base Capacity (vph)	412			454	2172		492	2104			300	
Starvation Cap Reductn	0			0	0		0	0			0	
Spillback Cap Reductn	0			0	0		0	0			0	
Storage Cap Reductn	0			0	0		0	0			0	
Reduced v/c Ratio	0.33			0.10	0.23		0.14	0.28			0.30	

Intersection Summary

Area Type:	Other
Cycle Length:	130
Actuated Cycle Length:	130
Offset:	71 (55%), Referenced to phase 2:NBTL and 6:SBTL, Start of Green
Natural Cycle:	45
Control Type:	Actuated-Coordinated
Maximum v/c Ratio:	0.60
Intersection Signal Delay:	18.4
Intersection LOS:	B
Intersection Capacity Utilization:	52.2%
ICU Level of Service:	A
Analysis Period (min):	15
m Volume for 95th percentile queue is metered by upstream signal.	

Splits and Phases: 13: NC 86 (N. Columbia St)/NC 86 (MLK Jr. Blvd) & North Street & N. Columbia Street

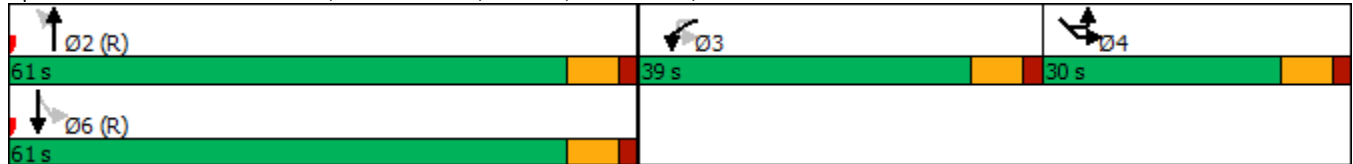

Lanes, Volumes, Timings

14: NC 86 (MLK Jr. Blvd) & Longview Street/Mill Creek Apts Driveway

09/01/2020



Lane Group	EBL	EBT	EBR	WBL	WBT	WBR	NBL	NBT	NBR	SBL	SBT	SBR
Lane Configurations		↕			↕		↕	↕		↕	↕	
Traffic Volume (vph)	37	0	19	4	0	2	7	509	8	1	559	35
Future Volume (vph)	37	0	19	4	0	2	7	509	8	1	559	35
Ideal Flow (vphpl)	1900	1900	1900	1900	1900	1900	1900	1900	1900	1900	1900	1900
Grade (%)		-6%			1%			2%			-4%	
Storage Length (ft)	0		0	0		0	225		0	250		0
Storage Lanes	0		0	0		0	1		0	1		0
Taper Length (ft)	25			25			25			25		
Lane Util. Factor	1.00	1.00	1.00	1.00	1.00	1.00	1.00	0.95	0.95	1.00	0.95	0.95
Ped Bike Factor		0.99			0.98		0.99	1.00		0.98	1.00	
Frt		0.954			0.955			0.998			0.991	
Flt Protected		0.968			0.968		0.950			0.950		
Satd. Flow (prot)	0	1720	0	0	1706	0	1670	3330	0	1753	3468	0
Flt Permitted		0.794			0.754		0.404			0.433		
Satd. Flow (perm)	0	1410	0	0	1314	0	705	3330	0	786	3468	0
Right Turn on Red			No			No			No			No
Satd. Flow (RTOR)												
Link Speed (mph)		25			20			35			35	
Link Distance (ft)		451			338			2108			784	
Travel Time (s)		12.3			11.5			41.1			15.3	
Confl. Peds. (#/hr)	1		19	19		1	7		15	15		7
Peak Hour Factor	0.76	0.76	0.76	0.50	0.50	0.50	0.89	0.89	0.89	0.91	0.91	0.91
Heavy Vehicles (%)	4%	4%	4%	2%	2%	2%	7%	7%	7%	5%	5%	5%
Adj. Flow (vph)	49	0	25	8	0	4	8	572	9	1	614	38
Shared Lane Traffic (%)												
Lane Group Flow (vph)	0	74	0	0	12	0	8	581	0	1	652	0
Turn Type	Perm	NA		Perm	NA		Perm	NA		Perm	NA	
Protected Phases		4			8			2			6	
Permitted Phases	4			8			2			6		
Detector Phase	4	4		8	8		2	2		6	6	
Switch Phase												
Minimum Initial (s)	7.0	7.0		7.0	7.0		12.0	12.0		12.0	12.0	
Minimum Split (s)	31.0	31.0		14.0	14.0		28.0	28.0		28.0	28.0	
Total Split (s)	20.0	20.0		20.0	20.0		60.0	60.0		60.0	60.0	
Total Split (%)	25.0%	25.0%		25.0%	25.0%		75.0%	75.0%		75.0%	75.0%	
Maximum Green (s)	14.0	14.0		13.9	13.9		54.0	54.0		54.5	54.5	
Yellow Time (s)	3.5	3.5		3.0	3.0		4.5	4.5		4.0	4.0	
All-Red Time (s)	2.5	2.5		3.1	3.1		1.5	1.5		1.5	1.5	
Lost Time Adjust (s)		-1.0			-1.0		-1.0	-1.0		-0.5	-0.5	
Total Lost Time (s)		5.0			5.1		5.0	5.0		5.0	5.0	
Lead/Lag												
Lead-Lag Optimize?												
Vehicle Extension (s)	3.0	3.0		3.0	3.0		3.0	3.0		3.0	3.0	
Recall Mode	None	None		None	None		Min	Min		Min	Min	
Walk Time (s)	7.0	7.0					7.0	7.0		7.0	7.0	
Flash Dont Walk (s)	17.0	17.0					9.0	9.0		9.0	9.0	
Pedestrian Calls (#/hr)	0	0					0	0		0	0	
Act Effct Green (s)		8.7			8.6		24.4	24.4		24.4	24.4	
Actuated g/C Ratio		0.25			0.24		0.69	0.69		0.69	0.69	

Lanes, Volumes, Timings

14: NC 86 (MLK Jr. Blvd) & Longview Street/Mill Creek Apts Driveway

09/01/2020



Lane Group	EBL	EBT	EBR	WBL	WBT	WBR	NBL	NBT	NBR	SBL	SBT	SBR
v/c Ratio		0.21			0.04		0.02	0.25		0.00	0.27	
Control Delay		12.7			10.8		5.4	5.1		5.0	5.1	
Queue Delay		0.0			0.0		0.0	0.0		0.0	0.0	
Total Delay		12.7			10.8		5.4	5.1		5.0	5.1	
LOS		B			B		A	A		A	A	
Approach Delay		12.7			10.8			5.1			5.1	
Approach LOS		B			B			A			A	
Queue Length 50th (ft)		14			2		1	32		0	36	
Queue Length 95th (ft)		27			5		5	59		2	67	
Internal Link Dist (ft)		371			258			2028			704	
Turn Bay Length (ft)							225			250		
Base Capacity (vph)		600			555		705	3330		786	3468	
Starvation Cap Reductn		0			0		0	0		0	0	
Spillback Cap Reductn		0			0		0	0		0	0	
Storage Cap Reductn		0			0		0	0		0	0	
Reduced v/c Ratio		0.12			0.02		0.01	0.17		0.00	0.19	

Intersection Summary

Area Type:	Other
Cycle Length:	80
Actuated Cycle Length:	35.4
Natural Cycle:	60
Control Type:	Actuated-Uncoordinated
Maximum v/c Ratio:	0.27
Intersection Signal Delay:	5.6
Intersection LOS:	A
Intersection Capacity Utilization:	37.4%
ICU Level of Service:	A
Analysis Period (min):	15

Splits and Phases: 14: NC 86 (MLK Jr. Blvd) & Longview Street/Mill Creek Apts Driveway



Lanes, Volumes, Timings
 15: NC 86 (Pittsboro St) & W. Cameron Avenue

09/01/2020



Lane Group	EBT	EBR	WBL	WBT	NBL	NBR	Ø1	Ø4
Lane Configurations	↻		↻↻	↻				
Traffic Volume (vph)	78	152	450	215	0	0		
Future Volume (vph)	78	152	450	215	0	0		
Ideal Flow (vphpl)	1900	1900	1900	1900	1900	1900		
Lane Width (ft)	12	12	11	12	12	12		
Grade (%)	3%			-3%	0%			
Storage Length (ft)		0	75		0	0		
Storage Lanes		0	0		0	0		
Taper Length (ft)			25		25			
Lane Util. Factor	1.00	1.00	0.97	1.00	1.00	1.00		
Ped Bike Factor	0.78		0.65					
Frt	0.911							
Flt Protected			0.950					
Satd. Flow (prot)	1170	0	2837	1592	0	0		
Flt Permitted			0.950					
Satd. Flow (perm)	1170	0	1838	1592	0	0		
Right Turn on Red		No				No		
Satd. Flow (RTOR)								
Link Speed (mph)	25			25	25			
Link Distance (ft)	391			120	794			
Travel Time (s)	30.0			10.7	21.7			
Confl. Peds. (#/hr)		129	129					
Peak Hour Factor	0.71	0.71	0.93	0.93	0.90	0.90		
Heavy Vehicles (%)	2%	2%	9%	9%	2%	2%		
Adj. Flow (vph)	110	214	484	231	0	0		
Shared Lane Traffic (%)								
Lane Group Flow (vph)	324	0	484	231	0	0		
Turn Type	NA		Prot	NA				
Protected Phases	2		1 4	6			1	4
Permitted Phases								
Detector Phase	2		1 4	6				
Switch Phase								
Minimum Initial (s)	10.0			10.0			7.0	7.0
Minimum Split (s)	20.0			20.0			20.0	20.0
Total Split (s)	77.0			110.0			33.0	20.0
Total Split (%)	59.2%			84.6%			25%	15%
Maximum Green (s)	71.9			105.0			27.9	16.0
Yellow Time (s)	3.0			3.3			3.0	3.0
All-Red Time (s)	2.1			1.7			2.1	1.0
Lost Time Adjust (s)	-0.1			0.0				
Total Lost Time (s)	5.0			5.0				
Lead/Lag	Lag						Lead	
Lead-Lag Optimize?								
Vehicle Extension (s)	1.0			1.0			4.0	0.2
Recall Mode	None			C-Max			C-Max	None
Walk Time (s)	7.0							7.0
Flash Dont Walk (s)	4.0							9.0
Pedestrian Calls (#/hr)	0							0
Act Effect Green (s)	72.0		48.0	105.5				

Lanes, Volumes, Timings
 15: NC 86 (Pittsboro St) & W. Cameron Avenue

09/01/2020



Lane Group	EBT	EBR	WBL	WBT	NBL	NBR	Ø1	Ø4
Actuated g/C Ratio	0.55		0.37	0.81				
v/c Ratio	0.50		0.46	0.18				
Control Delay	21.3		26.2	3.2				
Queue Delay	0.0		1.2	0.5				
Total Delay	21.3		27.3	3.8				
LOS	C		C	A				
Approach Delay	21.3			19.7				
Approach LOS	C			B				
Queue Length 50th (ft)	162		161	29				
Queue Length 95th (ft)	174		243	m65				
Internal Link Dist (ft)	311			40	714			
Turn Bay Length (ft)			75					
Base Capacity (vph)	648		1035	1291				
Starvation Cap Reductn	0		325	720				
Spillback Cap Reductn	0		0	0				
Storage Cap Reductn	0		0	0				
Reduced v/c Ratio	0.50		0.68	0.40				

Intersection Summary

Area Type: CBD
 Cycle Length: 130
 Actuated Cycle Length: 130
 Offset: 28 (22%), Referenced to phase 1:WBL and 6:WBT, Start of Green
 Natural Cycle: 60
 Control Type: Actuated-Coordinated
 Maximum v/c Ratio: 0.50
 Intersection Signal Delay: 20.2 Intersection LOS: C
 Intersection Capacity Utilization 42.0% ICU Level of Service A
 Analysis Period (min) 15
 m Volume for 95th percentile queue is metered by upstream signal.

Splits and Phases: 15: NC 86 (Pittsboro St) & W. Cameron Avenue

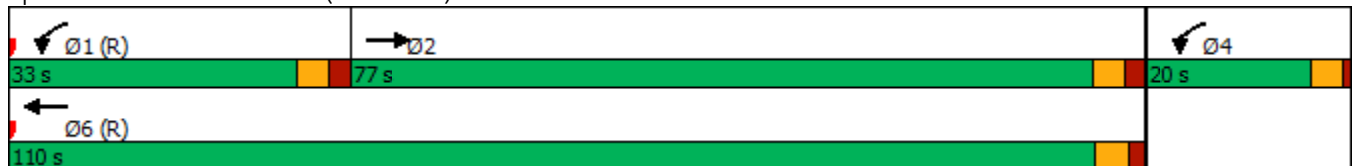

Lanes, Volumes, Timings

16: NC 86 (S. Columbia St) & W. Cameron Avenue/E. Cameron Avenue

09/01/2020



Lane Group	EBL	EBT	EBR	WBL	WBT	WBR	NBL	NBT	NBR	SBL	SBT	SBR
Lane Configurations												
Traffic Volume (vph)	20	51	0	0	90	37	169	384	27	43	0	405
Future Volume (vph)	20	51	0	0	90	37	169	384	27	43	0	405
Ideal Flow (vphpl)	1900	1900	1900	1900	1900	1900	1900	1900	1900	1900	1900	1900
Lane Width (ft)	11	12	12	12	12	12	10	10	10	11	11	12
Grade (%)		1%			-1%			1%			2%	
Storage Length (ft)	100		0	0		0	0		0	310		0
Storage Lanes	1		0	0		0	1		0	1		2
Taper Length (ft)	25			25			25			25		
Lane Util. Factor	1.00	1.00	1.00	1.00	1.00	1.00	0.91	0.91	0.95	1.00	1.00	0.88
Ped Bike Factor	0.77				0.91		0.60	0.94		0.61		0.43
Frt					0.961			0.991				0.850
Flt Protected	0.950						0.950	0.998		0.950		
Satd. Flow (prot)	1488	1620	0	0	1403	0	1259	2495	0	1439	0	2345
Flt Permitted	0.489						0.950	0.998		0.950		
Satd. Flow (perm)	590	1620	0	0	1403	0	757	2455	0	879	0	1014
Right Turn on Red			No			No			No			No
Satd. Flow (RTOR)												
Link Speed (mph)		25			25			25				25
Link Distance (ft)		273			989			826				981
Travel Time (s)		10.7			57.6			22.5				26.8
Confl. Peds. (#/hr)	207		358	358		207	244		349	349		244
Peak Hour Factor	0.93	0.93	0.93	0.84	0.84	0.84	0.86	0.86	0.86	0.86	0.86	0.86
Heavy Vehicles (%)	5%	5%	5%	7%	7%	7%	9%	9%	9%	8%	8%	8%
Adj. Flow (vph)	22	55	0	0	107	44	197	447	31	50	0	471
Shared Lane Traffic (%)							10%					
Lane Group Flow (vph)	22	55	0	0	151	0	177	498	0	50	0	471
Turn Type	Perm	NA			NA		Split	NA		Prot		Prot
Protected Phases		4			8		2	2		1		1
Permitted Phases	4									1		1
Detector Phase	4	4			8		2	2		1		1
Switch Phase												
Minimum Initial (s)	10.0	10.0			10.0		7.0	7.0		7.0		7.0
Minimum Split (s)	24.0	24.0			31.0		18.0	18.0		26.0		26.0
Total Split (s)	40.0	40.0			40.0		23.0	23.0		39.0		39.0
Total Split (%)	30.8%	30.8%			30.8%		17.7%	17.7%		30.0%		30.0%
Maximum Green (s)	33.8	33.8			33.8		17.1	17.1		33.4		33.4
Yellow Time (s)	3.2	3.2			3.2		3.1	3.1		3.0		3.0
All-Red Time (s)	3.0	3.0			3.0		2.8	2.8		2.6		2.6
Lost Time Adjust (s)	-1.2	-1.2			-1.2		-0.9	-0.9		-0.6		-0.6
Total Lost Time (s)	5.0	5.0			5.0		5.0	5.0		5.0		5.0
Lead/Lag							Lead	Lead		Lag		Lag
Lead-Lag Optimize?												
Vehicle Extension (s)	2.0	2.0			2.0		4.0	4.0		4.0		4.0
Recall Mode	None	None			None		C-Max	C-Max		None		None
Walk Time (s)	7.0	7.0			7.0		7.0	7.0		7.0		7.0
Flash Dont Walk (s)	10.0	10.0			17.0		5.0	5.0		13.0		13.0
Pedestrian Calls (#/hr)	0	0			0		0	0		0		0
Act Effect Green (s)	19.6	19.6			19.6		64.3	64.3		31.1		31.1

Lanes, Volumes, Timings

16: NC 86 (S. Columbia St) & W. Cameron Avenue/E. Cameron Avenue

09/01/2020

Lane Group	Ø9
Lane Configurations	
Traffic Volume (vph)	
Future Volume (vph)	
Ideal Flow (vphpl)	
Lane Width (ft)	
Grade (%)	
Storage Length (ft)	
Storage Lanes	
Taper Length (ft)	
Lane Util. Factor	
Ped Bike Factor	
Frt	
Flt Protected	
Satd. Flow (prot)	
Flt Permitted	
Satd. Flow (perm)	
Right Turn on Red	
Satd. Flow (RTOR)	
Link Speed (mph)	
Link Distance (ft)	
Travel Time (s)	
Confl. Peds. (#/hr)	
Peak Hour Factor	
Heavy Vehicles (%)	
Adj. Flow (vph)	
Shared Lane Traffic (%)	
Lane Group Flow (vph)	
Turn Type	
Protected Phases	9
Permitted Phases	
Detector Phase	
Switch Phase	
Minimum Initial (s)	7.0
Minimum Split (s)	28.0
Total Split (s)	28.0
Total Split (%)	22%
Maximum Green (s)	24.0
Yellow Time (s)	3.0
All-Red Time (s)	1.0
Lost Time Adjust (s)	
Total Lost Time (s)	
Lead/Lag	
Lead-Lag Optimize?	
Vehicle Extension (s)	0.2
Recall Mode	None
Walk Time (s)	7.0
Flash Dont Walk (s)	17.0
Pedestrian Calls (#/hr)	0
Act Effect Green (s)	

Lanes, Volumes, Timings

16: NC 86 (S. Columbia St) & W. Cameron Avenue/E. Cameron Avenue

09/01/2020

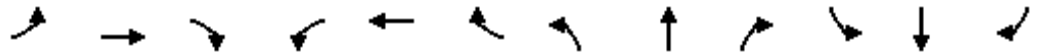

Lane Group	EBL	EBT	EBR	WBL	WBT	WBR	NBL	NBT	NBR	SBL	SBT	SBR
Actuated g/C Ratio	0.15	0.15			0.15		0.49	0.49		0.24		0.24
v/c Ratio	0.25	0.23			0.71		0.28	0.40		0.15		0.84
Control Delay	38.0	33.6			70.0		23.3	23.7		19.0		36.4
Queue Delay	0.0	0.0			0.0		0.0	0.0		0.0		0.0
Total Delay	38.0	33.6			70.0		23.3	23.7		19.0		36.4
LOS	D	C			E		C	C		B		D
Approach Delay		34.9			70.0			23.6				34.7
Approach LOS		C			E			C				C
Queue Length 50th (ft)	17	42			123		97	147		18		197
Queue Length 95th (ft)	m35	84			171		168	209		m35		257
Internal Link Dist (ft)		193			909			746				901
Turn Bay Length (ft)	100									310		
Base Capacity (vph)	158	436			377		622	1233		376		613
Starvation Cap Reductn	0	0			0		0	0		0		0
Spillback Cap Reductn	0	0			0		0	0		0		0
Storage Cap Reductn	0	0			0		0	0		0		0
Reduced v/c Ratio	0.14	0.13			0.40		0.28	0.40		0.13		0.77

Intersection Summary

Area Type: CBD
 Cycle Length: 130
 Actuated Cycle Length: 130
 Offset: 67 (52%), Referenced to phase 2:NBTL, Start of Green
 Natural Cycle: 105
 Control Type: Actuated-Coordinated
 Maximum v/c Ratio: 0.84
 Intersection Signal Delay: 33.2 Intersection LOS: C
 Intersection Capacity Utilization 69.0% ICU Level of Service C
 Analysis Period (min) 15
 m Volume for 95th percentile queue is metered by upstream signal.

Splits and Phases: 16: NC 86 (S. Columbia St) & W. Cameron Avenue/E. Cameron Avenue

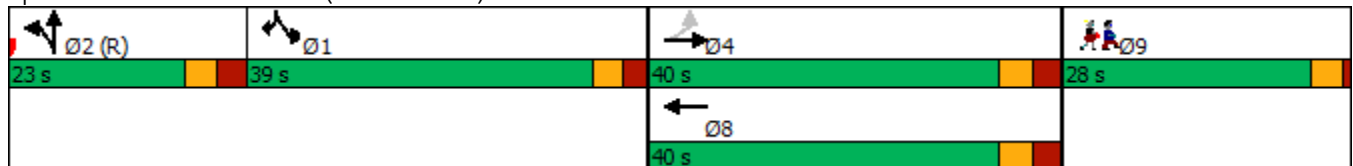

Lanes, Volumes, Timings

16: NC 86 (S. Columbia St) & W. Cameron Avenue/E. Cameron Avenue

09/01/2020

Lane Group	Ø9
Actuated g/C Ratio	
v/c Ratio	
Control Delay	
Queue Delay	
Total Delay	
LOS	
Approach Delay	
Approach LOS	
Queue Length 50th (ft)	
Queue Length 95th (ft)	
Internal Link Dist (ft)	
Turn Bay Length (ft)	
Base Capacity (vph)	
Starvation Cap Reductn	
Spillback Cap Reductn	
Storage Cap Reductn	
Reduced v/c Ratio	
Intersection Summary	

Lanes, Volumes, Timings

17: Raleigh Street & E. Cameron Avenue/Country Club Road

09/01/2020



Lane Group	EBL	EBT	EBR	WBL	WBT	WBR	NBL	NBT	NBR	SBL	SBT	SBR
Lane Configurations		↕		↗	↘		↗	↘		↗	↘	
Traffic Volume (vph)	31	64	33	21	86	165	33	76	28	233	111	44
Future Volume (vph)	31	64	33	21	86	165	33	76	28	233	111	44
Ideal Flow (vphpl)	1900	1900	1900	1900	1900	1900	1900	1900	1900	1900	1900	1900
Grade (%)		-3%			3%			-2%				1%
Storage Length (ft)	0		0	150		0	125		0	75		0
Storage Lanes	0		0	1		0	1		0	1		0
Taper Length (ft)	25			25			25			25		
Lane Util. Factor	1.00	1.00	1.00	1.00	1.00	1.00	1.00	1.00	1.00	1.00	1.00	1.00
Ped Bike Factor		0.91		0.90	0.87		0.67	0.95		0.87	0.85	
Frt		0.965			0.902			0.960			0.958	
Flt Protected		0.988		0.950			0.950			0.950		
Satd. Flow (prot)	0	1514	0	1569	1295	0	1505	1450	0	1554	1329	0
Flt Permitted		0.845		0.537			0.654			0.453		
Satd. Flow (perm)	0	1256	0	796	1295	0	697	1450	0	646	1329	0
Right Turn on Red			No			No			No			No
Satd. Flow (RTOR)												
Link Speed (mph)		25			25			25				25
Link Distance (ft)		598			651			409				995
Travel Time (s)		16.3			17.8			11.2				27.1
Confl. Peds. (#/hr)	38		43	43		38	103		33	33		103
Peak Hour Factor	0.87	0.87	0.87	0.91	0.91	0.91	0.93	0.93	0.93	0.95	0.95	0.95
Heavy Vehicles (%)	2%	2%	2%	2%	2%	2%	9%	9%	9%	4%	4%	4%
Adj. Flow (vph)	36	74	38	23	95	181	35	82	30	245	117	46
Shared Lane Traffic (%)												
Lane Group Flow (vph)	0	148	0	23	276	0	35	112	0	245	163	0
Turn Type	Perm	NA		pm+pt	NA		pm+pt	NA		pm+pt	NA	
Protected Phases		2		1	6		3	8		7	4	
Permitted Phases	2			6			8			4		
Detector Phase	2	2		1	6		3	8		7	4	
Switch Phase												
Minimum Initial (s)	10.0	10.0		7.0	10.0		7.0	7.0		7.0	7.0	
Minimum Split (s)	18.0	18.0		13.0	19.0		13.0	19.0		12.0	16.0	
Total Split (s)	50.0	50.0		20.0	70.0		20.0	35.0		20.0	35.0	
Total Split (%)	40.0%	40.0%		16.0%	56.0%		16.0%	28.0%		16.0%	28.0%	
Maximum Green (s)	43.9	43.9		14.4	64.4		14.7	29.7		15.1	29.9	
Yellow Time (s)	3.3	3.3		3.0	3.1		3.0	3.1		3.0	3.1	
All-Red Time (s)	2.8	2.8		2.6	2.5		2.3	2.2		1.9	2.0	
Lost Time Adjust (s)		-1.1		-0.6	-0.6		-0.3	-0.3		0.1	-0.1	
Total Lost Time (s)		5.0		5.0	5.0		5.0	5.0		5.0	5.0	
Lead/Lag	Lag	Lag		Lead			Lead	Lag		Lead	Lag	
Lead-Lag Optimize?	Yes	Yes		Yes			Yes	Yes		Yes	Yes	
Vehicle Extension (s)	2.0	2.0		2.0	2.0		2.0	2.0		2.0	2.0	
Recall Mode	None	None		None	None		None	None		None	None	
Walk Time (s)	4.0	4.0			4.0			4.0			4.0	
Flash Dont Walk (s)	7.0	7.0			9.0			9.0			6.0	
Pedestrian Calls (#/hr)	0	0			0			0			0	
Act Effect Green (s)		16.1		19.7	19.7		15.9	10.5		24.7	20.9	
Actuated g/C Ratio		0.29		0.35	0.35		0.29	0.19		0.44	0.38	

Lanes, Volumes, Timings

17: Raleigh Street & E. Cameron Avenue/Country Club Road

09/01/2020

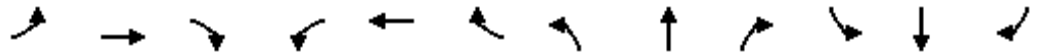

Lane Group	EBL	EBT	EBR	WBL	WBT	WBR	NBL	NBT	NBR	SBL	SBT	SBR
v/c Ratio		0.41		0.06	0.60		0.11	0.41		0.49	0.33	
Control Delay		25.4		13.7	22.5		12.5	30.0		14.8	19.0	
Queue Delay		0.0		0.0	0.0		0.0	0.0		0.0	0.0	
Total Delay		25.4		13.7	22.5		12.5	30.0		14.8	19.0	
LOS		C		B	C		B	C		B	B	
Approach Delay		25.4			21.8			25.8			16.5	
Approach LOS		C			C			C			B	
Queue Length 50th (ft)		39		5	82		5	34		42	27	
Queue Length 95th (ft)		110		19	166		25	95		127	118	
Internal Link Dist (ft)		518			571			329			915	
Turn Bay Length (ft)				150			125			75		
Base Capacity (vph)		1003		548	1236		553	868		593	796	
Starvation Cap Reductn		0		0	0		0	0		0	0	
Spillback Cap Reductn		0		0	0		0	0		0	0	
Storage Cap Reductn		0		0	0		0	0		0	0	
Reduced v/c Ratio		0.15		0.04	0.22		0.06	0.13		0.41	0.20	

Intersection Summary

Area Type: CBD
 Cycle Length: 125
 Actuated Cycle Length: 55.7
 Natural Cycle: 65
 Control Type: Actuated-Uncoordinated
 Maximum v/c Ratio: 0.60
 Intersection Signal Delay: 20.8
 Intersection LOS: C
 Intersection Capacity Utilization 68.1%
 ICU Level of Service C
 Analysis Period (min) 15

Splits and Phases: 17: Raleigh Street & E. Cameron Avenue/Country Club Road

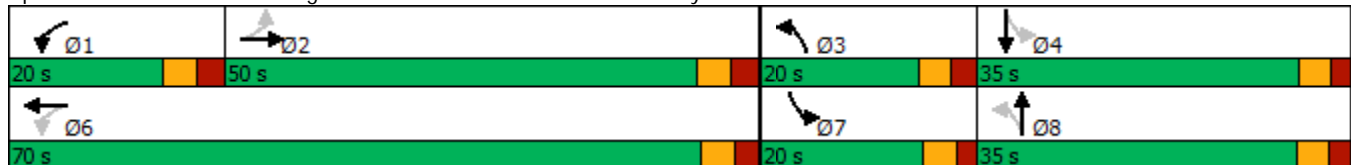

Lanes, Volumes, Timings
1: Church Street & W. Rosemary Street

09/01/2020



Lane Group	EBL	EBT	EBR	WBL	WBT	WBR	NBL	NBT	NBR	SBL	SBT	SBR
Lane Configurations		↕			↕			↕			↕	
Traffic Volume (vph)	24	422	65	59	437	37	47	79	63	24	75	26
Future Volume (vph)	24	422	65	59	437	37	47	79	63	24	75	26
Ideal Flow (vphpl)	1900	1900	1900	1900	1900	1900	1900	1900	1900	1900	1900	1900
Lane Width (ft)	12	14	12	12	14	12	12	12	12	12	12	12
Grade (%)		1%			-1%			0%			0%	
Lane Util. Factor	1.00	1.00	1.00	1.00	1.00	1.00	1.00	1.00	1.00	1.00	1.00	1.00
Ped Bike Factor		0.98			0.98			0.93			0.95	
Frt		0.983			0.991			0.955			0.972	
Flt Protected		0.998			0.994			0.988			0.990	
Satd. Flow (prot)	0	1710	0	0	1751	0	0	1516	0	0	1556	0
Flt Permitted		0.967			0.903			0.903			0.925	
Satd. Flow (perm)	0	1654	0	0	1583	0	0	1345	0	0	1435	0
Right Turn on Red			No			No			No			No
Satd. Flow (RTOR)												
Link Speed (mph)		20			20			25			25	
Link Distance (ft)		964			757			379			430	
Travel Time (s)		32.9			25.8			10.3			11.7	
Confl. Peds. (#/hr)	40		37	37		40	62		43	43		62
Peak Hour Factor	0.95	0.95	0.95	0.97	0.97	0.97	0.91	0.91	0.91	0.93	0.93	0.93
Adj. Flow (vph)	25	444	68	61	451	38	52	87	69	26	81	28
Shared Lane Traffic (%)												
Lane Group Flow (vph)	0	537	0	0	550	0	0	208	0	0	135	0
Turn Type	Perm	NA		Perm	NA		Perm	NA		Perm	NA	
Protected Phases		2			6			8			4	
Permitted Phases	2			6			8			4		
Detector Phase	2	2		6	6		8	8		4	4	
Switch Phase												
Minimum Initial (s)	10.0	10.0		10.0	10.0		7.0	7.0		7.0	7.0	
Minimum Split (s)	19.0	19.0		20.0	20.0		19.0	19.0		19.0	19.0	
Total Split (s)	45.0	45.0		45.0	45.0		25.0	25.0		25.0	25.0	
Total Split (%)	64.3%	64.3%		64.3%	64.3%		35.7%	35.7%		35.7%	35.7%	
Maximum Green (s)	40.5	40.5		40.4	40.4		20.1	20.1		20.1	20.1	
Yellow Time (s)	3.1	3.1		3.1	3.1		3.2	3.2		3.2	3.2	
All-Red Time (s)	1.4	1.4		1.5	1.5		1.7	1.7		1.7	1.7	
Lost Time Adjust (s)		0.5			0.4			0.1			0.1	
Total Lost Time (s)		5.0			5.0			5.0			5.0	
Lead/Lag												
Lead-Lag Optimize?												
Vehicle Extension (s)	3.0	3.0		3.0	3.0		3.0	3.0		3.0	3.0	
Recall Mode	C-Max	C-Max		C-Max	C-Max		None	None		None	None	
Walk Time (s)	4.0	4.0		4.0	4.0		4.0	4.0		4.0	4.0	
Flash Dont Walk (s)	5.0	5.0		6.0	6.0		10.0	10.0		10.0	10.0	
Pedestrian Calls (#/hr)	0	0		0	0		0	0		0	0	
Act Effct Green (s)		44.6			44.6			15.4			15.4	
Actuated g/C Ratio		0.64			0.64			0.22			0.22	
v/c Ratio		0.51			0.55			0.71			0.43	
Control Delay		9.9			5.6			36.8			26.6	
Queue Delay		0.0			0.0			0.0			0.0	

Lanes, Volumes, Timings
 1: Church Street & W. Rosemary Street

09/01/2020



Lane Group	EBL	EBT	EBR	WBL	WBT	WBR	NBL	NBT	NBR	SBL	SBT	SBR
Total Delay		9.9			5.6			36.8			26.6	
LOS		A			A			D			C	
Approach Delay		9.9			5.6			36.8			26.6	
Approach LOS		A			A			D			C	
Queue Length 50th (ft)		111			68			77			50	
Queue Length 95th (ft)		217			m96			m92			90	
Internal Link Dist (ft)		884			677			299			350	
Turn Bay Length (ft)												
Base Capacity (vph)		1053			1008			384			410	
Starvation Cap Reductn		0			0			0			0	
Spillback Cap Reductn		0			0			0			0	
Storage Cap Reductn		0			0			0			0	
Reduced v/c Ratio		0.51			0.55			0.54			0.33	

Intersection Summary

Area Type: CBD
 Cycle Length: 70
 Actuated Cycle Length: 70
 Offset: 25 (36%), Referenced to phase 2:EBTL and 6:WBTL, Start of Green
 Natural Cycle: 50
 Control Type: Actuated-Coordinated
 Maximum v/c Ratio: 0.71
 Intersection Signal Delay: 13.8
 Intersection LOS: B
 Intersection Capacity Utilization 79.7%
 ICU Level of Service D
 Analysis Period (min) 15
 m Volume for 95th percentile queue is metered by upstream signal.

Splits and Phases: 1: Church Street & W. Rosemary Street



Lanes, Volumes, Timings

2: NC 86 (N. Columbia St) & W. Rosemary Street/E. Rosemary Street

09/01/2020



Lane Group	EBL	EBT	EBR	WBL	WBT	WBR	NBL	NBT	NBR	SBL	SBT	SBR
Lane Configurations												
Traffic Volume (vph)	230	269	49	90	225	37	51	591	89	61	510	274
Future Volume (vph)	230	269	49	90	225	37	51	591	89	61	510	274
Ideal Flow (vphpl)	1900	1900	1900	1900	1900	1900	1900	1900	1900	1900	1900	1900
Lane Width (ft)	9	12	13	12	12	12	9	10	12	12	9	11
Grade (%)		1%			1%			-2%			8%	
Storage Length (ft)	100		0	150		0	75		0	150		400
Storage Lanes	1		0	1		0	1		0	1		1
Taper Length (ft)	25			25			25			25		
Lane Util. Factor	1.00	1.00	1.00	1.00	1.00	1.00	1.00	0.95	0.95	1.00	0.95	1.00
Ped Bike Factor	0.97	0.99		0.96	0.99		0.94	0.95				0.73
Frt		0.977			0.979			0.980				0.850
Flt Protected	0.950			0.950			0.950			0.950		
Satd. Flow (prot)	1426	1612	0	1585	1613	0	1420	2752	0	1514	2725	1310
Flt Permitted	0.189			0.545			0.347			0.257		
Satd. Flow (perm)	275	1612	0	876	1613	0	485	2752	0	410	2725	952
Right Turn on Red			No			No			No			No
Satd. Flow (RTOR)												
Link Speed (mph)		20			20			25			25	
Link Distance (ft)		757			461			353			476	
Travel Time (s)		25.8			15.7			9.6			13.0	
Confl. Peds. (#/hr)	49		36	36		49	59		83	83		59
Peak Hour Factor	0.88	0.88	0.88	0.94	0.94	0.94	0.83	0.83	0.83	0.82	0.82	0.82
Heavy Vehicles (%)	2%	2%	2%	2%	2%	2%	4%	4%	4%	3%	3%	3%
Adj. Flow (vph)	261	306	56	96	239	39	61	712	107	74	622	334
Shared Lane Traffic (%)												
Lane Group Flow (vph)	261	362	0	96	278	0	61	819	0	74	622	334
Turn Type	pm+pt	NA		Perm	NA		pm+pt	NA		pm+pt	NA	pm+ov
Protected Phases	7	4			8		5	2		1	6	7
Permitted Phases	4			8			2			6		6
Detector Phase	7	4		8	8		5	2		1	6	7
Switch Phase												
Minimum Initial (s)	7.0	7.0		7.0	7.0		7.0	10.0		7.0	10.0	7.0
Minimum Split (s)	13.0	31.0		32.0	32.0		13.0	23.0		13.0	22.0	13.0
Total Split (s)	24.0	56.0		32.0	32.0		20.0	64.0		20.0	64.0	24.0
Total Split (%)	17.1%	40.0%		22.9%	22.9%		14.3%	45.7%		14.3%	45.7%	17.1%
Maximum Green (s)	18.2	50.0		26.0	26.0		14.2	58.2		14.9	58.2	18.2
Yellow Time (s)	3.0	3.2		3.2	3.2		3.0	3.3		3.0	3.3	3.0
All-Red Time (s)	2.8	2.8		2.8	2.8		2.8	2.5		2.1	2.5	2.8
Lost Time Adjust (s)	-0.8	-1.0		-1.0	-1.0		-1.0	-0.8		-0.1	-0.8	-0.8
Total Lost Time (s)	5.0	5.0		5.0	5.0		4.8	5.0		5.0	5.0	5.0
Lead/Lag	Lead			Lag	Lag		Lead	Lag		Lead	Lag	Lead
Lead-Lag Optimize?												
Vehicle Extension (s)	1.0	1.0		1.0	1.0		1.0	3.0		1.0	3.0	1.0
Recall Mode	None	None		None	None		None	C-Max		None	C-Max	None
Walk Time (s)		7.0		7.0	7.0			7.0			7.0	
Flash Dont Walk (s)		18.0		19.0	19.0			10.0			9.0	
Pedestrian Calls (#/hr)		0		0	0			0			0	
Act Effect Green (s)	49.9	49.9		25.9	25.9		76.8	69.8		75.7	69.4	88.4

Lanes, Volumes, Timings

2: NC 86 (N. Columbia St) & W. Rosemary Street/E. Rosemary Street

09/01/2020



Lane Group	EBL	EBT	EBR	WBL	WBT	WBR	NBL	NBT	NBR	SBL	SBT	SBR
Actuated g/C Ratio	0.36	0.36		0.18	0.18		0.55	0.50		0.54	0.50	0.63
v/c Ratio	1.03	0.63		0.60	0.93		0.19	0.60		0.26	0.46	0.51
Control Delay	100.3	44.6		66.0	89.7		5.6	7.3		10.4	14.0	7.7
Queue Delay	0.0	0.0		0.0	0.0		0.0	1.7		0.0	0.2	0.0
Total Delay	100.3	44.6		66.0	89.7		5.6	9.0		10.4	14.2	7.7
LOS	F	D		E	F		A	A		B	B	A
Approach Delay		68.0			83.6			8.7			11.8	
Approach LOS		E			F			A			B	
Queue Length 50th (ft)	~205	291		79	235		7	50		13	96	50
Queue Length 95th (ft)	#353	402		147	#413		m7	m52		m22	105	54
Internal Link Dist (ft)		677			381			273			396	
Turn Bay Length (ft)	100			150			75			150		400
Base Capacity (vph)	254	587		168	311		379	1372		352	1351	649
Starvation Cap Reductn	0	0		0	0		0	363		0	173	0
Spillback Cap Reductn	0	0		0	0		0	0		0	52	0
Storage Cap Reductn	0	0		0	0		0	0		0	0	0
Reduced v/c Ratio	1.03	0.62		0.57	0.89		0.16	0.81		0.21	0.53	0.51

Intersection Summary

Area Type: CBD
 Cycle Length: 140
 Actuated Cycle Length: 140
 Offset: 62 (44%), Referenced to phase 2:NBTL and 6:SBTL, Start of Green
 Natural Cycle: 85
 Control Type: Actuated-Coordinated
 Maximum v/c Ratio: 1.03
 Intersection Signal Delay: 32.1 Intersection LOS: C
 Intersection Capacity Utilization 79.3% ICU Level of Service D
 Analysis Period (min) 15
 ~ Volume exceeds capacity, queue is theoretically infinite.
 Queue shown is maximum after two cycles.
 # 95th percentile volume exceeds capacity, queue may be longer.
 Queue shown is maximum after two cycles.
 m Volume for 95th percentile queue is metered by upstream signal.

Splits and Phases: 2: NC 86 (N. Columbia St) & W. Rosemary Street/E. Rosemary Street

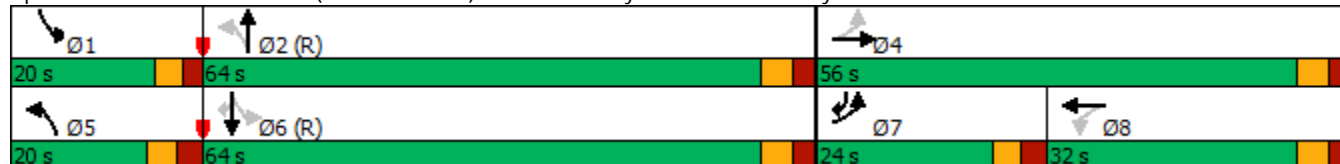

Lanes, Volumes, Timings
6: Henderson Street & E. Rosemary Street

09/01/2020



Lane Group	EBL	EBT	EBR	WBL	WBT	WBR	NBL	NBT	NBR	SBL	SBT	SBR
Lane Configurations												
Traffic Volume (vph)	43	270	138	12	194	57	63	24	5	23	56	10
Future Volume (vph)	43	270	138	12	194	57	63	24	5	23	56	10
Ideal Flow (vphpl)	1900	1900	1900	1900	1900	1900	1900	1900	1900	1900	1900	1900
Grade (%)		0%			0%			0%				3%
Storage Length (ft)	85		0	0		0	0		0	0		0
Storage Lanes	1		0	0		0	0		0	0		0
Taper Length (ft)	25			25			25			25		
Lane Util. Factor	1.00	1.00	1.00	1.00	1.00	1.00	1.00	1.00	1.00	1.00	1.00	1.00
Ped Bike Factor	0.98	0.96			0.98			0.88			0.95	
Frt		0.949			0.971			0.993			0.984	
Flt Protected	0.950				0.998			0.967			0.987	
Satd. Flow (prot)	1593	1523	0	0	1602	0	0	1597	0	0	1565	0
Flt Permitted	0.620				0.979			0.762			0.909	
Satd. Flow (perm)	1016	1523	0	0	1569	0	0	1113	0	0	1399	0
Right Turn on Red			No			No			No			No
Satd. Flow (RTOR)												
Link Speed (mph)		20			20			20			20	
Link Distance (ft)		496			1195			366			450	
Travel Time (s)		16.9			40.7			12.5			15.3	
Confl. Peds. (#/hr)	14		34	34		14	73		51	51		73
Peak Hour Factor	0.90	0.90	0.90	0.93	0.93	0.93	0.67	0.67	0.67	0.79	0.79	0.79
Adj. Flow (vph)	48	300	153	13	209	61	94	36	7	29	71	13
Shared Lane Traffic (%)												
Lane Group Flow (vph)	48	453	0	0	283	0	0	137	0	0	113	0
Turn Type	Perm	NA		Perm	NA		Perm	NA		Perm	NA	
Protected Phases		2			2			4			4	
Permitted Phases	2			2			4			4		
Detector Phase	2	2		2	2		4	4		4	4	
Switch Phase												
Minimum Initial (s)	11.0	11.0		11.0	11.0		8.0	8.0		8.0	8.0	
Minimum Split (s)	15.9	15.9		15.9	15.9		17.8	17.8		17.8	17.8	
Total Split (s)	32.0	32.0		32.0	32.0		38.0	38.0		38.0	38.0	
Total Split (%)	45.7%	45.7%		45.7%	45.7%		54.3%	54.3%		54.3%	54.3%	
Maximum Green (s)	27.1	27.1		27.1	27.1		33.2	33.2		33.2	33.2	
Yellow Time (s)	3.3	3.3		3.3	3.3		3.3	3.3		3.3	3.3	
All-Red Time (s)	1.6	1.6		1.6	1.6		1.5	1.5		1.5	1.5	
Lost Time Adjust (s)	0.1	0.0			0.1			0.2			0.2	
Total Lost Time (s)	5.0	4.9			5.0			5.0			5.0	
Lead/Lag												
Lead-Lag Optimize?												
Vehicle Extension (s)	2.0	2.0		2.0	2.0		2.0	2.0		2.0	2.0	
Recall Mode	C-Max	C-Max		C-Max	C-Max		None	None		None	None	
Walk Time (s)	4.0	4.0		4.0	4.0		4.0	4.0		4.0	4.0	
Flash Dont Walk (s)	7.0	7.0		7.0	7.0		9.0	9.0		9.0	9.0	
Pedestrian Calls (#/hr)	0	0		0	0		0	0		0	0	
Act Effct Green (s)	46.6	46.7			46.6			13.4			13.4	
Actuated g/C Ratio	0.67	0.67			0.67			0.19			0.19	
v/c Ratio	0.07	0.45			0.27			0.64			0.42	

Lanes, Volumes, Timings
 6: Henderson Street & E. Rosemary Street

09/01/2020



Lane Group	EBL	EBT	EBR	WBL	WBT	WBR	NBL	NBT	NBR	SBL	SBT	SBR
Control Delay	6.4	7.7			5.7			30.1			28.2	
Queue Delay	0.0	0.0			0.0			0.0			0.0	
Total Delay	6.4	7.7			5.7			30.1			28.2	
LOS	A	A			A			C			C	
Approach Delay		7.5			5.7			30.1			28.2	
Approach LOS		A			A			C			C	
Queue Length 50th (ft)	6	74			55			52			44	
Queue Length 95th (ft)	m22	178			109			41			66	
Internal Link Dist (ft)		416			1115			286			370	
Turn Bay Length (ft)	85											
Base Capacity (vph)	675	1014			1043			524			659	
Starvation Cap Reductn	0	0			0			0			0	
Spillback Cap Reductn	0	0			0			0			0	
Storage Cap Reductn	0	0			0			0			0	
Reduced v/c Ratio	0.07	0.45			0.27			0.26			0.17	

Intersection Summary

Area Type: CBD
 Cycle Length: 70
 Actuated Cycle Length: 70
 Offset: 14 (20%), Referenced to phase 2:EBWB, Start of Green
 Natural Cycle: 45
 Control Type: Actuated-Coordinated
 Maximum v/c Ratio: 0.64
 Intersection Signal Delay: 12.3
 Intersection LOS: B
 Intersection Capacity Utilization 47.5%
 ICU Level of Service A
 Analysis Period (min) 15
 m Volume for 95th percentile queue is metered by upstream signal.

Splits and Phases: 6: Henderson Street & E. Rosemary Street

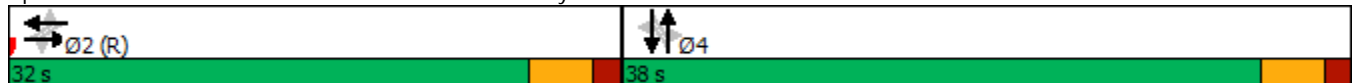

Lanes, Volumes, Timings

7: Hillsborough Street & E. Rosemary Street

09/01/2020



Lane Group	EBL	EBT	EBR	WBL	WBT	WBR	NBL	NBT	NBR	SBL	SBT	SBR
Lane Configurations		↕			↕		↗	↘		↗	↘	
Traffic Volume (vph)	39	135	62	10	99	56	162	295	23	37	203	27
Future Volume (vph)	39	135	62	10	99	56	162	295	23	37	203	27
Ideal Flow (vphpl)	1900	1900	1900	1900	1900	1900	1900	1900	1900	1900	1900	1900
Storage Length (ft)	0		0	0		0	100		0	100		0
Storage Lanes	0		0	0		0	1		0	1		0
Taper Length (ft)	25			25			25			25		
Lane Util. Factor	1.00	1.00	1.00	1.00	1.00	1.00	1.00	1.00	1.00	1.00	1.00	1.00
Ped Bike Factor		0.98			0.97		0.92	1.00		0.98	0.98	
Frt		0.965			0.954			0.989			0.982	
Flt Protected		0.992			0.997		0.950			0.950		
Satd. Flow (prot)	0	1759	0	0	1713	0	1770	1835	0	1770	1787	0
Flt Permitted		0.911			0.976		0.508			0.553		
Satd. Flow (perm)	0	1602	0	0	1675	0	869	1835	0	1010	1787	0
Right Turn on Red			No			No			No			No
Satd. Flow (RTOR)												
Link Speed (mph)		20			20			25			25	
Link Distance (ft)		1195			527			363			726	
Travel Time (s)		40.7			18.0			9.9			19.8	
Confl. Peds. (#/hr)	27		14	14		27	52		9	9		52
Peak Hour Factor	0.86	0.86	0.86	0.79	0.79	0.79	0.92	0.92	0.92	0.96	0.96	0.96
Adj. Flow (vph)	45	157	72	13	125	71	176	321	25	39	211	28
Shared Lane Traffic (%)												
Lane Group Flow (vph)	0	274	0	0	209	0	176	346	0	39	239	0
Turn Type	Perm	NA		Perm	NA		pm+pt	NA		Perm	NA	
Protected Phases		4			8		5	2			6	
Permitted Phases	4			8			2			6		
Detector Phase	4	4		8	8		5	2		6	6	
Switch Phase												
Minimum Initial (s)	7.0	7.0		7.0	7.0		7.0	10.0		10.0	10.0	
Minimum Split (s)	20.0	20.0		17.0	17.0		12.0	15.0		15.0	15.0	
Total Split (s)	30.0	30.0		30.0	30.0		14.0	40.0		26.0	26.0	
Total Split (%)	42.9%	42.9%		42.9%	42.9%		20.0%	57.1%		37.1%	37.1%	
Maximum Green (s)	25.1	25.1		25.0	25.0		9.2	35.2		21.2	21.2	
Yellow Time (s)	3.0	3.0		3.3	3.3		3.0	3.3		3.1	3.1	
All-Red Time (s)	1.9	1.9		1.7	1.7		1.8	1.5		1.7	1.7	
Lost Time Adjust (s)		0.1			0.0		0.2	0.2		0.2	0.2	
Total Lost Time (s)		5.0			5.0		5.0	5.0		5.0	5.0	
Lead/Lag							Lead			Lag	Lag	
Lead-Lag Optimize?												
Vehicle Extension (s)	2.0	2.0		2.0	2.0		2.0	2.0		2.0	2.0	
Recall Mode	None	None		None	None		None	C-Max		C-Max	C-Max	
Walk Time (s)	4.0	4.0		4.0	4.0			4.0		4.0	4.0	
Flash Dont Walk (s)	11.0	11.0		8.0	8.0			6.0		6.0	6.0	
Pedestrian Calls (#/hr)	0	0		0	0			0		0	0	
Act Effct Green (s)		16.2			16.2		43.8	43.8		30.8	30.8	
Actuated g/C Ratio		0.23			0.23		0.63	0.63		0.44	0.44	
v/c Ratio		0.74			0.54		0.27	0.30		0.09	0.30	
Control Delay		32.2			27.9		6.3	6.7		15.4	16.1	

Lanes, Volumes, Timings
 7: Hillsborough Street & E. Rosemary Street

09/01/2020



Lane Group	EBL	EBT	EBR	WBL	WBT	WBR	NBL	NBT	NBR	SBL	SBT	SBR
Queue Delay		0.0			0.0		0.0	0.3		0.0	0.0	
Total Delay		32.2			27.9		6.3	7.0		15.4	16.1	
LOS		C			C		A	A		B	B	
Approach Delay		32.2			27.9			6.7			16.0	
Approach LOS		C			C			A			B	
Queue Length 50th (ft)		109			79		32	81		9	62	
Queue Length 95th (ft)		136			105		65	143		33	142	
Internal Link Dist (ft)		1115			447			283			646	
Turn Bay Length (ft)							100			100		
Base Capacity (vph)		572			598		664	1149		444	787	
Starvation Cap Reductn		0			0		0	348		0	0	
Spillback Cap Reductn		0			0		0	0		0	0	
Storage Cap Reductn		0			0		0	0		0	0	
Reduced v/c Ratio		0.48			0.35		0.27	0.43		0.09	0.30	

Intersection Summary

Area Type:	Other
Cycle Length:	70
Actuated Cycle Length:	70
Offset:	32 (46%), Referenced to phase 2:NBTL and 6:SBTL, Start of Green
Natural Cycle:	50
Control Type:	Actuated-Coordinated
Maximum v/c Ratio:	0.74
Intersection Signal Delay:	17.6
Intersection LOS:	B
Intersection Capacity Utilization	62.6%
ICU Level of Service	B
Analysis Period (min)	15

Splits and Phases: 7: Hillsborough Street & E. Rosemary Street



Lanes, Volumes, Timings

8: Carolina Square Driveway/Church Street & W. Franklin Street

09/01/2020



Lane Group	EBL	EBT	EBR	WBL	WBT	WBR	NBL	NBT	NBR	SBL	SBT	SBR
Lane Configurations												
Traffic Volume (vph)	65	462	18	41	566	72	24	48	40	73	59	75
Future Volume (vph)	65	462	18	41	566	72	24	48	40	73	59	75
Ideal Flow (vphpl)	1900	1900	1900	1900	1900	1900	1900	1900	1900	1900	1900	1900
Lane Width (ft)	10	10	16	10	10	10	12	12	12	12	12	12
Grade (%)		2%			-2%			-4%				-3%
Storage Length (ft)	150		0	200		0	0		100	0		0
Storage Lanes	1		0	1		0	0		1	0		0
Taper Length (ft)	25			25			25			25		
Lane Util. Factor	1.00	1.00	1.00	1.00	1.00	1.00	1.00	1.00	1.00	1.00	1.00	1.00
Ped Bike Factor		0.99		0.88	0.96			0.94	0.88		0.86	
Frt		0.994			0.983				0.850		0.951	
Flt Protected	0.950			0.950				0.983			0.983	
Satd. Flow (prot)	1457	1503	0	1501	1493	0	0	1681	1454	0	1415	0
Flt Permitted	0.286			0.394				0.866			0.851	
Satd. Flow (perm)	439	1503	0	546	1493	0	0	1387	1282	0	1187	0
Right Turn on Red			No			No			No			No
Satd. Flow (RTOR)												
Link Speed (mph)		20			20			20			25	
Link Distance (ft)		993			294			285			379	
Travel Time (s)		33.9			10.0			9.7			10.3	
Confl. Peds. (#/hr)	124		164	164		124	175		63	63		175
Peak Hour Factor	0.91	0.91	0.91	0.93	0.93	0.93	0.81	0.81	0.81	0.91	0.91	0.91
Heavy Vehicles (%)	3%	3%	3%	2%	2%	2%	2%	2%	2%	2%	2%	2%
Adj. Flow (vph)	71	508	20	44	609	77	30	59	49	80	65	82
Shared Lane Traffic (%)												
Lane Group Flow (vph)	71	528	0	44	686	0	0	89	49	0	227	0
Turn Type	Perm	NA		Perm	NA		Perm	NA	Perm	Perm	NA	
Protected Phases		2			6			8				4
Permitted Phases	2			6			8		8	4		
Detector Phase	2	2		6	6		8	8	8	4	4	
Switch Phase												
Minimum Initial (s)	10.0	10.0		10.0	10.0		7.0	7.0	7.0	7.0	7.0	
Minimum Split (s)	22.0	22.0		19.0	19.0		29.0	29.0	29.0	27.0	27.0	
Total Split (s)	41.0	41.0		41.0	41.0		29.0	29.0	29.0	29.0	29.0	
Total Split (%)	58.6%	58.6%		58.6%	58.6%		41.4%	41.4%	41.4%	41.4%	41.4%	
Maximum Green (s)	35.4	35.4		35.4	35.4		22.7	22.7	22.7	23.0	23.0	
Yellow Time (s)	3.3	3.3		3.3	3.3		3.1	3.1	3.1	3.4	3.4	
All-Red Time (s)	2.3	2.3		2.3	2.3		3.2	3.2	3.2	2.6	2.6	
Lost Time Adjust (s)	-0.6	-0.6		-0.6	-0.6		-1.3	-1.3	-1.3		-1.0	
Total Lost Time (s)	5.0	5.0		5.0	5.0		5.0	5.0	5.0		5.0	
Lead/Lag												
Lead-Lag Optimize?												
Vehicle Extension (s)	3.0	3.0		3.0	3.0		2.0	2.0	2.0	2.0	2.0	
Recall Mode	C-Max	C-Max		C-Max	C-Max		None	None	None	None	None	
Walk Time (s)	7.0	7.0		7.0	7.0		7.0	7.0	7.0	7.0	7.0	
Flash Dont Walk (s)	9.0	9.0		6.0	6.0		15.0	15.0	15.0	14.0	14.0	
Pedestrian Calls (#/hr)	0	0		0	0		0	0	0	0	0	
Act Effect Green (s)	42.0	42.0		42.0	42.0		18.0	18.0	18.0		18.0	

Lanes, Volumes, Timings

8: Carolina Square Driveway/Church Street & W. Franklin Street

09/01/2020



Lane Group	EBL	EBT	EBR	WBL	WBT	WBR	NBL	NBT	NBR	SBL	SBT	SBR
Actuated g/C Ratio	0.60	0.60		0.60	0.60			0.26	0.26		0.26	
v/c Ratio	0.27	0.59		0.13	0.77			0.25	0.15		0.74	
Control Delay	12.2	13.5		10.1	17.5			20.4	18.8		35.7	
Queue Delay	0.0	0.0		0.0	0.0			0.0	0.0		0.0	
Total Delay	12.2	13.5		10.1	17.5			20.4	18.8		35.7	
LOS	B	B		B	B			C	B		D	
Approach Delay		13.4			17.0			19.8			35.7	
Approach LOS		B			B			B			D	
Queue Length 50th (ft)	13	128		15	324			30	16		102	
Queue Length 95th (ft)	46	268		m18	m325			51	32		112	
Internal Link Dist (ft)		913			214			205			299	
Turn Bay Length (ft)	150			200					100			
Base Capacity (vph)	263	900		327	894			475	439		406	
Starvation Cap Reductn	0	0		0	0			0	0		0	
Spillback Cap Reductn	0	0		0	0			0	0		0	
Storage Cap Reductn	0	0		0	0			0	0		0	
Reduced v/c Ratio	0.27	0.59		0.13	0.77			0.19	0.11		0.56	

Intersection Summary

Area Type:	CBD
Cycle Length:	70
Actuated Cycle Length:	70
Offset:	66 (94%), Referenced to phase 2:EBTL and 6:WBTL, Start of Green
Natural Cycle:	70
Control Type:	Actuated-Coordinated
Maximum v/c Ratio:	0.77
Intersection Signal Delay:	18.5
Intersection LOS:	B
Intersection Capacity Utilization:	81.9%
ICU Level of Service:	D
Analysis Period (min):	15
m Volume for 95th percentile queue is metered by upstream signal.	

Splits and Phases: 8: Carolina Square Driveway/Church Street & W. Franklin Street

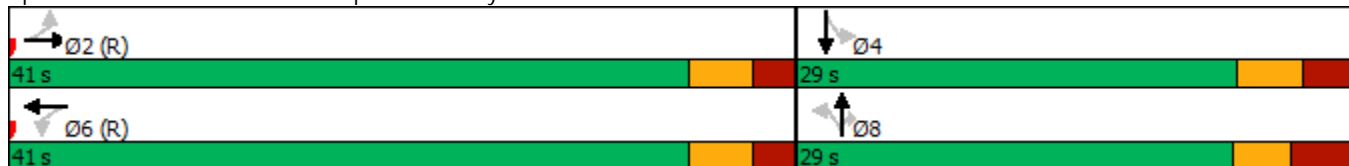

Lanes, Volumes, Timings

9: NC 86 (S. Columbia St)/NC 86 (N. Columbia St) & W. Franklin Street/E. Franklin Street 09/01/2020



Lane Group	EBL	EBT	EBR	WBL	WBT	WBR	NBL	NBT	NBR	SBL	SBT	SBR
Lane Configurations												
Traffic Volume (vph)	177	430	75	101	514	66	64	561	112	73	417	120
Future Volume (vph)	177	430	75	101	514	66	64	561	112	73	417	120
Ideal Flow (vphpl)	1900	1900	1900	1900	1900	1900	1900	1900	1900	1900	1900	1900
Lane Width (ft)	9	12	13	10	10	13	9	10	10	9	9	11
Grade (%)		3%			1%			-2%			3%	
Storage Length (ft)	250		0	125		0	475		0	125		0
Storage Lanes	1		0	1		1	1		0	1		0
Taper Length (ft)	25			25			25			25		
Lane Util. Factor	1.00	0.95	0.95	1.00	1.00	1.00	1.00	0.95	0.95	1.00	0.95	0.95
Ped Bike Factor	0.87	0.96		0.87		0.68	0.90	0.96		0.93	0.95	
Frt		0.978				0.850		0.975			0.966	
Flt Protected	0.950			0.950			0.950			0.950		
Satd. Flow (prot)	1412	2934	0	1479	1557	1465	1380	2692	0	1385	2538	0
Flt Permitted	0.950			0.950			0.950			0.950		
Satd. Flow (perm)	1223	2934	0	1287	1557	997	1247	2692	0	1284	2538	0
Right Turn on Red			No			No			No			No
Satd. Flow (RTOR)												
Link Speed (mph)		20			20			25			25	
Link Distance (ft)		461			941			981			353	
Travel Time (s)		15.7			32.1			26.8			9.6	
Confl. Peds. (#/hr)	193		152	152		193	67		108	108		67
Peak Hour Factor	0.87	0.87	0.87	0.84	0.84	0.84	0.90	0.90	0.90	0.94	0.94	0.94
Heavy Vehicles (%)	2%	2%	2%	2%	2%	2%	7%	7%	7%	4%	4%	4%
Adj. Flow (vph)	203	494	86	120	612	79	71	623	124	78	444	128
Shared Lane Traffic (%)												
Lane Group Flow (vph)	203	580	0	120	612	79	71	747	0	78	572	0
Turn Type	Prot	NA		Prot	NA	pm+ov	Prot	NA		Prot	NA	
Protected Phases	5	2		1	6	7	3	8		7	4	
Permitted Phases						6						
Detector Phase	5	2		1	6	7	3	8		7	4	
Switch Phase												
Minimum Initial (s)	7.0	10.0		7.0	10.0	7.0	7.0	7.0		7.0	7.0	
Minimum Split (s)	15.0	28.2		15.0	28.2	15.0	15.0	28.0		15.0	28.1	
Total Split (s)	22.0	36.0		43.0	57.0	15.0	21.0	46.0		15.0	40.0	
Total Split (%)	15.7%	25.7%		30.7%	40.7%	10.7%	15.0%	32.9%		10.7%	28.6%	
Maximum Green (s)	16.6	29.8		37.1	50.8	9.1	15.1	40.1		9.1	34.3	
Yellow Time (s)	3.0	3.0		3.0	3.0	3.0	3.0	3.3		3.0	3.1	
All-Red Time (s)	2.4	3.2		2.9	3.2	2.9	2.9	2.6		2.9	2.6	
Lost Time Adjust (s)	-0.4	-1.2		-0.9	-1.2	-2.0	-0.9	-0.9		-0.9	-0.7	
Total Lost Time (s)	5.0	5.0		5.0	5.0	3.9	5.0	5.0		5.0	5.0	
Lead/Lag	Lead	Lag		Lead	Lag	Lead	Lead	Lag		Lead	Lag	
Lead-Lag Optimize?	Yes	Yes		Yes	Yes	Yes	Yes	Yes		Yes	Yes	
Vehicle Extension (s)	1.0	3.0		1.0	3.0	1.0	1.0	2.0		1.0	2.0	
Recall Mode	None	C-Max		None	C-Max	None	None	Ped		None	Ped	
Walk Time (s)		7.0			7.0			7.0			7.0	
Flash Dont Walk (s)		15.0			15.0			15.0			15.0	
Pedestrian Calls (#/hr)		0			0			0			0	
Act Effect Green (s)	18.0	54.2		15.8	52.0	63.8	11.7	40.4		9.6	40.9	

Lanes, Volumes, Timings

9: NC 86 (S. Columbia St)/NC 86 (N. Columbia St) & W. Franklin Street/E. Franklin Street 09/01/2020



Lane Group	EBL	EBT	EBR	WBL	WBT	WBR	NBL	NBT	NBR	SBL	SBT	SBR
Actuated g/C Ratio	0.13	0.39		0.11	0.37	0.46	0.08	0.29		0.07	0.29	
v/c Ratio	1.12	0.51		0.72	1.06	0.16	0.62	0.96		0.83	0.77	
Control Delay	152.0	36.1		94.2	88.9	21.3	101.0	25.0		127.9	36.0	
Queue Delay	0.0	0.0		0.0	0.0	0.0	0.0	0.0		0.0	0.8	
Total Delay	152.0	36.1		94.2	88.9	21.3	101.0	25.0		127.9	36.9	
LOS	F	D		F	F	C	F	C		F	D	
Approach Delay		66.1			83.1			31.6			47.8	
Approach LOS		E			F			C			D	
Queue Length 50th (ft)	~224	198		112	-628	31	62	236		75	113	
Queue Length 95th (ft)	#367	297		167	#770	53	m60	m175		m#167	#359	
Internal Link Dist (ft)		381			861			901			273	
Turn Bay Length (ft)	250			125			475			125		
Base Capacity (vph)	181	1135		401	578	494	157	788		98	741	
Starvation Cap Reductn	0	0		0	0	0	0	0		0	39	
Spillback Cap Reductn	0	0		0	0	0	0	0		0	0	
Storage Cap Reductn	0	0		0	0	0	0	0		0	0	
Reduced v/c Ratio	1.12	0.51		0.30	1.06	0.16	0.45	0.95		0.80	0.81	

Intersection Summary

Area Type: CBD
 Cycle Length: 140
 Actuated Cycle Length: 140
 Offset: 0 (0%), Referenced to phase 2:EBT and 6:WBT, Start of Green
 Natural Cycle: 150
 Control Type: Actuated-Coordinated
 Maximum v/c Ratio: 1.12
 Intersection Signal Delay: 57.5 Intersection LOS: E
 Intersection Capacity Utilization 85.7% ICU Level of Service E
 Analysis Period (min) 15
 ~ Volume exceeds capacity, queue is theoretically infinite.
 Queue shown is maximum after two cycles.
 # 95th percentile volume exceeds capacity, queue may be longer.
 Queue shown is maximum after two cycles.
 m Volume for 95th percentile queue is metered by upstream signal.

Splits and Phases: 9: NC 86 (S. Columbia St)/NC 86 (N. Columbia St) & W. Franklin Street/E. Franklin Street



Lanes, Volumes, Timings
 10: E. Franklin Street & Henderson Street

09/01/2020



Lane Group	EBL	EBT	WBT	WBR	SBL	SBR
Lane Configurations		↕↕	↕↔		↔↕	
Traffic Volume (vph)	34	601	648	67	150	57
Future Volume (vph)	34	601	648	67	150	57
Ideal Flow (vphpl)	1900	1900	1900	1900	1900	1900
Lane Width (ft)	10	13	10	10	11	11
Grade (%)		-2%	2%		3%	
Lane Util. Factor	0.95	0.95	0.95	0.95	1.00	1.00
Ped Bike Factor		1.00	0.97		0.87	
Frt			0.986		0.963	
Flt Protected		0.997			0.965	
Satd. Flow (prot)	0	3282	2826	0	1391	0
Flt Permitted		0.885			0.965	
Satd. Flow (perm)	0	2901	2826	0	1293	0
Right Turn on Red				No		No
Satd. Flow (RTOR)						
Link Speed (mph)		20	20		20	
Link Distance (ft)		941	1200		366	
Travel Time (s)		32.1	40.9		12.5	
Confl. Peds. (#/hr)	114			114	88	198
Peak Hour Factor	0.90	0.90	0.93	0.93	0.83	0.83
Heavy Vehicles (%)	3%	3%	2%	2%	2%	2%
Parking (#/hr)						0
Adj. Flow (vph)	38	668	697	72	181	69
Shared Lane Traffic (%)						
Lane Group Flow (vph)	0	706	769	0	250	0
Turn Type	Perm	NA	NA		Prot	
Protected Phases		2	6		4	
Permitted Phases	2					
Detector Phase	2	2	6		4	
Switch Phase						
Minimum Initial (s)	10.0	10.0	10.0		7.0	
Minimum Split (s)	16.2	16.2	21.1		24.1	
Total Split (s)	43.0	43.0	43.0		27.0	
Total Split (%)	61.4%	61.4%	61.4%		38.6%	
Maximum Green (s)	36.8	36.8	36.9		21.9	
Yellow Time (s)	3.0	3.0	3.0		3.0	
All-Red Time (s)	3.2	3.2	3.1		2.1	
Lost Time Adjust (s)		-1.2	-1.1		-0.1	
Total Lost Time (s)		5.0	5.0		5.0	
Lead/Lag						
Lead-Lag Optimize?						
Vehicle Extension (s)	2.0	2.0	2.0		1.0	
Recall Mode	C-Max	C-Max	C-Max		None	
Walk Time (s)			7.0		7.0	
Flash Dont Walk (s)			8.0		12.0	
Pedestrian Calls (#/hr)			0		0	
Act Effct Green (s)		44.1	44.1		15.9	
Actuated g/C Ratio		0.63	0.63		0.23	
v/c Ratio		0.39	0.43		0.79	

Lanes, Volumes, Timings
 10: E. Franklin Street & Henderson Street

09/01/2020



Lane Group	EBL	EBT	WBT	WBR	SBL	SBR
Control Delay		9.0	5.3		40.2	
Queue Delay		0.0	0.0		0.0	
Total Delay		9.0	5.3		40.2	
LOS		A	A		D	
Approach Delay		9.0	5.3		40.2	
Approach LOS		A	A		D	
Queue Length 50th (ft)		187	69		110	
Queue Length 95th (ft)		m180	135		126	
Internal Link Dist (ft)		861	1120		286	
Turn Bay Length (ft)						
Base Capacity (vph)		1827	1780		437	
Starvation Cap Reductn		0	0		0	
Spillback Cap Reductn		0	0		0	
Storage Cap Reductn		0	0		0	
Reduced v/c Ratio		0.39	0.43		0.57	

Intersection Summary

Area Type:	CBD
Cycle Length:	70
Actuated Cycle Length:	70
Offset:	27 (39%), Referenced to phase 2:EBTL and 6:WBT, Start of Green
Natural Cycle:	50
Control Type:	Actuated-Coordinated
Maximum v/c Ratio:	0.79
Intersection Signal Delay:	11.9
Intersection LOS:	B
Intersection Capacity Utilization:	70.8%
ICU Level of Service:	C
Analysis Period (min):	15
m Volume for 95th percentile queue is metered by upstream signal.	

Splits and Phases: 10: E. Franklin Street & Henderson Street

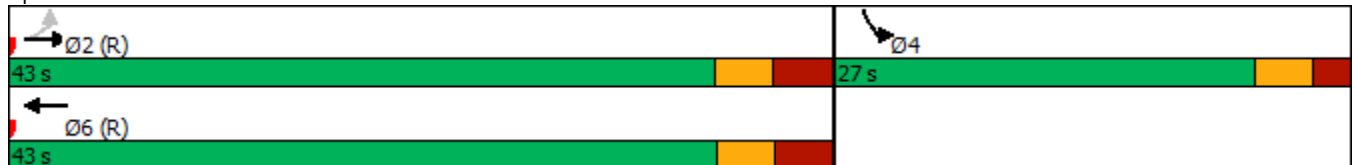

Lanes, Volumes, Timings

11: Raleigh Street/Hillsborough Street & E. Franklin Street

09/01/2020



Lane Group	EBL	EBT	EBR	WBL	WBT	WBR	NBL	NBT	NBR	SBL	SBT	SBR
Lane Configurations												
Traffic Volume (vph)	51	540	232	62	662	240	50	197	23	54	201	13
Future Volume (vph)	51	540	232	62	662	240	50	197	23	54	201	13
Ideal Flow (vphpl)	1900	1900	1900	1900	1900	1900	1900	1900	1900	1900	1900	1900
Lane Width (ft)	9	9	10	9	10	11	12	12	12	10	10	10
Grade (%)		1%			-2%			1%			1%	
Storage Length (ft)	75		0	75		0	0		0	100		0
Storage Lanes	1		0	1		0	0		0	1		0
Taper Length (ft)	25			25			25			25		
Lane Util. Factor	1.00	0.95	0.95	1.00	0.95	0.95	1.00	1.00	1.00	1.00	1.00	1.00
Ped Bike Factor	1.00	0.99		1.00	0.99			0.99		0.99	0.99	
Frt		0.955			0.960			0.988			0.991	
Flt Protected	0.950			0.950				0.991		0.950		
Satd. Flow (prot)	1585	2995	0	1609	3173	0	0	1811	0	1643	1702	0
Flt Permitted	0.251			0.298				0.700		0.399		
Satd. Flow (perm)	417	2995	0	502	3173	0	0	1267	0	686	1702	0
Right Turn on Red			No			No			No			No
Satd. Flow (RTOR)												
Link Speed (mph)		20			30			25			25	
Link Distance (ft)		1200			1013			995			363	
Travel Time (s)		40.9			23.0			27.1			9.9	
Confl. Peds. (#/hr)	16		16	16		16	58		7	7		58
Peak Hour Factor	0.91	0.91	0.91	0.92	0.92	0.92	0.93	0.93	0.93	0.88	0.88	0.88
Adj. Flow (vph)	56	593	255	67	720	261	54	212	25	61	228	15
Shared Lane Traffic (%)												
Lane Group Flow (vph)	56	848	0	67	981	0	0	291	0	61	243	0
Turn Type	Perm	NA		Perm	NA		pm+pt	NA		D.Pm	NA	
Protected Phases		2			6		7	4				8
Permitted Phases	2			6			4			4		
Detector Phase	2	2		6	6		7	4		4		8
Switch Phase												
Minimum Initial (s)	10.0	10.0		10.0	10.0		7.0	7.0		7.0	7.0	
Minimum Split (s)	16.0	16.0		16.0	16.0		14.0	30.0		30.0	29.0	
Total Split (s)	79.0	79.0		79.0	79.0		14.0	61.0		61.0	47.0	
Total Split (%)	56.4%	56.4%		56.4%	56.4%		10.0%	43.6%		43.6%	33.6%	
Maximum Green (s)	73.7	73.7		73.7	73.7		7.8	54.6		54.6	40.6	
Yellow Time (s)	3.0	3.0		3.0	3.0		3.0	3.1		3.1	3.1	
All-Red Time (s)	2.3	2.3		2.3	2.3		3.2	3.3		3.3	3.3	
Lost Time Adjust (s)	-0.3	-0.3		-0.3	-0.3			-1.4		-1.4	-1.4	
Total Lost Time (s)	5.0	5.0		5.0	5.0			5.0		5.0	5.0	
Lead/Lag							Lead				Lag	
Lead-Lag Optimize?												
Vehicle Extension (s)	3.0	3.0		3.0	3.0		3.0	2.0		2.0	2.0	
Recall Mode	C-Max	C-Max		C-Max	C-Max		None	None		None	None	
Walk Time (s)								7.0		7.0	7.0	
Flash Dont Walk (s)								16.0		16.0	15.0	
Pedestrian Calls (#/hr)								0		0	0	
Act Effect Green (s)	94.4	94.4		94.4	94.4			35.6		35.6	35.6	
Actuated g/C Ratio	0.67	0.67		0.67	0.67			0.25		0.25	0.25	

Lanes, Volumes, Timings

11: Raleigh Street/Hillsborough Street & E. Franklin Street

09/01/2020



Lane Group	EBL	EBT	EBR	WBL	WBT	WBR	NBL	NBT	NBR	SBL	SBT	SBR
v/c Ratio	0.20	0.42		0.20	0.46			0.90		0.35	0.56	
Control Delay	6.0	4.8		12.5	12.7			80.4		40.9	43.5	
Queue Delay	0.0	0.0		0.0	0.0			0.0		0.0	0.9	
Total Delay	6.0	4.8		12.5	12.7			80.4		40.9	44.4	
LOS	A	A		B	B			F		D	D	
Approach Delay		4.9			12.7			80.4			43.7	
Approach LOS		A			B			F			D	
Queue Length 50th (ft)	8	68		21	206			258		43	171	
Queue Length 95th (ft)	m19	97		57	321			341		72	214	
Internal Link Dist (ft)		1120			933			915			283	
Turn Bay Length (ft)	75			75						100		
Base Capacity (vph)	280	2018		338	2138			506		274	522	
Starvation Cap Reductn	0	0		0	0			0		0	105	
Spillback Cap Reductn	0	0		0	0			0		0	0	
Storage Cap Reductn	0	0		0	0			0		0	0	
Reduced v/c Ratio	0.20	0.42		0.20	0.46			0.58		0.22	0.58	

Intersection Summary

Area Type: Other
 Cycle Length: 140
 Actuated Cycle Length: 140
 Offset: 73 (52%), Referenced to phase 2:EBTL and 6:WBTL, Start of Green
 Natural Cycle: 70
 Control Type: Actuated-Coordinated
 Maximum v/c Ratio: 0.90
 Intersection Signal Delay: 21.3 Intersection LOS: C
 Intersection Capacity Utilization 84.3% ICU Level of Service E
 Analysis Period (min) 15
 m Volume for 95th percentile queue is metered by upstream signal.

Splits and Phases: 11: Raleigh Street/Hillsborough Street & E. Franklin Street

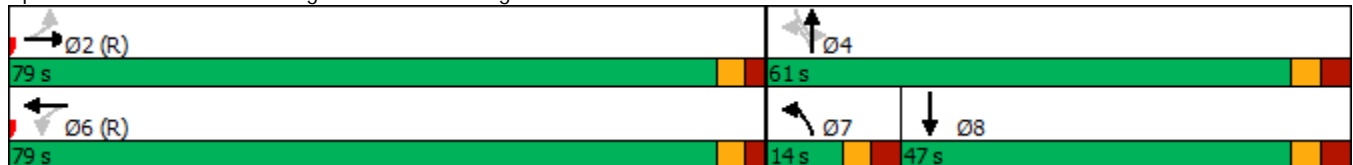

Lanes, Volumes, Timings

13: NC 86 (N. Columbia St)/NC 86 (MLK Jr. Blvd) & North Street & N. Columbia Street 09/01/2020

Lane Group	WBL	WBR	WBR2	NBL	NBT	NBR	SBL	SBT	SBR	SEL2	SEL	SER
Lane Configurations												
Traffic Volume (vph)	24	21	147	49	792	23	53	724	6	4	5	100
Future Volume (vph)	24	21	147	49	792	23	53	724	6	4	5	100
Ideal Flow (vphpl)	1900	1900	1900	1900	1900	1900	1900	1900	1900	1900	1900	1900
Grade (%)	2%				-5%			5%				-3%
Storage Length (ft)	0	0		150		0	70		0		0	0
Storage Lanes	1	0		1		0	1		0		1	0
Taper Length (ft)	25			25			25				25	
Lane Util. Factor	1.00	1.00	1.00	1.00	0.95	0.95	1.00	0.95	0.95	1.00	1.00	1.00
Ped Bike Factor				1.00	1.00		0.99	1.00			1.00	
Frt	0.882				0.996			0.999				0.875
Flt Protected	0.994			0.950			0.950				0.996	
Satd. Flow (prot)	1617	0	0	1796	3573	0	1709	3413	0	0	1601	0
Flt Permitted	0.994			0.288			0.232				0.996	
Satd. Flow (perm)	1617	0	0	544	3573	0	415	3413	0	0	1598	0
Right Turn on Red			No			No			No			No
Satd. Flow (RTOR)												
Link Speed (mph)	20				35			35				25
Link Distance (ft)	246				476			2108				715
Travel Time (s)	8.4				9.3			41.1				19.5
Confl. Peds. (#/hr)				7		32	32		7	8		
Peak Hour Factor	0.87	0.87	0.87	0.83	0.83	0.83	0.88	0.88	0.88	0.92	0.92	0.92
Heavy Vehicles (%)	2%	2%	2%	3%	3%	3%	3%	3%	3%	5%	5%	5%
Adj. Flow (vph)	28	24	169	59	954	28	60	823	7	4	5	109
Shared Lane Traffic (%)												
Lane Group Flow (vph)	221	0	0	59	982	0	60	830	0	0	118	0
Turn Type	Prot			Perm	NA		Perm	NA		Prot	Prot	
Protected Phases	3				2			6		4	4	
Permitted Phases				2			6					
Detector Phase	3			2	2		6	6		4	4	
Switch Phase												
Minimum Initial (s)	7.0			10.0	10.0		10.0	10.0		7.0	7.0	
Minimum Split (s)	14.0			17.0	17.0		17.0	17.0		14.0	14.0	
Total Split (s)	35.0			85.0	85.0		85.0	85.0		20.0	20.0	
Total Split (%)	25.0%			60.7%	60.7%		60.7%	60.7%		14.3%	14.3%	
Maximum Green (s)	28.0			78.0	78.0		78.0	78.0		13.0	13.0	
Yellow Time (s)	5.0			5.0	5.0		5.0	5.0		5.0	5.0	
All-Red Time (s)	2.0			2.0	2.0		2.0	2.0		2.0	2.0	
Lost Time Adjust (s)	-2.0			-2.0	-2.0		-2.0	-2.0			-2.0	
Total Lost Time (s)	5.0			5.0	5.0		5.0	5.0			5.0	
Lead/Lag	Lead									Lag	Lag	
Lead-Lag Optimize?	Yes									Yes	Yes	
Vehicle Extension (s)	3.0			3.0	3.0		3.0	3.0		3.0	3.0	
Recall Mode	None			C-Max	C-Max		C-Max	C-Max		None	None	
Act Effect Green (s)	25.4			84.5	84.5		84.5	84.5			15.1	
Actuated g/C Ratio	0.18			0.60	0.60		0.60	0.60			0.11	
v/c Ratio	0.76			0.18	0.46		0.24	0.40			0.68	
Control Delay	70.5			12.6	12.6		17.6	16.0			80.0	
Queue Delay	0.0			0.0	0.2		0.0	0.0			0.0	

Lanes, Volumes, Timings

13: NC 86 (N. Columbia St)/NC 86 (MLK Jr. Blvd) & North Street & N. Columbia Street 09/01/2020



Lane Group	WBL	WBR	WBR2	NBL	NBT	NBR	SBL	SBT	SBR	SEL2	SEL	SER
Total Delay	70.5			12.6	12.8		17.6	16.0			80.0	
LOS	E			B	B		B	B			E	
Approach Delay	70.5				12.8			16.1			80.0	
Approach LOS	E				B			B			E	
Queue Length 50th (ft)	191			17	151		26	213			103	
Queue Length 95th (ft)	266			m25	m156		56	256			#193	
Internal Link Dist (ft)	166				396			2028			635	
Turn Bay Length (ft)				150			70					
Base Capacity (vph)	346			328	2156		250	2060			180	
Starvation Cap Reductn	0			0	478		0	0			0	
Spillback Cap Reductn	0			0	0		0	0			0	
Storage Cap Reductn	0			0	0		0	0			0	
Reduced v/c Ratio	0.64			0.18	0.59		0.24	0.40			0.66	

Intersection Summary

Area Type: Other
 Cycle Length: 140
 Actuated Cycle Length: 140
 Offset: 51 (36%), Referenced to phase 2:NBTL and 6:SBTL, Start of Green
 Natural Cycle: 60
 Control Type: Actuated-Coordinated
 Maximum v/c Ratio: 0.76
 Intersection Signal Delay: 23.2 Intersection LOS: C
 Intersection Capacity Utilization 66.1% ICU Level of Service C
 Analysis Period (min) 15
 # 95th percentile volume exceeds capacity, queue may be longer.
 Queue shown is maximum after two cycles.
 m Volume for 95th percentile queue is metered by upstream signal.

Splits and Phases: 13: NC 86 (N. Columbia St)/NC 86 (MLK Jr. Blvd) & North Street & N. Columbia Street

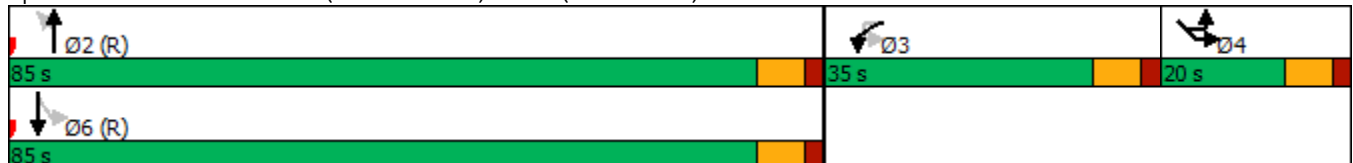

Lanes, Volumes, Timings

14: NC 86 (MLK Jr. Blvd) & Longview Street/Mill Creek Apts Driveway

09/01/2020



Lane Group	EBL	EBT	EBR	WBL	WBT	WBR	NBL	NBT	NBR	SBL	SBT	SBR
Lane Configurations		↕			↕		↕	↕		↕	↕	
Traffic Volume (vph)	96	2	18	34	1	8	14	920	13	11	659	77
Future Volume (vph)	96	2	18	34	1	8	14	920	13	11	659	77
Ideal Flow (vphpl)	1900	1900	1900	1900	1900	1900	1900	1900	1900	1900	1900	1900
Grade (%)		-6%			1%			2%			-4%	
Storage Length (ft)	0		0	0		0	225		0	250		0
Storage Lanes	0		0	0		0	1		0	1		0
Taper Length (ft)	25			25			25			25		
Lane Util. Factor	1.00	1.00	1.00	1.00	1.00	1.00	1.00	0.95	0.95	1.00	0.95	0.95
Ped Bike Factor		0.99			0.99		0.99	1.00		0.99	1.00	
Frt		0.979			0.974			0.998			0.984	
Flt Protected		0.960			0.962		0.950			0.950		
Satd. Flow (prot)	0	1794	0	0	1732	0	1735	3459	0	1787	3504	0
Flt Permitted		0.723			0.754		0.343			0.226		
Satd. Flow (perm)	0	1349	0	0	1341	0	623	3459	0	420	3504	0
Right Turn on Red			No			No			No			No
Satd. Flow (RTOR)												
Link Speed (mph)		25			20			35			35	
Link Distance (ft)		451			338			2108			784	
Travel Time (s)		12.3			11.5			41.1			15.3	
Confl. Peds. (#/hr)	2		20	20		2	7		28	28		7
Peak Hour Factor	0.89	0.89	0.89	0.75	0.75	0.75	0.86	0.86	0.86	0.93	0.93	0.93
Heavy Vehicles (%)	2%	2%	2%	2%	2%	2%	3%	3%	3%	3%	3%	3%
Adj. Flow (vph)	108	2	20	45	1	11	16	1070	15	12	709	83
Shared Lane Traffic (%)												
Lane Group Flow (vph)	0	130	0	0	57	0	16	1085	0	12	792	0
Turn Type	Perm	NA		Perm	NA		Perm	NA		Perm	NA	
Protected Phases		4			8			2			6	
Permitted Phases	4			8			2			6		
Detector Phase	4	4		8	8		2	2		6	6	
Switch Phase												
Minimum Initial (s)	7.0	7.0		7.0	7.0		12.0	12.0		12.0	12.0	
Minimum Split (s)	31.0	31.0		14.0	14.0		28.0	28.0		28.0	28.0	
Total Split (s)	20.0	20.0		20.0	20.0		60.0	60.0		60.0	60.0	
Total Split (%)	25.0%	25.0%		25.0%	25.0%		75.0%	75.0%		75.0%	75.0%	
Maximum Green (s)	14.0	14.0		13.9	13.9		54.0	54.0		54.5	54.5	
Yellow Time (s)	3.5	3.5		3.0	3.0		4.5	4.5		4.0	4.0	
All-Red Time (s)	2.5	2.5		3.1	3.1		1.5	1.5		1.5	1.5	
Lost Time Adjust (s)		-1.0			-1.0		-1.0	-1.0		-0.5	-0.5	
Total Lost Time (s)		5.0			5.1		5.0	5.0		5.0	5.0	
Lead/Lag												
Lead-Lag Optimize?												
Vehicle Extension (s)	3.0	3.0		3.0	3.0		3.0	3.0		3.0	3.0	
Recall Mode	None	None		None	None		Min	Min		Min	Min	
Walk Time (s)	7.0	7.0					7.0	7.0		7.0	7.0	
Flash Dont Walk (s)	17.0	17.0					9.0	9.0		9.0	9.0	
Pedestrian Calls (#/hr)	0	0					0	0		0	0	
Act Effct Green (s)		10.9			10.8		28.3	28.3		28.3	28.3	
Actuated g/C Ratio		0.24			0.24		0.63	0.63		0.63	0.63	

Lanes, Volumes, Timings

14: NC 86 (MLK Jr. Blvd) & Longview Street/Mill Creek Apts Driveway

09/01/2020



Lane Group	EBL	EBT	EBR	WBL	WBT	WBR	NBL	NBT	NBR	SBL	SBT	SBR
v/c Ratio		0.40			0.18		0.04	0.50		0.05	0.36	
Control Delay		20.2			17.0		5.7	7.5		6.0	6.4	
Queue Delay		0.0			0.0		0.0	0.0		0.0	0.0	
Total Delay		20.2			17.0		5.7	7.5		6.0	6.4	
LOS		C			B		A	A		A	A	
Approach Delay		20.2			17.0			7.5			6.4	
Approach LOS		C			B			A			A	
Queue Length 50th (ft)		28			12		2	83		1	54	
Queue Length 95th (ft)		78			33		9	144		8	102	
Internal Link Dist (ft)		371			258			2028			704	
Turn Bay Length (ft)							225			250		
Base Capacity (vph)		470			464		616	3422		415	3467	
Starvation Cap Reductn		0			0		0	0		0	0	
Spillback Cap Reductn		0			0		0	0		0	0	
Storage Cap Reductn		0			0		0	0		0	0	
Reduced v/c Ratio		0.28			0.12		0.03	0.32		0.03	0.23	

Intersection Summary

Area Type: Other

Cycle Length: 80

Actuated Cycle Length: 44.7

Natural Cycle: 60

Control Type: Actuated-Uncoordinated

Maximum v/c Ratio: 0.50

Intersection Signal Delay: 8.1

Intersection LOS: A

Intersection Capacity Utilization 47.8%

ICU Level of Service A

Analysis Period (min) 15

Splits and Phases: 14: NC 86 (MLK Jr. Blvd) & Longview Street/Mill Creek Apts Driveway



Lanes, Volumes, Timings
 15: NC 86 (Pittsboro St) & W. Cameron Avenue

09/01/2020



Lane Group	EBT	EBR	WBL	WBT	NBL	NBR	Ø1	Ø4
Lane Configurations	↻		↻↻	↻				
Traffic Volume (vph)	148	220	544	359	0	0		
Future Volume (vph)	148	220	544	359	0	0		
Ideal Flow (vphpl)	1900	1900	1900	1900	1900	1900		
Lane Width (ft)	12	12	11	12	12	12		
Grade (%)	3%			-3%	0%			
Storage Length (ft)		0	75		0	0		
Storage Lanes		0	0		0	0		
Taper Length (ft)			25		25			
Lane Util. Factor	1.00	1.00	0.97	1.00	1.00	1.00		
Ped Bike Factor	0.84		0.74					
Frt	0.919							
Flt Protected			0.950					
Satd. Flow (prot)	1269	0	2890	1622	0	0		
Flt Permitted			0.950					
Satd. Flow (perm)	1269	0	2147	1622	0	0		
Right Turn on Red		No				No		
Satd. Flow (RTOR)								
Link Speed (mph)	25			25	25			
Link Distance (ft)	391			120	794			
Travel Time (s)	30.0			10.7	21.7			
Confl. Peds. (#/hr)		70	70					
Peak Hour Factor	0.93	0.93	0.96	0.96	0.90	0.90		
Heavy Vehicles (%)	2%	2%	7%	7%	2%	2%		
Adj. Flow (vph)	159	237	567	374	0	0		
Shared Lane Traffic (%)								
Lane Group Flow (vph)	396	0	567	374	0	0		
Turn Type	NA		Prot	NA				
Protected Phases	2		1 4	6			1	4
Permitted Phases								
Detector Phase	2		1 4	6				
Switch Phase								
Minimum Initial (s)	10.0			10.0			7.0	7.0
Minimum Split (s)	20.1			20.0			20.0	21.0
Total Split (s)	44.0			102.0			58.0	38.0
Total Split (%)	31.4%			72.9%			41%	27%
Maximum Green (s)	38.9			97.0			52.9	34.0
Yellow Time (s)	3.0			3.3			3.0	3.0
All-Red Time (s)	2.1			1.7			2.1	1.0
Lost Time Adjust (s)	-0.1			0.0				
Total Lost Time (s)	5.0			5.0				
Lead/Lag	Lead						Lag	
Lead-Lag Optimize?								
Vehicle Extension (s)	1.0			1.0			4.0	0.2
Recall Mode	None			C-Max			C-Max	None
Walk Time (s)	7.0							7.0
Flash Dont Walk (s)	4.0							9.0
Pedestrian Calls (#/hr)	0							0
Act Effect Green (s)	57.0		73.0	124.0				

Lanes, Volumes, Timings
 15: NC 86 (Pittsboro St) & W. Cameron Avenue

09/01/2020



Lane Group	EBT	EBR	WBL	WBT	NBL	NBR	Ø1	Ø4
Actuated g/C Ratio	0.41		0.52	0.89				
v/c Ratio	0.77		0.38	0.26				
Control Delay	48.1		13.4	0.8				
Queue Delay	0.0		0.1	0.7				
Total Delay	48.1		13.5	1.6				
LOS	D		B	A				
Approach Delay	48.1			8.7				
Approach LOS	D			A				
Queue Length 50th (ft)	324		80	7				
Queue Length 95th (ft)	447		m113	m38				
Internal Link Dist (ft)	311			40	714			
Turn Bay Length (ft)			75					
Base Capacity (vph)	517		2063	1436				
Starvation Cap Reductn	0		515	734				
Spillback Cap Reductn	0		0	0				
Storage Cap Reductn	0		0	0				
Reduced v/c Ratio	0.77		0.37	0.53				

Intersection Summary

Area Type: CBD
 Cycle Length: 140
 Actuated Cycle Length: 140
 Offset: 104 (74%), Referenced to phase 1:WBL and 6:WBT, Start of Green
 Natural Cycle: 70
 Control Type: Actuated-Coordinated
 Maximum v/c Ratio: 0.77
 Intersection Signal Delay: 20.4
 Intersection LOS: C
 Intersection Capacity Utilization 52.2%
 ICU Level of Service A
 Analysis Period (min) 15
 m Volume for 95th percentile queue is metered by upstream signal.

Splits and Phases: 15: NC 86 (Pittsboro St) & W. Cameron Avenue



Lanes, Volumes, Timings

16: NC 86 (S. Columbia St) & W. Cameron Avenue/E. Cameron Avenue

09/01/2020



Lane Group	EBL	EBT	EBR	WBL	WBT	WBR	NBL	NBT	NBR	SBL	SBT	SBR
Lane Configurations												
Traffic Volume (vph)	20	122	0	0	166	51	220	664	59	119	0	504
Future Volume (vph)	20	122	0	0	166	51	220	664	59	119	0	504
Ideal Flow (vphpl)	1900	1900	1900	1900	1900	1900	1900	1900	1900	1900	1900	1900
Lane Width (ft)	11	12	12	12	12	12	10	10	10	11	11	12
Grade (%)		1%			-1%			1%			2%	
Storage Length (ft)	100		0	0		0	0		0	310		0
Storage Lanes	1		0	0		0	1		0	1		2
Taper Length (ft)	25			25			25			25		
Lane Util. Factor	1.00	1.00	1.00	1.00	1.00	1.00	0.91	0.91	0.95	1.00	1.00	0.88
Ped Bike Factor	0.86				0.93		0.68	0.94		0.79		0.60
Frt					0.968			0.988				0.850
Flt Protected	0.950						0.950	0.999		0.950		
Satd. Flow (prot)	1532	1668	0	0	1493	0	1295	2542	0	1453	0	2367
Flt Permitted	0.298						0.950	0.999		0.950		
Satd. Flow (perm)	411	1668	0	0	1493	0	884	2519	0	1148	0	1418
Right Turn on Red			No			No			No			No
Satd. Flow (RTOR)												
Link Speed (mph)		25			25			25			25	
Link Distance (ft)		273			989			826			981	
Travel Time (s)		10.7			57.6			22.5			26.8	
Confl. Peds. (#/hr)	157		172	172		157	111		248	248		111
Peak Hour Factor	0.91	0.91	0.91	0.90	0.90	0.90	0.87	0.87	0.87	0.85	0.85	0.85
Heavy Vehicles (%)	2%	2%	2%	4%	4%	4%	6%	6%	6%	7%	7%	7%
Adj. Flow (vph)	22	134	0	0	184	57	253	763	68	140	0	593
Shared Lane Traffic (%)							10%					
Lane Group Flow (vph)	22	134	0	0	241	0	228	856	0	140	0	593
Turn Type	Perm	NA			NA		Split	NA		Prot		Prot
Protected Phases		4			8		2	2		1		1
Permitted Phases	4									1		1
Detector Phase	4	4			8		2	2		1		1
Switch Phase												
Minimum Initial (s)	10.0	10.0			10.0		7.0	7.0		7.0		7.0
Minimum Split (s)	24.0	24.0			31.0		18.0	18.0		26.0		26.0
Total Split (s)	31.0	31.0			31.0		47.0	47.0		34.0		34.0
Total Split (%)	22.1%	22.1%			22.1%		33.6%	33.6%		24.3%		24.3%
Maximum Green (s)	24.8	24.8			24.8		41.1	41.1		28.4		28.4
Yellow Time (s)	3.2	3.2			3.2		3.1	3.1		3.0		3.0
All-Red Time (s)	3.0	3.0			3.0		2.8	2.8		2.6		2.6
Lost Time Adjust (s)	-1.2	-1.2			-1.2		-0.9	-0.9		-0.6		-0.6
Total Lost Time (s)	5.0	5.0			5.0		5.0	5.0		5.0		5.0
Lead/Lag							Lag	Lag		Lead		Lead
Lead-Lag Optimize?												
Vehicle Extension (s)	2.0	2.0			2.0		4.0	4.0		4.0		4.0
Recall Mode	None	None			None		C-Max	C-Max		None		None
Walk Time (s)	7.0	7.0			7.0		7.0	7.0		7.0		7.0
Flash Dont Walk (s)	10.0	10.0			17.0		5.0	5.0		13.0		13.0
Pedestrian Calls (#/hr)	0	0			0		0	0		0		0
Act Effect Green (s)	25.0	25.0			25.0		47.1	47.1		53.0		53.0

Lanes, Volumes, Timings

16: NC 86 (S. Columbia St) & W. Cameron Avenue/E. Cameron Avenue

09/01/2020

Lane Group	Ø9
Lane Configurations	
Traffic Volume (vph)	
Future Volume (vph)	
Ideal Flow (vphpl)	
Lane Width (ft)	
Grade (%)	
Storage Length (ft)	
Storage Lanes	
Taper Length (ft)	
Lane Util. Factor	
Ped Bike Factor	
Flt	
Flt Protected	
Satd. Flow (prot)	
Flt Permitted	
Satd. Flow (perm)	
Right Turn on Red	
Satd. Flow (RTOR)	
Link Speed (mph)	
Link Distance (ft)	
Travel Time (s)	
Confl. Peds. (#/hr)	
Peak Hour Factor	
Heavy Vehicles (%)	
Adj. Flow (vph)	
Shared Lane Traffic (%)	
Lane Group Flow (vph)	
Turn Type	
Protected Phases	9
Permitted Phases	
Detector Phase	
Switch Phase	
Minimum Initial (s)	7.0
Minimum Split (s)	28.0
Total Split (s)	28.0
Total Split (%)	20%
Maximum Green (s)	24.0
Yellow Time (s)	3.0
All-Red Time (s)	1.0
Lost Time Adjust (s)	
Total Lost Time (s)	
Lead/Lag	
Lead-Lag Optimize?	
Vehicle Extension (s)	0.2
Recall Mode	None
Walk Time (s)	7.0
Flash Dont Walk (s)	17.0
Pedestrian Calls (#/hr)	0
Act Effect Green (s)	

Lanes, Volumes, Timings

16: NC 86 (S. Columbia St) & W. Cameron Avenue/E. Cameron Avenue

09/01/2020



Lane Group	EBL	EBT	EBR	WBL	WBT	WBR	NBL	NBT	NBR	SBL	SBT	SBR
Actuated g/C Ratio	0.18	0.18			0.18		0.34	0.34		0.38		0.38
v/c Ratio	0.30	0.45			0.91		0.52	1.00		0.26		0.66
Control Delay	23.8	20.4			91.7		42.1	77.3		17.9		27.1
Queue Delay	0.0	0.0			0.0		0.0	0.0		0.0		0.0
Total Delay	23.8	20.4			91.7		42.1	77.3		17.9		27.1
LOS	C	C			F		D	E		B		C
Approach Delay		20.9			91.7			69.9				25.4
Approach LOS		C			F			E				C
Queue Length 50th (ft)	11	74			216		178	414		80		259
Queue Length 95th (ft)	m15	m102			#367		265	#542		m105		326
Internal Link Dist (ft)		193			909			746				901
Turn Bay Length (ft)	100									310		
Base Capacity (vph)	76	309			277		435	854		549		895
Starvation Cap Reductn	0	0			0		0	0		0		0
Spillback Cap Reductn	0	0			0		0	0		0		0
Storage Cap Reductn	0	0			0		0	0		0		0
Reduced v/c Ratio	0.29	0.43			0.87		0.52	1.00		0.26		0.66

Intersection Summary

Area Type: CBD
 Cycle Length: 140
 Actuated Cycle Length: 140
 Offset: 23 (16%), Referenced to phase 2:NBTL, Start of Green
 Natural Cycle: 145
 Control Type: Actuated-Coordinated
 Maximum v/c Ratio: 1.00
 Intersection Signal Delay: 54.1 Intersection LOS: D
 Intersection Capacity Utilization 79.5% ICU Level of Service D
 Analysis Period (min) 15
 # 95th percentile volume exceeds capacity, queue may be longer.
 Queue shown is maximum after two cycles.
 m Volume for 95th percentile queue is metered by upstream signal.

Splits and Phases: 16: NC 86 (S. Columbia St) & W. Cameron Avenue/E. Cameron Avenue

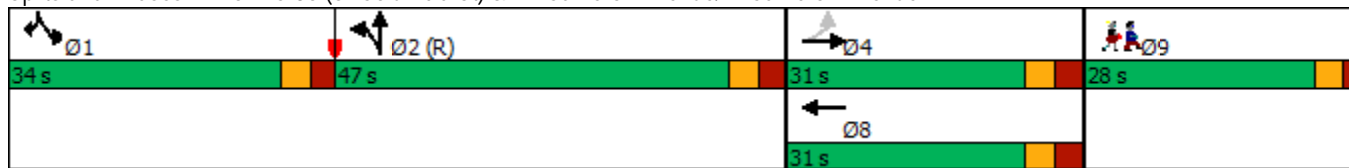

Lanes, Volumes, Timings

16: NC 86 (S. Columbia St) & W. Cameron Avenue/E. Cameron Avenue

09/01/2020

Lane Group	Ø9
Actuated g/C Ratio	
v/c Ratio	
Control Delay	
Queue Delay	
Total Delay	
LOS	
Approach Delay	
Approach LOS	
Queue Length 50th (ft)	
Queue Length 95th (ft)	
Internal Link Dist (ft)	
Turn Bay Length (ft)	
Base Capacity (vph)	
Starvation Cap Reductn	
Spillback Cap Reductn	
Storage Cap Reductn	
Reduced v/c Ratio	
Intersection Summary	

Lanes, Volumes, Timings

17: Raleigh Street & E. Cameron Avenue/Country Club Road

09/01/2020



Lane Group	EBL	EBT	EBR	WBL	WBT	WBR	NBL	NBT	NBR	SBL	SBT	SBR
Lane Configurations		↕		↗	↘		↗	↘		↗	↘	
Traffic Volume (vph)	27	162	47	35	129	179	55	92	61	262	186	53
Future Volume (vph)	27	162	47	35	129	179	55	92	61	262	186	53
Ideal Flow (vphpl)	1900	1900	1900	1900	1900	1900	1900	1900	1900	1900	1900	1900
Grade (%)		-3%			3%			-2%				1%
Storage Length (ft)	0		0	150		0	125		0	75		0
Storage Lanes	0		0	1		0	1		0	1		0
Taper Length (ft)	25			25			25			25		
Lane Util. Factor	1.00	1.00	1.00	1.00	1.00	1.00	1.00	1.00	1.00	1.00	1.00	1.00
Ped Bike Factor		0.94			0.88			0.88		0.82	0.88	
Frt		0.973			0.913			0.940			0.967	
Flt Protected		0.994		0.950			0.950			0.950		
Satd. Flow (prot)	0	1571	0	1569	1329	0	1563	1358	0	1585	1419	0
Flt Permitted		0.924		0.374			0.586			0.450		
Satd. Flow (perm)	0	1441	0	618	1329	0	964	1358	0	613	1419	0
Right Turn on Red			No			No			No			No
Satd. Flow (RTOR)												
Link Speed (mph)		25			25			25				25
Link Distance (ft)		598			651			409				995
Travel Time (s)		16.3			17.8			11.2				27.1
Confl. Peds. (#/hr)	39		37	37		39	107		60	60		107
Peak Hour Factor	0.75	0.75	0.75	0.89	0.89	0.89	0.89	0.89	0.89	0.84	0.84	0.84
Heavy Vehicles (%)	2%	2%	2%	2%	2%	2%	5%	5%	5%	2%	2%	2%
Adj. Flow (vph)	36	216	63	39	145	201	62	103	69	312	221	63
Shared Lane Traffic (%)												
Lane Group Flow (vph)	0	315	0	39	346	0	62	172	0	312	284	0
Turn Type	Perm	NA		pm+pt	NA		pm+pt	NA		pm+pt	NA	
Protected Phases		2		1	6		3	8		7	4	
Permitted Phases	2			6			8			4		
Detector Phase	2	2		1	6		3	8		7	4	
Switch Phase												
Minimum Initial (s)	10.0	10.0		7.0	10.0		7.0	7.0		7.0	7.0	
Minimum Split (s)	18.0	18.0		13.0	19.0		13.0	19.0		12.0	16.0	
Total Split (s)	50.0	50.0		20.0	70.0		20.0	35.0		20.0	35.0	
Total Split (%)	40.0%	40.0%		16.0%	56.0%		16.0%	28.0%		16.0%	28.0%	
Maximum Green (s)	43.9	43.9		14.4	64.4		14.7	29.7		15.1	29.9	
Yellow Time (s)	3.3	3.3		3.0	3.1		3.0	3.1		3.0	3.1	
All-Red Time (s)	2.8	2.8		2.6	2.5		2.3	2.2		1.9	2.0	
Lost Time Adjust (s)		-1.1		-0.6	-0.6		-0.3	-0.3		0.1	-0.1	
Total Lost Time (s)		5.0		5.0	5.0		5.0	5.0		5.0	5.0	
Lead/Lag	Lag	Lag		Lead			Lead	Lag		Lead	Lag	
Lead-Lag Optimize?	Yes	Yes		Yes			Yes	Yes		Yes	Yes	
Vehicle Extension (s)	2.0	2.0		2.0	2.0		2.0	2.0		2.0	2.0	
Recall Mode	None	None		None	None		None	None		None	None	
Walk Time (s)	4.0	4.0			4.0			4.0			4.0	
Flash Dont Walk (s)	7.0	7.0			9.0			9.0			6.0	
Pedestrian Calls (#/hr)	0	0			0			0			0	
Act Effect Green (s)		24.4		30.8	30.8		23.9	15.6		36.5	26.7	
Actuated g/C Ratio		0.31		0.39	0.39		0.31	0.20		0.47	0.34	

Lanes, Volumes, Timings

17: Raleigh Street & E. Cameron Avenue/Country Club Road

09/01/2020



Lane Group	EBL	EBT	EBR	WBL	WBT	WBR	NBL	NBT	NBR	SBL	SBT	SBR
v/c Ratio		0.70		0.11	0.66		0.17	0.64		0.65	0.59	
Control Delay		35.1		15.1	25.8		17.6	43.4		25.6	32.9	
Queue Delay		0.0		0.0	0.0		0.0	0.0		0.0	0.0	
Total Delay		35.1		15.1	25.8		17.6	43.4		25.6	32.9	
LOS		D		B	C		B	D		C	C	
Approach Delay		35.1			24.7			36.5			29.1	
Approach LOS		D			C			D			C	
Queue Length 50th (ft)		146		11	128		19	84		111	132	
Queue Length 95th (ft)		213		32	248		51	172		#213	248	
Internal Link Dist (ft)		518			571			329			915	
Turn Bay Length (ft)				150			125			75		
Base Capacity (vph)		904		448	1088		518	568		489	596	
Starvation Cap Reductn		0		0	0		0	0		0	0	
Spillback Cap Reductn		0		0	0		0	0		0	0	
Storage Cap Reductn		0		0	0		0	0		0	0	
Reduced v/c Ratio		0.35		0.09	0.32		0.12	0.30		0.64	0.48	

Intersection Summary

Area Type: CBD
 Cycle Length: 125
 Actuated Cycle Length: 78.2
 Natural Cycle: 70
 Control Type: Actuated-Uncoordinated
 Maximum v/c Ratio: 0.70
 Intersection Signal Delay: 30.4
 Intersection LOS: C
 Intersection Capacity Utilization 79.1%
 ICU Level of Service D
 Analysis Period (min) 15
 # 95th percentile volume exceeds capacity, queue may be longer.
 Queue shown is maximum after two cycles.

Splits and Phases: 17: Raleigh Street & E. Cameron Avenue/Country Club Road





2023 Without Office Building Site

Lanes, Volumes, Timings
1: Church Street & W. Rosemary Street

09/01/2020



Lane Group	EBL	EBT	EBR	WBL	WBT	WBR	NBL	NBT	NBR	SBL	SBT	SBR
Lane Configurations		↕			↕			↕			↕	
Traffic Volume (vph)	14	292	21	32	304	15	33	24	40	27	39	11
Future Volume (vph)	14	292	21	32	304	15	33	24	40	27	39	11
Ideal Flow (vphpl)	1900	1900	1900	1900	1900	1900	1900	1900	1900	1900	1900	1900
Lane Width (ft)	12	14	12	12	14	12	12	12	12	12	12	12
Grade (%)		1%			-1%			0%			0%	
Lane Util. Factor	1.00	1.00	1.00	1.00	1.00	1.00	1.00	1.00	1.00	1.00	1.00	1.00
Ped Bike Factor		0.99			0.99			0.95			0.97	
Frt		0.991			0.994			0.944			0.981	
Flt Protected		0.998			0.995			0.983			0.983	
Satd. Flow (prot)	0	1734	0	0	1737	0	0	1501	0	0	1602	0
Flt Permitted		0.982			0.950			0.884			0.873	
Satd. Flow (perm)	0	1705	0	0	1655	0	0	1332	0	0	1395	0
Right Turn on Red			No			No			No			No
Satd. Flow (RTOR)												
Link Speed (mph)		20			20			25			25	
Link Distance (ft)		964			757			379			430	
Travel Time (s)		32.9			25.8			10.3			11.7	
Confl. Peds. (#/hr)	20		17	17		20	21		31	31		21
Peak Hour Factor	0.86	0.86	0.86	0.89	0.89	0.89	0.84	0.84	0.84	0.72	0.72	0.72
Heavy Vehicles (%)	3%	3%	3%	4%	4%	4%	2%	2%	2%	2%	2%	2%
Adj. Flow (vph)	16	340	24	36	342	17	39	29	48	38	54	15
Shared Lane Traffic (%)												
Lane Group Flow (vph)	0	380	0	0	395	0	0	116	0	0	107	0
Turn Type	Perm	NA		Perm	NA		Perm	NA		Perm	NA	
Protected Phases		2			6			8			4	
Permitted Phases	2			6			8			4		
Detector Phase	2	2		6	6		8	8		4	4	
Switch Phase												
Minimum Initial (s)	10.0	10.0		10.0	10.0		7.0	7.0		7.0	7.0	
Minimum Split (s)	19.0	19.0		20.0	20.0		19.0	19.0		19.0	19.0	
Total Split (s)	38.0	38.0		38.0	38.0		22.0	22.0		22.0	22.0	
Total Split (%)	63.3%	63.3%		63.3%	63.3%		36.7%	36.7%		36.7%	36.7%	
Maximum Green (s)	33.5	33.5		33.4	33.4		17.1	17.1		17.1	17.1	
Yellow Time (s)	3.1	3.1		3.1	3.1		3.2	3.2		3.2	3.2	
All-Red Time (s)	1.4	1.4		1.5	1.5		1.7	1.7		1.7	1.7	
Lost Time Adjust (s)		0.5			0.4			0.1			0.1	
Total Lost Time (s)		5.0			5.0			5.0			5.0	
Lead/Lag												
Lead-Lag Optimize?												
Vehicle Extension (s)	3.0	3.0		3.0	3.0		3.0	3.0		3.0	3.0	
Recall Mode	C-Max	C-Max		C-Max	C-Max		None	None		None	None	
Walk Time (s)	4.0	4.0		4.0	4.0		4.0	4.0		4.0	4.0	
Flash Dont Walk (s)	5.0	5.0		6.0	6.0		10.0	10.0		10.0	10.0	
Pedestrian Calls (#/hr)	0	0		0	0		0	0		0	0	
Act Effct Green (s)		42.8			42.8			10.6			10.6	
Actuated g/C Ratio		0.71			0.71			0.18			0.18	
v/c Ratio		0.31			0.34			0.49			0.43	
Control Delay		5.8			3.5			24.9			26.6	

Lanes, Volumes, Timings
 1: Church Street & W. Rosemary Street

09/01/2020



Lane Group	EBL	EBT	EBR	WBL	WBT	WBR	NBL	NBT	NBR	SBL	SBT	SBR
Queue Delay		0.0			0.0			0.0			0.0	
Total Delay		5.8			3.5			24.9			26.6	
LOS		A			A			C			C	
Approach Delay		5.8			3.5			24.9			26.6	
Approach LOS		A			A			C			C	
Queue Length 50th (ft)		49			17			38			35	
Queue Length 95th (ft)		104			77			54			53	
Internal Link Dist (ft)		884			677			299			350	
Turn Bay Length (ft)												
Base Capacity (vph)		1215			1179			377			395	
Starvation Cap Reductn		0			0			0			0	
Spillback Cap Reductn		0			0			0			0	
Storage Cap Reductn		0			0			0			0	
Reduced v/c Ratio		0.31			0.34			0.31			0.27	

Intersection Summary

Area Type:	CBD
Cycle Length:	60
Actuated Cycle Length:	60
Offset:	7 (12%), Referenced to phase 2:EBTL and 6:WBTL, Start of Green
Natural Cycle:	40
Control Type:	Actuated-Coordinated
Maximum v/c Ratio:	0.49
Intersection Signal Delay:	9.4
Intersection LOS:	A
Intersection Capacity Utilization:	51.7%
ICU Level of Service:	A
Analysis Period (min):	15

Splits and Phases: 1: Church Street & W. Rosemary Street

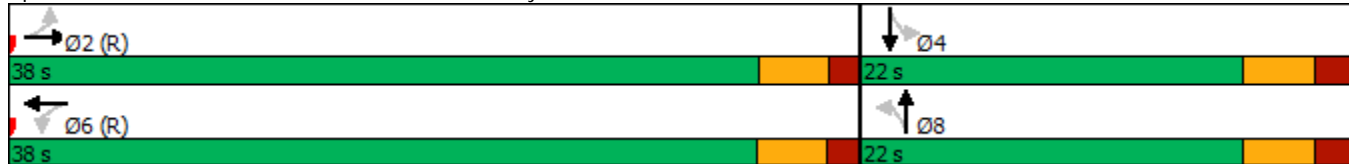

Lanes, Volumes, Timings

2: NC 86 (N. Columbia St) & W. Rosemary Street/E. Rosemary Street

09/01/2020



Lane Group	EBL	EBT	EBR	WBL	WBT	WBR	NBL	NBT	NBR	SBL	SBT	SBR
Lane Configurations												
Traffic Volume (vph)	152	212	21	16	169	28	22	312	81	48	565	178
Future Volume (vph)	152	212	21	16	169	28	22	312	81	48	565	178
Ideal Flow (vphpl)	1900	1900	1900	1900	1900	1900	1900	1900	1900	1900	1900	1900
Lane Width (ft)	9	12	13	12	12	12	9	10	12	12	9	11
Grade (%)		1%			1%			-2%			8%	
Storage Length (ft)	100		0	150		0	75		0	150		400
Storage Lanes	1		0	1		0	1		0	1		1
Taper Length (ft)	25			25			25			25		
Lane Util. Factor	1.00	1.00	1.00	1.00	1.00	1.00	1.00	0.95	0.95	1.00	0.95	1.00
Ped Bike Factor	0.99	1.00		0.98	1.00		0.98	0.97		0.95		0.91
Frt		0.987			0.979			0.969				0.850
Flt Protected	0.950			0.950			0.950			0.950		
Satd. Flow (prot)	1426	1641	0	1585	1627	0	1355	2646	0	1485	2673	1285
Flt Permitted	0.285			0.593			0.349			0.455		
Satd. Flow (perm)	424	1641	0	974	1627	0	489	2646	0	673	2673	1169
Right Turn on Red			No			No			No			No
Satd. Flow (RTOR)												
Link Speed (mph)		20			20			25			25	
Link Distance (ft)		757			461			353			476	
Travel Time (s)		25.8			15.7			9.6			13.0	
Confl. Peds. (#/hr)	12		16	16		12	19		34	34		19
Peak Hour Factor	0.86	0.86	0.86	0.90	0.90	0.90	0.90	0.90	0.90	0.88	0.88	0.88
Heavy Vehicles (%)	2%	2%	2%	2%	2%	2%	9%	9%	9%	5%	5%	5%
Adj. Flow (vph)	177	247	24	18	188	31	24	347	90	55	642	202
Shared Lane Traffic (%)												
Lane Group Flow (vph)	177	271	0	18	219	0	24	437	0	55	642	202
Turn Type	pm+pt	NA		Perm	NA		pm+pt	NA		pm+pt	NA	pm+ov
Protected Phases	7	4			8		5	2		1	6	7
Permitted Phases	4			8			2			6		6
Detector Phase	7	4		8	8		5	2		1	6	7
Switch Phase												
Minimum Initial (s)	7.0	7.0		7.0	7.0		7.0	10.0		7.0	10.0	7.0
Minimum Split (s)	13.0	31.0		32.0	32.0		13.0	23.0		13.0	22.0	13.0
Total Split (s)	23.0	57.0		34.0	34.0		13.0	50.0		13.0	50.0	23.0
Total Split (%)	19.2%	47.5%		28.3%	28.3%		10.8%	41.7%		10.8%	41.7%	19.2%
Maximum Green (s)	17.2	51.0		28.0	28.0		7.2	44.2		7.9	44.2	17.2
Yellow Time (s)	3.0	3.2		3.2	3.2		3.0	3.3		3.0	3.3	3.0
All-Red Time (s)	2.8	2.8		2.8	2.8		2.8	2.5		2.1	2.5	2.8
Lost Time Adjust (s)	-0.8	-1.0		-1.0	-1.0		-1.0	-0.8		-0.1	-0.8	-0.8
Total Lost Time (s)	5.0	5.0		5.0	5.0		4.8	5.0		5.0	5.0	5.0
Lead/Lag	Lead			Lag	Lag		Lead	Lag		Lead	Lag	Lead
Lead-Lag Optimize?												
Vehicle Extension (s)	1.0	1.0		1.0	1.0		1.0	3.0		1.0	3.0	1.0
Recall Mode	None	None		None	None		None	C-Max		None	C-Max	None
Walk Time (s)		7.0		7.0	7.0			7.0			7.0	
Flash Dont Walk (s)		18.0		19.0	19.0			10.0			9.0	
Pedestrian Calls (#/hr)		0		0	0			0			0	
Act Effect Green (s)	41.6	41.6		20.6	20.6		65.1	58.5		65.2	60.7	76.7

Lanes, Volumes, Timings

2: NC 86 (N. Columbia St) & W. Rosemary Street/E. Rosemary Street

09/01/2020



Lane Group	EBL	EBT	EBR	WBL	WBT	WBR	NBL	NBT	NBR	SBL	SBT	SBR
Actuated g/C Ratio	0.35	0.35		0.17	0.17		0.54	0.49		0.54	0.51	0.64
v/c Ratio	0.63	0.48		0.11	0.78		0.07	0.34		0.13	0.48	0.27
Control Delay	39.2	33.8		35.6	58.1		12.4	14.8		12.9	17.0	6.7
Queue Delay	0.0	0.0		0.0	0.0		0.0	0.1		0.0	0.0	0.0
Total Delay	39.2	33.8		35.6	58.1		12.4	15.0		12.9	17.1	6.7
LOS	D	C		D	E		B	B		B	B	A
Approach Delay		35.9			56.4			14.8			14.5	
Approach LOS		D			E			B			B	
Queue Length 50th (ft)	106	169		10	136		5	60		16	118	29
Queue Length 95th (ft)	145	229		29	199		m14	106		30	141	45
Internal Link Dist (ft)		677			381			273			396	
Turn Bay Length (ft)	100			150			75			150		400
Base Capacity (vph)	297	711		235	393		324	1289		422	1351	783
Starvation Cap Reductn	0	0		0	0		0	181		0	0	0
Spillback Cap Reductn	0	0		0	0		0	0		0	21	0
Storage Cap Reductn	0	0		0	0		0	0		0	0	0
Reduced v/c Ratio	0.60	0.38		0.08	0.56		0.07	0.39		0.13	0.48	0.26

Intersection Summary

Area Type: CBD
 Cycle Length: 120
 Actuated Cycle Length: 120
 Offset: 41 (34%), Referenced to phase 2:NBTL and 6:SBTL, Start of Green
 Natural Cycle: 85
 Control Type: Actuated-Coordinated
 Maximum v/c Ratio: 0.78
 Intersection Signal Delay: 24.1 Intersection LOS: C
 Intersection Capacity Utilization 64.2% ICU Level of Service C
 Analysis Period (min) 15
 m Volume for 95th percentile queue is metered by upstream signal.

Splits and Phases: 2: NC 86 (N. Columbia St) & W. Rosemary Street/E. Rosemary Street

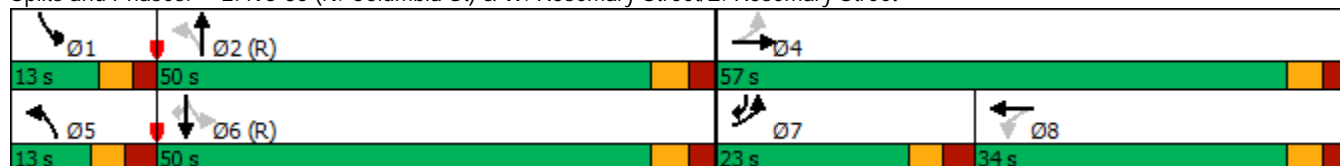

Lanes, Volumes, Timings
6: Henderson Street & E. Rosemary Street

09/01/2020



Lane Group	EBL	EBT	EBR	WBL	WBT	WBR	NBL	NBT	NBR	SBL	SBT	SBR
Lane Configurations												
Traffic Volume (vph)	5	139	61	8	240	16	59	6	8	9	17	5
Future Volume (vph)	5	139	61	8	240	16	59	6	8	9	17	5
Ideal Flow (vphpl)	1900	1900	1900	1900	1900	1900	1900	1900	1900	1900	1900	1900
Grade (%)		0%			0%			0%				3%
Storage Length (ft)	85		0	0		0	0		0	0		0
Storage Lanes	1		0	0		0	0		0	0		0
Taper Length (ft)	25			25			25			25		
Lane Util. Factor	1.00	1.00	1.00	1.00	1.00	1.00	1.00	1.00	1.00	1.00	1.00	1.00
Ped Bike Factor	0.99	0.99			1.00			0.95				0.98
Frt		0.954			0.992			0.986				0.979
Flt Protected	0.950				0.998			0.961				0.986
Satd. Flow (prot)	1593	1582	0	0	1657	0	0	1561	0	0	1561	0
Flt Permitted	0.594				0.992			0.736				0.885
Satd. Flow (perm)	990	1582	0	0	1646	0	0	1149	0	0	1382	0
Right Turn on Red			No			No			No			No
Satd. Flow (RTOR)												
Link Speed (mph)		20			20			20				20
Link Distance (ft)		496			1195			366				450
Travel Time (s)		16.9			40.7			12.5				15.3
Confl. Peds. (#/hr)	4		6	6		4	22		23	23		22
Peak Hour Factor	0.89	0.89	0.89	0.75	0.75	0.75	0.87	0.87	0.87	0.68	0.68	0.68
Heavy Vehicles (%)	2%	2%	2%	2%	2%	2%	3%	3%	3%	3%	3%	3%
Adj. Flow (vph)	6	156	69	11	320	21	68	7	9	13	25	7
Shared Lane Traffic (%)												
Lane Group Flow (vph)	6	225	0	0	352	0	0	84	0	0	45	0
Turn Type	Perm	NA		Perm	NA		Perm	NA		Perm	NA	
Protected Phases		2			2			4				4
Permitted Phases	2			2			4			4		
Detector Phase	2	2		2	2		4	4		4	4	
Switch Phase												
Minimum Initial (s)	11.0	11.0		11.0	11.0		8.0	8.0		8.0	8.0	
Minimum Split (s)	15.9	15.9		15.9	15.9		17.8	17.8		17.8	17.8	
Total Split (s)	40.0	40.0		40.0	40.0		20.0	20.0		20.0	20.0	
Total Split (%)	66.7%	66.7%		66.7%	66.7%		33.3%	33.3%		33.3%	33.3%	
Maximum Green (s)	35.1	35.1		35.1	35.1		15.2	15.2		15.2	15.2	
Yellow Time (s)	3.3	3.3		3.3	3.3		3.3	3.3		3.3	3.3	
All-Red Time (s)	1.6	1.6		1.6	1.6		1.5	1.5		1.5	1.5	
Lost Time Adjust (s)	0.1	0.1			0.1			0.2				0.2
Total Lost Time (s)	5.0	5.0			5.0			5.0				5.0
Lead/Lag												
Lead-Lag Optimize?												
Vehicle Extension (s)	2.0	2.0		2.0	2.0		2.0	2.0		2.0	2.0	
Recall Mode	C-Max	C-Max		C-Max	C-Max		None	None		None	None	
Walk Time (s)	4.0	4.0		4.0	4.0		4.0	4.0		4.0	4.0	
Flash Dont Walk (s)	7.0	7.0		7.0	7.0		9.0	9.0		9.0	9.0	
Pedestrian Calls (#/hr)	0	0		0	0		0	0		0	0	
Act Effct Green (s)	44.1	44.1			44.1			9.4				9.4
Actuated g/C Ratio	0.74	0.74			0.74			0.16				0.16

Lanes, Volumes, Timings
 6: Henderson Street & E. Rosemary Street

09/01/2020



Lane Group	EBL	EBT	EBR	WBL	WBT	WBR	NBL	NBT	NBR	SBL	SBT	SBR
v/c Ratio	0.01	0.19			0.29			0.47				0.21
Control Delay	6.0	5.6			5.6			27.6				23.5
Queue Delay	0.0	0.0			0.0			0.0				0.0
Total Delay	6.0	5.6			5.6			27.6				23.5
LOS	A	A			A			C				C
Approach Delay		5.7			5.6			27.6				23.5
Approach LOS		A			A			C				C
Queue Length 50th (ft)	1	45			73			42				15
Queue Length 95th (ft)	m4	94			83			77				27
Internal Link Dist (ft)		416			1115			286				370
Turn Bay Length (ft)	85											
Base Capacity (vph)	728	1163			1210			287				345
Starvation Cap Reductn	0	0			0			0				0
Spillback Cap Reductn	0	0			0			0				0
Storage Cap Reductn	0	0			0			0				0
Reduced v/c Ratio	0.01	0.19			0.29			0.29				0.13

Intersection Summary

Area Type: CBD
 Cycle Length: 60
 Actuated Cycle Length: 60
 Offset: 38 (63%), Referenced to phase 2:EBWB, Start of Green
 Natural Cycle: 40
 Control Type: Actuated-Coordinated
 Maximum v/c Ratio: 0.47
 Intersection Signal Delay: 9.3
 Intersection Capacity Utilization 41.7%
 Analysis Period (min) 15
 Intersection LOS: A
 ICU Level of Service A

m Volume for 95th percentile queue is metered by upstream signal.

Splits and Phases: 6: Henderson Street & E. Rosemary Street



Lanes, Volumes, Timings

7: Hillsborough Street & E. Rosemary Street

09/01/2020



Lane Group	EBL	EBT	EBR	WBL	WBT	WBR	NBL	NBT	NBR	SBL	SBT	SBR
Lane Configurations		↕			↕		↕	↕		↕	↕	
Traffic Volume (vph)	6	58	69	0	111	12	136	143	6	21	360	32
Future Volume (vph)	6	58	69	0	111	12	136	143	6	21	360	32
Ideal Flow (vphpl)	1900	1900	1900	1900	1900	1900	1900	1900	1900	1900	1900	1900
Storage Length (ft)	0		0	0		0	100		0	100		0
Storage Lanes	0		0	0		0	1		0	1		0
Taper Length (ft)	25			25			25			25		
Lane Util. Factor	1.00	1.00	1.00	1.00	1.00	1.00	1.00	1.00	1.00	1.00	1.00	1.00
Ped Bike Factor		0.99			1.00			1.00		1.00	1.00	
Frt		0.930			0.987			0.994			0.988	
Flt Protected		0.998					0.950			0.950		
Satd. Flow (prot)	0	1706	0	0	1832	0	1752	1832	0	1752	1814	0
Flt Permitted		0.979					0.374			0.656		
Satd. Flow (perm)	0	1672	0	0	1832	0	690	1832	0	1204	1814	0
Right Turn on Red			No			No			No			No
Satd. Flow (RTOR)												
Link Speed (mph)		20			20			25			25	
Link Distance (ft)		1195			527			363			726	
Travel Time (s)		40.7			18.0			9.9			19.8	
Confl. Peds. (#/hr)	6		3	3		6	13		2	2		13
Peak Hour Factor	0.82	0.82	0.82	0.71	0.71	0.71	0.93	0.93	0.93	0.90	0.90	0.90
Heavy Vehicles (%)	2%	2%	2%	2%	2%	2%	3%	3%	3%	3%	3%	3%
Adj. Flow (vph)	7	71	84	0	156	17	146	154	6	23	400	36
Shared Lane Traffic (%)												
Lane Group Flow (vph)	0	162	0	0	173	0	146	160	0	23	436	0
Turn Type	Perm	NA			NA		pm+pt	NA		Perm	NA	
Protected Phases		4			8		5	2			6	
Permitted Phases	4			8			2			6		
Detector Phase	4	4		8	8		5	2		6	6	
Switch Phase												
Minimum Initial (s)	7.0	7.0		7.0	7.0		7.0	10.0		10.0	10.0	
Minimum Split (s)	20.0	20.0		17.0	17.0		12.0	15.0		15.0	15.0	
Total Split (s)	20.0	20.0		20.0	20.0		12.0	40.0		28.0	28.0	
Total Split (%)	33.3%	33.3%		33.3%	33.3%		20.0%	66.7%		46.7%	46.7%	
Maximum Green (s)	15.1	15.1		15.0	15.0		7.2	35.2		23.2	23.2	
Yellow Time (s)	3.0	3.0		3.3	3.3		3.0	3.3		3.1	3.1	
All-Red Time (s)	1.9	1.9		1.7	1.7		1.8	1.5		1.7	1.7	
Lost Time Adjust (s)		0.1			0.0		0.2	0.2		0.2	0.2	
Total Lost Time (s)		5.0			5.0		5.0	5.0		5.0	5.0	
Lead/Lag							Lead			Lag	Lag	
Lead-Lag Optimize?							Yes			Yes	Yes	
Vehicle Extension (s)	2.0	2.0		2.0	2.0		2.0	2.0		2.0	2.0	
Recall Mode	None	None		None	None		None	C-Max		C-Max	C-Max	
Walk Time (s)	4.0	4.0		4.0	4.0			4.0		4.0	4.0	
Flash Dont Walk (s)	11.0	11.0		8.0	8.0			6.0		6.0	6.0	
Pedestrian Calls (#/hr)	0	0		0	0			0		0	0	
Act Effct Green (s)		10.3			10.3		42.1	43.1		33.5	33.5	
Actuated g/C Ratio		0.17			0.17		0.70	0.72		0.56	0.56	
v/c Ratio		0.57			0.55		0.24	0.12		0.03	0.43	

Lanes, Volumes, Timings
 7: Hillsborough Street & E. Rosemary Street

09/01/2020



Lane Group	EBL	EBT	EBR	WBL	WBT	WBR	NBL	NBT	NBR	SBL	SBT	SBR
Control Delay		29.2			29.0		3.1	2.4		10.9	13.5	
Queue Delay		0.0			0.0		0.0	0.0		0.0	0.0	
Total Delay		29.2			29.0		3.1	2.4		10.9	13.5	
LOS		C			C		A	A		B	B	
Approach Delay		29.2			29.0			2.7				13.3
Approach LOS		C			C			A				B
Queue Length 50th (ft)		61			58		8	9		4	103	
Queue Length 95th (ft)		91			77		21	22		17	209	
Internal Link Dist (ft)		1115			447			283			646	
Turn Bay Length (ft)							100			100		
Base Capacity (vph)		418			458		610	1316		671	1011	
Starvation Cap Reductn		0			0		0	0		0	0	
Spillback Cap Reductn		0			0		0	0		0	0	
Storage Cap Reductn		0			0		0	0		0	0	
Reduced v/c Ratio		0.39			0.38		0.24	0.12		0.03	0.43	

Intersection Summary

Area Type:	Other
Cycle Length:	60
Actuated Cycle Length:	60
Offset:	14 (23%), Referenced to phase 2:NBTL and 6:SBTL, Start of Green
Natural Cycle:	55
Control Type:	Actuated-Coordinated
Maximum v/c Ratio:	0.57
Intersection Signal Delay:	15.2
Intersection LOS:	B
Intersection Capacity Utilization:	53.7%
ICU Level of Service:	A
Analysis Period (min):	15

Splits and Phases: 7: Hillsborough Street & E. Rosemary Street



Lanes, Volumes, Timings

8: Carolina Square Driveway/Church Street & W. Franklin Street

09/01/2020



Lane Group	EBL	EBT	EBR	WBL	WBT	WBR	NBL	NBT	NBR	SBL	SBT	SBR
Lane Configurations												
Traffic Volume (vph)	49	339	23	10	250	43	2	5	10	20	20	49
Future Volume (vph)	49	339	23	10	250	43	2	5	10	20	20	49
Ideal Flow (vphpl)	1900	1900	1900	1900	1900	1900	1900	1900	1900	1900	1900	1900
Lane Width (ft)	10	10	16	10	10	10	12	12	12	12	12	12
Grade (%)		2%			-2%			-4%				-3%
Storage Length (ft)	150		0	200		0	0		100	0		0
Storage Lanes	1		0	1		0	0		1	0		0
Taper Length (ft)	25			25			25			25		
Lane Util. Factor	1.00	1.00	1.00	1.00	1.00	1.00	1.00	1.00	1.00	1.00	1.00	1.00
Ped Bike Factor	0.95	0.99		0.95	0.98			0.98	0.94		0.94	
Frt		0.991			0.978				0.850		0.926	
Flt Protected	0.950			0.950				0.985			0.989	
Satd. Flow (prot)	1430	1480	0	1431	1450	0	0	1621	1399	0	1431	0
Flt Permitted	0.550			0.500				0.884			0.918	
Satd. Flow (perm)	788	1480	0	717	1450	0	0	1423	1316	0	1317	0
Right Turn on Red			No			No			No			No
Satd. Flow (RTOR)												
Link Speed (mph)		20			20			20			25	
Link Distance (ft)		993			298			285			379	
Travel Time (s)		33.9			10.2			9.7			10.3	
Confl. Peds. (#/hr)	39		57	57		39	57		29	29		57
Peak Hour Factor	0.84	0.84	0.84	0.83	0.83	0.83	0.53	0.53	0.53	0.92	0.92	0.92
Heavy Vehicles (%)	5%	5%	5%	7%	7%	7%	6%	6%	6%	5%	5%	5%
Adj. Flow (vph)	58	404	27	12	301	52	4	9	19	22	22	53
Shared Lane Traffic (%)												
Lane Group Flow (vph)	58	431	0	12	353	0	0	13	19	0	97	0
Turn Type	Perm	NA		Perm	NA		Perm	NA	Perm	Perm	NA	
Protected Phases		2			6			8				4
Permitted Phases	2			6			8		8	4		
Detector Phase	2	2		6	6		8	8	8	4	4	
Switch Phase												
Minimum Initial (s)	10.0	10.0		10.0	10.0		7.0	7.0	7.0	7.0	7.0	
Minimum Split (s)	22.0	22.0		19.0	19.0		29.0	29.0	29.0	27.0	27.0	
Total Split (s)	31.0	31.0		31.0	31.0		29.0	29.0	29.0	29.0	29.0	
Total Split (%)	51.7%	51.7%		51.7%	51.7%		48.3%	48.3%	48.3%	48.3%	48.3%	
Maximum Green (s)	25.4	25.4		25.4	25.4		22.7	22.7	22.7	23.0	23.0	
Yellow Time (s)	3.3	3.3		3.3	3.3		3.1	3.1	3.1	3.4	3.4	
All-Red Time (s)	2.3	2.3		2.3	2.3		3.2	3.2	3.2	2.6	2.6	
Lost Time Adjust (s)	-0.6	-0.6		-0.6	-0.6		-1.3	-1.3	-1.3	-1.0	-1.0	
Total Lost Time (s)	5.0	5.0		5.0	5.0		5.0	5.0	5.0	5.0	5.0	
Lead/Lag												
Lead-Lag Optimize?												
Vehicle Extension (s)	3.0	3.0		3.0	3.0		2.0	2.0	2.0	2.0	2.0	
Recall Mode	C-Max	C-Max		C-Max	C-Max		None	None	None	None	None	
Walk Time (s)	7.0	7.0		7.0	7.0		7.0	7.0	7.0	7.0	7.0	
Flash Dont Walk (s)	9.0	9.0		6.0	6.0		15.0	15.0	15.0	14.0	14.0	
Pedestrian Calls (#/hr)	0	0		0	0		0	0	0	0	0	
Act Effect Green (s)	43.3	43.3		43.3	43.3		10.3	10.3	10.3	10.3	10.3	

Lanes, Volumes, Timings

8: Carolina Square Driveway/Church Street & W. Franklin Street

09/01/2020



Lane Group	EBL	EBT	EBR	WBL	WBT	WBR	NBL	NBT	NBR	SBL	SBT	SBR
Actuated g/C Ratio	0.72	0.72		0.72	0.72			0.17	0.17			0.17
v/c Ratio	0.10	0.40		0.02	0.34			0.05	0.08			0.43
Control Delay	5.0	6.5		2.1	3.9			19.7	20.2			25.4
Queue Delay	0.0	0.0		0.0	0.0			0.0	0.0			0.0
Total Delay	5.0	6.5		2.1	3.9			19.7	20.2			25.4
LOS	A	A		A	A			B	C			C
Approach Delay		6.3			3.9			20.0				25.4
Approach LOS		A			A			C				C
Queue Length 50th (ft)	6	58		2	81			4	6			36
Queue Length 95th (ft)	20	121		m1	27			9	12			56
Internal Link Dist (ft)		913			218			205				299
Turn Bay Length (ft)	150			200					100			
Base Capacity (vph)	568	1068		517	1046			569	526			526
Starvation Cap Reductn	0	0		0	0			0	0			0
Spillback Cap Reductn	0	0		0	0			0	0			0
Storage Cap Reductn	0	0		0	0			0	0			0
Reduced v/c Ratio	0.10	0.40		0.02	0.34			0.02	0.04			0.18

Intersection Summary

Area Type: CBD
 Cycle Length: 60
 Actuated Cycle Length: 60
 Offset: 42 (70%), Referenced to phase 2:EBTL and 6:WBTL, Start of Green
 Natural Cycle: 60
 Control Type: Actuated-Coordinated
 Maximum v/c Ratio: 0.43
 Intersection Signal Delay: 7.7 Intersection LOS: A
 Intersection Capacity Utilization 63.8% ICU Level of Service B
 Analysis Period (min) 15
 m Volume for 95th percentile queue is metered by upstream signal.

Splits and Phases: 8: Carolina Square Driveway/Church Street & W. Franklin Street

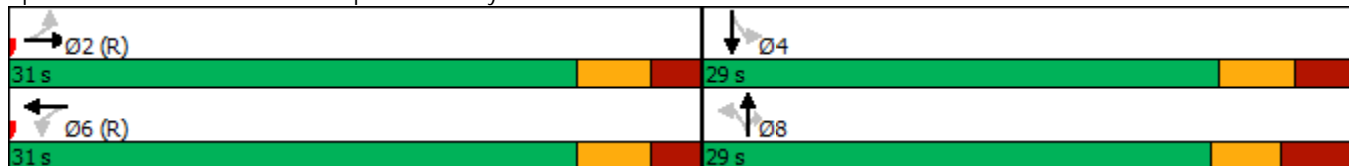

Lanes, Volumes, Timings

9: NC 86 (S. Columbia St)/NC 86 (N. Columbia St) & W. Franklin Street/E. Franklin Street 09/01/2020



Lane Group	EBL	EBT	EBR	WBL	WBT	WBR	NBL	NBT	NBR	SBL	SBT	SBR
Lane Configurations	↖	↗		↖	↗	↗	↖	↗		↖	↗	
Traffic Volume (vph)	71	286	29	66	278	46	30	320	88	36	465	80
Future Volume (vph)	71	286	29	66	278	46	30	320	88	36	465	80
Ideal Flow (vphpl)	1900	1900	1900	1900	1900	1900	1900	1900	1900	1900	1900	1900
Lane Width (ft)	9	12	13	10	10	13	9	10	10	9	9	11
Grade (%)		3%			1%			-2%			3%	
Storage Length (ft)	250		0	125		0	475		0	125		0
Storage Lanes	1		0	1		1	1		0	1		0
Taper Length (ft)	25			25			25			25		
Lane Util. Factor	1.00	0.95	0.95	1.00	1.00	1.00	1.00	0.95	0.95	1.00	0.95	0.95
Ped Bike Factor	0.87	0.99		0.95		0.79	0.97	0.96		0.91	0.99	
Frt		0.986				0.850		0.968			0.978	
Flt Protected	0.950			0.950			0.950			0.950		
Satd. Flow (prot)	1372	2980	0	1410	1484	1397	1342	2597	0	1346	2595	0
Flt Permitted	0.950			0.950			0.950			0.950		
Satd. Flow (perm)	1192	2980	0	1345	1484	1100	1299	2597	0	1229	2595	0
Right Turn on Red			No			No			No			No
Satd. Flow (RTOR)												
Link Speed (mph)		20			20			25			25	
Link Distance (ft)		457			941			981			353	
Travel Time (s)		15.6			32.1			26.8			9.6	
Confl. Peds. (#/hr)	125		49	49		125	29		98	98		29
Peak Hour Factor	0.80	0.80	0.80	0.87	0.87	0.87	0.93	0.93	0.93	0.85	0.85	0.85
Heavy Vehicles (%)	5%	5%	5%	7%	7%	7%	10%	10%	10%	7%	7%	7%
Adj. Flow (vph)	89	358	36	76	320	53	32	344	95	42	547	94
Shared Lane Traffic (%)												
Lane Group Flow (vph)	89	394	0	76	320	53	32	439	0	42	641	0
Turn Type	Prot	NA		Prot	NA	pm+ov	Prot	NA		Prot	NA	
Protected Phases	5	2		1	6	7	3	8		7	4	
Permitted Phases						6						
Detector Phase	5	2		1	6	7	3	8		7	4	
Switch Phase												
Minimum Initial (s)	7.0	10.0		7.0	10.0	7.0	7.0	7.0		7.0	7.0	
Minimum Split (s)	15.0	28.2		15.0	28.2	15.0	15.0	28.0		15.0	28.1	
Total Split (s)	22.0	38.0		22.0	38.0	22.0	22.0	38.0		22.0	38.0	
Total Split (%)	18.3%	31.7%		18.3%	31.7%	18.3%	18.3%	31.7%		18.3%	31.7%	
Maximum Green (s)	16.6	31.8		16.1	31.8	16.1	16.1	32.1		16.1	32.3	
Yellow Time (s)	3.0	3.0		3.0	3.0	3.0	3.0	3.3		3.0	3.1	
All-Red Time (s)	2.4	3.2		2.9	3.2	2.9	2.9	2.6		2.9	2.6	
Lost Time Adjust (s)	-0.4	-1.2		-0.9	-1.2	-2.0	-0.9	-0.9		-0.9	-0.7	
Total Lost Time (s)	5.0	5.0		5.0	5.0	3.9	5.0	5.0		5.0	5.0	
Lead/Lag	Lead	Lag		Lead	Lag	Lead	Lead	Lag		Lead	Lag	
Lead-Lag Optimize?												
Vehicle Extension (s)	1.0	3.0		1.0	3.0	1.0	1.0	2.0		1.0	2.0	
Recall Mode	None	C-Max		None	C-Max	None	None	Ped		None	Ped	
Walk Time (s)		7.0			7.0			7.0			7.0	
Flash Dont Walk (s)		15.0			15.0			15.0			15.0	
Pedestrian Calls (#/hr)		0			0			0			0	
Act Effect Green (s)	11.8	52.5		11.2	49.4	60.7	8.6	32.2		9.2	35.4	

Lanes, Volumes, Timings

9: NC 86 (S. Columbia St)/NC 86 (N. Columbia St) & W. Franklin Street/E. Franklin Street 09/01/2020



Lane Group	EBL	EBT	EBR	WBL	WBT	WBR	NBL	NBT	NBR	SBL	SBT	SBR
Actuated g/C Ratio	0.10	0.44		0.09	0.41	0.51	0.07	0.27		0.08	0.30	
v/c Ratio	0.66	0.30		0.58	0.52	0.09	0.33	0.63		0.41	0.84	
Control Delay	78.1	23.9		79.6	22.8	9.1	82.3	20.7		91.3	26.7	
Queue Delay	0.0	0.0		0.0	0.0	0.0	0.0	0.0		0.0	0.1	
Total Delay	78.1	23.9		79.6	22.8	9.1	82.3	20.7		91.3	26.8	
LOS	E	C		E	C	A	F	C		F	C	
Approach Delay		33.9			30.8			24.9			30.8	
Approach LOS		C			C			C			C	
Queue Length 50th (ft)	70	96		62	96	11	18	163		30	147	
Queue Length 95th (ft)	113	141		110	#163	19	m44	148		70	96	
Internal Link Dist (ft)		377			861			901			273	
Turn Bay Length (ft)	250			125			475			125		
Base Capacity (vph)	194	1304		199	610	673	190	762		190	785	
Starvation Cap Reductn	0	0		0	0	0	0	0		0	6	
Spillback Cap Reductn	0	0		0	0	0	0	0		0	0	
Storage Cap Reductn	0	0		0	0	0	0	0		0	0	
Reduced v/c Ratio	0.46	0.30		0.38	0.52	0.08	0.17	0.58		0.22	0.82	

Intersection Summary

Area Type: CBD
 Cycle Length: 120
 Actuated Cycle Length: 120
 Offset: 0 (0%), Referenced to phase 2:EBT and 6:WBT, Start of Green
 Natural Cycle: 90
 Control Type: Actuated-Coordinated
 Maximum v/c Ratio: 0.84
 Intersection Signal Delay: 30.2 Intersection LOS: C
 Intersection Capacity Utilization 65.0% ICU Level of Service C
 Analysis Period (min) 15
 # 95th percentile volume exceeds capacity, queue may be longer.
 Queue shown is maximum after two cycles.
 m Volume for 95th percentile queue is metered by upstream signal.

Splits and Phases: 9: NC 86 (S. Columbia St)/NC 86 (N. Columbia St) & W. Franklin Street/E. Franklin Street

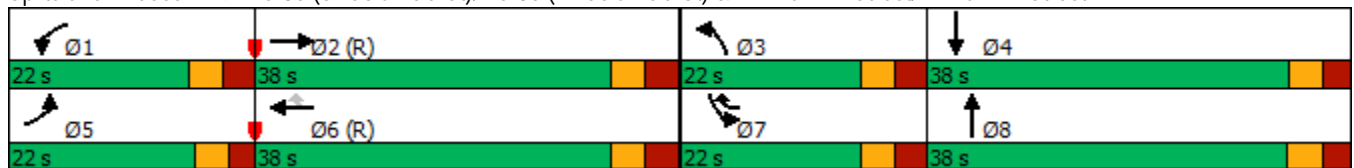

Lanes, Volumes, Timings
 10: E. Franklin Street & Henderson Street

09/01/2020



Lane Group	EBL	EBT	WBT	WBR	SBL	SBR
Lane Configurations		↕↕	↕↔		↔↕	
Traffic Volume (vph)	15	370	388	69	66	17
Future Volume (vph)	15	370	388	69	66	17
Ideal Flow (vphpl)	1900	1900	1900	1900	1900	1900
Lane Width (ft)	10	13	10	10	11	11
Grade (%)		-2%	2%		3%	
Lane Util. Factor	0.95	0.95	0.95	0.95	1.00	1.00
Ped Bike Factor		1.00	0.99		0.95	
Frt			0.977		0.972	
Flt Protected		0.998			0.962	
Satd. Flow (prot)	0	3223	2763	0	1436	0
Flt Permitted		0.933			0.962	
Satd. Flow (perm)	0	3010	2763	0	1388	0
Right Turn on Red				No		No
Satd. Flow (RTOR)						
Link Speed (mph)		20	20		20	
Link Distance (ft)		941	1200		366	
Travel Time (s)		32.1	40.9		12.5	
Confl. Peds. (#/hr)	26			26	44	87
Peak Hour Factor	0.91	0.91	0.90	0.90	0.79	0.79
Heavy Vehicles (%)	5%	5%	5%	5%	4%	4%
Parking (#/hr)						0
Adj. Flow (vph)	16	407	431	77	84	22
Shared Lane Traffic (%)						
Lane Group Flow (vph)	0	423	508	0	106	0
Turn Type	Perm	NA	NA		Prot	
Protected Phases		2	6		4	
Permitted Phases	2					
Detector Phase	2	2	6		4	
Switch Phase						
Minimum Initial (s)	10.0	10.0	10.0		7.0	
Minimum Split (s)	17.0	17.0	22.0		25.0	
Total Split (s)	32.0	32.0	32.0		28.0	
Total Split (%)	53.3%	53.3%	53.3%		46.7%	
Maximum Green (s)	25.8	25.8	25.9		22.9	
Yellow Time (s)	3.0	3.0	3.0		3.0	
All-Red Time (s)	3.2	3.2	3.1		2.1	
Lost Time Adjust (s)		-1.2	-1.1		-0.1	
Total Lost Time (s)		5.0	5.0		5.0	
Lead/Lag						
Lead-Lag Optimize?						
Vehicle Extension (s)	2.0	2.0	2.0		1.0	
Recall Mode	C-Max	C-Max	C-Max		None	
Walk Time (s)			7.0		7.0	
Flash Dont Walk (s)			8.0		12.0	
Pedestrian Calls (#/hr)			0		0	
Act Effct Green (s)		44.5	44.5		8.9	
Actuated g/C Ratio		0.74	0.74		0.15	
v/c Ratio		0.19	0.25		0.50	

Lanes, Volumes, Timings
 10: E. Franklin Street & Henderson Street

09/01/2020



Lane Group	EBL	EBT	WBT	WBR	SBL	SBR
Control Delay		6.8	4.7		28.7	
Queue Delay		0.0	0.0		0.0	
Total Delay		6.8	4.7		28.7	
LOS		A	A		C	
Approach Delay		6.8	4.7		28.7	
Approach LOS		A	A		C	
Queue Length 50th (ft)		106	118		32	
Queue Length 95th (ft)		154	18		51	
Internal Link Dist (ft)		861	1120		286	
Turn Bay Length (ft)						
Base Capacity (vph)		2234	2051		550	
Starvation Cap Reductn		0	0		0	
Spillback Cap Reductn		0	0		0	
Storage Cap Reductn		0	0		0	
Reduced v/c Ratio		0.19	0.25		0.19	

Intersection Summary

Area Type:	CBD
Cycle Length:	60
Actuated Cycle Length:	60
Offset:	53 (88%), Referenced to phase 2:EBTL and 6:WBT, Start of Green
Natural Cycle:	50
Control Type:	Actuated-Coordinated
Maximum v/c Ratio:	0.50
Intersection Signal Delay:	8.0
Intersection LOS:	A
Intersection Capacity Utilization:	47.2%
ICU Level of Service:	A
Analysis Period (min):	15

Splits and Phases: 10: E. Franklin Street & Henderson Street

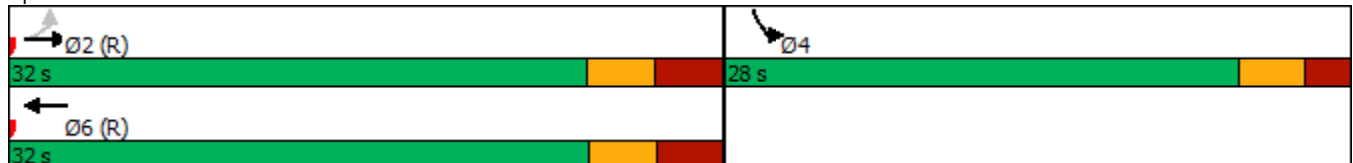

Lanes, Volumes, Timings

11: Raleigh Street/Hillsborough Street & E. Franklin Street

09/01/2020



Lane Group	EBL	EBT	EBR	WBL	WBT	WBR	NBL	NBT	NBR	SBL	SBT	SBR
Lane Configurations												
Traffic Volume (vph)	19	315	104	42	420	85	79	174	23	68	339	18
Future Volume (vph)	19	315	104	42	420	85	79	174	23	68	339	18
Ideal Flow (vphpl)	1900	1900	1900	1900	1900	1900	1900	1900	1900	1900	1900	1900
Lane Width (ft)	9	9	10	9	10	11	12	12	12	10	10	10
Grade (%)		1%			-2%			1%			1%	
Storage Length (ft)	75		0	75		0	0		0	100		0
Storage Lanes	1		0	1		0	0		0	1		0
Taper Length (ft)	25			25			25			25		
Lane Util. Factor	1.00	0.95	0.95	1.00	0.95	0.95	1.00	1.00	1.00	1.00	1.00	1.00
Ped Bike Factor	0.99	0.99		0.99	0.99			0.99		0.99	1.00	
Frt		0.963			0.975			0.989			0.992	
Flt Protected	0.950			0.950				0.986		0.950		
Satd. Flow (prot)	1539	2934	0	1578	3173	0	0	1768	0	1627	1695	0
Flt Permitted	0.398			0.435				0.637		0.502		
Satd. Flow (perm)	642	2934	0	715	3173	0	0	1138	0	852	1695	0
Right Turn on Red			No			No			No			No
Satd. Flow (RTOR)												
Link Speed (mph)		20			30			25			25	
Link Distance (ft)		1200			1013			995			363	
Travel Time (s)		40.9			23.0			27.1			9.9	
Confl. Peds. (#/hr)	9		16	16		9	25		11	11		25
Peak Hour Factor	0.86	0.86	0.86	0.92	0.92	0.92	0.83	0.83	0.83	0.96	0.96	0.96
Heavy Vehicles (%)	5%	5%	5%	4%	4%	4%	4%	4%	4%	3%	3%	3%
Adj. Flow (vph)	22	366	121	46	457	92	95	210	28	71	353	19
Shared Lane Traffic (%)												
Lane Group Flow (vph)	22	487	0	46	549	0	0	333	0	71	372	0
Turn Type	Perm	NA		Perm	NA		pm+pt	NA		D.Pm	NA	
Protected Phases		2			6		7	4				8
Permitted Phases	2			6			4			4		
Detector Phase	2	2		6	6		7	4		4		8
Switch Phase												
Minimum Initial (s)	10.0	10.0		10.0	10.0		7.0	7.0		7.0	7.0	
Minimum Split (s)	16.0	16.0		16.0	16.0		14.0	30.0		30.0	29.0	
Total Split (s)	47.0	47.0		47.0	47.0		28.0	73.0		73.0	45.0	
Total Split (%)	39.2%	39.2%		39.2%	39.2%		23.3%	60.8%		60.8%	37.5%	
Maximum Green (s)	41.7	41.7		41.7	41.7		21.8	66.6		66.6	38.6	
Yellow Time (s)	3.0	3.0		3.0	3.0		3.0	3.1		3.1	3.1	
All-Red Time (s)	2.3	2.3		2.3	2.3		3.2	3.3		3.3	3.3	
Lost Time Adjust (s)	-0.3	-0.3		-0.3	-0.3			-1.4		-1.4	-1.4	
Total Lost Time (s)	5.0	5.0		5.0	5.0			5.0		5.0	5.0	
Lead/Lag							Lead				Lag	
Lead-Lag Optimize?												
Vehicle Extension (s)	3.0	3.0		3.0	3.0		3.0	2.0		2.0	2.0	
Recall Mode	C-Max	C-Max		C-Max	C-Max		None	None		None	None	
Walk Time (s)								7.0		7.0	7.0	
Flash Dont Walk (s)								16.0		16.0	15.0	
Pedestrian Calls (#/hr)								0		0	0	
Act Effect Green (s)	59.7	59.7		59.7	59.7			50.3		50.3	50.3	

Lanes, Volumes, Timings

11: Raleigh Street/Hillsborough Street & E. Franklin Street

09/01/2020



Lane Group	EBL	EBT	EBR	WBL	WBT	WBR	NBL	NBT	NBR	SBL	SBT	SBR
Actuated g/C Ratio	0.50	0.50		0.50	0.50			0.42		0.42	0.42	
v/c Ratio	0.07	0.33		0.13	0.35			0.70		0.20	0.52	
Control Delay	14.3	13.6		22.7	21.5			35.3		16.6	23.5	
Queue Delay	0.0	0.0		0.0	0.0			0.0		0.0	2.3	
Total Delay	14.3	13.6		22.7	21.5			35.3		16.6	25.8	
LOS	B	B		C	C			D		B	C	
Approach Delay		13.6			21.6			35.3			24.3	
Approach LOS		B			C			D			C	
Queue Length 50th (ft)	6	71		19	133			206		33	198	
Queue Length 95th (ft)	15	87		54	223			216		53	232	
Internal Link Dist (ft)		1120			933			915			283	
Turn Bay Length (ft)	75			75						100		
Base Capacity (vph)	319	1460		355	1578			644		482	730	
Starvation Cap Reductn	0	0		0	0			0		0	230	
Spillback Cap Reductn	0	0		0	0			0		0	0	
Storage Cap Reductn	0	0		0	0			0		0	0	
Reduced v/c Ratio	0.07	0.33		0.13	0.35			0.52		0.15	0.74	

Intersection Summary





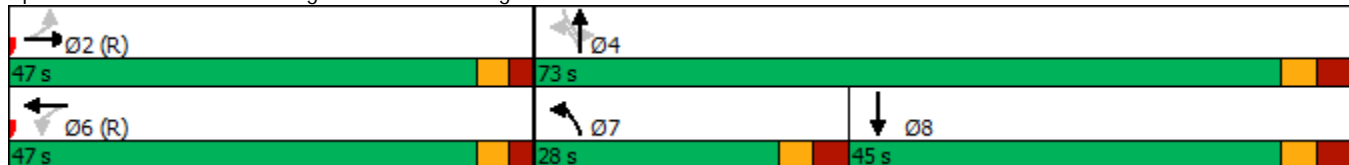













Area Type:	Other
Cycle Length:	120
Actuated Cycle Length:	120
Offset:	61 (51%), Referenced to phase 2:EBTL and 6:WBTL, Start of Green
Natural Cycle:	60
Control Type:	Actuated-Coordinated
Maximum v/c Ratio:	0.70
Intersection Signal Delay:	22.5
Intersection LOS:	C
Intersection Capacity Utilization	74.8%
ICU Level of Service	D
Analysis Period (min)	15

Splits and Phases: 11: Raleigh Street/Hillsborough Street & E. Franklin Street



Lanes, Volumes, Timings

13: NC 86 (N. Columbia St)/NC 86 (MLK Jr. Blvd) & North Street & N. Columbia Street 09/01/2020

												
Lane Group	WBL	WBR	WBR2	NBL	NBT	NBR	SBL	SBT	SBR	SEL2	SEL	SER
Lane Configurations												
Traffic Volume (vph)	2	3	20	38	438	3	77	741	2	2	6	55
Future Volume (vph)	2	3	20	38	438	3	77	741	2	2	6	55
Ideal Flow (vphpl)	1900	1900	1900	1900	1900	1900	1900	1900	1900	1900	1900	1900
Grade (%)	2%				-5%			5%				-3%
Storage Length (ft)	0	0		150		0	70		0		0	0
Storage Lanes	1	0		1		0	1		0		1	0
Taper Length (ft)	25			25			25				25	
Lane Util. Factor	1.00	1.00	1.00	1.00	0.95	0.95	1.00	0.95	0.95	1.00	1.00	1.00
Ped Bike Factor				1.00	1.00		0.99	1.00				
Frt	0.875				0.999							0.883
Flt Protected	0.996			0.950			0.950				0.993	
Satd. Flow (prot)	1490	0	0	1729	3454	0	1676	3352	0	0	1566	0
Flt Permitted	0.996			0.308			0.474				0.993	
Satd. Flow (perm)	1490	0	0	560	3454	0	830	3352	0	0	1566	0
Right Turn on Red			No			No			No			No
Satd. Flow (RTOR)												
Link Speed (mph)	20				35			35				25
Link Distance (ft)	263				476			2108				715
Travel Time (s)	9.0				9.3			41.1				19.5
Confl. Peds. (#/hr)				1		15	15		1			
Peak Hour Factor	0.48	0.48	0.48	0.93	0.93	0.93	0.89	0.89	0.89	0.76	0.76	0.76
Heavy Vehicles (%)	10%	10%	10%	7%	7%	7%	5%	5%	5%	8%	8%	8%
Adj. Flow (vph)	4	6	42	41	471	3	87	833	2	3	8	72
Shared Lane Traffic (%)												
Lane Group Flow (vph)	52	0	0	41	474	0	87	835	0	0	83	0
Turn Type	Prot			Perm	NA		Perm	NA		Prot	Prot	
Protected Phases	3				2			6		4	4	
Permitted Phases				2			6					
Detector Phase	3			2	2		6	6		4	4	
Switch Phase												
Minimum Initial (s)	7.0			10.0	10.0		10.0	10.0		7.0	7.0	
Minimum Split (s)	14.0			17.0	17.0		17.0	17.0		14.0	14.0	
Total Split (s)	23.0			70.0	70.0		70.0	70.0		27.0	27.0	
Total Split (%)	19.2%			58.3%	58.3%		58.3%	58.3%		22.5%	22.5%	
Maximum Green (s)	16.0			63.0	63.0		63.0	63.0		20.0	20.0	
Yellow Time (s)	5.0			5.0	5.0		5.0	5.0		5.0	5.0	
All-Red Time (s)	2.0			2.0	2.0		2.0	2.0		2.0	2.0	
Lost Time Adjust (s)	-2.0			-2.0	-2.0		-2.0	-2.0			-2.0	
Total Lost Time (s)	5.0			5.0	5.0		5.0	5.0			5.0	
Lead/Lag	Lead									Lag	Lag	
Lead-Lag Optimize?	Yes									Yes	Yes	
Vehicle Extension (s)	3.0			3.0	3.0		3.0	3.0		3.0	3.0	
Recall Mode	None			C-Max	C-Max		C-Max	C-Max		None	None	
Act Effct Green (s)	11.8			86.1	86.1		86.1	86.1			13.7	
Actuated g/C Ratio	0.10			0.72	0.72		0.72	0.72			0.11	
v/c Ratio	0.36			0.10	0.19		0.15	0.35			0.47	
Control Delay	56.5			4.1	3.2		9.6	9.5			57.4	
Queue Delay	0.0			0.0	0.0		0.0	0.0			0.0	

Lanes, Volumes, Timings

13: NC 86 (N. Columbia St)/NC 86 (MLK Jr. Blvd) & North Street & N. Columbia Street 09/01/2020



Lane Group	WBL	WBR	WBR2	NBL	NBT	NBR	SBL	SBT	SBR	SEL2	SEL	SER
Total Delay	56.5			4.1	3.2		9.6	9.5			57.4	
LOS	E			A	A		A	A			E	
Approach Delay	56.5				3.3			9.5			57.4	
Approach LOS	E				A			A			E	
Queue Length 50th (ft)	38			4	24		23	138			61	
Queue Length 95th (ft)	40			m9	33		56	216			90	
Internal Link Dist (ft)	183				396			2028			635	
Turn Bay Length (ft)				150			70					
Base Capacity (vph)	223			401	2477		595	2404			287	
Starvation Cap Reductn	0			0	0		0	0			0	
Spillback Cap Reductn	0			0	0		0	0			0	
Storage Cap Reductn	0			0	0		0	0			0	
Reduced v/c Ratio	0.23			0.10	0.19		0.15	0.35			0.29	

Intersection Summary

Area Type: Other
 Cycle Length: 120
 Actuated Cycle Length: 120
 Offset: 53 (44%), Referenced to phase 2:NBTL and 6:SBTL, Start of Green
 Natural Cycle: 50
 Control Type: Actuated-Coordinated
 Maximum v/c Ratio: 0.47
 Intersection Signal Delay: 11.6 Intersection LOS: B
 Intersection Capacity Utilization 57.2% ICU Level of Service B
 Analysis Period (min) 15
 m Volume for 95th percentile queue is metered by upstream signal.

Splits and Phases: 13: NC 86 (N. Columbia St)/NC 86 (MLK Jr. Blvd) & North Street & N. Columbia Street

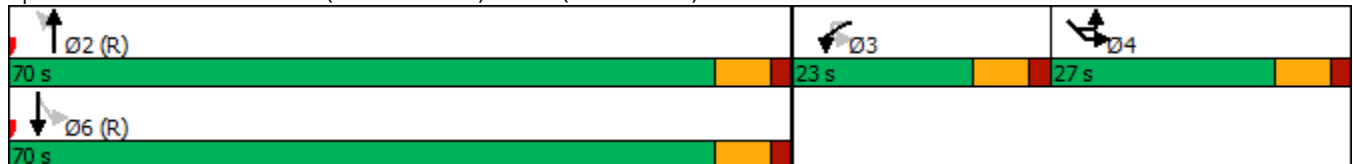

Lanes, Volumes, Timings

14: NC 86 (MLK Jr. Blvd) & Longview Street/Mill Creek Apts Driveway

09/01/2020



Lane Group	EBL	EBT	EBR	WBL	WBT	WBR	NBL	NBT	NBR	SBL	SBT	SBR
Lane Configurations		↕			↕		↕	↕↔		↕	↕↔	
Traffic Volume (vph)	78	0	10	6	0	5	2	436	5	0	731	67
Future Volume (vph)	78	0	10	6	0	5	2	436	5	0	731	67
Ideal Flow (vphpl)	1900	1900	1900	1900	1900	1900	1900	1900	1900	1900	1900	1900
Grade (%)		-6%			1%			2%			-4%	
Storage Length (ft)	0		0	0		0	225		0	250		0
Storage Lanes	0		0	0		0	1		0	1		0
Taper Length (ft)	25			25			25			25		
Lane Util. Factor	1.00	1.00	1.00	1.00	1.00	1.00	1.00	0.95	0.95	1.00	0.95	0.95
Ped Bike Factor		1.00			0.99		1.00	1.00			1.00	
Frt		0.985			0.944			0.998			0.987	
Flt Protected		0.958			0.972		0.950					
Satd. Flow (prot)	0	1737	0	0	1701	0	1686	3364	0	1846	3453	0
Flt Permitted		0.741			0.817		0.256					
Satd. Flow (perm)	0	1343	0	0	1420	0	453	3364	0	1846	3453	0
Right Turn on Red			No			No			No			No
Satd. Flow (RTOR)												
Link Speed (mph)		25			20			35			35	
Link Distance (ft)		451			338			2108			784	
Travel Time (s)		12.3			11.5			41.1			15.3	
Confl. Peds. (#/hr)			16	16			4		4	4		4
Peak Hour Factor	0.52	0.52	0.52	0.92	0.92	0.92	0.93	0.93	0.93	0.84	0.84	0.84
Heavy Vehicles (%)	6%	6%	6%	2%	2%	2%	6%	6%	6%	5%	5%	5%
Adj. Flow (vph)	150	0	19	7	0	5	2	469	5	0	870	80
Shared Lane Traffic (%)												
Lane Group Flow (vph)	0	169	0	0	12	0	2	474	0	0	950	0
Turn Type	Perm	NA		Perm	NA		Perm	NA		Perm	NA	
Protected Phases		4			8			2			6	
Permitted Phases	4			8			2			6		
Detector Phase	4	4		8	8		2	2		6	6	
Switch Phase												
Minimum Initial (s)	7.0	7.0		7.0	7.0		12.0	12.0		12.0	12.0	
Minimum Split (s)	31.0	31.0		14.0	14.0		28.0	28.0		28.0	28.0	
Total Split (s)	20.0	20.0		20.0	20.0		60.0	60.0		60.0	60.0	
Total Split (%)	25.0%	25.0%		25.0%	25.0%		75.0%	75.0%		75.0%	75.0%	
Maximum Green (s)	14.0	14.0		13.9	13.9		54.0	54.0		54.5	54.5	
Yellow Time (s)	3.5	3.5		3.0	3.0		4.5	4.5		4.0	4.0	
All-Red Time (s)	2.5	2.5		3.1	3.1		1.5	1.5		1.5	1.5	
Lost Time Adjust (s)		-1.0			-1.0		-1.0	-1.0		-0.5	-0.5	
Total Lost Time (s)		5.0			5.1		5.0	5.0		5.0	5.0	
Lead/Lag												
Lead-Lag Optimize?												
Vehicle Extension (s)	3.0	3.0		3.0	3.0		3.0	3.0		3.0	3.0	
Recall Mode	None	None		None	None		Min	Min		Min	Min	
Walk Time (s)	7.0	7.0					7.0	7.0		7.0	7.0	
Flash Dont Walk (s)	17.0	17.0					9.0	9.0		9.0	9.0	
Pedestrian Calls (#/hr)	0	0					0	0		0	0	
Act Effct Green (s)		11.9			11.8		22.6	22.6			22.6	
Actuated g/C Ratio		0.27			0.26		0.51	0.51			0.51	

Lanes, Volumes, Timings

14: NC 86 (MLK Jr. Blvd) & Longview Street/Mill Creek Apts Driveway

09/01/2020



Lane Group	EBL	EBT	EBR	WBL	WBT	WBR	NBL	NBT	NBR	SBL	SBT	SBR
v/c Ratio		0.47			0.03		0.01	0.28				0.54
Control Delay		18.7			12.8		6.0	7.2				9.2
Queue Delay		0.0			0.0		0.0	0.0				0.0
Total Delay		18.7			12.8		6.0	7.2				9.2
LOS		B			B		A	A				A
Approach Delay		18.7			12.8			7.2				9.2
Approach LOS		B			B			A				A
Queue Length 50th (ft)		32			2		0	31				75
Queue Length 95th (ft)		45			12		3	60				120
Internal Link Dist (ft)		371			258			2028				704
Turn Bay Length (ft)							225					
Base Capacity (vph)		458			481		453	3364				3453
Starvation Cap Reductn		0			0		0	0				0
Spillback Cap Reductn		0			0		0	0				0
Storage Cap Reductn		0			0		0	0				0
Reduced v/c Ratio		0.37			0.02		0.00	0.14				0.28

Intersection Summary

Area Type:	Other
Cycle Length:	80
Actuated Cycle Length:	44.6
Natural Cycle:	60
Control Type:	Actuated-Uncoordinated
Maximum v/c Ratio:	0.54
Intersection Signal Delay:	9.6
Intersection LOS:	A
Intersection Capacity Utilization:	43.5%
ICU Level of Service:	A
Analysis Period (min):	15

Splits and Phases: 14: NC 86 (MLK Jr. Blvd) & Longview Street/Mill Creek Apts Driveway



Lanes, Volumes, Timings
 15: NC 86 (Pittsboro St) & W. Cameron Avenue

09/01/2020



Lane Group	EBT	EBR	WBL	WBT	NBL	NBR	Ø1	Ø4
Lane Configurations	↻		↻↻	↻				
Traffic Volume (vph)	118	161	607	135	0	0		
Future Volume (vph)	118	161	607	135	0	0		
Ideal Flow (vphpl)	1900	1900	1900	1900	1900	1900		
Lane Width (ft)	12	12	11	12	12	12		
Grade (%)	3%			-3%	0%			
Storage Length (ft)		0	75		0	0		
Storage Lanes		0	0		0	0		
Taper Length (ft)			25		25			
Lane Util. Factor	1.00	1.00	0.97	1.00	1.00	1.00		
Ped Bike Factor	0.94		0.90					
Frt	0.922							
Flt Protected			0.950					
Satd. Flow (prot)	1432	0	2837	1592	0	0		
Flt Permitted			0.950					
Satd. Flow (perm)	1432	0	2564	1592	0	0		
Right Turn on Red		No				No		
Satd. Flow (RTOR)								
Link Speed (mph)	25			25	25			
Link Distance (ft)	391			120	794			
Travel Time (s)	30.0			10.7	21.7			
Confl. Peds. (#/hr)		57	57					
Peak Hour Factor	0.81	0.81	0.87	0.87	0.90	0.90		
Heavy Vehicles (%)	2%	2%	9%	9%	2%	2%		
Adj. Flow (vph)	146	199	698	155	0	0		
Shared Lane Traffic (%)								
Lane Group Flow (vph)	345	0	698	155	0	0		
Turn Type	NA		Prot	NA				
Protected Phases	2		1 4	6			1	4
Permitted Phases								
Detector Phase	2		1 4	6				
Switch Phase								
Minimum Initial (s)	10.0			10.0			7.0	7.0
Minimum Split (s)	17.0			15.0			13.0	20.0
Total Split (s)	25.0			40.0			15.0	20.0
Total Split (%)	41.7%			66.7%			25%	33%
Maximum Green (s)	19.9			35.0			9.9	16.0
Yellow Time (s)	3.0			3.3			3.0	3.0
All-Red Time (s)	2.1			1.7			2.1	1.0
Lost Time Adjust (s)	-0.1			0.0				
Total Lost Time (s)	5.0			5.0				
Lead/Lag	Lag						Lead	
Lead-Lag Optimize?								
Vehicle Extension (s)	1.0			1.0			4.0	0.2
Recall Mode	None			C-Max			C-Max	None
Walk Time (s)	7.0							7.0
Flash Dont Walk (s)	4.0							9.0
Pedestrian Calls (#/hr)	0							0
Act Effect Green (s)	20.0		30.0	38.7				

Lanes, Volumes, Timings
 15: NC 86 (Pittsboro St) & W. Cameron Avenue

09/01/2020



Lane Group	EBT	EBR	WBL	WBT	NBL	NBR	Ø1	Ø4
Actuated g/C Ratio	0.33		0.50	0.64				
v/c Ratio	0.72		0.49	0.15				
Control Delay	28.6		14.4	6.0				
Queue Delay	0.0		0.0	0.0				
Total Delay	28.6		14.4	6.0				
LOS	C		B	A				
Approach Delay	28.6			12.9				
Approach LOS	C			B				
Queue Length 50th (ft)	107		193	31				
Queue Length 95th (ft)	166		185	m84				
Internal Link Dist (ft)	311			40	714			
Turn Bay Length (ft)			75					
Base Capacity (vph)	477		1372	1026				
Starvation Cap Reductn	0		0	0				
Spillback Cap Reductn	0		0	0				
Storage Cap Reductn	0		0	0				
Reduced v/c Ratio	0.72		0.51	0.15				

Intersection Summary

Area Type: CBD
 Cycle Length: 60
 Actuated Cycle Length: 60
 Offset: 23 (38%), Referenced to phase 1:WBL and 6:WBT, Start of Green
 Natural Cycle: 60
 Control Type: Actuated-Coordinated
 Maximum v/c Ratio: 0.72
 Intersection Signal Delay: 17.4 Intersection LOS: B
 Intersection Capacity Utilization 47.9% ICU Level of Service A
 Analysis Period (min) 15
 m Volume for 95th percentile queue is metered by upstream signal.

Splits and Phases: 15: NC 86 (Pittsboro St) & W. Cameron Avenue

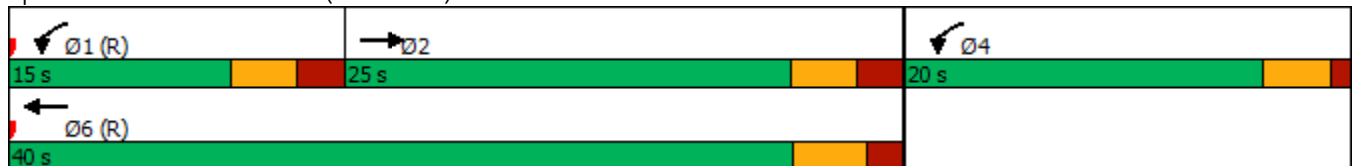

Lanes, Volumes, Timings

16: NC 86 (S. Columbia St) & W. Cameron Avenue/E. Cameron Avenue

09/01/2020



Lane Group	EBL	EBT	EBR	WBL	WBT	WBR	NBL	NBT	NBR	SBL	SBT	SBR
Lane Configurations												
Traffic Volume (vph)	16	92	0	0	96	20	99	395	43	67	0	543
Future Volume (vph)	16	92	0	0	96	20	99	395	43	67	0	543
Ideal Flow (vphpl)	1900	1900	1900	1900	1900	1900	1900	1900	1900	1900	1900	1900
Lane Width (ft)	11	12	12	12	12	12	10	10	10	11	11	12
Grade (%)		1%			-1%			1%			2%	
Storage Length (ft)	100		0	0		0	0		0	310		0
Storage Lanes	1		0	0		0	1		0	1		2
Taper Length (ft)	25			25			25			25		
Lane Util. Factor	1.00	1.00	1.00	1.00	1.00	1.00	0.91	0.91	0.95	1.00	1.00	0.88
Ped Bike Factor	0.95				0.99		0.79	0.95		0.75		0.77
Frt					0.977			0.986				0.850
Flt Protected	0.950						0.950	0.999		0.950		
Satd. Flow (prot)	1532	1668	0	0	1565	0	1248	2460	0	1413	0	2302
Flt Permitted	0.517						0.950	0.999		0.950		
Satd. Flow (perm)	796	1668	0	0	1565	0	982	2448	0	1066	0	1776
Right Turn on Red			No			No			No			No
Satd. Flow (RTOR)												
Link Speed (mph)		25			25			25				25
Link Distance (ft)		273			989			826				981
Travel Time (s)		10.7			57.6			22.5				26.8
Confl. Peds. (#/hr)	39		102	102		39	71		107	107		71
Peak Hour Factor	0.79	0.79	0.79	0.83	0.83	0.83	0.86	0.86	0.86	0.89	0.89	0.89
Heavy Vehicles (%)	2%	2%	2%	6%	6%	6%	10%	10%	10%	10%	10%	10%
Adj. Flow (vph)	20	116	0	0	116	24	115	459	50	75	0	610
Shared Lane Traffic (%)							10%					
Lane Group Flow (vph)	20	116	0	0	140	0	103	521	0	75	0	610
Turn Type	Perm	NA			NA		Split	NA		Prot		Prot
Protected Phases		4			8		2	2		1		1
Permitted Phases	4									1		1
Detector Phase	4	4			8		2	2		1		1
Switch Phase												
Minimum Initial (s)	10.0	10.0			10.0		7.0	7.0		7.0		7.0
Minimum Split (s)	24.0	24.0			31.0		18.0	18.0		26.0		26.0
Total Split (s)	34.0	34.0			34.0		22.0	22.0		36.0		36.0
Total Split (%)	28.3%	28.3%			28.3%		18.3%	18.3%		30.0%		30.0%
Maximum Green (s)	27.8	27.8			27.8		16.1	16.1		30.4		30.4
Yellow Time (s)	3.2	3.2			3.2		3.1	3.1		3.0		3.0
All-Red Time (s)	3.0	3.0			3.0		2.8	2.8		2.6		2.6
Lost Time Adjust (s)	-1.2	-1.2			-1.2		-0.9	-0.9		-0.6		-0.6
Total Lost Time (s)	5.0	5.0			5.0		5.0	5.0		5.0		5.0
Lead/Lag							Lag	Lag		Lead		Lead
Lead-Lag Optimize?							Yes	Yes		Yes		Yes
Vehicle Extension (s)	2.0	2.0			2.0		4.0	4.0		4.0		4.0
Recall Mode	None	None			None		C-Max	C-Max		None		None
Walk Time (s)	7.0	7.0			7.0		7.0	7.0		7.0		7.0
Flash Dont Walk (s)	10.0	10.0			17.0		5.0	5.0		13.0		13.0
Pedestrian Calls (#/hr)	0	0			0		0	0		0		0
Act Effect Green (s)	16.5	16.5			16.5		46.0	46.0		42.5		42.5

Lanes, Volumes, Timings

16: NC 86 (S. Columbia St) & W. Cameron Avenue/E. Cameron Avenue

09/01/2020

Lane Group	Ø9
Lane Configurations	
Traffic Volume (vph)	
Future Volume (vph)	
Ideal Flow (vphpl)	
Lane Width (ft)	
Grade (%)	
Storage Length (ft)	
Storage Lanes	
Taper Length (ft)	
Lane Util. Factor	
Ped Bike Factor	
Frt	
Flt Protected	
Satd. Flow (prot)	
Flt Permitted	
Satd. Flow (perm)	
Right Turn on Red	
Satd. Flow (RTOR)	
Link Speed (mph)	
Link Distance (ft)	
Travel Time (s)	
Confl. Peds. (#/hr)	
Peak Hour Factor	
Heavy Vehicles (%)	
Adj. Flow (vph)	
Shared Lane Traffic (%)	
Lane Group Flow (vph)	
Turn Type	
Protected Phases	9
Permitted Phases	
Detector Phase	
Switch Phase	
Minimum Initial (s)	7.0
Minimum Split (s)	28.0
Total Split (s)	28.0
Total Split (%)	23%
Maximum Green (s)	24.0
Yellow Time (s)	3.0
All-Red Time (s)	1.0
Lost Time Adjust (s)	
Total Lost Time (s)	
Lead/Lag	
Lead-Lag Optimize?	
Vehicle Extension (s)	0.2
Recall Mode	None
Walk Time (s)	7.0
Flash Dont Walk (s)	17.0
Pedestrian Calls (#/hr)	0
Act Effect Green (s)	

Lanes, Volumes, Timings

16: NC 86 (S. Columbia St) & W. Cameron Avenue/E. Cameron Avenue

09/01/2020



Lane Group	EBL	EBT	EBR	WBL	WBT	WBR	NBL	NBT	NBR	SBL	SBT	SBR
Actuated g/C Ratio	0.14	0.14			0.14		0.38	0.38		0.35		0.35
v/c Ratio	0.18	0.51			0.65		0.22	0.55		0.15		0.75
Control Delay	35.9	41.1			62.5		28.4	33.0		7.1		16.7
Queue Delay	0.0	0.0			0.0		0.0	0.0		0.0		0.0
Total Delay	35.9	41.1			62.5		28.4	33.0		7.1		16.7
LOS	D	D			E		C	C		A		B
Approach Delay		40.3			62.5			32.2			15.6	
Approach LOS		D			E			C			B	
Queue Length 50th (ft)	11	82			104		58	170		5		87
Queue Length 95th (ft)	m15	m108			150		112	242		m16		302
Internal Link Dist (ft)		193			909			746			901	
Turn Bay Length (ft)	100									310		
Base Capacity (vph)	192	403			378		478	942		500		814
Starvation Cap Reductn	0	0			0		0	0		0		0
Spillback Cap Reductn	0	0			0		0	0		0		0
Storage Cap Reductn	0	0			0		0	0		0		0
Reduced v/c Ratio	0.10	0.29			0.37		0.22	0.55		0.15		0.75

Intersection Summary

Area Type:	CBD
Cycle Length:	120
Actuated Cycle Length:	120
Offset:	39 (33%), Referenced to phase 2:NBTL, Start of Green
Natural Cycle:	125
Control Type:	Actuated-Coordinated
Maximum v/c Ratio:	0.75
Intersection Signal Delay:	28.4
Intersection LOS:	C
Intersection Capacity Utilization:	68.2%
ICU Level of Service:	C
Analysis Period (min):	15
m Volume for 95th percentile queue is metered by upstream signal.	

Splits and Phases: 16: NC 86 (S. Columbia St) & W. Cameron Avenue/E. Cameron Avenue

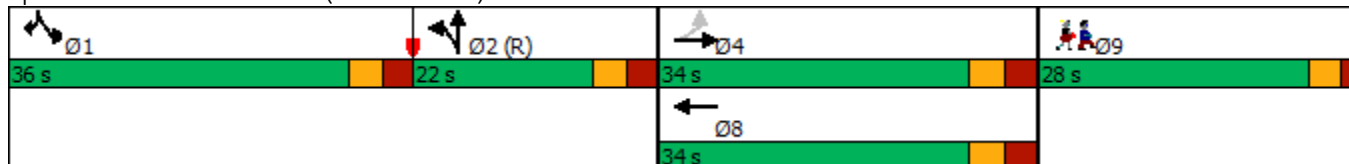

Lanes, Volumes, Timings

16: NC 86 (S. Columbia St) & W. Cameron Avenue/E. Cameron Avenue

09/01/2020

Lane Group	Ø9
Actuated g/C Ratio	
v/c Ratio	
Control Delay	
Queue Delay	
Total Delay	
LOS	
Approach Delay	
Approach LOS	
Queue Length 50th (ft)	
Queue Length 95th (ft)	
Internal Link Dist (ft)	
Turn Bay Length (ft)	
Base Capacity (vph)	
Starvation Cap Reductn	
Spillback Cap Reductn	
Storage Cap Reductn	
Reduced v/c Ratio	
Intersection Summary	

Lanes, Volumes, Timings

17: Raleigh Street & E. Cameron Avenue/Country Club Road

09/01/2020



Lane Group	EBL	EBT	EBR	WBL	WBT	WBR	NBL	NBT	NBR	SBL	SBT	SBR
Lane Configurations		↕		↕	↕		↕	↕		↕	↕	
Traffic Volume (vph)	23	44	32	28	143	212	24	45	17	301	149	48
Future Volume (vph)	23	44	32	28	143	212	24	45	17	301	149	48
Ideal Flow (vphpl)	1900	1900	1900	1900	1900	1900	1900	1900	1900	1900	1900	1900
Grade (%)		-3%			3%			-2%				1%
Storage Length (ft)	0		0	150		0	125		0	75		0
Storage Lanes	0		0	1		0	1		0	1		0
Taper Length (ft)	25			25			25			25		
Lane Util. Factor	1.00	1.00	1.00	1.00	1.00	1.00	1.00	1.00	1.00	1.00	1.00	1.00
Ped Bike Factor		0.98		0.98	0.98		0.91	0.96		0.89	0.95	
Frt		0.956			0.910			0.958			0.964	
Flt Protected		0.989		0.950			0.950			0.950		
Satd. Flow (prot)	0	1493	0	1569	1472	0	1492	1446	0	1569	1511	0
Flt Permitted		0.834		0.569			0.626			0.455		
Satd. Flow (perm)	0	1257	0	925	1472	0	894	1446	0	671	1511	0
Right Turn on Red			No			No			No			No
Satd. Flow (RTOR)												
Link Speed (mph)		25			25			25				25
Link Distance (ft)		598			651			409				995
Travel Time (s)		16.3			17.8			11.2				27.1
Confl. Peds. (#/hr)	3		6	6		3	31		25	25		31
Peak Hour Factor	0.71	0.71	0.71	0.84	0.84	0.84	0.79	0.79	0.79	0.94	0.94	0.94
Heavy Vehicles (%)	8%	8%	8%	2%	2%	2%	10%	10%	10%	3%	3%	3%
Adj. Flow (vph)	32	62	45	33	170	252	30	57	22	320	159	51
Shared Lane Traffic (%)												
Lane Group Flow (vph)	0	139	0	33	422	0	30	79	0	320	210	0
Turn Type	Perm	NA		pm+pt	NA		pm+pt	NA		pm+pt	NA	
Protected Phases		2		1	6		3	8		7	4	
Permitted Phases	2			6			8			4		
Detector Phase	2	2		1	6		3	8		7	4	
Switch Phase												
Minimum Initial (s)	10.0	10.0		7.0	10.0		7.0	7.0		7.0	7.0	
Minimum Split (s)	18.0	18.0		13.0	19.0		13.0	19.0		12.0	16.0	
Total Split (s)	50.0	50.0		20.0	70.0		20.0	35.0		20.0	35.0	
Total Split (%)	40.0%	40.0%		16.0%	56.0%		16.0%	28.0%		16.0%	28.0%	
Maximum Green (s)	43.9	43.9		14.4	64.4		14.7	29.7		15.1	29.9	
Yellow Time (s)	3.3	3.3		3.0	3.1		3.0	3.1		3.0	3.1	
All-Red Time (s)	2.8	2.8		2.6	2.5		2.3	2.2		1.9	2.0	
Lost Time Adjust (s)		-1.1		-0.6	-0.6		-0.3	-0.3		0.1	-0.1	
Total Lost Time (s)		5.0		5.0	5.0		5.0	5.0		5.0	5.0	
Lead/Lag	Lag	Lag		Lead			Lead	Lag		Lead	Lag	
Lead-Lag Optimize?	Yes	Yes		Yes			Yes	Yes		Yes	Yes	
Vehicle Extension (s)	2.0	2.0		2.0	2.0		2.0	2.0		2.0	2.0	
Recall Mode	None	None		None	None		None	None		None	None	
Walk Time (s)	4.0	4.0			4.0			4.0			4.0	
Flash Dont Walk (s)	7.0	7.0			9.0			9.0			6.0	
Pedestrian Calls (#/hr)	0	0			0			0			0	
Act Effect Green (s)		19.6		23.6	23.6		15.3	10.0		25.3	21.4	
Actuated g/C Ratio		0.33		0.39	0.39		0.25	0.17		0.42	0.36	

Lanes, Volumes, Timings

17: Raleigh Street & E. Cameron Avenue/Country Club Road

09/01/2020



Lane Group	EBL	EBT	EBR	WBL	WBT	WBR	NBL	NBT	NBR	SBL	SBT	SBR
v/c Ratio		0.34		0.07	0.73		0.10	0.33		0.64	0.39	
Control Delay		22.4		12.6	25.0		14.5	31.7		21.7	21.8	
Queue Delay		0.0		0.0	0.0		0.0	0.0		0.0	0.0	
Total Delay		22.4		12.6	25.0		14.5	31.7		21.7	21.8	
LOS		C		B	C		B	C		C	C	
Approach Delay		22.4			24.1			27.0			21.7	
Approach LOS		C			C			C			C	
Queue Length 50th (ft)		35		8	133		6	28		77	47	
Queue Length 95th (ft)		79		22	230		23	68		#219	165	
Internal Link Dist (ft)		518			571			329			915	
Turn Bay Length (ft)				150			125			75		
Base Capacity (vph)		936		568	1385		525	813		561	850	
Starvation Cap Reductn		0		0	0		0	0		0	0	
Spillback Cap Reductn		0		0	0		0	0		0	0	
Storage Cap Reductn		0		0	0		0	0		0	0	
Reduced v/c Ratio		0.15		0.06	0.30		0.06	0.10		0.57	0.25	

Intersection Summary

Area Type: CBD
 Cycle Length: 125
 Actuated Cycle Length: 60.2
 Natural Cycle: 65
 Control Type: Actuated-Uncoordinated
 Maximum v/c Ratio: 0.73
 Intersection Signal Delay: 23.1
 Intersection LOS: C
 Intersection Capacity Utilization 61.8%
 ICU Level of Service B
 Analysis Period (min) 15
 # 95th percentile volume exceeds capacity, queue may be longer.
 Queue shown is maximum after two cycles.

Splits and Phases: 17: Raleigh Street & E. Cameron Avenue/Country Club Road



Lanes, Volumes, Timings
1: Church Street & W. Rosemary Street

09/01/2020



Lane Group	EBL	EBT	EBR	WBL	WBT	WBR	NBL	NBT	NBR	SBL	SBT	SBR
Lane Configurations		↕			↕			↕			↕	
Traffic Volume (vph)	6	326	29	44	356	24	23	42	58	14	33	10
Future Volume (vph)	6	326	29	44	356	24	23	42	58	14	33	10
Ideal Flow (vphpl)	1900	1900	1900	1900	1900	1900	1900	1900	1900	1900	1900	1900
Lane Width (ft)	12	14	12	12	14	12	12	12	12	12	12	12
Grade (%)		1%			-1%			0%			0%	
Lane Util. Factor	1.00	1.00	1.00	1.00	1.00	1.00	1.00	1.00	1.00	1.00	1.00	1.00
Ped Bike Factor		0.99			0.99			0.92			0.95	
Frt		0.989			0.992			0.937			0.976	
Flt Protected		0.999			0.995			0.991			0.988	
Satd. Flow (prot)	0	1710	0	0	1748	0	0	1477	0	0	1562	0
Flt Permitted		0.994			0.934			0.922			0.918	
Satd. Flow (perm)	0	1700	0	0	1634	0	0	1335	0	0	1426	0
Right Turn on Red			No			No			No			No
Satd. Flow (RTOR)												
Link Speed (mph)		20			20			25			25	
Link Distance (ft)		964			757			379			430	
Travel Time (s)		32.9			25.8			10.3			11.7	
Confl. Peds. (#/hr)	22		24	24		22	75		39	39		75
Peak Hour Factor	0.88	0.88	0.88	0.93	0.93	0.93	0.92	0.92	0.92	0.64	0.64	0.64
Heavy Vehicles (%)	4%	4%	4%	3%	3%	3%	2%	2%	2%	2%	2%	2%
Adj. Flow (vph)	7	370	33	47	383	26	25	46	63	22	52	16
Shared Lane Traffic (%)												
Lane Group Flow (vph)	0	410	0	0	456	0	0	134	0	0	90	0
Turn Type	Perm	NA		Perm	NA		Perm	NA		Perm	NA	
Protected Phases		2			6			8			4	
Permitted Phases	2			6			8			4		
Detector Phase	2	2		6	6		8	8		4	4	
Switch Phase												
Minimum Initial (s)	10.0	10.0		10.0	10.0		7.0	7.0		7.0	7.0	
Minimum Split (s)	19.0	19.0		20.0	20.0		19.0	19.0		19.0	19.0	
Total Split (s)	43.0	43.0		43.0	43.0		22.0	22.0		22.0	22.0	
Total Split (%)	66.2%	66.2%		66.2%	66.2%		33.8%	33.8%		33.8%	33.8%	
Maximum Green (s)	38.5	38.5		38.4	38.4		17.1	17.1		17.1	17.1	
Yellow Time (s)	3.1	3.1		3.1	3.1		3.2	3.2		3.2	3.2	
All-Red Time (s)	1.4	1.4		1.5	1.5		1.7	1.7		1.7	1.7	
Lost Time Adjust (s)		0.5			0.4			0.1			0.1	
Total Lost Time (s)		5.0			5.0			5.0			5.0	
Lead/Lag												
Lead-Lag Optimize?												
Vehicle Extension (s)	3.0	3.0		3.0	3.0		3.0	3.0		3.0	3.0	
Recall Mode	C-Max	C-Max		C-Max	C-Max		None	None		None	None	
Walk Time (s)	4.0	4.0		4.0	4.0		4.0	4.0		4.0	4.0	
Flash Dont Walk (s)	5.0	5.0		6.0	6.0		10.0	10.0		10.0	10.0	
Pedestrian Calls (#/hr)	0	0		0	0		0	0		0	0	
Act Effct Green (s)		46.8			46.8			11.6			11.6	
Actuated g/C Ratio		0.72			0.72			0.18			0.18	
v/c Ratio		0.34			0.39			0.57			0.35	
Control Delay		6.1			2.5			32.2			26.0	

Lanes, Volumes, Timings
 1: Church Street & W. Rosemary Street

09/01/2020



Lane Group	EBL	EBT	EBR	WBL	WBT	WBR	NBL	NBT	NBR	SBL	SBT	SBR
Queue Delay		0.0			0.0			0.0			0.0	
Total Delay		6.1			2.5			32.2			26.0	
LOS		A			A			C			C	
Approach Delay		6.1			2.5			32.2			26.0	
Approach LOS		A			A			C			C	
Queue Length 50th (ft)		58			20			50			32	
Queue Length 95th (ft)		125			45			65			43	
Internal Link Dist (ft)		884			677			299			350	
Turn Bay Length (ft)												
Base Capacity (vph)		1223			1176			349			372	
Starvation Cap Reductn		0			0			0			0	
Spillback Cap Reductn		0			0			0			0	
Storage Cap Reductn		0			0			0			0	
Reduced v/c Ratio		0.34			0.39			0.38			0.24	

Intersection Summary

Area Type:	CBD
Cycle Length:	65
Actuated Cycle Length:	65
Offset:	23 (35%), Referenced to phase 2:EBTL and 6:WBTL, Start of Green
Natural Cycle:	40
Control Type:	Actuated-Coordinated
Maximum v/c Ratio:	0.57
Intersection Signal Delay:	9.4
Intersection LOS:	A
Intersection Capacity Utilization	70.8%
ICU Level of Service	C
Analysis Period (min)	15

Splits and Phases: 1: Church Street & W. Rosemary Street

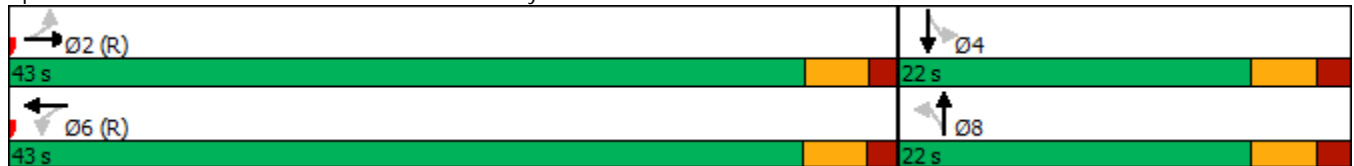

Lanes, Volumes, Timings

2: NC 86 (N. Columbia St) & W. Rosemary Street/E. Rosemary Street

09/01/2020



Lane Group	EBL	EBT	EBR	WBL	WBT	WBR	NBL	NBT	NBR	SBL	SBT	SBR
Lane Configurations												
Traffic Volume (vph)	157	204	48	61	217	38	44	318	128	48	360	180
Future Volume (vph)	157	204	48	61	217	38	44	318	128	48	360	180
Ideal Flow (vphpl)	1900	1900	1900	1900	1900	1900	1900	1900	1900	1900	1900	1900
Lane Width (ft)	9	12	13	12	12	12	9	10	12	12	9	11
Grade (%)		1%			1%			-2%			8%	
Storage Length (ft)	100		0	150		0	75		0	150		400
Storage Lanes	1		0	1		0	1		0	1		1
Taper Length (ft)	25			25			25			25		
Lane Util. Factor	1.00	1.00	1.00	1.00	1.00	1.00	1.00	0.95	0.95	1.00	0.95	1.00
Ped Bike Factor	0.97	0.99		0.96	0.99		0.86	0.86		0.80		0.66
Frt		0.971			0.977			0.957				0.850
Flt Protected	0.950			0.950			0.950			0.950		
Satd. Flow (prot)	1426	1597	0	1585	1608	0	1355	2299	0	1485	2673	1285
Flt Permitted	0.284			0.584			0.439			0.425		
Satd. Flow (perm)	413	1597	0	932	1608	0	536	2299	0	530	2673	850
Right Turn on Red			No			No			No			No
Satd. Flow (RTOR)												
Link Speed (mph)		20			20			25			25	
Link Distance (ft)		757			456			353			476	
Travel Time (s)		25.8			15.5			9.6			13.0	
Confl. Peds. (#/hr)	53		41	41		53	80		129	129		80
Peak Hour Factor	0.88	0.88	0.88	0.85	0.85	0.85	0.98	0.98	0.98	0.86	0.86	0.86
Heavy Vehicles (%)	2%	2%	2%	2%	2%	2%	9%	9%	9%	5%	5%	5%
Adj. Flow (vph)	178	232	55	72	255	45	45	324	131	56	419	209
Shared Lane Traffic (%)												
Lane Group Flow (vph)	178	287	0	72	300	0	45	455	0	56	419	209
Turn Type	pm+pt	NA		Perm	NA		pm+pt	NA		pm+pt	NA	pm+ov
Protected Phases	7	4			8		5	2		1	6	7
Permitted Phases	4			8			2			6		6
Detector Phase	7	4		8	8		5	2		1	6	7
Switch Phase												
Minimum Initial (s)	7.0	7.0		7.0	7.0		7.0	10.0		7.0	10.0	7.0
Minimum Split (s)	13.0	31.0		32.0	32.0		13.0	23.0		13.0	22.0	13.0
Total Split (s)	43.0	63.0		20.0	20.0		15.0	52.0		15.0	52.0	43.0
Total Split (%)	33.1%	48.5%		15.4%	15.4%		11.5%	40.0%		11.5%	40.0%	33.1%
Maximum Green (s)	37.2	57.0		14.0	14.0		9.2	46.2		9.9	46.2	37.2
Yellow Time (s)	3.0	3.2		3.2	3.2		3.0	3.3		3.0	3.3	3.0
All-Red Time (s)	2.8	2.8		2.8	2.8		2.8	2.5		2.1	2.5	2.8
Lost Time Adjust (s)	-0.8	-1.0		-1.0	-1.0		0.0	-0.8		-0.1	-0.8	-0.8
Total Lost Time (s)	5.0	5.0		5.0	5.0		5.8	5.0		5.0	5.0	5.0
Lead/Lag	Lead			Lag	Lag		Lead	Lag		Lead	Lag	Lead
Lead-Lag Optimize?												
Vehicle Extension (s)	1.0	1.0		1.0	1.0		1.0	3.0		1.0	3.0	1.0
Recall Mode	None	None		None	None		None	C-Max		None	C-Max	None
Walk Time (s)		7.0		7.0	7.0			7.0			7.0	
Flash Dont Walk (s)		18.0		19.0	19.0			10.0			9.0	
Pedestrian Calls (#/hr)		0		0	0			0			0	
Act Effect Green (s)	58.0	58.0		33.3	33.3		57.0	51.9		57.6	51.5	71.2

Lanes, Volumes, Timings

2: NC 86 (N. Columbia St) & W. Rosemary Street/E. Rosemary Street

09/01/2020



Lane Group	EBL	EBT	EBR	WBL	WBT	WBR	NBL	NBT	NBR	SBL	SBT	SBR
Actuated g/C Ratio	0.45	0.45		0.26	0.26		0.44	0.40		0.44	0.40	0.55
v/c Ratio	0.53	0.40		0.30	0.73		0.16	0.50		0.19	0.40	0.39
Control Delay	29.5	27.4		42.9	53.7		16.5	19.4		13.9	19.6	9.0
Queue Delay	0.0	0.0		0.0	0.0		0.0	0.5		0.0	0.0	0.0
Total Delay	29.5	27.4		42.9	53.7		16.5	19.9		13.9	19.6	9.0
LOS	C	C		D	D		B	B		B	B	A
Approach Delay		28.2			51.6			19.6			15.9	
Approach LOS		C			D			B			B	
Queue Length 50th (ft)	93	185		44	217		11	57		14	93	35
Queue Length 95th (ft)	125	236		94	#384		m26	113		22	85	33
Internal Link Dist (ft)		677			376			273			396	
Turn Bay Length (ft)	100			150			75			150		400
Base Capacity (vph)	480	712		238	411		299	918		315	1058	712
Starvation Cap Reductn	0	0		0	0		0	161		0	0	0
Spillback Cap Reductn	0	0		0	0		0	0		0	0	0
Storage Cap Reductn	0	0		0	0		0	0		0	0	0
Reduced v/c Ratio	0.37	0.40		0.30	0.73		0.15	0.60		0.18	0.40	0.29

Intersection Summary

Area Type: CBD
 Cycle Length: 130
 Actuated Cycle Length: 130
 Offset: 55 (42%), Referenced to phase 2:NBTL and 6:SBTL, Start of Green
 Natural Cycle: 85
 Control Type: Actuated-Coordinated
 Maximum v/c Ratio: 0.73
 Intersection Signal Delay: 26.2 Intersection LOS: C
 Intersection Capacity Utilization 69.1% ICU Level of Service C
 Analysis Period (min) 15
 # 95th percentile volume exceeds capacity, queue may be longer.
 Queue shown is maximum after two cycles.
 m Volume for 95th percentile queue is metered by upstream signal.

Splits and Phases: 2: NC 86 (N. Columbia St) & W. Rosemary Street/E. Rosemary Street

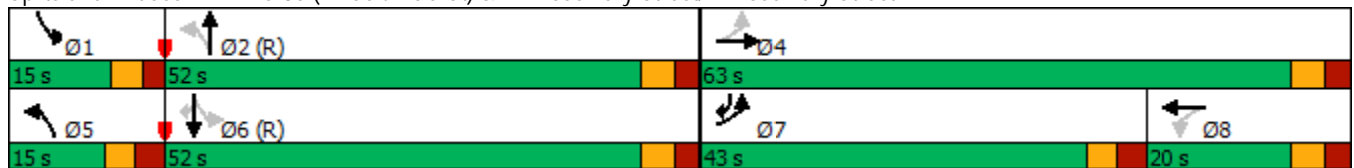

Lanes, Volumes, Timings

6: Henderson Street & E. Rosemary Street

09/01/2020



Lane Group	EBL	EBT	EBR	WBL	WBT	WBR	NBL	NBT	NBR	SBL	SBT	SBR
Lane Configurations												
Traffic Volume (vph)	15	192	123	15	206	31	56	30	11	9	38	13
Future Volume (vph)	15	192	123	15	206	31	56	30	11	9	38	13
Ideal Flow (vphpl)	1900	1900	1900	1900	1900	1900	1900	1900	1900	1900	1900	1900
Grade (%)		0%			0%			0%				3%
Storage Length (ft)	85		0	0		0	0		0	0		0
Storage Lanes	1		0	0		0	0		0	0		0
Taper Length (ft)	25			25			25			25		
Lane Util. Factor	1.00	1.00	1.00	1.00	1.00	1.00	1.00	1.00	1.00	1.00	1.00	1.00
Ped Bike Factor	0.96	0.97			0.99			0.85				0.93
Frt		0.941			0.983			0.985				0.971
Flt Protected	0.950				0.997			0.972				0.992
Satd. Flow (prot)	1593	1531	0	0	1627	0	0	1581	0	0	1497	0
Flt Permitted	0.595				0.977			0.782				0.941
Satd. Flow (perm)	960	1531	0	0	1591	0	0	1095	0	0	1400	0
Right Turn on Red			No			No			No			No
Satd. Flow (RTOR)												
Link Speed (mph)		20			20			20				20
Link Distance (ft)		500			1195			366				450
Travel Time (s)		17.0			40.7			12.5				15.3
Confl. Peds. (#/hr)	21		19	19		21	106		47	47		106
Peak Hour Factor	0.96	0.96	0.96	0.95	0.95	0.95	0.68	0.68	0.68	0.85	0.85	0.85
Adj. Flow (vph)	16	200	128	16	217	33	82	44	16	11	45	15
Shared Lane Traffic (%)												
Lane Group Flow (vph)	16	328	0	0	266	0	0	142	0	0	71	0
Turn Type	Perm	NA		Perm	NA		Perm	NA		Perm	NA	
Protected Phases		2			2			4				4
Permitted Phases	2			2			4			4		
Detector Phase	2	2		2	2		4	4		4		4
Switch Phase												
Minimum Initial (s)	11.0	11.0		11.0	11.0		8.0	8.0		8.0		8.0
Minimum Split (s)	15.9	15.9		15.9	15.9		17.8	17.8		17.8		17.8
Total Split (s)	38.0	38.0		38.0	38.0		27.0	27.0		27.0		27.0
Total Split (%)	58.5%	58.5%		58.5%	58.5%		41.5%	41.5%		41.5%		41.5%
Maximum Green (s)	33.1	33.1		33.1	33.1		22.2	22.2		22.2		22.2
Yellow Time (s)	3.3	3.3		3.3	3.3		3.3	3.3		3.3		3.3
All-Red Time (s)	1.6	1.6		1.6	1.6		1.5	1.5		1.5		1.5
Lost Time Adjust (s)	0.1	0.1			0.1			0.2				0.2
Total Lost Time (s)	5.0	5.0			5.0			5.0				5.0
Lead/Lag												
Lead-Lag Optimize?												
Vehicle Extension (s)	2.0	2.0		2.0	2.0		2.0	2.0		2.0		2.0
Recall Mode	C-Max	C-Max		C-Max	C-Max		None	None		None		None
Walk Time (s)	4.0	4.0		4.0	4.0		4.0	4.0		4.0		4.0
Flash Dont Walk (s)	7.0	7.0		7.0	7.0		9.0	9.0		9.0		9.0
Pedestrian Calls (#/hr)	0	0		0	0		0	0		0		0
Act Effct Green (s)	45.8	45.8			45.8			12.8				12.8
Actuated g/C Ratio	0.70	0.70			0.70			0.20				0.20
v/c Ratio	0.02	0.30			0.24			0.66				0.26

Lanes, Volumes, Timings
 6: Henderson Street & E. Rosemary Street

09/01/2020



Lane Group	EBL	EBT	EBR	WBL	WBT	WBR	NBL	NBT	NBR	SBL	SBT	SBR
Control Delay	6.1	5.9			6.1			35.3			22.7	
Queue Delay	0.0	0.0			0.0			0.0			0.0	
Total Delay	6.1	5.9			6.1			35.3			22.7	
LOS	A	A			A			D			C	
Approach Delay		6.0			6.1			35.3			22.7	
Approach LOS		A			A			D			C	
Queue Length 50th (ft)	2	43			58			62			24	
Queue Length 95th (ft)	m9	115			107			66			46	
Internal Link Dist (ft)		420			1115			286			370	
Turn Bay Length (ft)	85											
Base Capacity (vph)	676	1078			1120			370			473	
Starvation Cap Reductn	0	0			0			0			0	
Spillback Cap Reductn	0	0			0			0			0	
Storage Cap Reductn	0	0			0			0			0	
Reduced v/c Ratio	0.02	0.30			0.24			0.38			0.15	

Intersection Summary

Area Type: CBD
 Cycle Length: 65
 Actuated Cycle Length: 65
 Offset: 63 (97%), Referenced to phase 2:EBWB, Start of Green
 Natural Cycle: 40
 Control Type: Actuated-Coordinated
 Maximum v/c Ratio: 0.66
 Intersection Signal Delay: 12.5
 Intersection LOS: B
 Intersection Capacity Utilization 49.7%
 ICU Level of Service A
 Analysis Period (min) 15
 m Volume for 95th percentile queue is metered by upstream signal.

Splits and Phases: 6: Henderson Street & E. Rosemary Street



Lanes, Volumes, Timings
7: Hillsborough Street & E. Rosemary Street

09/01/2020



Lane Group	EBL	EBT	EBR	WBL	WBT	WBR	NBL	NBT	NBR	SBL	SBT	SBR
Lane Configurations		↕			↕		↗	↘		↗	↘	
Traffic Volume (vph)	23	91	86	3	52	9	164	181	9	16	220	25
Future Volume (vph)	23	91	86	3	52	9	164	181	9	16	220	25
Ideal Flow (vphp)	1900	1900	1900	1900	1900	1900	1900	1900	1900	1900	1900	1900
Storage Length (ft)	0		0	0		0	100		0	100		0
Storage Lanes	0		0	0		0	1		0	1		0
Taper Length (ft)	25			25			25			25		
Lane Util. Factor	1.00	1.00	1.00	1.00	1.00	1.00	1.00	1.00	1.00	1.00	1.00	1.00
Ped Bike Factor		0.95			0.98		0.93	1.00		0.99	0.98	
Frt		0.942			0.980			0.993			0.985	
Flt Protected		0.994			0.998		0.950			0.950		
Satd. Flow (prot)	0	1674	0	0	1792	0	1770	1847	0	1719	1750	0
Flt Permitted		0.956			0.982		0.487			0.623		
Satd. Flow (perm)	0	1594	0	0	1759	0	843	1847	0	1114	1750	0
Right Turn on Red			No			No			No			No
Satd. Flow (RTOR)												
Link Speed (mph)		20			20			25			25	
Link Distance (ft)		1195			527			363			726	
Travel Time (s)		40.7			18.0			9.9			19.8	
Confl. Peds. (#/hr)	35		35	35		35	50		5	5		50
Peak Hour Factor	0.93	0.93	0.93	0.78	0.78	0.78	0.88	0.88	0.88	0.91	0.91	0.91
Heavy Vehicles (%)	2%	2%	2%	2%	2%	2%	2%	2%	2%	5%	5%	5%
Adj. Flow (vph)	25	98	92	4	67	12	186	206	10	18	242	27
Shared Lane Traffic (%)												
Lane Group Flow (vph)	0	215	0	0	83	0	186	216	0	18	269	0
Turn Type	Perm	NA		Perm	NA		pm+pt	NA		Perm	NA	
Protected Phases		4			8		5	2			6	
Permitted Phases	4			8			2			6		
Detector Phase	4	4		8	8		5	2		6	6	
Switch Phase												
Minimum Initial (s)	7.0	7.0		7.0	7.0		7.0	10.0		10.0	10.0	
Minimum Split (s)	20.0	20.0		17.0	17.0		12.0	15.0		15.0	15.0	
Total Split (s)	24.0	24.0		24.0	24.0		13.0	41.0		28.0	28.0	
Total Split (%)	36.9%	36.9%		36.9%	36.9%		20.0%	63.1%		43.1%	43.1%	
Maximum Green (s)	19.1	19.1		19.0	19.0		8.2	36.2		23.2	23.2	
Yellow Time (s)	3.0	3.0		3.3	3.3		3.0	3.3		3.1	3.1	
All-Red Time (s)	1.9	1.9		1.7	1.7		1.8	1.5		1.7	1.7	
Lost Time Adjust (s)		0.1			0.0		0.2	0.2		0.2	0.2	
Total Lost Time (s)		5.0			5.0		5.0	5.0		5.0	5.0	
Lead/Lag							Lead			Lag	Lag	
Lead-Lag Optimize?												
Vehicle Extension (s)	2.0	2.0		2.0	2.0		2.0	2.0		2.0	2.0	
Recall Mode	None	None		None	None		None	C-Max		C-Max	C-Max	
Walk Time (s)	4.0	4.0		4.0	4.0			4.0		4.0	4.0	
Flash Dont Walk (s)	11.0	11.0		8.0	8.0			6.0		6.0	6.0	
Pedestrian Calls (#/hr)	0	0		0	0			0		0	0	
Act Effct Green (s)		12.9			12.9		42.1	42.1		29.6	29.6	
Actuated g/C Ratio		0.20			0.20		0.65	0.65		0.46	0.46	
v/c Ratio		0.68			0.24		0.28	0.18		0.04	0.34	

Lanes, Volumes, Timings
 7: Hillsborough Street & E. Rosemary Street

09/01/2020



Lane Group	EBL	EBT	EBR	WBL	WBT	WBR	NBL	NBT	NBR	SBL	SBT	SBR
Control Delay		33.6			21.9		6.3	5.6		12.8	14.5	
Queue Delay		0.0			0.0		0.0	0.0		0.0	0.0	
Total Delay		33.6			21.9		6.3	5.6		12.8	14.5	
LOS		C			C		A	A		B	B	
Approach Delay		33.6			21.9			5.9			14.4	
Approach LOS		C			C			A			B	
Queue Length 50th (ft)		81			28		49	57		4	64	
Queue Length 95th (ft)		111			47		70	81		17	139	
Internal Link Dist (ft)		1115			447			283			646	
Turn Bay Length (ft)							100			100		
Base Capacity (vph)		465			514		663	1196		508	798	
Starvation Cap Reductn		0			0		0	0		0	0	
Spillback Cap Reductn		0			0		0	0		0	0	
Storage Cap Reductn		0			0		0	0		0	0	
Reduced v/c Ratio		0.46			0.16		0.28	0.18		0.04	0.34	

Intersection Summary

Area Type: Other
 Cycle Length: 65
 Actuated Cycle Length: 65
 Offset: 19 (29%), Referenced to phase 2:NBTL and 6:SBTL, Start of Green
 Natural Cycle: 50
 Control Type: Actuated-Coordinated
 Maximum v/c Ratio: 0.68
 Intersection Signal Delay: 15.7
 Intersection Capacity Utilization 54.4%
 Analysis Period (min) 15

Intersection LOS: B
 ICU Level of Service A

Splits and Phases: 7: Hillsborough Street & E. Rosemary Street

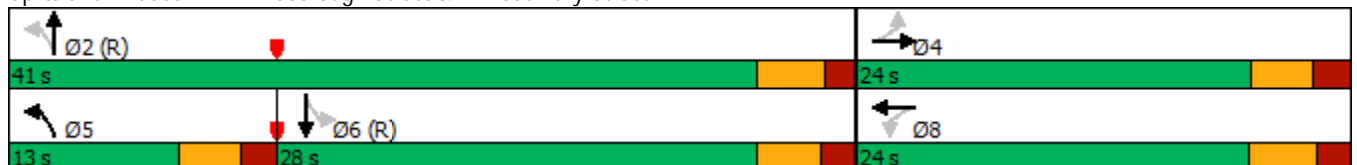

Lanes, Volumes, Timings

8: Carolina Square Driveway/Church Street & W. Franklin Street

09/01/2020



Lane Group	EBL	EBT	EBR	WBL	WBT	WBR	NBL	NBT	NBR	SBL	SBT	SBR
Lane Configurations												
Traffic Volume (vph)	53	364	26	32	334	69	10	10	22	23	23	58
Future Volume (vph)	53	364	26	32	334	69	10	10	22	23	23	58
Ideal Flow (vphpl)	1900	1900	1900	1900	1900	1900	1900	1900	1900	1900	1900	1900
Lane Width (ft)	10	10	16	10	10	10	12	12	12	12	12	12
Grade (%)		2%			-2%			-4%				-3%
Storage Length (ft)	150		0	200		0	0		100	0		0
Storage Lanes	1		0	1		0	0		1	0		0
Taper Length (ft)	25			25			25			25		
Lane Util. Factor	1.00	1.00	1.00	1.00	1.00	1.00	1.00	1.00	1.00	1.00	1.00	1.00
Ped Bike Factor	0.84	0.97		0.78	0.93			0.86	0.87		0.78	
Frt		0.990			0.974				0.850		0.924	
Flt Protected	0.950			0.950				0.976			0.989	
Satd. Flow (prot)	1443	1453	0	1472	1409	0	0	1669	1454	0	1204	0
Flt Permitted	0.477			0.474				0.827			0.926	
Satd. Flow (perm)	612	1453	0	576	1409	0	0	1220	1262	0	1100	0
Right Turn on Red			No			No			No			No
Satd. Flow (RTOR)												
Link Speed (mph)		20			20			20			25	
Link Distance (ft)		993			298			285			379	
Travel Time (s)		33.9			10.2			9.7			10.3	
Confl. Peds. (#/hr)	150		248	248		150	225		77	77		225
Peak Hour Factor	0.87	0.87	0.87	0.91	0.91	0.91	0.81	0.81	0.81	0.71	0.71	0.71
Heavy Vehicles (%)	4%	4%	4%	4%	4%	4%	2%	2%	2%	5%	5%	5%
Adj. Flow (vph)	61	418	30	35	367	76	12	12	27	32	32	82
Shared Lane Traffic (%)												
Lane Group Flow (vph)	61	448	0	35	443	0	0	24	27	0	146	0
Turn Type	Perm	NA		Perm	NA		Perm	NA	Perm	Perm	NA	
Protected Phases		2			6			8				4
Permitted Phases	2			6			8		8	4		
Detector Phase	2	2		6	6		8	8	8	4	4	
Switch Phase												
Minimum Initial (s)	10.0	10.0		10.0	10.0		7.0	7.0	7.0	7.0	7.0	
Minimum Split (s)	22.0	22.0		19.0	19.0		29.0	29.0	29.0	27.0	27.0	
Total Split (s)	36.0	36.0		36.0	36.0		29.0	29.0	29.0	29.0	29.0	
Total Split (%)	55.4%	55.4%		55.4%	55.4%		44.6%	44.6%	44.6%	44.6%	44.6%	
Maximum Green (s)	30.4	30.4		30.4	30.4		22.7	22.7	22.7	23.0	23.0	
Yellow Time (s)	3.3	3.3		3.3	3.3		3.1	3.1	3.1	3.4	3.4	
All-Red Time (s)	2.3	2.3		2.3	2.3		3.2	3.2	3.2	2.6	2.6	
Lost Time Adjust (s)	-0.6	-0.6		-0.6	-0.6		-1.3	-1.3	-1.3	-1.0	-1.0	
Total Lost Time (s)	5.0	5.0		5.0	5.0		5.0	5.0	5.0	5.0	5.0	
Lead/Lag												
Lead-Lag Optimize?												
Vehicle Extension (s)	3.0	3.0		3.0	3.0		2.0	2.0	2.0	2.0	2.0	
Recall Mode	C-Max	C-Max		C-Max	C-Max		None	None	None	None	None	
Walk Time (s)	7.0	7.0		7.0	7.0		7.0	7.0	7.0	7.0	7.0	
Flash Dont Walk (s)	9.0	9.0		6.0	6.0		15.0	15.0	15.0	14.0	14.0	
Pedestrian Calls (#/hr)	0	0		0	0		0	0	0	0	0	
Act Effect Green (s)	44.6	44.6		44.6	44.6		14.1	14.1	14.1	14.1	14.0	

Lanes, Volumes, Timings

8: Carolina Square Driveway/Church Street & W. Franklin Street

09/01/2020



Lane Group	EBL	EBT	EBR	WBL	WBT	WBR	NBL	NBT	NBR	SBL	SBT	SBR
Actuated g/C Ratio	0.69	0.69		0.69	0.69			0.22	0.22		0.22	
v/c Ratio	0.15	0.45		0.09	0.46			0.09	0.10		0.62	
Control Delay	7.8	9.3		8.3	10.7			18.5	18.6		32.3	
Queue Delay	0.0	0.0		0.0	0.0			0.0	0.0		0.0	
Total Delay	7.8	9.3		8.3	10.7			18.5	18.6		32.3	
LOS	A	A		A	B			B	B		C	
Approach Delay		9.1			10.6			18.6			32.3	
Approach LOS		A			B			B			C	
Queue Length 50th (ft)	9	81		3	49			8	9		62	
Queue Length 95th (ft)	30	181		m27	334			19	21		63	
Internal Link Dist (ft)		913			218			205			299	
Turn Bay Length (ft)	150			200					100			
Base Capacity (vph)	419	996		395	965			450	465		406	
Starvation Cap Reductn	0	0		0	0			0	0		0	
Spillback Cap Reductn	0	0		0	0			0	0		0	
Storage Cap Reductn	0	0		0	0			0	0		0	
Reduced v/c Ratio	0.15	0.45		0.09	0.46			0.05	0.06		0.36	

Intersection Summary

Area Type: CBD
 Cycle Length: 65
 Actuated Cycle Length: 65
 Offset: 2 (3%), Referenced to phase 2:EBTL and 6:WBTL, Start of Green
 Natural Cycle: 60
 Control Type: Actuated-Coordinated
 Maximum v/c Ratio: 0.62
 Intersection Signal Delay: 13.0 Intersection LOS: B
 Intersection Capacity Utilization 71.0% ICU Level of Service C
 Analysis Period (min) 15
 m Volume for 95th percentile queue is metered by upstream signal.

Splits and Phases: 8: Carolina Square Driveway/Church Street & W. Franklin Street

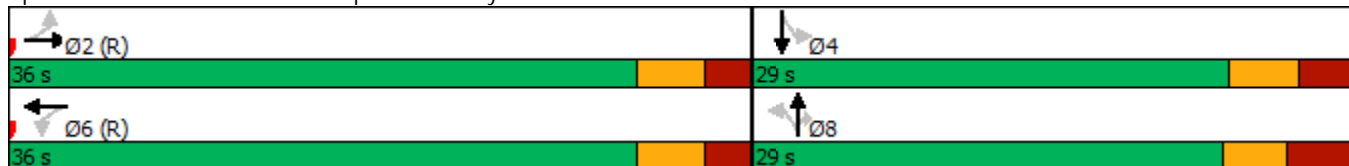

Lanes, Volumes, Timings

9: NC 86 (S. Columbia St)/NC 86 (N. Columbia St) & W. Franklin Street/E. Franklin Street 09/01/2020



Lane Group	EBL	EBT	EBR	WBL	WBT	WBR	NBL	NBT	NBR	SBL	SBT	SBR
Lane Configurations												
Traffic Volume (vph)	105	301	46	83	311	88	62	306	91	51	321	90
Future Volume (vph)	105	301	46	83	311	88	62	306	91	51	321	90
Ideal Flow (vphpl)	1900	1900	1900	1900	1900	1900	1900	1900	1900	1900	1900	1900
Lane Width (ft)	9	12	13	10	10	13	9	10	10	9	9	11
Grade (%)		3%			1%			-2%			3%	
Storage Length (ft)	250		0	125		0	475		0	125		0
Storage Lanes	1		0	1		1	1		0	1		0
Taper Length (ft)	25			25			25			25		
Lane Util. Factor	1.00	0.95	0.95	1.00	1.00	1.00	1.00	0.95	0.95	1.00	0.95	0.95
Ped Bike Factor	0.80	0.96		0.82		0.67	0.82	0.92		0.80	0.92	
Frt		0.980				0.850		0.966			0.967	
Flt Protected	0.950			0.950			0.950			0.950		
Satd. Flow (prot)	1372	2854	0	1437	1512	1423	1342	2468	0	1346	2398	0
Flt Permitted	0.950			0.950			0.950			0.950		
Satd. Flow (perm)	1097	2854	0	1179	1512	947	1105	2468	0	1083	2398	0
Right Turn on Red			No			No			No			No
Satd. Flow (RTOR)												
Link Speed (mph)		20			20			25			25	
Link Distance (ft)		457			941			981			353	
Travel Time (s)		15.6			32.1			26.8			9.6	
Confl. Peds. (#/hr)	251		248	248		251	117		321	321		117
Peak Hour Factor	0.80	0.80	0.80	0.87	0.87	0.87	0.93	0.93	0.93	0.85	0.85	0.85
Heavy Vehicles (%)	5%	5%	5%	5%	5%	5%	10%	10%	10%	7%	7%	7%
Adj. Flow (vph)	131	376	58	95	357	101	67	329	98	60	378	106
Shared Lane Traffic (%)												
Lane Group Flow (vph)	131	434	0	95	357	101	67	427	0	60	484	0
Turn Type	Prot	NA		Prot	NA	pm+ov	Prot	NA		Prot	NA	
Protected Phases	5	2		1	6	7	3	8		7	4	
Permitted Phases						6						
Detector Phase	5	2		1	6	7	3	8		7	4	
Switch Phase												
Minimum Initial (s)	7.0	10.0		7.0	10.0	7.0	7.0	7.0		7.0	7.0	
Minimum Split (s)	15.0	28.2		15.0	28.2	15.0	15.0	28.0		15.0	28.1	
Total Split (s)	25.0	32.0		25.0	32.0	25.0	25.0	48.0		25.0	48.0	
Total Split (%)	19.2%	24.6%		19.2%	24.6%	19.2%	19.2%	36.9%		19.2%	36.9%	
Maximum Green (s)	19.6	25.8		19.1	25.8	19.1	19.1	42.1		19.1	42.3	
Yellow Time (s)	3.0	3.0		3.0	3.0	3.0	3.0	3.3		3.0	3.1	
All-Red Time (s)	2.4	3.2		2.9	3.2	2.9	2.9	2.6		2.9	2.6	
Lost Time Adjust (s)	-0.4	-1.2		-0.9	-1.2	-2.0	-0.9	-0.9		-0.9	-0.7	
Total Lost Time (s)	5.0	5.0		5.0	5.0	3.9	5.0	5.0		5.0	5.0	
Lead/Lag	Lead	Lag		Lead	Lag	Lead	Lead	Lag		Lead	Lag	
Lead-Lag Optimize?												
Vehicle Extension (s)	1.0	3.0		1.0	3.0	1.0	1.0	2.0		1.0	2.0	
Recall Mode	None	C-Max		None	C-Max	None	None	Ped		None	Ped	
Walk Time (s)		7.0			7.0			7.0			7.0	
Flash Dont Walk (s)		15.0			15.0			15.0			15.0	
Pedestrian Calls (#/hr)		0			0			0			0	
Act Effect Green (s)	16.2	54.1		13.1	51.1	63.9	11.3	32.1		10.7	34.1	

Lanes, Volumes, Timings

9: NC 86 (S. Columbia St)/NC 86 (N. Columbia St) & W. Franklin Street/E. Franklin Street 09/01/2020



Lane Group	EBL	EBT	EBR	WBL	WBT	WBR	NBL	NBT	NBR	SBL	SBT	SBR
Actuated g/C Ratio	0.12	0.42		0.10	0.39	0.49	0.09	0.25		0.08	0.26	
v/c Ratio	0.77	0.37		0.66	0.60	0.20	0.58	0.70		0.55	0.77	
Control Delay	76.0	32.9		83.9	40.0	13.9	100.0	28.6		90.6	32.0	
Queue Delay	0.0	0.0		0.0	0.0	0.0	0.0	0.0		0.0	0.1	
Total Delay	76.0	32.9		83.9	40.0	13.9	100.0	28.6		90.6	32.1	
LOS	E	C		F	D	B	F	C		F	C	
Approach Delay		42.9			42.7			38.3			38.6	
Approach LOS		D			D			D			D	
Queue Length 50th (ft)	103	131		73	245	31	58	70		53	91	
Queue Length 95th (ft)	141	214		137	#491	70	108	66		95	90	
Internal Link Dist (ft)		377			861			901			273	
Turn Bay Length (ft)	250			125			475			125		
Base Capacity (vph)	218	1188		221	593	610	206	816		207	793	
Starvation Cap Reductn	0	0		0	0	0	0	0		0	14	
Spillback Cap Reductn	0	0		0	0	0	0	0		0	0	
Storage Cap Reductn	0	0		0	0	0	0	0		0	0	
Reduced v/c Ratio	0.60	0.37		0.43	0.60	0.17	0.33	0.52		0.29	0.62	

Intersection Summary

Area Type: CBD
 Cycle Length: 130
 Actuated Cycle Length: 130
 Offset: 0 (0%), Referenced to phase 2:EBT and 6:WBT, Start of Green
 Natural Cycle: 90
 Control Type: Actuated-Coordinated
 Maximum v/c Ratio: 0.77
 Intersection Signal Delay: 40.7 Intersection LOS: D
 Intersection Capacity Utilization 65.6% ICU Level of Service C
 Analysis Period (min) 15

95th percentile volume exceeds capacity, queue may be longer.
 Queue shown is maximum after two cycles.

Splits and Phases: 9: NC 86 (S. Columbia St)/NC 86 (N. Columbia St) & W. Franklin Street/E. Franklin Street

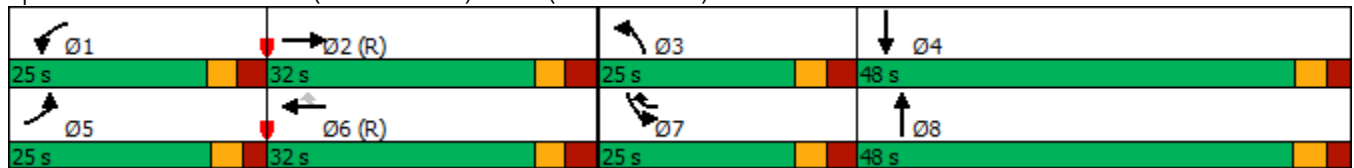

Lanes, Volumes, Timings
 10: E. Franklin Street & Henderson Street

09/01/2020



Lane Group	EBL	EBT	WBT	WBR	SBL	SBR
Lane Configurations		↕↕	↕↔		↔↕	
Traffic Volume (vph)	47	381	419	55	97	81
Future Volume (vph)	47	381	419	55	97	81
Ideal Flow (vphpl)	1900	1900	1900	1900	1900	1900
Lane Width (ft)	10	13	10	10	11	11
Grade (%)		-2%	2%		3%	
Lane Util. Factor	0.95	0.95	0.95	0.95	1.00	1.00
Ped Bike Factor		0.99	0.97		0.79	
Frt			0.983		0.938	
Flt Protected		0.995			0.974	
Satd. Flow (prot)	0	3213	2747	0	1245	0
Flt Permitted		0.862			0.974	
Satd. Flow (perm)	0	2748	2747	0	1154	0
Right Turn on Red				No		No
Satd. Flow (RTOR)						
Link Speed (mph)		20	20		20	
Link Distance (ft)		941	1200		366	
Travel Time (s)		32.1	40.9		12.5	
Confl. Peds. (#/hr)	119			119	130	370
Peak Hour Factor	0.95	0.95	0.92	0.92	0.87	0.87
Heavy Vehicles (%)	5%	5%	4%	4%	2%	2%
Parking (#/hr)						0
Adj. Flow (vph)	49	401	455	60	111	93
Shared Lane Traffic (%)						
Lane Group Flow (vph)	0	450	515	0	204	0
Turn Type	Perm	NA	NA		Prot	
Protected Phases		2	6		4	
Permitted Phases	2					
Detector Phase	2	2	6		4	
Switch Phase						
Minimum Initial (s)	10.0	10.0	10.0		7.0	
Minimum Split (s)	17.0	17.0	22.0		25.0	
Total Split (s)	32.0	32.0	32.0		33.0	
Total Split (%)	49.2%	49.2%	49.2%		50.8%	
Maximum Green (s)	25.8	25.8	25.9		27.9	
Yellow Time (s)	3.0	3.0	3.0		3.0	
All-Red Time (s)	3.2	3.2	3.1		2.1	
Lost Time Adjust (s)		-1.2	-1.1		-0.1	
Total Lost Time (s)		5.0	5.0		5.0	
Lead/Lag						
Lead-Lag Optimize?						
Vehicle Extension (s)	2.0	2.0	2.0		1.0	
Recall Mode	C-Max	C-Max	C-Max		None	
Walk Time (s)			7.0		7.0	
Flash Dont Walk (s)			8.0		12.0	
Pedestrian Calls (#/hr)			0		0	
Act Effct Green (s)		40.4	40.4		14.6	
Actuated g/C Ratio		0.62	0.62		0.22	
v/c Ratio		0.26	0.30		0.73	

Lanes, Volumes, Timings
 10: E. Franklin Street & Henderson Street

09/01/2020



Lane Group	EBL	EBT	WBT	WBR	SBL	SBR
Control Delay		6.8	7.8		36.0	
Queue Delay		0.0	0.0		0.0	
Total Delay		6.8	7.8		36.0	
LOS		A	A		D	
Approach Delay		6.8	7.8		36.0	
Approach LOS		A	A		D	
Queue Length 50th (ft)		15	36		90	
Queue Length 95th (ft)		161	143		125	
Internal Link Dist (ft)		861	1120		286	
Turn Bay Length (ft)						
Base Capacity (vph)		1708	1708		536	
Starvation Cap Reductn		0	0		0	
Spillback Cap Reductn		0	0		0	
Storage Cap Reductn		0	0		0	
Reduced v/c Ratio		0.26	0.30		0.38	

Intersection Summary

Area Type:	CBD
Cycle Length:	65
Actuated Cycle Length:	65
Offset:	4 (6%), Referenced to phase 2:EBTL and 6:WBT, Start of Green
Natural Cycle:	50
Control Type:	Actuated-Coordinated
Maximum v/c Ratio:	0.73
Intersection Signal Delay:	12.3
Intersection LOS:	B
Intersection Capacity Utilization:	57.1%
ICU Level of Service:	B
Analysis Period (min):	15

Splits and Phases: 10: E. Franklin Street & Henderson Street

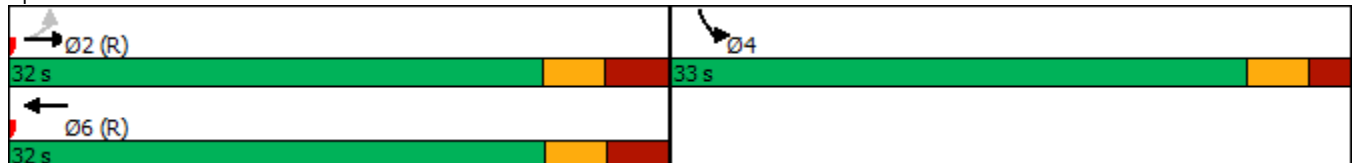

Lanes, Volumes, Timings

11: Raleigh Street/Hillsborough Street & E. Franklin Street

09/01/2020



Lane Group	EBL	EBT	EBR	WBL	WBT	WBR	NBL	NBT	NBR	SBL	SBT	SBR
Lane Configurations												
Traffic Volume (vph)	56	334	149	41	374	145	84	162	23	70	196	23
Future Volume (vph)	56	334	149	41	374	145	84	162	23	70	196	23
Ideal Flow (vphpl)	1900	1900	1900	1900	1900	1900	1900	1900	1900	1900	1900	1900
Lane Width (ft)	9	9	10	9	10	11	12	12	12	10	10	10
Grade (%)		1%			-2%			1%			1%	
Storage Length (ft)	75		0	75		0	0		0	100		0
Storage Lanes	1		0	1		0	0		0	1		0
Taper Length (ft)	25			25			25			25		
Lane Util. Factor	1.00	0.95	0.95	1.00	0.95	0.95	1.00	1.00	1.00	1.00	1.00	1.00
Ped Bike Factor	0.98	0.98		0.99	0.98			0.97		0.97	0.98	
Frt		0.954			0.958			0.989			0.984	
Flt Protected	0.950			0.950				0.985		0.950		
Satd. Flow (prot)	1539	2893	0	1593	3096	0	0	1795	0	1612	1639	0
Flt Permitted	0.409			0.430				0.665		0.495		
Satd. Flow (perm)	647	2893	0	712	3096	0	0	1183	0	814	1639	0
Right Turn on Red			No			No			No			No
Satd. Flow (RTOR)												
Link Speed (mph)		20			30			25			25	
Link Distance (ft)		1200			1013			995			363	
Travel Time (s)		40.9			23.0			27.1			9.9	
Confl. Peds. (#/hr)	50		25	25		50	93		33	33		93
Peak Hour Factor	0.91	0.91	0.91	0.91	0.91	0.91	0.94	0.94	0.94	0.90	0.90	0.90
Heavy Vehicles (%)	5%	5%	5%	3%	3%	3%	2%	2%	2%	4%	4%	4%
Adj. Flow (vph)	62	367	164	45	411	159	89	172	24	78	218	26
Shared Lane Traffic (%)												
Lane Group Flow (vph)	62	531	0	45	570	0	0	285	0	78	244	0
Turn Type	Perm	NA		Perm	NA		pm+pt	NA		D.Pm	NA	
Protected Phases		2			6		7	4				8
Permitted Phases	2			6			4			4		
Detector Phase	2	2		6	6		7	4		4		8
Switch Phase												
Minimum Initial (s)	10.0	10.0		10.0	10.0		7.0	7.0		7.0	7.0	
Minimum Split (s)	16.0	16.0		16.0	16.0		14.0	30.0		30.0	29.0	
Total Split (s)	60.0	60.0		60.0	60.0		31.0	70.0		70.0	39.0	
Total Split (%)	46.2%	46.2%		46.2%	46.2%		23.8%	53.8%		53.8%	30.0%	
Maximum Green (s)	54.7	54.7		54.7	54.7		24.8	63.6		63.6	32.6	
Yellow Time (s)	3.0	3.0		3.0	3.0		3.0	3.1		3.1	3.1	
All-Red Time (s)	2.3	2.3		2.3	2.3		3.2	3.3		3.3	3.3	
Lost Time Adjust (s)	-0.3	-0.3		-0.3	-0.3			-1.4		-1.4	-1.4	
Total Lost Time (s)	5.0	5.0		5.0	5.0			5.0		5.0	5.0	
Lead/Lag							Lead				Lag	
Lead-Lag Optimize?												
Vehicle Extension (s)	3.0	3.0		3.0	3.0		3.0	2.0		2.0	2.0	
Recall Mode	C-Max	C-Max		C-Max	C-Max		None	None		None	None	
Walk Time (s)								7.0		7.0	7.0	
Flash Dont Walk (s)								16.0		16.0	15.0	
Pedestrian Calls (#/hr)								0		0	0	
Act Effect Green (s)	79.3	79.3		79.3	79.3			40.7		40.7	40.7	

Lanes, Volumes, Timings

11: Raleigh Street/Hillsborough Street & E. Franklin Street

09/01/2020



Lane Group	EBL	EBT	EBR	WBL	WBT	WBR	NBL	NBT	NBR	SBL	SBT	SBR
Actuated g/C Ratio	0.61	0.61		0.61	0.61			0.31		0.31	0.31	
v/c Ratio	0.16	0.30		0.10	0.30			0.77		0.31	0.48	
Control Delay	13.9	11.6		14.8	14.2			53.3		32.4	36.8	
Queue Delay	0.0	0.0		0.0	0.0			0.0		0.0	4.3	
Total Delay	13.9	11.6		14.8	14.2			53.3		32.4	41.1	
LOS	B	B		B	B			D		C	D	
Approach Delay		11.9			14.3			53.3			39.0	
Approach LOS		B			B			D			D	
Queue Length 50th (ft)	13	64		15	114			217		47	157	
Queue Length 95th (ft)	54	161		44	194			278		79	203	
Internal Link Dist (ft)		1120			933			915			283	
Turn Bay Length (ft)	75			75						100		
Base Capacity (vph)	394	1764		434	1888			591		407	532	
Starvation Cap Reductn	0	0		0	0			0		0	212	
Spillback Cap Reductn	0	0		0	0			0		0	0	
Storage Cap Reductn	0	0		0	0			0		0	0	
Reduced v/c Ratio	0.16	0.30		0.10	0.30			0.48		0.19	0.76	

Intersection Summary





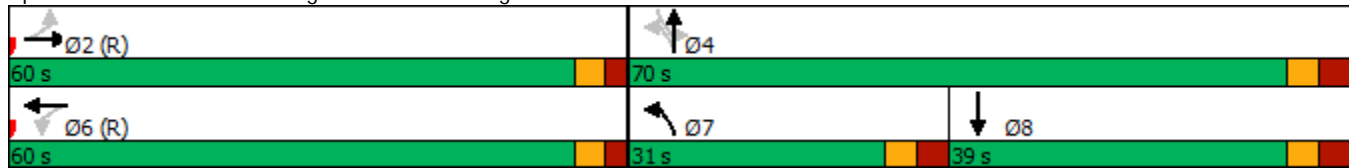













Area Type:	Other
Cycle Length:	130
Actuated Cycle Length:	130
Offset:	57 (44%), Referenced to phase 2:EBTL and 6:WBTL, Start of Green
Natural Cycle:	60
Control Type:	Actuated-Coordinated
Maximum v/c Ratio:	0.77
Intersection Signal Delay:	24.0
Intersection LOS:	C
Intersection Capacity Utilization	76.9%
ICU Level of Service	D
Analysis Period (min)	15

Splits and Phases: 11: Raleigh Street/Hillsborough Street & E. Franklin Street



Lanes, Volumes, Timings

13: NC 86 (N. Columbia St)/NC 86 (MLK Jr. Blvd) & North Street & N. Columbia Street 09/01/2020

												
Lane Group	WBL	WBR	WBR2	NBL	NBT	NBR	SBL	SBT	SBR	SEL2	SEL	SER
Lane Configurations												
Traffic Volume (vph)	8	9	85	44	459	4	63	520	6	1	7	60
Future Volume (vph)	8	9	85	44	459	4	63	520	6	1	7	60
Ideal Flow (vphpl)	1900	1900	1900	1900	1900	1900	1900	1900	1900	1900	1900	1900
Grade (%)	2%				-5%			5%				-3%
Storage Length (ft)	0	0		150		0	70		0		0	0
Storage Lanes	1	0		1		0	1		0		1	0
Taper Length (ft)	25			25			25				25	
Lane Util. Factor	1.00	1.00	1.00	1.00	0.95	0.95	1.00	0.95	0.95	1.00	1.00	1.00
Ped Bike Factor	0.98			1.00	1.00		0.98	1.00			1.00	
Frt	0.876				0.999			0.998				0.880
Flt Protected	0.996			0.950			0.950				0.994	
Satd. Flow (prot)	1578	0	0	1729	3453	0	1676	3344	0	0	1562	0
Flt Permitted	0.996			0.395			0.451				0.994	
Satd. Flow (perm)	1578	0	0	717	3453	0	778	3344	0	0	1560	0
Right Turn on Red			No			No			No			No
Satd. Flow (RTOR)												
Link Speed (mph)	20				35			35				25
Link Distance (ft)	264				476			2108				715
Travel Time (s)	9.0				9.3			41.1				19.5
Confl. Peds. (#/hr)			8	6		41	41		6	8		
Peak Hour Factor	0.75	0.75	0.75	0.93	0.93	0.93	0.87	0.87	0.87	0.75	0.75	0.75
Heavy Vehicles (%)	2%	2%	2%	7%	7%	7%	5%	5%	5%	8%	8%	8%
Adj. Flow (vph)	11	12	113	47	494	4	72	598	7	1	9	80
Shared Lane Traffic (%)												
Lane Group Flow (vph)	136	0	0	47	498	0	72	605	0	0	90	0
Turn Type	Prot			Perm	NA		Perm	NA		Prot	Prot	
Protected Phases	3				2			6		4	4	
Permitted Phases				2			6					
Detector Phase	3			2	2		6	6		4	4	
Switch Phase												
Minimum Initial (s)	7.0			10.0	10.0		10.0	10.0		7.0	7.0	
Minimum Split (s)	14.0			17.0	17.0		17.0	17.0		14.0	14.0	
Total Split (s)	39.0			61.0	61.0		61.0	61.0		30.0	30.0	
Total Split (%)	30.0%			46.9%	46.9%		46.9%	46.9%		23.1%	23.1%	
Maximum Green (s)	32.0			54.0	54.0		54.0	54.0		23.0	23.0	
Yellow Time (s)	5.0			5.0	5.0		5.0	5.0		5.0	5.0	
All-Red Time (s)	2.0			2.0	2.0		2.0	2.0		2.0	2.0	
Lost Time Adjust (s)	-2.0			-2.0	-2.0		-2.0	-2.0			-2.0	
Total Lost Time (s)	5.0			5.0	5.0		5.0	5.0			5.0	
Lead/Lag	Lead									Lag	Lag	
Lead-Lag Optimize?	Yes									Yes	Yes	
Vehicle Extension (s)	3.0			3.0	3.0		3.0	3.0		3.0	3.0	
Recall Mode	None			C-Max	C-Max		C-Max	C-Max		None	None	
Act Effct Green (s)	18.5			81.7	81.7		81.7	81.7			14.8	
Actuated g/C Ratio	0.14			0.63	0.63		0.63	0.63			0.11	
v/c Ratio	0.60			0.10	0.23		0.15	0.29			0.51	
Control Delay	63.0			11.7	10.1		13.1	12.5			63.3	
Queue Delay	0.0			0.0	0.0		0.0	0.0			0.0	

Lanes, Volumes, Timings

13: NC 86 (N. Columbia St)/NC 86 (MLK Jr. Blvd) & North Street & N. Columbia Street 09/01/2020



Lane Group	WBL	WBR	WBR2	NBL	NBT	NBR	SBL	SBT	SBR	SEL2	SEL	SER
Total Delay	63.0			11.7	10.1		13.1	12.5			63.3	
LOS	E			B	B		B	B			E	
Approach Delay	63.0				10.2			12.6			63.3	
Approach LOS	E				B			B			E	
Queue Length 50th (ft)	109			12	68		23	114			72	
Queue Length 95th (ft)	138			m28	97		56	178			102	
Internal Link Dist (ft)	184				396			2028			635	
Turn Bay Length (ft)				150			70					
Base Capacity (vph)	412			450	2169		488	2100			300	
Starvation Cap Reductn	0			0	0		0	0			0	
Spillback Cap Reductn	0			0	0		0	0			0	
Storage Cap Reductn	0			0	0		0	0			0	
Reduced v/c Ratio	0.33			0.10	0.23		0.15	0.29			0.30	

Intersection Summary

Area Type: Other
 Cycle Length: 130
 Actuated Cycle Length: 130
 Offset: 66 (51%), Referenced to phase 2:NBTL and 6:SBTL, Start of Green
 Natural Cycle: 45
 Control Type: Actuated-Coordinated
 Maximum v/c Ratio: 0.60
 Intersection Signal Delay: 19.6 Intersection LOS: B
 Intersection Capacity Utilization 52.4% ICU Level of Service A
 Analysis Period (min) 15
 m Volume for 95th percentile queue is metered by upstream signal.

Splits and Phases: 13: NC 86 (N. Columbia St)/NC 86 (MLK Jr. Blvd) & North Street & N. Columbia Street

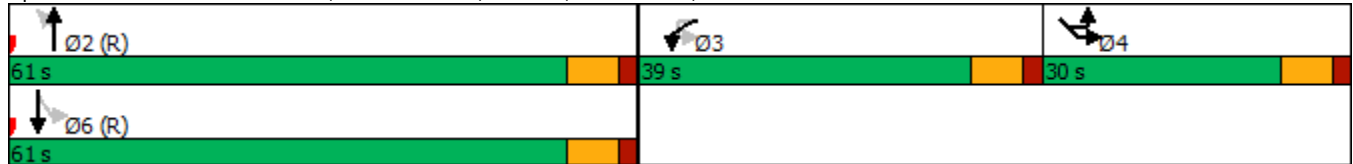

Lanes, Volumes, Timings

14: NC 86 (MLK Jr. Blvd) & Longview Street/Mill Creek Apts Driveway

09/01/2020

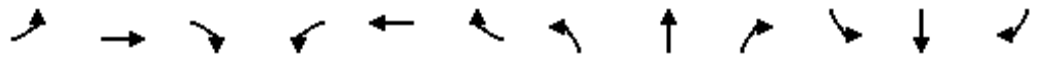

Lane Group	EBL	EBT	EBR	WBL	WBT	WBR	NBL	NBT	NBR	SBL	SBT	SBR
Lane Configurations		↕			↕		↕	↕		↕	↕	
Traffic Volume (vph)	37	0	19	4	0	2	7	514	8	1	565	35
Future Volume (vph)	37	0	19	4	0	2	7	514	8	1	565	35
Ideal Flow (vphpl)	1900	1900	1900	1900	1900	1900	1900	1900	1900	1900	1900	1900
Grade (%)		-6%			1%			2%			-4%	
Storage Length (ft)	0		0	0		0	225		0	250		0
Storage Lanes	0		0	0		0	1		0	1		0
Taper Length (ft)	25			25			25			25		
Lane Util. Factor	1.00	1.00	1.00	1.00	1.00	1.00	1.00	0.95	0.95	1.00	0.95	0.95
Ped Bike Factor		0.99			0.98		0.99	1.00		0.98	1.00	
Frt		0.954			0.955			0.998			0.991	
Flt Protected		0.968			0.968		0.950			0.950		
Satd. Flow (prot)	0	1720	0	0	1706	0	1670	3331	0	1753	3468	0
Flt Permitted		0.794			0.754		0.401			0.431		
Satd. Flow (perm)	0	1410	0	0	1314	0	700	3331	0	782	3468	0
Right Turn on Red			No			No			No			No
Satd. Flow (RTOR)												
Link Speed (mph)		25			20			35			35	
Link Distance (ft)		451			338			2108			784	
Travel Time (s)		12.3			11.5			41.1			15.3	
Confl. Peds. (#/hr)	1		19	19		1	7		15	15		7
Peak Hour Factor	0.76	0.76	0.76	0.50	0.50	0.50	0.89	0.89	0.89	0.91	0.91	0.91
Heavy Vehicles (%)	4%	4%	4%	2%	2%	2%	7%	7%	7%	5%	5%	5%
Adj. Flow (vph)	49	0	25	8	0	4	8	578	9	1	621	38
Shared Lane Traffic (%)												
Lane Group Flow (vph)	0	74	0	0	12	0	8	587	0	1	659	0
Turn Type	Perm	NA		Perm	NA		Perm	NA		Perm	NA	
Protected Phases		4			8			2			6	
Permitted Phases	4			8			2			6		
Detector Phase	4	4		8	8		2	2		6	6	
Switch Phase												
Minimum Initial (s)	7.0	7.0		7.0	7.0		12.0	12.0		12.0	12.0	
Minimum Split (s)	31.0	31.0		14.0	14.0		28.0	28.0		28.0	28.0	
Total Split (s)	20.0	20.0		20.0	20.0		60.0	60.0		60.0	60.0	
Total Split (%)	25.0%	25.0%		25.0%	25.0%		75.0%	75.0%		75.0%	75.0%	
Maximum Green (s)	14.0	14.0		13.9	13.9		54.0	54.0		54.5	54.5	
Yellow Time (s)	3.5	3.5		3.0	3.0		4.5	4.5		4.0	4.0	
All-Red Time (s)	2.5	2.5		3.1	3.1		1.5	1.5		1.5	1.5	
Lost Time Adjust (s)		-1.0			-1.0		-1.0	-1.0		-0.5	-0.5	
Total Lost Time (s)		5.0			5.1		5.0	5.0		5.0	5.0	
Lead/Lag												
Lead-Lag Optimize?												
Vehicle Extension (s)	3.0	3.0		3.0	3.0		3.0	3.0		3.0	3.0	
Recall Mode	None	None		None	None		Min	Min		Min	Min	
Walk Time (s)	7.0	7.0					7.0	7.0		7.0	7.0	
Flash Dont Walk (s)	17.0	17.0					9.0	9.0		9.0	9.0	
Pedestrian Calls (#/hr)	0	0					0	0		0	0	
Act Effct Green (s)		8.7			8.6		24.5	24.5		24.5	24.5	
Actuated g/C Ratio		0.25			0.24		0.69	0.69		0.69	0.69	

Lanes, Volumes, Timings

14: NC 86 (MLK Jr. Blvd) & Longview Street/Mill Creek Apts Driveway

09/01/2020



Lane Group	EBL	EBT	EBR	WBL	WBT	WBR	NBL	NBT	NBR	SBL	SBT	SBR
v/c Ratio		0.21			0.04		0.02	0.26		0.00	0.28	
Control Delay		12.8			10.8		5.4	5.1		5.0	5.1	
Queue Delay		0.0			0.0		0.0	0.0		0.0	0.0	
Total Delay		12.8			10.8		5.4	5.1		5.0	5.1	
LOS		B			B		A	A		A	A	
Approach Delay		12.8			10.8			5.1			5.1	
Approach LOS		B			B			A			A	
Queue Length 50th (ft)		14			2		1	32		0	36	
Queue Length 95th (ft)		28			5		5	60		2	68	
Internal Link Dist (ft)		371			258			2028			704	
Turn Bay Length (ft)							225			250		
Base Capacity (vph)		599			554		700	3331		782	3468	
Starvation Cap Reductn		0			0		0	0		0	0	
Spillback Cap Reductn		0			0		0	0		0	0	
Storage Cap Reductn		0			0		0	0		0	0	
Reduced v/c Ratio		0.12			0.02		0.01	0.18		0.00	0.19	

Intersection Summary

Area Type:	Other
Cycle Length:	80
Actuated Cycle Length:	35.5
Natural Cycle:	60
Control Type:	Actuated-Uncoordinated
Maximum v/c Ratio:	0.28
Intersection Signal Delay:	5.6
Intersection LOS:	A
Intersection Capacity Utilization:	37.6%
ICU Level of Service:	A
Analysis Period (min):	15

Splits and Phases: 14: NC 86 (MLK Jr. Blvd) & Longview Street/Mill Creek Apts Driveway



Lanes, Volumes, Timings
 15: NC 86 (Pittsboro St) & W. Cameron Avenue

09/01/2020



Lane Group	EBT	EBR	WBL	WBT	NBL	NBR	Ø1	Ø4
Lane Configurations	↻		↻↻	↻				
Traffic Volume (vph)	79	154	455	217	0	0		
Future Volume (vph)	79	154	455	217	0	0		
Ideal Flow (vphpl)	1900	1900	1900	1900	1900	1900		
Lane Width (ft)	12	12	11	12	12	12		
Grade (%)	3%			-3%	0%			
Storage Length (ft)		0	75		0	0		
Storage Lanes		0	0		0	0		
Taper Length (ft)			25		25			
Lane Util. Factor	1.00	1.00	0.97	1.00	1.00	1.00		
Ped Bike Factor	0.78		0.65					
Frt	0.911							
Flt Protected			0.950					
Satd. Flow (prot)	1169	0	2837	1592	0	0		
Flt Permitted			0.950					
Satd. Flow (perm)	1169	0	1843	1592	0	0		
Right Turn on Red		No				No		
Satd. Flow (RTOR)								
Link Speed (mph)	25			25	25			
Link Distance (ft)	391			120	794			
Travel Time (s)	30.0			10.7	21.7			
Confl. Peds. (#/hr)		129	129					
Peak Hour Factor	0.71	0.71	0.93	0.93	0.90	0.90		
Heavy Vehicles (%)	2%	2%	9%	9%	2%	2%		
Adj. Flow (vph)	111	217	489	233	0	0		
Shared Lane Traffic (%)								
Lane Group Flow (vph)	328	0	489	233	0	0		
Turn Type	NA		Prot	NA				
Protected Phases	2		1 4	6			1	4
Permitted Phases								
Detector Phase	2		1 4	6				
Switch Phase								
Minimum Initial (s)	10.0			10.0			7.0	7.0
Minimum Split (s)	20.0			20.0			20.0	20.0
Total Split (s)	77.0			110.0			33.0	20.0
Total Split (%)	59.2%			84.6%			25%	15%
Maximum Green (s)	71.9			105.0			27.9	16.0
Yellow Time (s)	3.0			3.3			3.0	3.0
All-Red Time (s)	2.1			1.7			2.1	1.0
Lost Time Adjust (s)	-0.1			0.0				
Total Lost Time (s)	5.0			5.0				
Lead/Lag	Lag						Lead	
Lead-Lag Optimize?								
Vehicle Extension (s)	1.0			1.0			4.0	0.2
Recall Mode	None			C-Max			C-Max	None
Walk Time (s)	7.0							7.0
Flash Dont Walk (s)	4.0							9.0
Pedestrian Calls (#/hr)	0							0
Act Effect Green (s)	72.0		48.0	105.4				

Lanes, Volumes, Timings
 15: NC 86 (Pittsboro St) & W. Cameron Avenue

09/01/2020



Lane Group	EBT	EBR	WBL	WBT	NBL	NBR	Ø1	Ø4
Actuated g/C Ratio	0.55		0.37	0.81				
v/c Ratio	0.51		0.47	0.18				
Control Delay	21.4		26.3	3.3				
Queue Delay	0.0		1.2	0.6				
Total Delay	21.4		27.4	3.8				
LOS	C		C	A				
Approach Delay	21.4			19.8				
Approach LOS	C			B				
Queue Length 50th (ft)	165		162	30				
Queue Length 95th (ft)	176		245	m65				
Internal Link Dist (ft)	311			40	714			
Turn Bay Length (ft)			75					
Base Capacity (vph)	647		1035	1290				
Starvation Cap Reductn	0		325	719				
Spillback Cap Reductn	0		0	0				
Storage Cap Reductn	0		0	0				
Reduced v/c Ratio	0.51		0.69	0.41				

Intersection Summary

Area Type:	CBD
Cycle Length:	130
Actuated Cycle Length:	130
Offset:	28 (22%), Referenced to phase 1:WBL and 6:WBT, Start of Green
Natural Cycle:	65
Control Type:	Actuated-Coordinated
Maximum v/c Ratio:	0.51
Intersection Signal Delay:	20.3
Intersection LOS:	C
Intersection Capacity Utilization:	42.3%
ICU Level of Service:	A
Analysis Period (min):	15
m Volume for 95th percentile queue is metered by upstream signal.	

Splits and Phases: 15: NC 86 (Pittsboro St) & W. Cameron Avenue

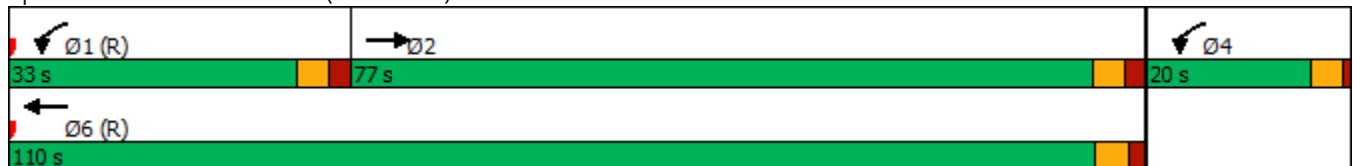

Lanes, Volumes, Timings

16: NC 86 (S. Columbia St) & W. Cameron Avenue/E. Cameron Avenue

09/01/2020



Lane Group	EBL	EBT	EBR	WBL	WBT	WBR	NBL	NBT	NBR	SBL	SBT	SBR
Lane Configurations												
Traffic Volume (vph)	20	52	0	0	91	37	171	388	27	43	0	409
Future Volume (vph)	20	52	0	0	91	37	171	388	27	43	0	409
Ideal Flow (vphpl)	1900	1900	1900	1900	1900	1900	1900	1900	1900	1900	1900	1900
Lane Width (ft)	11	12	12	12	12	12	10	10	10	11	11	12
Grade (%)		1%			-1%			1%			2%	
Storage Length (ft)	100		0	0		0	0		0	310		0
Storage Lanes	1		0	0		0	1		0	1		2
Taper Length (ft)	25			25			25			25		
Lane Util. Factor	1.00	1.00	1.00	1.00	1.00	1.00	0.91	0.91	0.95	1.00	1.00	0.88
Ped Bike Factor	0.77				0.91		0.60	0.94		0.61		0.43
Frt					0.961			0.991				0.850
Flt Protected	0.950						0.950	0.998		0.950		
Satd. Flow (prot)	1488	1620	0	0	1404	0	1259	2496	0	1439	0	2345
Flt Permitted	0.487						0.950	0.998		0.950		
Satd. Flow (perm)	588	1620	0	0	1404	0	757	2456	0	882	0	1014
Right Turn on Red			No			No			No			No
Satd. Flow (RTOR)												
Link Speed (mph)		25			25			25			25	
Link Distance (ft)		273			989			826			981	
Travel Time (s)		10.7			57.6			22.5			26.8	
Confl. Peds. (#/hr)	207		358	358		207	244		349	349		244
Peak Hour Factor	0.93	0.93	0.93	0.84	0.84	0.84	0.86	0.86	0.86	0.86	0.86	0.86
Heavy Vehicles (%)	5%	5%	5%	7%	7%	7%	9%	9%	9%	8%	8%	8%
Adj. Flow (vph)	22	56	0	0	108	44	199	451	31	50	0	476
Shared Lane Traffic (%)							10%					
Lane Group Flow (vph)	22	56	0	0	152	0	179	502	0	50	0	476
Turn Type	Perm	NA			NA		Split	NA		Prot		Prot
Protected Phases		4			8		2	2		1		1
Permitted Phases	4									1		1
Detector Phase	4	4			8		2	2		1		1
Switch Phase												
Minimum Initial (s)	10.0	10.0			10.0		7.0	7.0		7.0		7.0
Minimum Split (s)	24.0	24.0			31.0		18.0	18.0		26.0		26.0
Total Split (s)	40.0	40.0			40.0		23.0	23.0		39.0		39.0
Total Split (%)	30.8%	30.8%			30.8%		17.7%	17.7%		30.0%		30.0%
Maximum Green (s)	33.8	33.8			33.8		17.1	17.1		33.4		33.4
Yellow Time (s)	3.2	3.2			3.2		3.1	3.1		3.0		3.0
All-Red Time (s)	3.0	3.0			3.0		2.8	2.8		2.6		2.6
Lost Time Adjust (s)	-1.2	-1.2			-1.2		-0.9	-0.9		-0.6		-0.6
Total Lost Time (s)	5.0	5.0			5.0		5.0	5.0		5.0		5.0
Lead/Lag							Lead	Lead		Lag		Lag
Lead-Lag Optimize?												
Vehicle Extension (s)	2.0	2.0			2.0		4.0	4.0		4.0		4.0
Recall Mode	None	None			None		C-Max	C-Max		None		None
Walk Time (s)	7.0	7.0			7.0		7.0	7.0		7.0		7.0
Flash Dont Walk (s)	10.0	10.0			17.0		5.0	5.0		13.0		13.0
Pedestrian Calls (#/hr)	0	0			0		0	0		0		0
Act Effect Green (s)	19.7	19.7			19.7		64.0	64.0		31.3		31.3

Lanes, Volumes, Timings

16: NC 86 (S. Columbia St) & W. Cameron Avenue/E. Cameron Avenue

09/01/2020

Lane Group	Ø9
Lane Configurations	
Traffic Volume (vph)	
Future Volume (vph)	
Ideal Flow (vphpl)	
Lane Width (ft)	
Grade (%)	
Storage Length (ft)	
Storage Lanes	
Taper Length (ft)	
Lane Util. Factor	
Ped Bike Factor	
Frt	
Flt Protected	
Satd. Flow (prot)	
Flt Permitted	
Satd. Flow (perm)	
Right Turn on Red	
Satd. Flow (RTOR)	
Link Speed (mph)	
Link Distance (ft)	
Travel Time (s)	
Confl. Peds. (#/hr)	
Peak Hour Factor	
Heavy Vehicles (%)	
Adj. Flow (vph)	
Shared Lane Traffic (%)	
Lane Group Flow (vph)	
Turn Type	
Protected Phases	9
Permitted Phases	
Detector Phase	
Switch Phase	
Minimum Initial (s)	7.0
Minimum Split (s)	28.0
Total Split (s)	28.0
Total Split (%)	22%
Maximum Green (s)	24.0
Yellow Time (s)	3.0
All-Red Time (s)	1.0
Lost Time Adjust (s)	
Total Lost Time (s)	
Lead/Lag	
Lead-Lag Optimize?	
Vehicle Extension (s)	0.2
Recall Mode	None
Walk Time (s)	7.0
Flash Dont Walk (s)	17.0
Pedestrian Calls (#/hr)	0
Act Effect Green (s)	

Lanes, Volumes, Timings

16: NC 86 (S. Columbia St) & W. Cameron Avenue/E. Cameron Avenue

09/01/2020

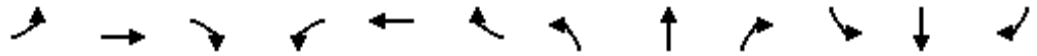

Lane Group	EBL	EBT	EBR	WBL	WBT	WBR	NBL	NBT	NBR	SBL	SBT	SBR
Actuated g/C Ratio	0.15	0.15			0.15		0.49	0.49		0.24		0.24
v/c Ratio	0.25	0.23			0.72		0.29	0.41		0.14		0.84
Control Delay	38.0	33.7			70.1		23.4	23.9		19.0		36.7
Queue Delay	0.0	0.0			0.0		0.0	0.0		0.0		0.0
Total Delay	38.0	33.7			70.1		23.4	23.9		19.0		36.7
LOS	D	C			E		C	C		B		D
Approach Delay		34.9			70.1			23.8			35.0	
Approach LOS		C			E			C			D	
Queue Length 50th (ft)	17	43			123		98	149		18		200
Queue Length 95th (ft)	m34	86			173		171	211		m34		261
Internal Link Dist (ft)		193			909			746			901	
Turn Bay Length (ft)	100									310		
Base Capacity (vph)	158	436			378		619	1228		376		613
Starvation Cap Reductn	0	0			0		0	0		0		0
Spillback Cap Reductn	0	0			0		0	0		0		0
Storage Cap Reductn	0	0			0		0	0		0		0
Reduced v/c Ratio	0.14	0.13			0.40		0.29	0.41		0.13		0.78

Intersection Summary

Area Type: CBD
 Cycle Length: 130
 Actuated Cycle Length: 130
 Offset: 67 (52%), Referenced to phase 2:NBTL, Start of Green
 Natural Cycle: 105
 Control Type: Actuated-Coordinated
 Maximum v/c Ratio: 0.84
 Intersection Signal Delay: 33.4 Intersection LOS: C
 Intersection Capacity Utilization 69.3% ICU Level of Service C
 Analysis Period (min) 15
 m Volume for 95th percentile queue is metered by upstream signal.

Splits and Phases: 16: NC 86 (S. Columbia St) & W. Cameron Avenue/E. Cameron Avenue

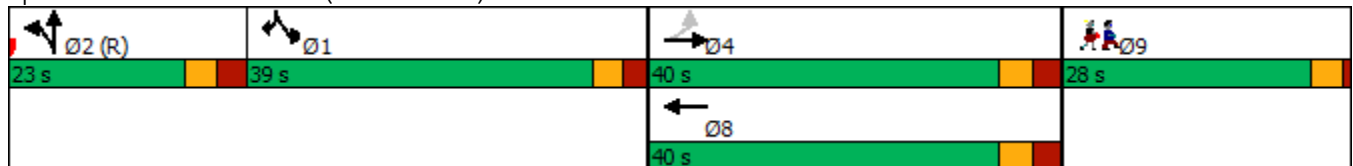

Lanes, Volumes, Timings

16: NC 86 (S. Columbia St) & W. Cameron Avenue/E. Cameron Avenue

09/01/2020

Lane Group	Ø9
Actuated g/C Ratio	
v/c Ratio	
Control Delay	
Queue Delay	
Total Delay	
LOS	
Approach Delay	
Approach LOS	
Queue Length 50th (ft)	
Queue Length 95th (ft)	
Internal Link Dist (ft)	
Turn Bay Length (ft)	
Base Capacity (vph)	
Starvation Cap Reductn	
Spillback Cap Reductn	
Storage Cap Reductn	
Reduced v/c Ratio	
Intersection Summary	

Lanes, Volumes, Timings

17: Raleigh Street & E. Cameron Avenue/Country Club Road

09/01/2020

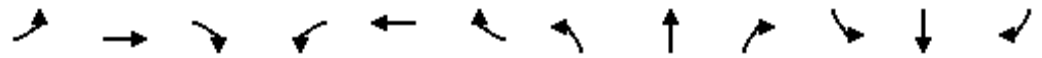

Lane Group	EBL	EBT	EBR	WBL	WBT	WBR	NBL	NBT	NBR	SBL	SBT	SBR
Lane Configurations		↕		↖	↗		↖	↗		↖	↗	
Traffic Volume (vph)	31	65	33	21	87	167	33	77	28	235	112	44
Future Volume (vph)	31	65	33	21	87	167	33	77	28	235	112	44
Ideal Flow (vphpl)	1900	1900	1900	1900	1900	1900	1900	1900	1900	1900	1900	1900
Grade (%)		-3%			3%			-2%			1%	
Storage Length (ft)	0		0	150		0	125		0	75		0
Storage Lanes	0		0	1		0	1		0	1		0
Taper Length (ft)	25			25			25			25		
Lane Util. Factor	1.00	1.00	1.00	1.00	1.00	1.00	1.00	1.00	1.00	1.00	1.00	1.00
Ped Bike Factor		0.91		0.90	0.87		0.67	0.95		0.87	0.85	
Frt		0.966			0.901			0.960			0.958	
Flt Protected		0.988		0.950			0.950			0.950		
Satd. Flow (prot)	0	1517	0	1569	1293	0	1505	1450	0	1554	1331	0
Flt Permitted		0.845		0.536			0.653			0.453		
Satd. Flow (perm)	0	1258	0	795	1293	0	698	1450	0	646	1331	0
Right Turn on Red			No			No			No			No
Satd. Flow (RTOR)												
Link Speed (mph)		25			25			25				25
Link Distance (ft)		598			651			409				995
Travel Time (s)		16.3			17.8			11.2				27.1
Confl. Peds. (#/hr)	38		43	43		38	103		33	33		103
Peak Hour Factor	0.87	0.87	0.87	0.91	0.91	0.91	0.93	0.93	0.93	0.95	0.95	0.95
Heavy Vehicles (%)	2%	2%	2%	2%	2%	2%	9%	9%	9%	4%	4%	4%
Adj. Flow (vph)	36	75	38	23	96	184	35	83	30	247	118	46
Shared Lane Traffic (%)												
Lane Group Flow (vph)	0	149	0	23	280	0	35	113	0	247	164	0
Turn Type	Perm	NA		pm+pt	NA		pm+pt	NA		pm+pt	NA	
Protected Phases		2		1	6		3	8		7	4	
Permitted Phases	2			6			8			4		
Detector Phase	2	2		1	6		3	8		7	4	
Switch Phase												
Minimum Initial (s)	10.0	10.0		7.0	10.0		7.0	7.0		7.0	7.0	
Minimum Split (s)	18.0	18.0		13.0	19.0		13.0	19.0		12.0	16.0	
Total Split (s)	50.0	50.0		20.0	70.0		20.0	35.0		20.0	35.0	
Total Split (%)	40.0%	40.0%		16.0%	56.0%		16.0%	28.0%		16.0%	28.0%	
Maximum Green (s)	43.9	43.9		14.4	64.4		14.7	29.7		15.1	29.9	
Yellow Time (s)	3.3	3.3		3.0	3.1		3.0	3.1		3.0	3.1	
All-Red Time (s)	2.8	2.8		2.6	2.5		2.3	2.2		1.9	2.0	
Lost Time Adjust (s)		-1.1		-0.6	-0.6		-0.3	-0.3		0.1	-0.1	
Total Lost Time (s)		5.0		5.0	5.0		5.0	5.0		5.0	5.0	
Lead/Lag	Lag	Lag		Lead			Lead	Lag		Lead	Lag	
Lead-Lag Optimize?	Yes	Yes		Yes			Yes	Yes		Yes	Yes	
Vehicle Extension (s)	2.0	2.0		2.0	2.0		2.0	2.0		2.0	2.0	
Recall Mode	None	None		None	None		None	None		None	None	
Walk Time (s)	4.0	4.0			4.0			4.0			4.0	
Flash Dont Walk (s)	7.0	7.0			9.0			9.0			6.0	
Pedestrian Calls (#/hr)	0	0			0			0			0	
Act Effect Green (s)		16.2		19.9	19.9		16.0	10.6		24.8	21.1	
Actuated g/C Ratio		0.29		0.36	0.36		0.29	0.19		0.44	0.38	

Lanes, Volumes, Timings

17: Raleigh Street & E. Cameron Avenue/Country Club Road

09/01/2020



Lane Group	EBL	EBT	EBR	WBL	WBT	WBR	NBL	NBT	NBR	SBL	SBT	SBR
v/c Ratio		0.41		0.06	0.61		0.11	0.41		0.49	0.33	
Control Delay		25.4		13.7	22.8		12.5	30.1		14.8	19.1	
Queue Delay		0.0		0.0	0.0		0.0	0.0		0.0	0.0	
Total Delay		25.4		13.7	22.8		12.5	30.1		14.8	19.1	
LOS		C		B	C		B	C		B	B	
Approach Delay		25.4			22.1			25.9			16.5	
Approach LOS		C			C			C			B	
Queue Length 50th (ft)		40		6	84		5	35		43	28	
Queue Length 95th (ft)		111		19	169		25	96		128	119	
Internal Link Dist (ft)		518			571			329			915	
Turn Bay Length (ft)				150			125			75		
Base Capacity (vph)		1000		546	1234		551	865		591	794	
Starvation Cap Reductn		0		0	0		0	0		0	0	
Spillback Cap Reductn		0		0	0		0	0		0	0	
Storage Cap Reductn		0		0	0		0	0		0	0	
Reduced v/c Ratio		0.15		0.04	0.23		0.06	0.13		0.42	0.21	

Intersection Summary

Area Type: CBD
 Cycle Length: 125
 Actuated Cycle Length: 56
 Natural Cycle: 65
 Control Type: Actuated-Uncoordinated
 Maximum v/c Ratio: 0.61
 Intersection Signal Delay: 20.9
 Intersection LOS: C
 Intersection Capacity Utilization 68.5%
 ICU Level of Service C
 Analysis Period (min) 15

Splits and Phases: 17: Raleigh Street & E. Cameron Avenue/Country Club Road



Lanes, Volumes, Timings
1: Church Street & W. Rosemary Street

09/01/2020



Lane Group	EBL	EBT	EBR	WBL	WBT	WBR	NBL	NBT	NBR	SBL	SBT	SBR
Lane Configurations		↕			↕			↕			↕	
Traffic Volume (vph)	24	426	66	60	441	37	47	80	64	24	76	26
Future Volume (vph)	24	426	66	60	441	37	47	80	64	24	76	26
Ideal Flow (vphpl)	1900	1900	1900	1900	1900	1900	1900	1900	1900	1900	1900	1900
Lane Width (ft)	12	14	12	12	14	12	12	12	12	12	12	12
Grade (%)		1%			-1%			0%			0%	
Lane Util. Factor	1.00	1.00	1.00	1.00	1.00	1.00	1.00	1.00	1.00	1.00	1.00	1.00
Ped Bike Factor		0.98			0.98			0.93			0.95	
Frt		0.983			0.991			0.955			0.972	
Flt Protected		0.998			0.994			0.988			0.991	
Satd. Flow (prot)	0	1710	0	0	1751	0	0	1516	0	0	1558	0
Flt Permitted		0.967			0.902			0.904			0.925	
Satd. Flow (perm)	0	1654	0	0	1582	0	0	1346	0	0	1436	0
Right Turn on Red			No			No			No			No
Satd. Flow (RTOR)												
Link Speed (mph)		20			20			25			25	
Link Distance (ft)		964			757			379			430	
Travel Time (s)		32.9			25.8			10.3			11.7	
Confl. Peds. (#/hr)	40		37	37		40	62		43	43		62
Peak Hour Factor	0.95	0.95	0.95	0.97	0.97	0.97	0.91	0.91	0.91	0.93	0.93	0.93
Adj. Flow (vph)	25	448	69	62	455	38	52	88	70	26	82	28
Shared Lane Traffic (%)												
Lane Group Flow (vph)	0	542	0	0	555	0	0	210	0	0	136	0
Turn Type	Perm	NA		Perm	NA		Perm	NA		Perm	NA	
Protected Phases		2			6			8			4	
Permitted Phases	2			6			8			4		
Detector Phase	2	2		6	6		8	8		4	4	
Switch Phase												
Minimum Initial (s)	10.0	10.0		10.0	10.0		7.0	7.0		7.0	7.0	
Minimum Split (s)	19.0	19.0		20.0	20.0		19.0	19.0		19.0	19.0	
Total Split (s)	45.0	45.0		45.0	45.0		25.0	25.0		25.0	25.0	
Total Split (%)	64.3%	64.3%		64.3%	64.3%		35.7%	35.7%		35.7%	35.7%	
Maximum Green (s)	40.5	40.5		40.4	40.4		20.1	20.1		20.1	20.1	
Yellow Time (s)	3.1	3.1		3.1	3.1		3.2	3.2		3.2	3.2	
All-Red Time (s)	1.4	1.4		1.5	1.5		1.7	1.7		1.7	1.7	
Lost Time Adjust (s)		0.5			0.4			0.1			0.1	
Total Lost Time (s)		5.0			5.0			5.0			5.0	
Lead/Lag												
Lead-Lag Optimize?												
Vehicle Extension (s)	3.0	3.0		3.0	3.0		3.0	3.0		3.0	3.0	
Recall Mode	C-Max	C-Max		C-Max	C-Max		None	None		None	None	
Walk Time (s)	4.0	4.0		4.0	4.0		4.0	4.0		4.0	4.0	
Flash Dont Walk (s)	5.0	5.0		6.0	6.0		10.0	10.0		10.0	10.0	
Pedestrian Calls (#/hr)	0	0		0	0		0	0		0	0	
Act Effct Green (s)		44.5			44.5			15.5			15.5	
Actuated g/C Ratio		0.64			0.64			0.22			0.22	
v/c Ratio		0.52			0.55			0.71			0.43	
Control Delay		10.1			5.4			36.9			26.6	
Queue Delay		0.0			0.0			0.0			0.0	

Lanes, Volumes, Timings
 1: Church Street & W. Rosemary Street

09/01/2020



Lane Group	EBL	EBT	EBR	WBL	WBT	WBR	NBL	NBT	NBR	SBL	SBT	SBR
Total Delay		10.1			5.4			36.9			26.6	
LOS		B			A			D			C	
Approach Delay		10.1			5.4			36.9			26.6	
Approach LOS		B			A			D			C	
Queue Length 50th (ft)		113			70			75			50	
Queue Length 95th (ft)		221			m103			m94			91	
Internal Link Dist (ft)		884			677			299			350	
Turn Bay Length (ft)												
Base Capacity (vph)		1051			1006			384			410	
Starvation Cap Reductn		0			0			0			0	
Spillback Cap Reductn		0			0			0			0	
Storage Cap Reductn		0			0			0			0	
Reduced v/c Ratio		0.52			0.55			0.55			0.33	

Intersection Summary

Area Type: CBD
 Cycle Length: 70
 Actuated Cycle Length: 70
 Offset: 25 (36%), Referenced to phase 2:EBTL and 6:WBTL, Start of Green
 Natural Cycle: 55
 Control Type: Actuated-Coordinated
 Maximum v/c Ratio: 0.71
 Intersection Signal Delay: 13.8
 Intersection LOS: B
 Intersection Capacity Utilization 80.7%
 ICU Level of Service D
 Analysis Period (min) 15
 m Volume for 95th percentile queue is metered by upstream signal.

Splits and Phases: 1: Church Street & W. Rosemary Street



Lanes, Volumes, Timings

2: NC 86 (N. Columbia St) & W. Rosemary Street/E. Rosemary Street

09/01/2020



Lane Group	EBL	EBT	EBR	WBL	WBT	WBR	NBL	NBT	NBR	SBL	SBT	SBR
Lane Configurations												
Traffic Volume (vph)	232	272	49	91	227	37	52	597	90	62	515	277
Future Volume (vph)	232	272	49	91	227	37	52	597	90	62	515	277
Ideal Flow (vphpl)	1900	1900	1900	1900	1900	1900	1900	1900	1900	1900	1900	1900
Lane Width (ft)	9	12	13	12	12	12	9	10	12	12	9	11
Grade (%)		1%			1%			-2%				8%
Storage Length (ft)	100		0	150		0	75		0	150		400
Storage Lanes	1		0	1		0	1		0	1		1
Taper Length (ft)	25			25			25			25		
Lane Util. Factor	1.00	1.00	1.00	1.00	1.00	1.00	1.00	0.95	0.95	1.00	0.95	1.00
Ped Bike Factor	0.97	0.99		0.96	0.99		0.94	0.95				0.73
Frt		0.977			0.979			0.980				0.850
Flt Protected	0.950			0.950			0.950			0.950		
Satd. Flow (prot)	1426	1612	0	1585	1613	0	1420	2752	0	1514	2725	1310
Flt Permitted	0.187			0.544			0.351			0.244		
Satd. Flow (perm)	272	1612	0	874	1613	0	491	2752	0	389	2725	952
Right Turn on Red			No			No			No			No
Satd. Flow (RTOR)												
Link Speed (mph)		20			20			25			25	
Link Distance (ft)		757			461			353			476	
Travel Time (s)		25.8			15.7			9.6			13.0	
Confl. Peds. (#/hr)	49		36	36		49	59		83	83		59
Peak Hour Factor	0.88	0.88	0.88	0.94	0.94	0.94	0.83	0.83	0.83	0.82	0.82	0.82
Heavy Vehicles (%)	2%	2%	2%	2%	2%	2%	4%	4%	4%	3%	3%	3%
Adj. Flow (vph)	264	309	56	97	241	39	63	719	108	76	628	338
Shared Lane Traffic (%)												
Lane Group Flow (vph)	264	365	0	97	280	0	63	827	0	76	628	338
Turn Type	pm+pt	NA		Perm	NA		pm+pt	NA		pm+pt	NA	pm+ov
Protected Phases	7	4			8		5	2		1	6	7
Permitted Phases	4			8			2			6		6
Detector Phase	7	4		8	8		5	2		1	6	7
Switch Phase												
Minimum Initial (s)	7.0	7.0		7.0	7.0		7.0	10.0		7.0	10.0	7.0
Minimum Split (s)	13.0	31.0		32.0	32.0		13.0	23.0		13.0	22.0	13.0
Total Split (s)	24.0	56.0		32.0	32.0		20.0	64.0		20.0	64.0	24.0
Total Split (%)	17.1%	40.0%		22.9%	22.9%		14.3%	45.7%		14.3%	45.7%	17.1%
Maximum Green (s)	18.2	50.0		26.0	26.0		14.2	58.2		14.9	58.2	18.2
Yellow Time (s)	3.0	3.2		3.2	3.2		3.0	3.3		3.0	3.3	3.0
All-Red Time (s)	2.8	2.8		2.8	2.8		2.8	2.5		2.1	2.5	2.8
Lost Time Adjust (s)	-0.8	-1.0		-1.0	-1.0		-1.0	-0.8		-0.1	-0.8	-0.8
Total Lost Time (s)	5.0	5.0		5.0	5.0		4.8	5.0		5.0	5.0	5.0
Lead/Lag	Lead			Lag	Lag		Lead	Lag		Lead	Lag	Lead
Lead-Lag Optimize?												
Vehicle Extension (s)	1.0	1.0		1.0	1.0		1.0	3.0		1.0	3.0	1.0
Recall Mode	None	None		None	None		None	C-Max		None	C-Max	None
Walk Time (s)		7.0		7.0	7.0			7.0			7.0	
Flash Dont Walk (s)		18.0		19.0	19.0			10.0			9.0	
Pedestrian Calls (#/hr)		0		0	0			0			0	
Act Effect Green (s)	50.0	50.0		26.0	26.0		75.9	67.3		75.6	69.4	88.4

Lanes, Volumes, Timings

2: NC 86 (N. Columbia St) & W. Rosemary Street/E. Rosemary Street

09/01/2020



Lane Group	EBL	EBT	EBR	WBL	WBT	WBR	NBL	NBT	NBR	SBL	SBT	SBR
Actuated g/C Ratio	0.36	0.36		0.19	0.19		0.54	0.48		0.54	0.50	0.63
v/c Ratio	1.04	0.63		0.60	0.94		0.20	0.63		0.28	0.47	0.52
Control Delay	104.1	44.8		66.5	90.9		5.6	7.6		12.2	15.1	8.3
Queue Delay	0.0	0.0		0.0	0.0		0.0	2.7		0.0	0.2	0.0
Total Delay	104.1	44.8		66.5	90.9		5.6	10.3		12.2	15.2	8.3
LOS	F	D		E	F		A	B		B	B	A
Approach Delay		69.7			84.6			10.0			12.8	
Approach LOS		E			F			A			B	
Queue Length 50th (ft)	~213	294		79	236		7	51		17	112	48
Queue Length 95th (ft)	#362	404		148	#418		m7	m52		m28	105	45
Internal Link Dist (ft)		677			381			273			396	
Turn Bay Length (ft)	100			150			75			150		400
Base Capacity (vph)	253	587		168	311		382	1323		343	1349	649
Starvation Cap Reductn	0	0		0	0		0	364		0	167	0
Spillback Cap Reductn	0	0		0	0		0	0		0	94	0
Storage Cap Reductn	0	0		0	0		0	0		0	0	0
Reduced v/c Ratio	1.04	0.62		0.58	0.90		0.16	0.86		0.22	0.53	0.52

Intersection Summary

Area Type:	CBD
Cycle Length:	140
Actuated Cycle Length:	140
Offset:	62 (44%), Referenced to phase 2:NBTL and 6:SBTL, Start of Green
Natural Cycle:	85
Control Type:	Actuated-Coordinated
Maximum v/c Ratio:	1.04
Intersection Signal Delay:	33.3
Intersection LOS:	C
Intersection Capacity Utilization:	79.6%
ICU Level of Service:	D
Analysis Period (min):	15
~	Volume exceeds capacity, queue is theoretically infinite. Queue shown is maximum after two cycles.
#	95th percentile volume exceeds capacity, queue may be longer. Queue shown is maximum after two cycles.
m	Volume for 95th percentile queue is metered by upstream signal.

Splits and Phases: 2: NC 86 (N. Columbia St) & W. Rosemary Street/E. Rosemary Street

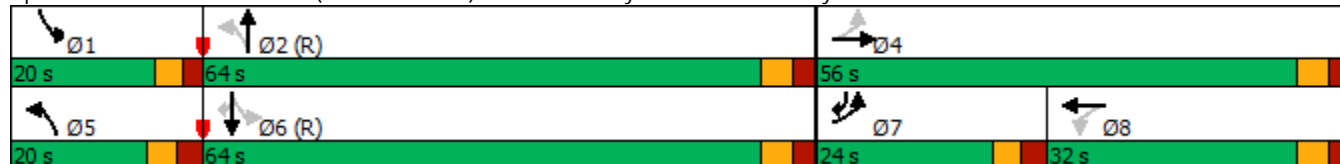

Lanes, Volumes, Timings
6: Henderson Street & E. Rosemary Street

09/01/2020



Lane Group	EBL	EBT	EBR	WBL	WBT	WBR	NBL	NBT	NBR	SBL	SBT	SBR
Lane Configurations												
Traffic Volume (vph)	43	273	139	12	196	58	64	24	5	23	57	10
Future Volume (vph)	43	273	139	12	196	58	64	24	5	23	57	10
Ideal Flow (vphpl)	1900	1900	1900	1900	1900	1900	1900	1900	1900	1900	1900	1900
Grade (%)		0%			0%			0%				3%
Storage Length (ft)	85		0	0		0	0		0	0		0
Storage Lanes	1		0	0		0	0		0	0		0
Taper Length (ft)	25			25			25			25		
Lane Util. Factor	1.00	1.00	1.00	1.00	1.00	1.00	1.00	1.00	1.00	1.00	1.00	1.00
Ped Bike Factor	0.98	0.96			0.98			0.88				0.95
Frt		0.949			0.971			0.993				0.985
Flt Protected	0.950				0.998			0.967				0.987
Satd. Flow (prot)	1593	1523	0	0	1602	0	0	1597	0	0	1566	0
Flt Permitted	0.617				0.979			0.759				0.909
Satd. Flow (perm)	1012	1523	0	0	1569	0	0	1108	0	0	1402	0
Right Turn on Red			No			No			No			No
Satd. Flow (RTOR)												
Link Speed (mph)		20			20			20				20
Link Distance (ft)		496			1195			366				450
Travel Time (s)		16.9			40.7			12.5				15.3
Confl. Peds. (#/hr)	14		34	34		14	73		51	51		73
Peak Hour Factor	0.90	0.90	0.90	0.93	0.93	0.93	0.67	0.67	0.67	0.79	0.79	0.79
Adj. Flow (vph)	48	303	154	13	211	62	96	36	7	29	72	13
Shared Lane Traffic (%)												
Lane Group Flow (vph)	48	457	0	0	286	0	0	139	0	0	114	0
Turn Type	Perm	NA		Perm	NA		Perm	NA		Perm	NA	
Protected Phases		2			2			4				4
Permitted Phases	2			2			4			4		
Detector Phase	2	2		2	2		4	4		4		4
Switch Phase												
Minimum Initial (s)	11.0	11.0		11.0	11.0		8.0	8.0		8.0		8.0
Minimum Split (s)	15.9	15.9		15.9	15.9		17.8	17.8		17.8		17.8
Total Split (s)	32.0	32.0		32.0	32.0		38.0	38.0		38.0		38.0
Total Split (%)	45.7%	45.7%		45.7%	45.7%		54.3%	54.3%		54.3%		54.3%
Maximum Green (s)	27.1	27.1		27.1	27.1		33.2	33.2		33.2		33.2
Yellow Time (s)	3.3	3.3		3.3	3.3		3.3	3.3		3.3		3.3
All-Red Time (s)	1.6	1.6		1.6	1.6		1.5	1.5		1.5		1.5
Lost Time Adjust (s)	0.1	0.0			0.1			0.2				0.2
Total Lost Time (s)	5.0	4.9			5.0			5.0				5.0
Lead/Lag												
Lead-Lag Optimize?												
Vehicle Extension (s)	2.0	2.0		2.0	2.0		2.0	2.0		2.0		2.0
Recall Mode	C-Max	C-Max		C-Max	C-Max		None	None		None		None
Walk Time (s)	4.0	4.0		4.0	4.0		4.0	4.0		4.0		4.0
Flash Dont Walk (s)	7.0	7.0		7.0	7.0		9.0	9.0		9.0		9.0
Pedestrian Calls (#/hr)	0	0		0	0		0	0		0		0
Act Effct Green (s)	46.4	46.5			46.4			13.6				13.6
Actuated g/C Ratio	0.66	0.66			0.66			0.19				0.19
v/c Ratio	0.07	0.45			0.28			0.65				0.42

Lanes, Volumes, Timings
 6: Henderson Street & E. Rosemary Street

09/01/2020



Lane Group	EBL	EBT	EBR	WBL	WBT	WBR	NBL	NBT	NBR	SBL	SBT	SBR
Control Delay	6.8	8.2			5.7			30.2			27.9	
Queue Delay	0.0	0.0			0.0			0.0			0.0	
Total Delay	6.8	8.2			5.7			30.2			27.9	
LOS	A	A			A			C			C	
Approach Delay		8.1			5.7			30.2			27.9	
Approach LOS		A			A			C			C	
Queue Length 50th (ft)	6	75			57			53			44	
Queue Length 95th (ft)	m22	181			108			41			66	
Internal Link Dist (ft)		416			1115			286			370	
Turn Bay Length (ft)	85											
Base Capacity (vph)	670	1011			1039			522			660	
Starvation Cap Reductn	0	0			0			0			0	
Spillback Cap Reductn	0	0			0			0			0	
Storage Cap Reductn	0	0			0			0			0	
Reduced v/c Ratio	0.07	0.45			0.28			0.27			0.17	

Intersection Summary

Area Type: CBD
 Cycle Length: 70
 Actuated Cycle Length: 70
 Offset: 14 (20%), Referenced to phase 2:EBWB, Start of Green
 Natural Cycle: 45
 Control Type: Actuated-Coordinated
 Maximum v/c Ratio: 0.65
 Intersection Signal Delay: 12.5
 Intersection LOS: B
 Intersection Capacity Utilization 47.8%
 ICU Level of Service A
 Analysis Period (min) 15
 m Volume for 95th percentile queue is metered by upstream signal.

Splits and Phases: 6: Henderson Street & E. Rosemary Street

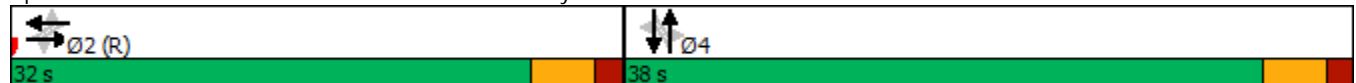

Lanes, Volumes, Timings
 7: Hillsborough Street & E. Rosemary Street

09/01/2020



Lane Group	EBL	EBT	EBR	WBL	WBT	WBR	NBL	NBT	NBR	SBL	SBT	SBR
Lane Configurations		↕			↕		↗	↘		↗	↘	
Traffic Volume (vph)	39	136	63	10	100	57	164	298	23	37	205	27
Future Volume (vph)	39	136	63	10	100	57	164	298	23	37	205	27
Ideal Flow (vphpl)	1900	1900	1900	1900	1900	1900	1900	1900	1900	1900	1900	1900
Storage Length (ft)	0		0	0		0	100		0	100		0
Storage Lanes	0		0	0		0	1		0	1		0
Taper Length (ft)	25			25			25			25		
Lane Util. Factor	1.00	1.00	1.00	1.00	1.00	1.00	1.00	1.00	1.00	1.00	1.00	1.00
Ped Bike Factor		0.98			0.97		0.92	1.00		0.98	0.98	
Frt		0.964			0.954			0.989			0.983	
Flt Protected		0.992			0.997		0.950			0.950		
Satd. Flow (prot)	0	1757	0	0	1713	0	1770	1836	0	1770	1789	0
Flt Permitted		0.909			0.976		0.504			0.552		
Satd. Flow (perm)	0	1597	0	0	1675	0	863	1836	0	1008	1789	0
Right Turn on Red			No			No			No			No
Satd. Flow (RTOR)												
Link Speed (mph)		20			20			25			25	
Link Distance (ft)		1195			527			363			726	
Travel Time (s)		40.7			18.0			9.9			19.8	
Confl. Peds. (#/hr)	27		14	14		27	52		9	9		52
Peak Hour Factor	0.86	0.86	0.86	0.79	0.79	0.79	0.92	0.92	0.92	0.96	0.96	0.96
Adj. Flow (vph)	45	158	73	13	127	72	178	324	25	39	214	28
Shared Lane Traffic (%)												
Lane Group Flow (vph)	0	276	0	0	212	0	178	349	0	39	242	0
Turn Type	Perm	NA		Perm	NA		pm+pt	NA		Perm	NA	
Protected Phases		4			8		5	2			6	
Permitted Phases	4			8			2			6		
Detector Phase	4	4		8	8		5	2		6	6	
Switch Phase												
Minimum Initial (s)	7.0	7.0		7.0	7.0		7.0	10.0		10.0	10.0	
Minimum Split (s)	20.0	20.0		17.0	17.0		12.0	15.0		15.0	15.0	
Total Split (s)	30.0	30.0		30.0	30.0		14.0	40.0		26.0	26.0	
Total Split (%)	42.9%	42.9%		42.9%	42.9%		20.0%	57.1%		37.1%	37.1%	
Maximum Green (s)	25.1	25.1		25.0	25.0		9.2	35.2		21.2	21.2	
Yellow Time (s)	3.0	3.0		3.3	3.3		3.0	3.3		3.1	3.1	
All-Red Time (s)	1.9	1.9		1.7	1.7		1.8	1.5		1.7	1.7	
Lost Time Adjust (s)		0.1			0.0		0.2	0.2		0.2	0.2	
Total Lost Time (s)		5.0			5.0		5.0	5.0		5.0	5.0	
Lead/Lag							Lead			Lag	Lag	
Lead-Lag Optimize?												
Vehicle Extension (s)	2.0	2.0		2.0	2.0		2.0	2.0		2.0	2.0	
Recall Mode	None	None		None	None		None	C-Max		C-Max	C-Max	
Walk Time (s)	4.0	4.0		4.0	4.0			4.0		4.0	4.0	
Flash Dont Walk (s)	11.0	11.0		8.0	8.0			6.0		6.0	6.0	
Pedestrian Calls (#/hr)	0	0		0	0			0		0	0	
Act Effct Green (s)		16.2			16.2		43.8	43.8		30.7	30.7	
Actuated g/C Ratio		0.23			0.23		0.63	0.63		0.44	0.44	
v/c Ratio		0.75			0.55		0.28	0.30		0.09	0.31	
Control Delay		32.6			28.0		6.3	6.6		15.5	16.3	

Lanes, Volumes, Timings
 7: Hillsborough Street & E. Rosemary Street

09/01/2020



Lane Group	EBL	EBT	EBR	WBL	WBT	WBR	NBL	NBT	NBR	SBL	SBT	SBR
Queue Delay		0.0			0.0		0.0	0.3		0.0	0.0	
Total Delay		32.6			28.0		6.3	6.9		15.5	16.3	
LOS		C			C		A	A		B	B	
Approach Delay		32.6			28.0			6.7			16.2	
Approach LOS		C			C			A			B	
Queue Length 50th (ft)		111			80		32	80		9	63	
Queue Length 95th (ft)		136			106		64	142		34	145	
Internal Link Dist (ft)		1115			447			283			646	
Turn Bay Length (ft)							100			100		
Base Capacity (vph)		570			598		661	1147		442	784	
Starvation Cap Reductn		0			0		0	346		0	0	
Spillback Cap Reductn		0			0		0	0		0	0	
Storage Cap Reductn		0			0		0	0		0	0	
Reduced v/c Ratio		0.48			0.35		0.27	0.44		0.09	0.31	

Intersection Summary

Area Type:	Other
Cycle Length:	70
Actuated Cycle Length:	70
Offset:	32 (46%), Referenced to phase 2:NBTL and 6:SBTL, Start of Green
Natural Cycle:	50
Control Type:	Actuated-Coordinated
Maximum v/c Ratio:	0.75
Intersection Signal Delay:	17.8
Intersection LOS:	B
Intersection Capacity Utilization	63.0%
ICU Level of Service	B
Analysis Period (min)	15

Splits and Phases: 7: Hillsborough Street & E. Rosemary Street



Lanes, Volumes, Timings

8: Carolina Square Driveway/Church Street & W. Franklin Street

09/01/2020



Lane Group	EBL	EBT	EBR	WBL	WBT	WBR	NBL	NBT	NBR	SBL	SBT	SBR
Lane Configurations												
Traffic Volume (vph)	66	467	18	41	572	73	24	48	40	74	60	76
Future Volume (vph)	66	467	18	41	572	73	24	48	40	74	60	76
Ideal Flow (vphpl)	1900	1900	1900	1900	1900	1900	1900	1900	1900	1900	1900	1900
Lane Width (ft)	10	10	16	10	10	10	12	12	12	12	12	12
Grade (%)		2%			-2%			-4%				-3%
Storage Length (ft)	150		0	200		0	0		100	0		0
Storage Lanes	1		0	1		0	0		1	0		0
Taper Length (ft)	25			25			25			25		
Lane Util. Factor	1.00	1.00	1.00	1.00	1.00	1.00	1.00	1.00	1.00	1.00	1.00	1.00
Ped Bike Factor		0.99		0.88	0.96			0.94	0.88		0.86	
Frt		0.994			0.983				0.850		0.951	
Flt Protected	0.950			0.950				0.983			0.983	
Satd. Flow (prot)	1457	1504	0	1501	1493	0	0	1681	1454	0	1414	0
Flt Permitted	0.280			0.389				0.865			0.852	
Satd. Flow (perm)	430	1504	0	540	1493	0	0	1386	1282	0	1187	0
Right Turn on Red			No			No			No			No
Satd. Flow (RTOR)												
Link Speed (mph)		20			20			20			25	
Link Distance (ft)		993			294			285			379	
Travel Time (s)		33.9			10.0			9.7			10.3	
Confl. Peds. (#/hr)	124		164	164		124	175		63	63		175
Peak Hour Factor	0.91	0.91	0.91	0.93	0.93	0.93	0.81	0.81	0.81	0.91	0.91	0.91
Heavy Vehicles (%)	3%	3%	3%	2%	2%	2%	2%	2%	2%	2%	2%	2%
Adj. Flow (vph)	73	513	20	44	615	78	30	59	49	81	66	84
Shared Lane Traffic (%)												
Lane Group Flow (vph)	73	533	0	44	693	0	0	89	49	0	231	0
Turn Type	Perm	NA		Perm	NA		Perm	NA	Perm	Perm	NA	
Protected Phases		2			6			8				4
Permitted Phases	2			6			8		8	4		
Detector Phase	2	2		6	6		8	8	8	4	4	
Switch Phase												
Minimum Initial (s)	10.0	10.0		10.0	10.0		7.0	7.0	7.0	7.0	7.0	
Minimum Split (s)	22.0	22.0		19.0	19.0		29.0	29.0	29.0	27.0	27.0	
Total Split (s)	41.0	41.0		41.0	41.0		29.0	29.0	29.0	29.0	29.0	
Total Split (%)	58.6%	58.6%		58.6%	58.6%		41.4%	41.4%	41.4%	41.4%	41.4%	
Maximum Green (s)	35.4	35.4		35.4	35.4		22.7	22.7	22.7	23.0	23.0	
Yellow Time (s)	3.3	3.3		3.3	3.3		3.1	3.1	3.1	3.4	3.4	
All-Red Time (s)	2.3	2.3		2.3	2.3		3.2	3.2	3.2	2.6	2.6	
Lost Time Adjust (s)	-0.6	-0.6		-0.6	-0.6		-1.3	-1.3	-1.3		-1.0	
Total Lost Time (s)	5.0	5.0		5.0	5.0		5.0	5.0	5.0		5.0	
Lead/Lag												
Lead-Lag Optimize?												
Vehicle Extension (s)	3.0	3.0		3.0	3.0		2.0	2.0	2.0	2.0	2.0	
Recall Mode	C-Max	C-Max		C-Max	C-Max		None	None	None	None	None	
Walk Time (s)	7.0	7.0		7.0	7.0		7.0	7.0	7.0	7.0	7.0	
Flash Dont Walk (s)	9.0	9.0		6.0	6.0		15.0	15.0	15.0	14.0	14.0	
Pedestrian Calls (#/hr)	0	0		0	0		0	0	0	0	0	
Act Effect Green (s)	41.8	41.8		41.8	41.8		18.2	18.2	18.2		18.2	

Lanes, Volumes, Timings

8: Carolina Square Driveway/Church Street & W. Franklin Street

09/01/2020



Lane Group	EBL	EBT	EBR	WBL	WBT	WBR	NBL	NBT	NBR	SBL	SBT	SBR
Actuated g/C Ratio	0.60	0.60		0.60	0.60			0.26	0.26		0.26	
v/c Ratio	0.29	0.59		0.14	0.78			0.25	0.15		0.75	
Control Delay	12.7	13.8		10.0	17.9			20.2	18.7		36.2	
Queue Delay	0.0	0.0		0.0	0.0			0.0	0.0		0.0	
Total Delay	12.7	13.8		10.0	17.9			20.2	18.7		36.2	
LOS	B	B		B	B			C	B		D	
Approach Delay		13.7			17.5			19.7			36.2	
Approach LOS		B			B			B			D	
Queue Length 50th (ft)	14	132		15	330			30	16		99	
Queue Length 95th (ft)	48	273		m18	m326			51	32		115	
Internal Link Dist (ft)		913			214			205			299	
Turn Bay Length (ft)	150			200					100			
Base Capacity (vph)	256	897		322	890			475	439		406	
Starvation Cap Reductn	0	0		0	0			0	0		0	
Spillback Cap Reductn	0	0		0	0			0	0		0	
Storage Cap Reductn	0	0		0	0			0	0		0	
Reduced v/c Ratio	0.29	0.59		0.14	0.78			0.19	0.11		0.57	

Intersection Summary

Area Type:	CBD
Cycle Length:	70
Actuated Cycle Length:	70
Offset:	66 (94%), Referenced to phase 2:EBTL and 6:WBTL, Start of Green
Natural Cycle:	70
Control Type:	Actuated-Coordinated
Maximum v/c Ratio:	0.78
Intersection Signal Delay:	18.8
Intersection LOS:	B
Intersection Capacity Utilization:	82.5%
ICU Level of Service:	E
Analysis Period (min):	15
m Volume for 95th percentile queue is metered by upstream signal.	

Splits and Phases: 8: Carolina Square Driveway/Church Street & W. Franklin Street

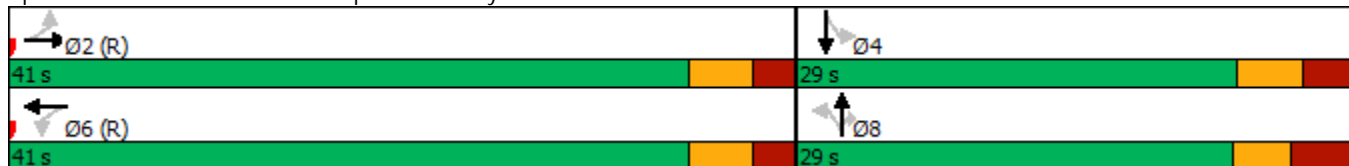

Lanes, Volumes, Timings

9: NC 86 (S. Columbia St)/NC 86 (N. Columbia St) & W. Franklin Street/E. Franklin Street 09/01/2020



Lane Group	EBL	EBT	EBR	WBL	WBT	WBR	NBL	NBT	NBR	SBL	SBT	SBR
Lane Configurations												
Traffic Volume (vph)	179	434	76	102	519	67	65	567	113	74	421	121
Future Volume (vph)	179	434	76	102	519	67	65	567	113	74	421	121
Ideal Flow (vphpl)	1900	1900	1900	1900	1900	1900	1900	1900	1900	1900	1900	1900
Lane Width (ft)	9	12	13	10	10	13	9	10	10	9	9	11
Grade (%)		3%			1%			-2%			3%	
Storage Length (ft)	250		0	125		0	475		0	125		0
Storage Lanes	1		0	1		1	1		0	1		0
Taper Length (ft)	25			25			25			25		
Lane Util. Factor	1.00	0.95	0.95	1.00	1.00	1.00	1.00	0.95	0.95	1.00	0.95	0.95
Ped Bike Factor	0.87	0.96		0.87		0.68	0.90	0.96		0.93	0.95	
Frt		0.978				0.850		0.975			0.966	
Flt Protected	0.950			0.950			0.950			0.950		
Satd. Flow (prot)	1412	2933	0	1479	1557	1465	1380	2691	0	1385	2538	0
Flt Permitted	0.950			0.950			0.950			0.950		
Satd. Flow (perm)	1224	2933	0	1289	1557	997	1248	2691	0	1285	2538	0
Right Turn on Red			No			No			No			No
Satd. Flow (RTOR)												
Link Speed (mph)		20			20			25			25	
Link Distance (ft)		461			941			981			353	
Travel Time (s)		15.7			32.1			26.8			9.6	
Confl. Peds. (#/hr)	193		152	152		193	67		108	108		67
Peak Hour Factor	0.87	0.87	0.87	0.84	0.84	0.84	0.90	0.90	0.90	0.94	0.94	0.94
Heavy Vehicles (%)	2%	2%	2%	2%	2%	2%	7%	7%	7%	4%	4%	4%
Adj. Flow (vph)	206	499	87	121	618	80	72	630	126	79	448	129
Shared Lane Traffic (%)												
Lane Group Flow (vph)	206	586	0	121	618	80	72	756	0	79	577	0
Turn Type	Prot	NA		Prot	NA	pm+ov	Prot	NA		Prot	NA	
Protected Phases	5	2		1	6	7	3	8		7	4	
Permitted Phases						6						
Detector Phase	5	2		1	6	7	3	8		7	4	
Switch Phase												
Minimum Initial (s)	7.0	10.0		7.0	10.0	7.0	7.0	7.0		7.0	7.0	
Minimum Split (s)	15.0	28.2		15.0	28.2	15.0	15.0	28.0		15.0	28.1	
Total Split (s)	22.0	36.0		43.0	57.0	15.0	21.0	46.0		15.0	40.0	
Total Split (%)	15.7%	25.7%		30.7%	40.7%	10.7%	15.0%	32.9%		10.7%	28.6%	
Maximum Green (s)	16.6	29.8		37.1	50.8	9.1	15.1	40.1		9.1	34.3	
Yellow Time (s)	3.0	3.0		3.0	3.0	3.0	3.0	3.3		3.0	3.1	
All-Red Time (s)	2.4	3.2		2.9	3.2	2.9	2.9	2.6		2.9	2.6	
Lost Time Adjust (s)	-0.4	-1.2		-0.9	-1.2	-2.0	-0.9	-0.9		-0.9	-0.7	
Total Lost Time (s)	5.0	5.0		5.0	5.0	3.9	5.0	5.0		5.0	5.0	
Lead/Lag	Lead	Lag		Lead	Lag	Lead	Lead	Lag		Lead	Lag	
Lead-Lag Optimize?	Yes	Yes		Yes	Yes	Yes	Yes	Yes		Yes	Yes	
Vehicle Extension (s)	1.0	3.0		1.0	3.0	1.0	1.0	2.0		1.0	2.0	
Recall Mode	None	C-Max		None	C-Max	None	None	Ped		None	Ped	
Walk Time (s)		7.0			7.0			7.0			7.0	
Flash Dont Walk (s)		15.0			15.0			15.0			15.0	
Pedestrian Calls (#/hr)		0			0			0			0	
Act Effect Green (s)	17.8	53.9		15.9	52.0	63.8	11.7	40.6		9.6	41.0	

Lanes, Volumes, Timings

9: NC 86 (S. Columbia St)/NC 86 (N. Columbia St) & W. Franklin Street/E. Franklin Street 09/01/2020



Lane Group	EBL	EBT	EBR	WBL	WBT	WBR	NBL	NBT	NBR	SBL	SBT	SBR
Actuated g/C Ratio	0.13	0.38		0.11	0.37	0.46	0.08	0.29		0.07	0.29	
v/c Ratio	1.15	0.52		0.72	1.07	0.16	0.63	0.97		0.84	0.78	
Control Delay	161.0	36.5		93.9	92.0	21.6	100.2	24.2		127.0	46.7	
Queue Delay	0.0	0.0		0.0	0.0	0.0	0.0	0.0		0.0	0.9	
Total Delay	161.0	36.5		93.9	92.0	21.6	100.2	24.2		127.0	47.5	
LOS	F	D		F	F	C	F	C		F	D	
Approach Delay		68.9			85.4			30.8			57.1	
Approach LOS		E			F			C			E	
Queue Length 50th (ft)	~230	202		113	-640	31	64	215		76	151	
Queue Length 95th (ft)	#374	301		169	#784	55	m60	m161		m#168	#368	
Internal Link Dist (ft)		381			861			901			273	
Turn Bay Length (ft)	250			125			475			125		
Base Capacity (vph)	179	1129		401	578	494	157	788		98	743	
Starvation Cap Reductn	0	0		0	0	0	0	0		0	38	
Spillback Cap Reductn	0	0		0	0	0	0	0		0	0	
Storage Cap Reductn	0	0		0	0	0	0	0		0	0	
Reduced v/c Ratio	1.15	0.52		0.30	1.07	0.16	0.46	0.96		0.81	0.82	

Intersection Summary

Area Type: CBD
 Cycle Length: 140
 Actuated Cycle Length: 140
 Offset: 0 (0%), Referenced to phase 2:EBT and 6:WBT, Start of Green
 Natural Cycle: 150
 Control Type: Actuated-Coordinated
 Maximum v/c Ratio: 1.15
 Intersection Signal Delay: 60.6 Intersection LOS: E
 Intersection Capacity Utilization 86.3% ICU Level of Service E
 Analysis Period (min) 15
 ~ Volume exceeds capacity, queue is theoretically infinite.
 Queue shown is maximum after two cycles.
 # 95th percentile volume exceeds capacity, queue may be longer.
 Queue shown is maximum after two cycles.
 m Volume for 95th percentile queue is metered by upstream signal.

Splits and Phases: 9: NC 86 (S. Columbia St)/NC 86 (N. Columbia St) & W. Franklin Street/E. Franklin Street



Lanes, Volumes, Timings
 10: E. Franklin Street & Henderson Street

09/01/2020



Lane Group	EBL	EBT	WBT	WBR	SBL	SBR
Lane Configurations		↕↕	↕↔		↔↔	
Traffic Volume (vph)	34	607	654	68	152	58
Future Volume (vph)	34	607	654	68	152	58
Ideal Flow (vphpl)	1900	1900	1900	1900	1900	1900
Lane Width (ft)	10	13	10	10	11	11
Grade (%)		-2%	2%		3%	
Lane Util. Factor	0.95	0.95	0.95	0.95	1.00	1.00
Ped Bike Factor		1.00	0.97		0.87	
Frt			0.986		0.963	
Flt Protected		0.997			0.965	
Satd. Flow (prot)	0	3282	2825	0	1390	0
Flt Permitted		0.885			0.965	
Satd. Flow (perm)	0	2902	2825	0	1293	0
Right Turn on Red				No		No
Satd. Flow (RTOR)						
Link Speed (mph)		20	20		20	
Link Distance (ft)		941	1200		366	
Travel Time (s)		32.1	40.9		12.5	
Confl. Peds. (#/hr)	114			114	88	198
Peak Hour Factor	0.90	0.90	0.93	0.93	0.83	0.83
Heavy Vehicles (%)	3%	3%	2%	2%	2%	2%
Parking (#/hr)						0
Adj. Flow (vph)	38	674	703	73	183	70
Shared Lane Traffic (%)						
Lane Group Flow (vph)	0	712	776	0	253	0
Turn Type	Perm	NA	NA		Prot	
Protected Phases		2	6		4	
Permitted Phases	2					
Detector Phase	2	2	6		4	
Switch Phase						
Minimum Initial (s)	10.0	10.0	10.0		7.0	
Minimum Split (s)	16.2	16.2	21.1		24.1	
Total Split (s)	43.0	43.0	43.0		27.0	
Total Split (%)	61.4%	61.4%	61.4%		38.6%	
Maximum Green (s)	36.8	36.8	36.9		21.9	
Yellow Time (s)	3.0	3.0	3.0		3.0	
All-Red Time (s)	3.2	3.2	3.1		2.1	
Lost Time Adjust (s)		-1.2	-1.1		-0.1	
Total Lost Time (s)		5.0	5.0		5.0	
Lead/Lag						
Lead-Lag Optimize?						
Vehicle Extension (s)	2.0	2.0	2.0		1.0	
Recall Mode	C-Max	C-Max	C-Max		None	
Walk Time (s)			7.0		7.0	
Flash Dont Walk (s)			8.0		12.0	
Pedestrian Calls (#/hr)			0		0	
Act Effct Green (s)		44.0	44.0		16.0	
Actuated g/C Ratio		0.63	0.63		0.23	
v/c Ratio		0.39	0.44		0.80	

Lanes, Volumes, Timings
 10: E. Franklin Street & Henderson Street

09/01/2020



Lane Group	EBL	EBT	WBT	WBR	SBL	SBR
Control Delay		9.0	5.5		40.3	
Queue Delay		0.0	0.0		0.0	
Total Delay		9.0	5.5		40.3	
LOS		A	A		D	
Approach Delay		9.0	5.5		40.3	
Approach LOS		A	A		D	
Queue Length 50th (ft)		191	70		110	
Queue Length 95th (ft)		m165	147		131	
Internal Link Dist (ft)		861	1120		286	
Turn Bay Length (ft)						
Base Capacity (vph)		1823	1774		436	
Starvation Cap Reductn		0	0		0	
Spillback Cap Reductn		0	0		0	
Storage Cap Reductn		0	0		0	
Reduced v/c Ratio		0.39	0.44		0.58	

Intersection Summary

Area Type:	CBD
Cycle Length:	70
Actuated Cycle Length:	70
Offset:	27 (39%), Referenced to phase 2:EBTL and 6:WBT, Start of Green
Natural Cycle:	50
Control Type:	Actuated-Coordinated
Maximum v/c Ratio:	0.80
Intersection Signal Delay:	12.0
Intersection LOS:	B
Intersection Capacity Utilization:	71.0%
ICU Level of Service:	C
Analysis Period (min):	15
m Volume for 95th percentile queue is metered by upstream signal.	

Splits and Phases: 10: E. Franklin Street & Henderson Street

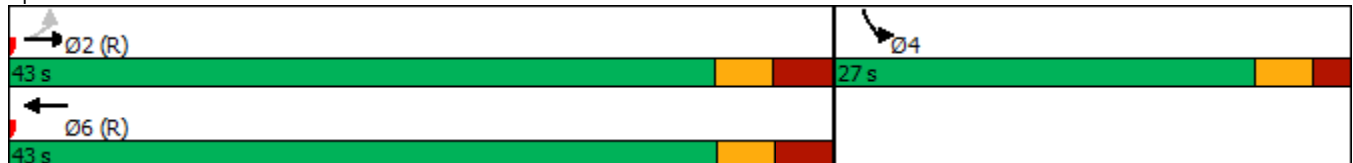

Lanes, Volumes, Timings

11: Raleigh Street/Hillsborough Street & E. Franklin Street

09/01/2020



Lane Group	EBL	EBT	EBR	WBL	WBT	WBR	NBL	NBT	NBR	SBL	SBT	SBR
Lane Configurations												
Traffic Volume (vph)	52	545	234	63	669	242	51	199	23	55	203	13
Future Volume (vph)	52	545	234	63	669	242	51	199	23	55	203	13
Ideal Flow (vphpl)	1900	1900	1900	1900	1900	1900	1900	1900	1900	1900	1900	1900
Lane Width (ft)	9	9	10	9	10	11	12	12	12	10	10	10
Grade (%)		1%			-2%			1%			1%	
Storage Length (ft)	75		0	75		0	0		0	100		0
Storage Lanes	1		0	1		0	0		0	1		0
Taper Length (ft)	25			25			25			25		
Lane Util. Factor	1.00	0.95	0.95	1.00	0.95	0.95	1.00	1.00	1.00	1.00	1.00	1.00
Ped Bike Factor	1.00	0.99		1.00	0.99			0.99		0.99	0.99	
Frt		0.955			0.960			0.989			0.991	
Flt Protected	0.950			0.950				0.991		0.950		
Satd. Flow (prot)	1585	2995	0	1609	3173	0	0	1813	0	1643	1702	0
Flt Permitted	0.247			0.294				0.699		0.401		
Satd. Flow (perm)	411	2995	0	496	3173	0	0	1266	0	690	1702	0
Right Turn on Red			No			No			No			No
Satd. Flow (RTOR)												
Link Speed (mph)		20			30			25			25	
Link Distance (ft)		1200			1013			995			363	
Travel Time (s)		40.9			23.0			27.1			9.9	
Confl. Peds. (#/hr)	16		16	16		16	58		7	7		58
Peak Hour Factor	0.91	0.91	0.91	0.92	0.92	0.92	0.93	0.93	0.93	0.88	0.88	0.88
Adj. Flow (vph)	57	599	257	68	727	263	55	214	25	63	231	15
Shared Lane Traffic (%)												
Lane Group Flow (vph)	57	856	0	68	990	0	0	294	0	63	246	0
Turn Type	Perm	NA		Perm	NA		pm+pt	NA		D.Pm	NA	
Protected Phases		2			6		7	4			8	
Permitted Phases	2			6			4			4		
Detector Phase	2	2		6	6		7	4		4	8	
Switch Phase												
Minimum Initial (s)	10.0	10.0		10.0	10.0		7.0	7.0		7.0	7.0	
Minimum Split (s)	16.0	16.0		16.0	16.0		14.0	30.0		30.0	29.0	
Total Split (s)	79.0	79.0		79.0	79.0		14.0	61.0		61.0	47.0	
Total Split (%)	56.4%	56.4%		56.4%	56.4%		10.0%	43.6%		43.6%	33.6%	
Maximum Green (s)	73.7	73.7		73.7	73.7		7.8	54.6		54.6	40.6	
Yellow Time (s)	3.0	3.0		3.0	3.0		3.0	3.1		3.1	3.1	
All-Red Time (s)	2.3	2.3		2.3	2.3		3.2	3.3		3.3	3.3	
Lost Time Adjust (s)	-0.3	-0.3		-0.3	-0.3			-1.4		-1.4	-1.4	
Total Lost Time (s)	5.0	5.0		5.0	5.0			5.0		5.0	5.0	
Lead/Lag							Lead				Lag	
Lead-Lag Optimize?												
Vehicle Extension (s)	3.0	3.0		3.0	3.0		3.0	2.0		2.0	2.0	
Recall Mode	C-Max	C-Max		C-Max	C-Max		None	None		None	None	
Walk Time (s)								7.0		7.0	7.0	
Flash Dont Walk (s)								16.0		16.0	15.0	
Pedestrian Calls (#/hr)								0		0	0	
Act Effect Green (s)	93.8	93.8		93.8	93.8			36.2		36.2	36.2	
Actuated g/C Ratio	0.67	0.67		0.67	0.67			0.26		0.26	0.26	

Lanes, Volumes, Timings

11: Raleigh Street/Hillsborough Street & E. Franklin Street

09/01/2020



Lane Group	EBL	EBT	EBR	WBL	WBT	WBR	NBL	NBT	NBR	SBL	SBT	SBR
v/c Ratio	0.21	0.43		0.20	0.47			0.90		0.35	0.56	
Control Delay	6.2	5.1		12.9	13.1			78.8		40.5	43.1	
Queue Delay	0.0	0.0		0.0	0.0			0.0		0.0	1.0	
Total Delay	6.2	5.1		12.9	13.1			78.8		40.5	44.1	
LOS	A	A		B	B			E		D	D	
Approach Delay		5.2			13.1			78.8			43.4	
Approach LOS		A			B			E			D	
Queue Length 50th (ft)	8	68		22	212			260		44	172	
Queue Length 95th (ft)	m20	98		59	328			342		74	215	
Internal Link Dist (ft)		1120			933			915			283	
Turn Bay Length (ft)	75			75						100		
Base Capacity (vph)	275	2006		332	2125			506		276	523	
Starvation Cap Reductn	0	0		0	0			0		0	108	
Spillback Cap Reductn	0	0		0	0			0		0	0	
Storage Cap Reductn	0	0		0	0			0		0	0	
Reduced v/c Ratio	0.21	0.43		0.20	0.47			0.58		0.23	0.59	

Intersection Summary





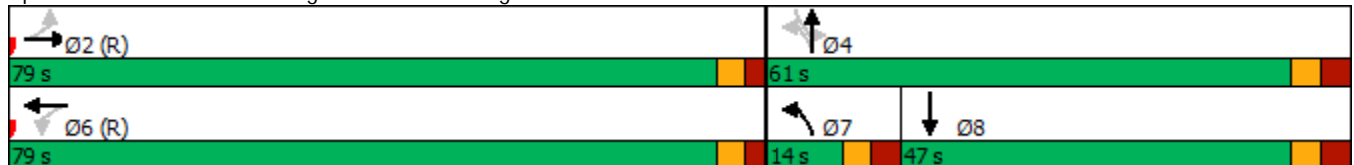













Area Type: Other
 Cycle Length: 140
 Actuated Cycle Length: 140
 Offset: 73 (52%), Referenced to phase 2:EBTL and 6:WBTL, Start of Green
 Natural Cycle: 70
 Control Type: Actuated-Coordinated
 Maximum v/c Ratio: 0.90
 Intersection Signal Delay: 21.4
 Intersection LOS: C
 Intersection Capacity Utilization 84.7%
 ICU Level of Service E
 Analysis Period (min) 15
 m Volume for 95th percentile queue is metered by upstream signal.

Splits and Phases: 11: Raleigh Street/Hillsborough Street & E. Franklin Street



Lanes, Volumes, Timings

13: NC 86 (N. Columbia St)/NC 86 (MLK Jr. Blvd) & North Street & N. Columbia Street 09/01/2020

												
Lane Group	WBL	WBR	WBR2	NBL	NBT	NBR	SBL	SBT	SBR	SEL2	SEL	SER
Lane Configurations												
Traffic Volume (vph)	24	21	148	49	800	23	54	731	6	4	5	101
Future Volume (vph)	24	21	148	49	800	23	54	731	6	4	5	101
Ideal Flow (vphpl)	1900	1900	1900	1900	1900	1900	1900	1900	1900	1900	1900	1900
Grade (%)	2%				-5%			5%				-3%
Storage Length (ft)	0	0		150		0	70		0		0	0
Storage Lanes	1	0		1		0	1		0		1	0
Taper Length (ft)	25			25			25				25	
Lane Util. Factor	1.00	1.00	1.00	1.00	0.95	0.95	1.00	0.95	0.95	1.00	1.00	1.00
Ped Bike Factor				1.00	1.00		0.99	1.00			1.00	
Frt	0.882				0.996			0.999				0.875
Flt Protected	0.994			0.950			0.950				0.996	
Satd. Flow (prot)	1617	0	0	1796	3573	0	1709	3413	0	0	1601	0
Flt Permitted	0.994			0.283			0.226				0.996	
Satd. Flow (perm)	1617	0	0	534	3573	0	404	3413	0	0	1598	0
Right Turn on Red			No			No			No			No
Satd. Flow (RTOR)												
Link Speed (mph)	20				35			35				25
Link Distance (ft)	246				476			2108				715
Travel Time (s)	8.4				9.3			41.1				19.5
Confl. Peds. (#/hr)				7		32	32		7	8		
Peak Hour Factor	0.87	0.87	0.87	0.83	0.83	0.83	0.88	0.88	0.88	0.92	0.92	0.92
Heavy Vehicles (%)	2%	2%	2%	3%	3%	3%	3%	3%	3%	5%	5%	5%
Adj. Flow (vph)	28	24	170	59	964	28	61	831	7	4	5	110
Shared Lane Traffic (%)												
Lane Group Flow (vph)	222	0	0	59	992	0	61	838	0	0	119	0
Turn Type	Prot			Perm	NA		Perm	NA		Prot	Prot	
Protected Phases	3				2			6		4	4	
Permitted Phases				2			6					
Detector Phase	3			2	2		6	6		4	4	
Switch Phase												
Minimum Initial (s)	7.0			10.0	10.0		10.0	10.0		7.0	7.0	
Minimum Split (s)	14.0			17.0	17.0		17.0	17.0		14.0	14.0	
Total Split (s)	35.0			82.0	82.0		82.0	82.0		23.0	23.0	
Total Split (%)	25.0%			58.6%	58.6%		58.6%	58.6%		16.4%	16.4%	
Maximum Green (s)	28.0			75.0	75.0		75.0	75.0		16.0	16.0	
Yellow Time (s)	5.0			5.0	5.0		5.0	5.0		5.0	5.0	
All-Red Time (s)	2.0			2.0	2.0		2.0	2.0		2.0	2.0	
Lost Time Adjust (s)	-2.0			-2.0	-2.0		-2.0	-2.0			-2.0	
Total Lost Time (s)	5.0			5.0	5.0		5.0	5.0			5.0	
Lead/Lag	Lead									Lag	Lag	
Lead-Lag Optimize?	Yes									Yes	Yes	
Vehicle Extension (s)	3.0			3.0	3.0		3.0	3.0		3.0	3.0	
Recall Mode	None			C-Max	C-Max		C-Max	C-Max		None	None	
Act Effect Green (s)	25.4			83.4	83.4		83.4	83.4			16.1	
Actuated g/C Ratio	0.18			0.60	0.60		0.60	0.60			0.12	
v/c Ratio	0.76			0.19	0.47		0.25	0.41			0.65	
Control Delay	70.5			12.7	12.7		19.1	16.8			75.4	
Queue Delay	0.0			0.0	0.4		0.0	0.0			0.0	

Lanes, Volumes, Timings

13: NC 86 (N. Columbia St)/NC 86 (MLK Jr. Blvd) & North Street & N. Columbia Street 09/01/2020



Lane Group	WBL	WBR	WBR2	NBL	NBT	NBR	SBL	SBT	SBR	SEL2	SEL	SER
Total Delay	70.5			12.7	13.1		19.1	16.8			75.4	
LOS	E			B	B		B	B			E	
Approach Delay	70.5				13.0			17.0			75.4	
Approach LOS	E				B			B			E	
Queue Length 50th (ft)	192			15	128		26	215			104	
Queue Length 95th (ft)	267			m21	m155		61	274			173	
Internal Link Dist (ft)	166				396			2028			635	
Turn Bay Length (ft)				150			70					
Base Capacity (vph)	346			318	2129		240	2033			206	
Starvation Cap Reductn	0			0	571		0	0			0	
Spillback Cap Reductn	0			0	0		0	0			0	
Storage Cap Reductn	0			0	0		0	0			0	
Reduced v/c Ratio	0.64			0.19	0.64		0.25	0.41			0.58	

Intersection Summary

Area Type: Other
 Cycle Length: 140
 Actuated Cycle Length: 140
 Offset: 63 (45%), Referenced to phase 2:NBTL and 6:SBTL, Start of Green
 Natural Cycle: 60
 Control Type: Actuated-Coordinated
 Maximum v/c Ratio: 0.76
 Intersection Signal Delay: 23.4 Intersection LOS: C
 Intersection Capacity Utilization 66.4% ICU Level of Service C
 Analysis Period (min) 15
 m Volume for 95th percentile queue is metered by upstream signal.

Splits and Phases: 13: NC 86 (N. Columbia St)/NC 86 (MLK Jr. Blvd) & North Street & N. Columbia Street

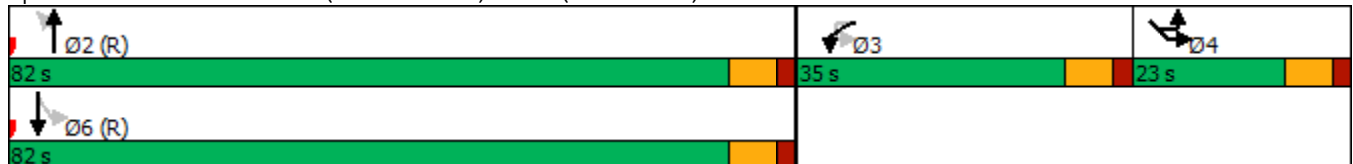

Lanes, Volumes, Timings

14: NC 86 (MLK Jr. Blvd) & Longview Street/Mill Creek Apts Driveway

09/01/2020

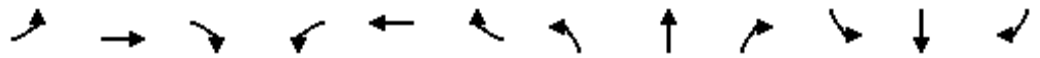

Lane Group	EBL	EBT	EBR	WBL	WBT	WBR	NBL	NBT	NBR	SBL	SBT	SBR
Lane Configurations		↕			↕		↕	↕↔		↕	↕↔	
Traffic Volume (vph)	97	2	18	34	1	8	14	929	13	11	666	78
Future Volume (vph)	97	2	18	34	1	8	14	929	13	11	666	78
Ideal Flow (vphpl)	1900	1900	1900	1900	1900	1900	1900	1900	1900	1900	1900	1900
Grade (%)		-6%			1%			2%			-4%	
Storage Length (ft)	0		0	0		0	225		0	250		0
Storage Lanes	0		0	0		0	1		0	1		0
Taper Length (ft)	25			25			25			25		
Lane Util. Factor	1.00	1.00	1.00	1.00	1.00	1.00	1.00	0.95	0.95	1.00	0.95	0.95
Ped Bike Factor		0.99			0.99		0.99	1.00		0.99	1.00	
Frt		0.979			0.974			0.998			0.984	
Flt Protected		0.960			0.962		0.950			0.950		
Satd. Flow (prot)	0	1795	0	0	1732	0	1735	3459	0	1787	3504	0
Flt Permitted		0.722			0.754		0.339			0.223		
Satd. Flow (perm)	0	1348	0	0	1341	0	616	3459	0	415	3504	0
Right Turn on Red			No			No			No			No
Satd. Flow (RTOR)												
Link Speed (mph)		25			20			35			35	
Link Distance (ft)		451			338			2108			784	
Travel Time (s)		12.3			11.5			41.1			15.3	
Confl. Peds. (#/hr)	2		20	20		2	7		28	28		7
Peak Hour Factor	0.89	0.89	0.89	0.75	0.75	0.75	0.86	0.86	0.86	0.93	0.93	0.93
Heavy Vehicles (%)	2%	2%	2%	2%	2%	2%	3%	3%	3%	3%	3%	3%
Adj. Flow (vph)	109	2	20	45	1	11	16	1080	15	12	716	84
Shared Lane Traffic (%)												
Lane Group Flow (vph)	0	131	0	0	57	0	16	1095	0	12	800	0
Turn Type	Perm	NA		Perm	NA		Perm	NA		Perm	NA	
Protected Phases		4			8			2			6	
Permitted Phases	4			8			2			6		
Detector Phase	4	4		8	8		2	2		6	6	
Switch Phase												
Minimum Initial (s)	7.0	7.0		7.0	7.0		12.0	12.0		12.0	12.0	
Minimum Split (s)	31.0	31.0		14.0	14.0		28.0	28.0		28.0	28.0	
Total Split (s)	20.0	20.0		20.0	20.0		60.0	60.0		60.0	60.0	
Total Split (%)	25.0%	25.0%		25.0%	25.0%		75.0%	75.0%		75.0%	75.0%	
Maximum Green (s)	14.0	14.0		13.9	13.9		54.0	54.0		54.5	54.5	
Yellow Time (s)	3.5	3.5		3.0	3.0		4.5	4.5		4.0	4.0	
All-Red Time (s)	2.5	2.5		3.1	3.1		1.5	1.5		1.5	1.5	
Lost Time Adjust (s)		-1.0			-1.0		-1.0	-1.0		-0.5	-0.5	
Total Lost Time (s)		5.0			5.1		5.0	5.0		5.0	5.0	
Lead/Lag												
Lead-Lag Optimize?												
Vehicle Extension (s)	3.0	3.0		3.0	3.0		3.0	3.0		3.0	3.0	
Recall Mode	None	None		None	None		Min	Min		Min	Min	
Walk Time (s)	7.0	7.0					7.0	7.0		7.0	7.0	
Flash Dont Walk (s)	17.0	17.0					9.0	9.0		9.0	9.0	
Pedestrian Calls (#/hr)	0	0					0	0		0	0	
Act Effct Green (s)		11.0			10.9		28.9	28.9		28.9	28.9	
Actuated g/C Ratio		0.24			0.24		0.64	0.64		0.64	0.64	

Lanes, Volumes, Timings

14: NC 86 (MLK Jr. Blvd) & Longview Street/Mill Creek Apts Driveway

09/01/2020



Lane Group	EBL	EBT	EBR	WBL	WBT	WBR	NBL	NBT	NBR	SBL	SBT	SBR
v/c Ratio		0.40			0.18		0.04	0.50		0.05	0.36	
Control Delay		20.7			17.4		5.7	7.5		5.9	6.4	
Queue Delay		0.0			0.0		0.0	0.0		0.0	0.0	
Total Delay		20.7			17.4		5.7	7.5		5.9	6.4	
LOS		C			B		A	A		A	A	
Approach Delay		20.7			17.4			7.4			6.3	
Approach LOS		C			B			A			A	
Queue Length 50th (ft)		28			12		2	85		1	55	
Queue Length 95th (ft)		81			34		9	145		8	103	
Internal Link Dist (ft)		371			258			2028			704	
Turn Bay Length (ft)							225			250		
Base Capacity (vph)		464			459		607	3408		409	3452	
Starvation Cap Reductn		0			0		0	0		0	0	
Spillback Cap Reductn		0			0		0	0		0	0	
Storage Cap Reductn		0			0		0	0		0	0	
Reduced v/c Ratio		0.28			0.12		0.03	0.32		0.03	0.23	

Intersection Summary

Area Type:	Other
Cycle Length:	80
Actuated Cycle Length:	45.3
Natural Cycle:	60
Control Type:	Actuated-Uncoordinated
Maximum v/c Ratio:	0.50
Intersection Signal Delay:	8.1
Intersection LOS:	A
Intersection Capacity Utilization:	48.1%
ICU Level of Service:	A
Analysis Period (min):	15

Splits and Phases: 14: NC 86 (MLK Jr. Blvd) & Longview Street/Mill Creek Apts Driveway



Lanes, Volumes, Timings
 15: NC 86 (Pittsboro St) & W. Cameron Avenue

09/01/2020



Lane Group	EBT	EBR	WBL	WBT	NBL	NBR	Ø1	Ø4
Lane Configurations	↶		↶↶	↶				
Traffic Volume (vph)	149	222	549	363	0	0		
Future Volume (vph)	149	222	549	363	0	0		
Ideal Flow (vphpl)	1900	1900	1900	1900	1900	1900		
Lane Width (ft)	12	12	11	12	12	12		
Grade (%)	3%			-3%	0%			
Storage Length (ft)		0	75		0	0		
Storage Lanes		0	0		0	0		
Taper Length (ft)			25		25			
Lane Util. Factor	1.00	1.00	0.97	1.00	1.00	1.00		
Ped Bike Factor	0.84		0.74					
Frt	0.919							
Flt Protected			0.950					
Satd. Flow (prot)	1269	0	2890	1622	0	0		
Flt Permitted			0.950					
Satd. Flow (perm)	1269	0	2150	1622	0	0		
Right Turn on Red		No				No		
Satd. Flow (RTOR)								
Link Speed (mph)	25			25	25			
Link Distance (ft)	391			120	794			
Travel Time (s)	30.0			10.7	21.7			
Confl. Peds. (#/hr)		70	70					
Peak Hour Factor	0.93	0.93	0.96	0.96	0.90	0.90		
Heavy Vehicles (%)	2%	2%	7%	7%	2%	2%		
Adj. Flow (vph)	160	239	572	378	0	0		
Shared Lane Traffic (%)								
Lane Group Flow (vph)	399	0	572	378	0	0		
Turn Type	NA		Prot	NA				
Protected Phases	2		1 4	6			1	4
Permitted Phases								
Detector Phase	2		1 4	6				
Switch Phase								
Minimum Initial (s)	10.0			10.0			7.0	7.0
Minimum Split (s)	20.1			20.0			20.0	21.0
Total Split (s)	44.0			102.0			58.0	38.0
Total Split (%)	31.4%			72.9%			41%	27%
Maximum Green (s)	38.9			97.0			52.9	34.0
Yellow Time (s)	3.0			3.3			3.0	3.0
All-Red Time (s)	2.1			1.7			2.1	1.0
Lost Time Adjust (s)	-0.1			0.0				
Total Lost Time (s)	5.0			5.0				
Lead/Lag	Lead						Lag	
Lead-Lag Optimize?								
Vehicle Extension (s)	1.0			1.0			4.0	0.2
Recall Mode	None			C-Max			C-Max	None
Walk Time (s)	7.0							7.0
Flash Dont Walk (s)	4.0							9.0
Pedestrian Calls (#/hr)	0							0
Act Effect Green (s)	57.6		72.4	124.0				

Lanes, Volumes, Timings
 15: NC 86 (Pittsboro St) & W. Cameron Avenue

09/01/2020



Lane Group	EBT	EBR	WBL	WBT	NBL	NBR	Ø1	Ø4
Actuated g/C Ratio	0.41		0.52	0.89				
v/c Ratio	0.77		0.38	0.26				
Control Delay	47.5		13.5	0.9				
Queue Delay	0.0		0.1	0.8				
Total Delay	47.5		13.6	1.6				
LOS	D		B	A				
Approach Delay	47.5			8.9				
Approach LOS	D			A				
Queue Length 50th (ft)	325		83	6				
Queue Length 95th (ft)	447		m117	m41				
Internal Link Dist (ft)	311			40	714			
Turn Bay Length (ft)			75					
Base Capacity (vph)	521		2052	1436				
Starvation Cap Reductn	0		509	734				
Spillback Cap Reductn	0		0	0				
Storage Cap Reductn	0		0	0				
Reduced v/c Ratio	0.77		0.37	0.54				

Intersection Summary

Area Type: CBD
 Cycle Length: 140
 Actuated Cycle Length: 140
 Offset: 104 (74%), Referenced to phase 1:WBL and 6:WBT, Start of Green
 Natural Cycle: 70
 Control Type: Actuated-Coordinated
 Maximum v/c Ratio: 0.77
 Intersection Signal Delay: 20.3
 Intersection LOS: C
 Intersection Capacity Utilization 52.5%
 ICU Level of Service A
 Analysis Period (min) 15
 m Volume for 95th percentile queue is metered by upstream signal.

Splits and Phases: 15: NC 86 (Pittsboro St) & W. Cameron Avenue

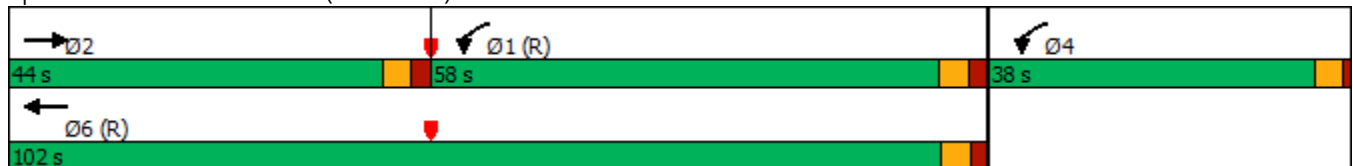

Lanes, Volumes, Timings

16: NC 86 (S. Columbia St) & W. Cameron Avenue/E. Cameron Avenue

09/01/2020



Lane Group	EBL	EBT	EBR	WBL	WBT	WBR	NBL	NBT	NBR	SBL	SBT	SBR
Lane Configurations												
Traffic Volume (vph)	20	123	0	0	168	52	222	671	60	120	0	509
Future Volume (vph)	20	123	0	0	168	52	222	671	60	120	0	509
Ideal Flow (vphpl)	1900	1900	1900	1900	1900	1900	1900	1900	1900	1900	1900	1900
Lane Width (ft)	11	12	12	12	12	12	10	10	10	11	11	12
Grade (%)		1%			-1%			1%			2%	
Storage Length (ft)	100		0	0		0	0		0	310		0
Storage Lanes	1		0	0		0	1		0	1		2
Taper Length (ft)	25			25			25			25		
Lane Util. Factor	1.00	1.00	1.00	1.00	1.00	1.00	0.91	0.91	0.95	1.00	1.00	0.88
Ped Bike Factor	0.86				0.93		0.68	0.94		0.79		0.60
Frt					0.968			0.988				0.850
Flt Protected	0.950						0.950	0.999		0.950		
Satd. Flow (prot)	1532	1668	0	0	1493	0	1295	2542	0	1453	0	2367
Flt Permitted	0.290						0.950	0.999		0.950		
Satd. Flow (perm)	401	1668	0	0	1493	0	884	2518	0	1152	0	1418
Right Turn on Red			No			No			No			No
Satd. Flow (RTOR)												
Link Speed (mph)		25			25			25				25
Link Distance (ft)		273			989			826				981
Travel Time (s)		10.7			57.6			22.5				26.8
Confl. Peds. (#/hr)	157		172	172		157	111		248	248		111
Peak Hour Factor	0.91	0.91	0.91	0.90	0.90	0.90	0.87	0.87	0.87	0.85	0.85	0.85
Heavy Vehicles (%)	2%	2%	2%	4%	4%	4%	6%	6%	6%	7%	7%	7%
Adj. Flow (vph)	22	135	0	0	187	58	255	771	69	141	0	599
Shared Lane Traffic (%)							10%					
Lane Group Flow (vph)	22	135	0	0	245	0	229	866	0	141	0	599
Turn Type	Perm	NA			NA		Split	NA		Prot		Prot
Protected Phases		4			8		2	2		1		1
Permitted Phases	4									1		1
Detector Phase	4	4			8		2	2		1		1
Switch Phase												
Minimum Initial (s)	10.0	10.0			10.0		7.0	7.0		7.0		7.0
Minimum Split (s)	24.0	24.0			31.0		18.0	18.0		26.0		26.0
Total Split (s)	31.0	31.0			31.0		47.0	47.0		34.0		34.0
Total Split (%)	22.1%	22.1%			22.1%		33.6%	33.6%		24.3%		24.3%
Maximum Green (s)	24.8	24.8			24.8		41.1	41.1		28.4		28.4
Yellow Time (s)	3.2	3.2			3.2		3.1	3.1		3.0		3.0
All-Red Time (s)	3.0	3.0			3.0		2.8	2.8		2.6		2.6
Lost Time Adjust (s)	-1.2	-1.2			-1.2		-0.9	-0.9		-0.6		-0.6
Total Lost Time (s)	5.0	5.0			5.0		5.0	5.0		5.0		5.0
Lead/Lag							Lag	Lag		Lead		Lead
Lead-Lag Optimize?												
Vehicle Extension (s)	2.0	2.0			2.0		4.0	4.0		4.0		4.0
Recall Mode	None	None			None		C-Max	C-Max		None		None
Walk Time (s)	7.0	7.0			7.0		7.0	7.0		7.0		7.0
Flash Dont Walk (s)	10.0	10.0			17.0		5.0	5.0		13.0		13.0
Pedestrian Calls (#/hr)	0	0			0		0	0		0		0
Act Effct Green (s)	25.1	25.1			25.1		46.4	46.4		53.5		53.5

Lanes, Volumes, Timings

16: NC 86 (S. Columbia St) & W. Cameron Avenue/E. Cameron Avenue

09/01/2020

Lane Group	Ø9
Lane Configurations	
Traffic Volume (vph)	
Future Volume (vph)	
Ideal Flow (vphpl)	
Lane Width (ft)	
Grade (%)	
Storage Length (ft)	
Storage Lanes	
Taper Length (ft)	
Lane Util. Factor	
Ped Bike Factor	
Flt	
Flt Protected	
Satd. Flow (prot)	
Flt Permitted	
Satd. Flow (perm)	
Right Turn on Red	
Satd. Flow (RTOR)	
Link Speed (mph)	
Link Distance (ft)	
Travel Time (s)	
Confl. Peds. (#/hr)	
Peak Hour Factor	
Heavy Vehicles (%)	
Adj. Flow (vph)	
Shared Lane Traffic (%)	
Lane Group Flow (vph)	
Turn Type	
Protected Phases	9
Permitted Phases	
Detector Phase	
Switch Phase	
Minimum Initial (s)	7.0
Minimum Split (s)	28.0
Total Split (s)	28.0
Total Split (%)	20%
Maximum Green (s)	24.0
Yellow Time (s)	3.0
All-Red Time (s)	1.0
Lost Time Adjust (s)	
Total Lost Time (s)	
Lead/Lag	
Lead-Lag Optimize?	
Vehicle Extension (s)	0.2
Recall Mode	None
Walk Time (s)	7.0
Flash Dont Walk (s)	17.0
Pedestrian Calls (#/hr)	0
Act Effect Green (s)	

Lanes, Volumes, Timings

16: NC 86 (S. Columbia St) & W. Cameron Avenue/E. Cameron Avenue

09/01/2020



Lane Group	EBL	EBT	EBR	WBL	WBT	WBR	NBL	NBT	NBR	SBL	SBT	SBR
Actuated g/C Ratio	0.18	0.18			0.18		0.33	0.33		0.38		0.38
v/c Ratio	0.31	0.45			0.92		0.53	1.03		0.25		0.66
Control Delay	24.8	21.1			93.4		42.9	83.8		17.7		26.8
Queue Delay	0.0	0.0			0.0		0.0	0.0		0.0		0.0
Total Delay	24.8	21.1			93.4		42.9	83.8		17.7		26.8
LOS	C	C			F		D	F		B		C
Approach Delay		21.6			93.4			75.2			25.1	
Approach LOS		C			F			E			C	
Queue Length 50th (ft)	11	74			220		180	425		86		260
Queue Length 95th (ft)	m16	m104			#377		268	#557		m104		330
Internal Link Dist (ft)		193			909			746			901	
Turn Bay Length (ft)	100									310		
Base Capacity (vph)	74	309			277		429	843		554		904
Starvation Cap Reductn	0	0			0		0	0		0		0
Spillback Cap Reductn	0	0			0		0	0		0		0
Storage Cap Reductn	0	0			0		0	0		0		0
Reduced v/c Ratio	0.30	0.44			0.88		0.53	1.03		0.25		0.66

Intersection Summary

Area Type: CBD
 Cycle Length: 140
 Actuated Cycle Length: 140
 Offset: 23 (16%), Referenced to phase 2:NBTL, Start of Green
 Natural Cycle: 145
 Control Type: Actuated-Coordinated
 Maximum v/c Ratio: 1.03
 Intersection Signal Delay: 56.9 Intersection LOS: E
 Intersection Capacity Utilization 79.9% ICU Level of Service D
 Analysis Period (min) 15
 # 95th percentile volume exceeds capacity, queue may be longer.
 Queue shown is maximum after two cycles.
 m Volume for 95th percentile queue is metered by upstream signal.

Splits and Phases: 16: NC 86 (S. Columbia St) & W. Cameron Avenue/E. Cameron Avenue

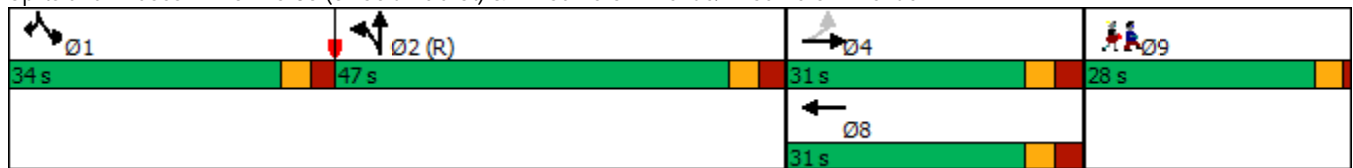

Lanes, Volumes, Timings

16: NC 86 (S. Columbia St) & W. Cameron Avenue/E. Cameron Avenue

09/01/2020

Lane Group	Ø9
Actuated g/C Ratio	
v/c Ratio	
Control Delay	
Queue Delay	
Total Delay	
LOS	
Approach Delay	
Approach LOS	
Queue Length 50th (ft)	
Queue Length 95th (ft)	
Internal Link Dist (ft)	
Turn Bay Length (ft)	
Base Capacity (vph)	
Starvation Cap Reductn	
Spillback Cap Reductn	
Storage Cap Reductn	
Reduced v/c Ratio	
Intersection Summary	

Lanes, Volumes, Timings

17: Raleigh Street & E. Cameron Avenue/Country Club Road

09/01/2020

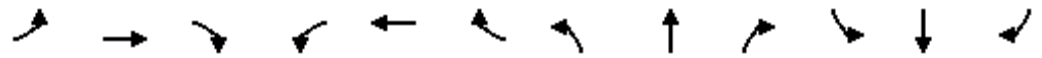

Lane Group	EBL	EBT	EBR	WBL	WBT	WBR	NBL	NBT	NBR	SBL	SBT	SBR
Lane Configurations		↕		↖	↗		↖	↗		↖	↗	
Traffic Volume (vph)	27	164	47	35	130	181	56	93	62	265	188	54
Future Volume (vph)	27	164	47	35	130	181	56	93	62	265	188	54
Ideal Flow (vphpl)	1900	1900	1900	1900	1900	1900	1900	1900	1900	1900	1900	1900
Grade (%)		-3%			3%			-2%				1%
Storage Length (ft)	0		0	150		0	125		0	75		0
Storage Lanes	0		0	1		0	1		0	1		0
Taper Length (ft)	25			25			25			25		
Lane Util. Factor	1.00	1.00	1.00	1.00	1.00	1.00	1.00	1.00	1.00	1.00	1.00	1.00
Ped Bike Factor		0.94			0.88			0.88		0.82	0.88	
Frt		0.973			0.913			0.940			0.967	
Flt Protected		0.994		0.950			0.950			0.950		
Satd. Flow (prot)	0	1572	0	1569	1329	0	1563	1358	0	1585	1418	0
Flt Permitted		0.925		0.371			0.583			0.448		
Satd. Flow (perm)	0	1444	0	613	1329	0	959	1358	0	612	1418	0
Right Turn on Red			No			No			No			No
Satd. Flow (RTOR)												
Link Speed (mph)		25			25			25				25
Link Distance (ft)		598			651			409				995
Travel Time (s)		16.3			17.8			11.2				27.1
Confl. Peds. (#/hr)	39		37	37		39	107		60	60		107
Peak Hour Factor	0.75	0.75	0.75	0.89	0.89	0.89	0.89	0.89	0.89	0.84	0.84	0.84
Heavy Vehicles (%)	2%	2%	2%	2%	2%	2%	5%	5%	5%	2%	2%	2%
Adj. Flow (vph)	36	219	63	39	146	203	63	104	70	315	224	64
Shared Lane Traffic (%)												
Lane Group Flow (vph)	0	318	0	39	349	0	63	174	0	315	288	0
Turn Type	Perm	NA		pm+pt	NA		pm+pt	NA		pm+pt	NA	
Protected Phases		2		1	6		3	8		7	4	
Permitted Phases	2			6			8			4		
Detector Phase	2	2		1	6		3	8		7	4	
Switch Phase												
Minimum Initial (s)	10.0	10.0		7.0	10.0		7.0	7.0		7.0	7.0	
Minimum Split (s)	18.0	18.0		13.0	19.0		13.0	19.0		12.0	16.0	
Total Split (s)	50.0	50.0		20.0	70.0		20.0	35.0		20.0	35.0	
Total Split (%)	40.0%	40.0%		16.0%	56.0%		16.0%	28.0%		16.0%	28.0%	
Maximum Green (s)	43.9	43.9		14.4	64.4		14.7	29.7		15.1	29.9	
Yellow Time (s)	3.3	3.3		3.0	3.1		3.0	3.1		3.0	3.1	
All-Red Time (s)	2.8	2.8		2.6	2.5		2.3	2.2		1.9	2.0	
Lost Time Adjust (s)		-1.1		-0.6	-0.6		-0.3	-0.3		0.1	-0.1	
Total Lost Time (s)		5.0		5.0	5.0		5.0	5.0		5.0	5.0	
Lead/Lag	Lag	Lag		Lead			Lead	Lag		Lead	Lag	
Lead-Lag Optimize?	Yes	Yes		Yes			Yes	Yes		Yes	Yes	
Vehicle Extension (s)	2.0	2.0		2.0	2.0		2.0	2.0		2.0	2.0	
Recall Mode	None	None		None	None		None	None		None	None	
Walk Time (s)	4.0	4.0			4.0			4.0			4.0	
Flash Dont Walk (s)	7.0	7.0			9.0			9.0			6.0	
Pedestrian Calls (#/hr)	0	0			0			0			0	
Act Effect Green (s)		24.7		31.1	31.1		24.3	15.9		36.9	27.1	
Actuated g/C Ratio		0.31		0.39	0.39		0.31	0.20		0.47	0.34	

Lanes, Volumes, Timings

17: Raleigh Street & E. Cameron Avenue/Country Club Road

09/01/2020



Lane Group	EBL	EBT	EBR	WBL	WBT	WBR	NBL	NBT	NBR	SBL	SBT	SBR
v/c Ratio		0.71		0.11	0.67		0.18	0.64		0.66	0.59	
Control Delay		35.4		15.3	26.1		17.7	43.3		25.9	33.1	
Queue Delay		0.0		0.0	0.0		0.0	0.0		0.0	0.0	
Total Delay		35.4		15.3	26.1		17.7	43.3		25.9	33.1	
LOS		D		B	C		B	D		C	C	
Approach Delay		35.4			25.1			36.5			29.4	
Approach LOS		D			C			D			C	
Queue Length 50th (ft)		149		11	132		19	85		113	135	
Queue Length 95th (ft)		216		32	252		52	175		#221	253	
Internal Link Dist (ft)		518			571			329			915	
Turn Bay Length (ft)				150			125			75		
Base Capacity (vph)		896		445	1083		516	562		487	590	
Starvation Cap Reductn		0		0	0		0	0		0	0	
Spillback Cap Reductn		0		0	0		0	0		0	0	
Storage Cap Reductn		0		0	0		0	0		0	0	
Reduced v/c Ratio		0.35		0.09	0.32		0.12	0.31		0.65	0.49	

Intersection Summary

Area Type: CBD
 Cycle Length: 125
 Actuated Cycle Length: 78.9
 Natural Cycle: 70
 Control Type: Actuated-Uncoordinated
 Maximum v/c Ratio: 0.71
 Intersection Signal Delay: 30.6
 Intersection LOS: C
 Intersection Capacity Utilization 79.5%
 ICU Level of Service D
 Analysis Period (min) 15
 # 95th percentile volume exceeds capacity, queue may be longer.
 Queue shown is maximum after two cycles.

Splits and Phases: 17: Raleigh Street & E. Cameron Avenue/Country Club Road





2023 With Office Building Site

Lanes, Volumes, Timings
1: Church Street & W. Rosemary Street

09/01/2020



Lane Group	EBL	EBT	EBR	WBL	WBT	WBR	NBL	NBT	NBR	SBL	SBT	SBR
Lane Configurations		↕			↕			↕			↕	
Traffic Volume (vph)	14	304	21	33	306	15	33	24	46	27	39	11
Future Volume (vph)	14	304	21	33	306	15	33	24	46	27	39	11
Ideal Flow (vphpl)	1900	1900	1900	1900	1900	1900	1900	1900	1900	1900	1900	1900
Lane Width (ft)	12	14	12	12	14	12	12	12	12	12	12	12
Grade (%)		1%			-1%			0%			0%	
Lane Util. Factor	1.00	1.00	1.00	1.00	1.00	1.00	1.00	1.00	1.00	1.00	1.00	1.00
Ped Bike Factor		0.99			0.99			0.95			0.97	
Frt		0.992			0.994			0.940			0.981	
Flt Protected		0.998			0.995			0.984			0.983	
Satd. Flow (prot)	0	1736	0	0	1737	0	0	1492	0	0	1602	0
Flt Permitted		0.982			0.947			0.888			0.867	
Satd. Flow (perm)	0	1707	0	0	1650	0	0	1330	0	0	1386	0
Right Turn on Red			No			No			No			No
Satd. Flow (RTOR)												
Link Speed (mph)		20			20			25			25	
Link Distance (ft)		964			757			379			430	
Travel Time (s)		32.9			25.8			10.3			11.7	
Confl. Peds. (#/hr)	20		17	17		20	21		31	31		21
Peak Hour Factor	0.86	0.86	0.86	0.89	0.89	0.89	0.84	0.84	0.84	0.72	0.72	0.72
Heavy Vehicles (%)	3%	3%	3%	4%	4%	4%	2%	2%	2%	2%	2%	2%
Adj. Flow (vph)	16	353	24	37	344	17	39	29	55	38	54	15
Shared Lane Traffic (%)												
Lane Group Flow (vph)	0	393	0	0	398	0	0	123	0	0	107	0
Turn Type	Perm	NA		Perm	NA		Perm	NA		Perm	NA	
Protected Phases		2			6			8			4	
Permitted Phases	2			6			8			4		
Detector Phase	2	2		6	6		8	8		4	4	
Switch Phase												
Minimum Initial (s)	10.0	10.0		10.0	10.0		7.0	7.0		7.0	7.0	
Minimum Split (s)	19.0	19.0		20.0	20.0		19.0	19.0		19.0	19.0	
Total Split (s)	38.0	38.0		38.0	38.0		22.0	22.0		22.0	22.0	
Total Split (%)	63.3%	63.3%		63.3%	63.3%		36.7%	36.7%		36.7%	36.7%	
Maximum Green (s)	33.5	33.5		33.4	33.4		17.1	17.1		17.1	17.1	
Yellow Time (s)	3.1	3.1		3.1	3.1		3.2	3.2		3.2	3.2	
All-Red Time (s)	1.4	1.4		1.5	1.5		1.7	1.7		1.7	1.7	
Lost Time Adjust (s)		0.5			0.4			0.1			0.1	
Total Lost Time (s)		5.0			5.0			5.0			5.0	
Lead/Lag												
Lead-Lag Optimize?												
Vehicle Extension (s)	3.0	3.0		3.0	3.0		3.0	3.0		3.0	3.0	
Recall Mode	C-Max	C-Max		C-Max	C-Max		None	None		None	None	
Walk Time (s)	4.0	4.0		4.0	4.0		4.0	4.0		4.0	4.0	
Flash Dont Walk (s)	5.0	5.0		6.0	6.0		10.0	10.0		10.0	10.0	
Pedestrian Calls (#/hr)	0	0		0	0		0	0		0	0	
Act Effct Green (s)		42.5			42.5			10.9			10.9	
Actuated g/C Ratio		0.71			0.71			0.18			0.18	
v/c Ratio		0.33			0.34			0.51			0.43	
Control Delay		6.1			3.7			25.2			26.1	

Lanes, Volumes, Timings
 1: Church Street & W. Rosemary Street

09/01/2020



Lane Group	EBL	EBT	EBR	WBL	WBT	WBR	NBL	NBT	NBR	SBL	SBT	SBR
Queue Delay		0.0			0.0			0.0			0.0	
Total Delay		6.1			3.7			25.2			26.1	
LOS		A			A			C			C	
Approach Delay		6.1			3.7			25.2			26.1	
Approach LOS		A			A			C			C	
Queue Length 50th (ft)		52			17			41			35	
Queue Length 95th (ft)		111			76			52			53	
Internal Link Dist (ft)		884			677			299			350	
Turn Bay Length (ft)												
Base Capacity (vph)		1209			1168			376			392	
Starvation Cap Reductn		0			0			0			0	
Spillback Cap Reductn		0			0			0			0	
Storage Cap Reductn		0			0			0			0	
Reduced v/c Ratio		0.33			0.34			0.33			0.27	

Intersection Summary

Area Type:	CBD
Cycle Length:	60
Actuated Cycle Length:	60
Offset:	7 (12%), Referenced to phase 2:EBTL and 6:WBTL, Start of Green
Natural Cycle:	40
Control Type:	Actuated-Coordinated
Maximum v/c Ratio:	0.51
Intersection Signal Delay:	9.6
Intersection LOS:	A
Intersection Capacity Utilization:	52.7%
ICU Level of Service:	A
Analysis Period (min):	15

Splits and Phases: 1: Church Street & W. Rosemary Street

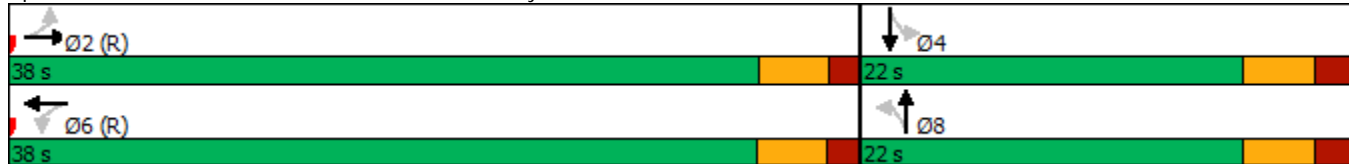

Lanes, Volumes, Timings

2: NC 86 (N. Columbia St) & W. Rosemary Street/E. Rosemary Street

09/01/2020



Lane Group	EBL	EBT	EBR	WBL	WBT	WBR	NBL	NBT	NBR	SBL	SBT	SBR
Lane Configurations												
Traffic Volume (vph)	152	230	21	20	171	31	22	312	111	72	565	178
Future Volume (vph)	152	230	21	20	171	31	22	312	111	72	565	178
Ideal Flow (vphpl)	1900	1900	1900	1900	1900	1900	1900	1900	1900	1900	1900	1900
Lane Width (ft)	9	12	13	12	12	12	9	10	12	12	9	11
Grade (%)		1%			1%			-2%			8%	
Storage Length (ft)	100		0	150		0	75		0	150		400
Storage Lanes	1		0	1		0	1		0	1		1
Taper Length (ft)	25			25			25			25		
Lane Util. Factor	1.00	1.00	1.00	1.00	1.00	1.00	1.00	0.95	0.95	1.00	0.95	1.00
Ped Bike Factor	0.99	1.00		0.98	1.00		0.98	0.96		0.95		0.91
Frt		0.988			0.977			0.961				0.850
Flt Protected	0.950			0.950			0.950			0.950		
Satd. Flow (prot)	1426	1643	0	1585	1623	0	1355	2603	0	1485	2673	1285
Flt Permitted	0.281			0.582			0.349			0.431		
Satd. Flow (perm)	418	1643	0	956	1623	0	489	2603	0	640	2673	1169
Right Turn on Red			No			No			No			No
Satd. Flow (RTOR)												
Link Speed (mph)		20			20			25			25	
Link Distance (ft)		757			461			353			476	
Travel Time (s)		25.8			15.7			9.6			13.0	
Confl. Peds. (#/hr)	12		16	16		12	19		34	34		19
Peak Hour Factor	0.86	0.86	0.86	0.90	0.90	0.90	0.90	0.90	0.90	0.88	0.88	0.88
Heavy Vehicles (%)	2%	2%	2%	2%	2%	2%	9%	9%	9%	5%	5%	5%
Adj. Flow (vph)	177	267	24	22	190	34	24	347	123	82	642	202
Shared Lane Traffic (%)												
Lane Group Flow (vph)	177	291	0	22	224	0	24	470	0	82	642	202
Turn Type	pm+pt	NA		Perm	NA		pm+pt	NA		pm+pt	NA	pm+ov
Protected Phases	7	4			8		5	2		1	6	7
Permitted Phases	4			8			2			6		6
Detector Phase	7	4		8	8		5	2		1	6	7
Switch Phase												
Minimum Initial (s)	7.0	7.0		7.0	7.0		7.0	10.0		7.0	10.0	7.0
Minimum Split (s)	13.0	31.0		32.0	32.0		13.0	23.0		13.0	22.0	13.0
Total Split (s)	23.0	57.0		34.0	34.0		13.0	50.0		13.0	50.0	23.0
Total Split (%)	19.2%	47.5%		28.3%	28.3%		10.8%	41.7%		10.8%	41.7%	19.2%
Maximum Green (s)	17.2	51.0		28.0	28.0		7.2	44.2		7.9	44.2	17.2
Yellow Time (s)	3.0	3.2		3.2	3.2		3.0	3.3		3.0	3.3	3.0
All-Red Time (s)	2.8	2.8		2.8	2.8		2.8	2.5		2.1	2.5	2.8
Lost Time Adjust (s)	-0.8	-1.0		-1.0	-1.0		-1.0	-0.8		-0.1	-0.8	-0.8
Total Lost Time (s)	5.0	5.0		5.0	5.0		4.8	5.0		5.0	5.0	5.0
Lead/Lag	Lead			Lag	Lag		Lead	Lag		Lead	Lag	Lead
Lead-Lag Optimize?												
Vehicle Extension (s)	1.0	1.0		1.0	1.0		1.0	3.0		1.0	3.0	1.0
Recall Mode	None	None		None	None		None	C-Max		None	C-Max	None
Walk Time (s)		7.0		7.0	7.0			7.0			7.0	
Flash Dont Walk (s)		18.0		19.0	19.0			10.0			9.0	
Pedestrian Calls (#/hr)		0		0	0			0			0	
Act Effect Green (s)	42.0	42.0		21.0	21.0		64.5	57.9		65.0	60.3	76.3

Lanes, Volumes, Timings

2: NC 86 (N. Columbia St) & W. Rosemary Street/E. Rosemary Street

09/01/2020

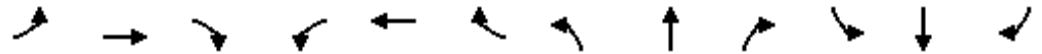

Lane Group	EBL	EBT	EBR	WBL	WBT	WBR	NBL	NBT	NBR	SBL	SBT	SBR
Actuated g/C Ratio	0.35	0.35		0.18	0.18		0.54	0.48		0.54	0.50	0.64
v/c Ratio	0.63	0.51		0.13	0.79		0.07	0.37		0.20	0.48	0.27
Control Delay	38.8	34.3		38.4	60.5		13.0	15.5		13.2	17.1	6.7
Queue Delay	0.0	0.0		0.0	0.0		0.0	0.1		0.0	0.0	0.0
Total Delay	38.8	34.3		38.4	60.5		13.0	15.6		13.2	17.1	6.7
LOS	D	C		D	E		B	B		B	B	A
Approach Delay		36.0			58.5			15.5			14.5	
Approach LOS		D			E			B			B	
Queue Length 50th (ft)	105	182		13	145		5	64		23	116	27
Queue Length 95th (ft)	139	245		37	213		m14	118		41	138	46
Internal Link Dist (ft)		677			381			273			396	
Turn Bay Length (ft)	100			150			75			150		400
Base Capacity (vph)	297	711		231	392		322	1256		404	1344	780
Starvation Cap Reductn	0	0		0	0		0	149		0	0	0
Spillback Cap Reductn	0	0		0	0		0	0		0	35	0
Storage Cap Reductn	0	0		0	0		0	0		0	0	0
Reduced v/c Ratio	0.60	0.41		0.10	0.57		0.07	0.42		0.20	0.49	0.26

Intersection Summary

Area Type: CBD
 Cycle Length: 120
 Actuated Cycle Length: 120
 Offset: 41 (34%), Referenced to phase 2:NBTL and 6:SBTL, Start of Green
 Natural Cycle: 85
 Control Type: Actuated-Coordinated
 Maximum v/c Ratio: 0.79
 Intersection Signal Delay: 24.5 Intersection LOS: C
 Intersection Capacity Utilization 64.4% ICU Level of Service C
 Analysis Period (min) 15
 m Volume for 95th percentile queue is metered by upstream signal.

Splits and Phases: 2: NC 86 (N. Columbia St) & W. Rosemary Street/E. Rosemary Street

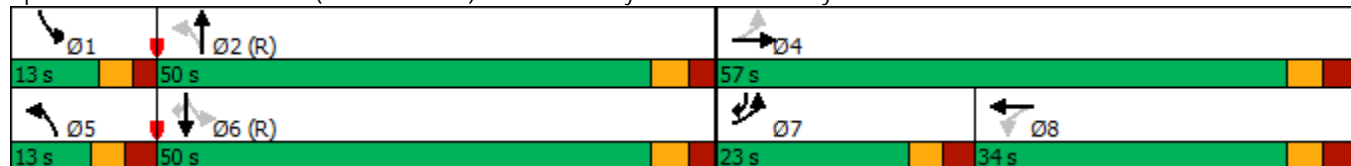

Lanes, Volumes, Timings
6: Henderson Street & E. Rosemary Street

09/01/2020



Lane Group	EBL	EBT	EBR	WBL	WBT	WBR	NBL	NBT	NBR	SBL	SBT	SBR
Lane Configurations												
Traffic Volume (vph)	5	143	63	8	270	16	77	6	8	9	17	5
Future Volume (vph)	5	143	63	8	270	16	77	6	8	9	17	5
Ideal Flow (vphpl)	1900	1900	1900	1900	1900	1900	1900	1900	1900	1900	1900	1900
Grade (%)		0%			0%			0%				3%
Storage Length (ft)	85		0	0		0	0		0	0		0
Storage Lanes	1		0	0		0	0		0	0		0
Taper Length (ft)	25			25			25			25		
Lane Util. Factor	1.00	1.00	1.00	1.00	1.00	1.00	1.00	1.00	1.00	1.00	1.00	1.00
Ped Bike Factor	0.99	0.99			1.00			0.95				0.98
Frt		0.954			0.993			0.988				0.979
Flt Protected	0.950				0.999			0.959				0.986
Satd. Flow (prot)	1593	1582	0	0	1660	0	0	1563	0	0	1561	0
Flt Permitted	0.565				0.992			0.727				0.888
Satd. Flow (perm)	942	1582	0	0	1648	0	0	1137	0	0	1388	0
Right Turn on Red			No			No			No			No
Satd. Flow (RTOR)												
Link Speed (mph)		20			20			20				20
Link Distance (ft)		242			1195			366				450
Travel Time (s)		8.3			40.7			12.5				15.3
Confl. Peds. (#/hr)	4		6	6		4	22		23	23		22
Peak Hour Factor	0.89	0.89	0.89	0.75	0.75	0.75	0.87	0.87	0.87	0.68	0.68	0.68
Heavy Vehicles (%)	2%	2%	2%	2%	2%	2%	3%	3%	3%	3%	3%	3%
Adj. Flow (vph)	6	161	71	11	360	21	89	7	9	13	25	7
Shared Lane Traffic (%)												
Lane Group Flow (vph)	6	232	0	0	392	0	0	105	0	0	45	0
Turn Type	Perm	NA		Perm	NA		Perm	NA		Perm	NA	
Protected Phases		2			2			4				4
Permitted Phases	2			2			4			4		
Detector Phase	2	2		2	2		4	4		4	4	
Switch Phase												
Minimum Initial (s)	11.0	11.0		11.0	11.0		8.0	8.0		8.0	8.0	
Minimum Split (s)	15.9	15.9		15.9	15.9		17.8	17.8		17.8	17.8	
Total Split (s)	40.0	40.0		40.0	40.0		20.0	20.0		20.0	20.0	
Total Split (%)	66.7%	66.7%		66.7%	66.7%		33.3%	33.3%		33.3%	33.3%	
Maximum Green (s)	35.1	35.1		35.1	35.1		15.2	15.2		15.2	15.2	
Yellow Time (s)	3.3	3.3		3.3	3.3		3.3	3.3		3.3	3.3	
All-Red Time (s)	1.6	1.6		1.6	1.6		1.5	1.5		1.5	1.5	
Lost Time Adjust (s)	0.1	0.1			0.1			0.2				0.2
Total Lost Time (s)	5.0	5.0			5.0			5.0				5.0
Lead/Lag												
Lead-Lag Optimize?												
Vehicle Extension (s)	2.0	2.0		2.0	2.0		2.0	2.0		2.0	2.0	
Recall Mode	C-Max	C-Max		C-Max	C-Max		None	None		None	None	
Walk Time (s)	4.0	4.0		4.0	4.0		4.0	4.0		4.0	4.0	
Flash Dont Walk (s)	7.0	7.0		7.0	7.0		9.0	9.0		9.0	9.0	
Pedestrian Calls (#/hr)	0	0		0	0		0	0		0	0	
Act Effect Green (s)	43.2	43.2			43.2			10.4				10.4
Actuated g/C Ratio	0.72	0.72			0.72			0.17				0.17

Lanes, Volumes, Timings
 6: Henderson Street & E. Rosemary Street

09/01/2020



Lane Group	EBL	EBT	EBR	WBL	WBT	WBR	NBL	NBT	NBR	SBL	SBT	SBR
v/c Ratio	0.01	0.20			0.33			0.54				0.19
Control Delay	6.6	6.1			6.1			29.3				21.7
Queue Delay	0.0	0.0			0.0			0.0				0.0
Total Delay	6.6	6.1			6.1			29.3				21.7
LOS	A	A			A			C				C
Approach Delay		6.1			6.1			29.3				21.7
Approach LOS		A			A			C				C
Queue Length 50th (ft)	1	45			74			55				14
Queue Length 95th (ft)	m5	88			85			95				26
Internal Link Dist (ft)		162			1115			286				370
Turn Bay Length (ft)	85											
Base Capacity (vph)	677	1138			1186			284				347
Starvation Cap Reductn	0	0			0			0				0
Spillback Cap Reductn	0	0			0			0				0
Storage Cap Reductn	0	0			0			0				0
Reduced v/c Ratio	0.01	0.20			0.33			0.37				0.13

Intersection Summary

Area Type: CBD
 Cycle Length: 60
 Actuated Cycle Length: 60
 Offset: 38 (63%), Referenced to phase 2:EBWB, Start of Green
 Natural Cycle: 40
 Control Type: Actuated-Coordinated
 Maximum v/c Ratio: 0.54
 Intersection Signal Delay: 10.1
 Intersection Capacity Utilization 44.9%
 Analysis Period (min) 15
 Intersection LOS: B
 ICU Level of Service A
 m Volume for 95th percentile queue is metered by upstream signal.

Splits and Phases: 6: Henderson Street & E. Rosemary Street



Lanes, Volumes, Timings
 7: Hillsborough Street & E. Rosemary Street

09/01/2020



Lane Group	EBL	EBT	EBR	WBL	WBT	WBR	NBL	NBT	NBR	SBL	SBT	SBR
Lane Configurations		↕			↕		↗	↘		↗	↘	
Traffic Volume (vph)	8	58	71	0	111	12	154	143	6	21	360	44
Future Volume (vph)	8	58	71	0	111	12	154	143	6	21	360	44
Ideal Flow (vphpl)	1900	1900	1900	1900	1900	1900	1900	1900	1900	1900	1900	1900
Storage Length (ft)	0		0	0		0	100		0	100		0
Storage Lanes	0		0	0		0	1		0	1		0
Taper Length (ft)	25			25			25			25		
Lane Util. Factor	1.00	1.00	1.00	1.00	1.00	1.00	1.00	1.00	1.00	1.00	1.00	1.00
Ped Bike Factor		0.99			1.00			1.00		1.00	0.99	
Frt		0.930			0.987			0.994			0.984	
Flt Protected		0.997					0.950			0.950		
Satd. Flow (prot)	0	1704	0	0	1832	0	1752	1832	0	1752	1804	0
Flt Permitted		0.971					0.363			0.656		
Satd. Flow (perm)	0	1658	0	0	1832	0	670	1832	0	1204	1804	0
Right Turn on Red			No			No			No			No
Satd. Flow (RTOR)												
Link Speed (mph)		20			20			25			25	
Link Distance (ft)		1195			527			363			726	
Travel Time (s)		40.7			18.0			9.9			19.8	
Confl. Peds. (#/hr)	6		3	3		6	13		2	2		13
Peak Hour Factor	0.82	0.82	0.82	0.71	0.71	0.71	0.93	0.93	0.93	0.90	0.90	0.90
Heavy Vehicles (%)	2%	2%	2%	2%	2%	2%	3%	3%	3%	3%	3%	3%
Adj. Flow (vph)	10	71	87	0	156	17	166	154	6	23	400	49
Shared Lane Traffic (%)												
Lane Group Flow (vph)	0	168	0	0	173	0	166	160	0	23	449	0
Turn Type	Perm	NA			NA		pm+pt	NA		Perm	NA	
Protected Phases		4			8		5	2			6	
Permitted Phases	4			8			2			6		
Detector Phase	4	4		8	8		5	2		6	6	
Switch Phase												
Minimum Initial (s)	7.0	7.0		7.0	7.0		7.0	10.0		10.0	10.0	
Minimum Split (s)	20.0	20.0		17.0	17.0		12.0	15.0		15.0	15.0	
Total Split (s)	20.0	20.0		20.0	20.0		12.0	40.0		28.0	28.0	
Total Split (%)	33.3%	33.3%		33.3%	33.3%		20.0%	66.7%		46.7%	46.7%	
Maximum Green (s)	15.1	15.1		15.0	15.0		7.2	35.2		23.2	23.2	
Yellow Time (s)	3.0	3.0		3.3	3.3		3.0	3.3		3.1	3.1	
All-Red Time (s)	1.9	1.9		1.7	1.7		1.8	1.5		1.7	1.7	
Lost Time Adjust (s)		0.1			0.0		0.2	0.2		0.2	0.2	
Total Lost Time (s)		5.0			5.0		5.0	5.0		5.0	5.0	
Lead/Lag							Lead			Lag	Lag	
Lead-Lag Optimize?							Yes			Yes	Yes	
Vehicle Extension (s)	2.0	2.0		2.0	2.0		2.0	2.0		2.0	2.0	
Recall Mode	None	None		None	None		None	C-Max		C-Max	C-Max	
Walk Time (s)	4.0	4.0		4.0	4.0			4.0		4.0	4.0	
Flash Dont Walk (s)	11.0	11.0		8.0	8.0			6.0		6.0	6.0	
Pedestrian Calls (#/hr)	0	0		0	0			0		0	0	
Act Effct Green (s)		10.5			10.5		41.9	42.9		33.3	33.3	
Actuated g/C Ratio		0.18			0.18		0.70	0.72		0.56	0.56	
v/c Ratio		0.58			0.54		0.28	0.12		0.03	0.45	

Lanes, Volumes, Timings
 7: Hillsborough Street & E. Rosemary Street

09/01/2020



Lane Group	EBL	EBT	EBR	WBL	WBT	WBR	NBL	NBT	NBR	SBL	SBT	SBR
Control Delay		29.6			28.4		3.3	2.4		11.0	13.9	
Queue Delay		0.0			0.0		0.0	0.0		0.0	0.0	
Total Delay		29.6			28.4		3.3	2.4		11.0	13.9	
LOS		C			C		A	A		B	B	
Approach Delay		29.6			28.4			2.8				13.8
Approach LOS		C			C			A				B
Queue Length 50th (ft)		61			58		11	11		4	108	
Queue Length 95th (ft)		87			76		23	22		17	217	
Internal Link Dist (ft)		1115			447			283				646
Turn Bay Length (ft)							100			100		
Base Capacity (vph)		414			458		596	1310		667	999	
Starvation Cap Reductn		0			0		0	0		0	0	
Spillback Cap Reductn		0			0		0	0		0	0	
Storage Cap Reductn		0			0		0	0		0	0	
Reduced v/c Ratio		0.41			0.38		0.28	0.12		0.03	0.45	

Intersection Summary

Area Type:	Other
Cycle Length:	60
Actuated Cycle Length:	60
Offset:	14 (23%), Referenced to phase 2:NBTL and 6:SBTL, Start of Green
Natural Cycle:	55
Control Type:	Actuated-Coordinated
Maximum v/c Ratio:	0.58
Intersection Signal Delay:	15.2
Intersection LOS:	B
Intersection Capacity Utilization	57.4%
ICU Level of Service	B
Analysis Period (min)	15

Splits and Phases: 7: Hillsborough Street & E. Rosemary Street



Lanes, Volumes, Timings

8: Carolina Square Driveway/Church Street & W. Franklin Street

09/01/2020



Lane Group	EBL	EBT	EBR	WBL	WBT	WBR	NBL	NBT	NBR	SBL	SBT	SBR
Lane Configurations												
Traffic Volume (vph)	55	345	23	10	251	43	2	5	10	20	20	50
Future Volume (vph)	55	345	23	10	251	43	2	5	10	20	20	50
Ideal Flow (vphpl)	1900	1900	1900	1900	1900	1900	1900	1900	1900	1900	1900	1900
Lane Width (ft)	10	10	16	10	10	10	12	12	12	12	12	12
Grade (%)		2%			-2%			-4%				-3%
Storage Length (ft)	150		0	200		0	0		100	0		0
Storage Lanes	1		0	1		0	0		1	0		0
Taper Length (ft)	25			25			25			25		
Lane Util. Factor	1.00	1.00	1.00	1.00	1.00	1.00	1.00	1.00	1.00	1.00	1.00	1.00
Ped Bike Factor	0.95	0.99		0.95	0.98			0.98	0.94		0.94	
Frt		0.991			0.978				0.850		0.926	
Flt Protected	0.950			0.950				0.985			0.989	
Satd. Flow (prot)	1430	1480	0	1431	1450	0	0	1621	1399	0	1431	0
Flt Permitted	0.549			0.495				0.885			0.919	
Satd. Flow (perm)	786	1480	0	710	1450	0	0	1424	1316	0	1318	0
Right Turn on Red			No			No			No			No
Satd. Flow (RTOR)												
Link Speed (mph)		20			20			20			25	
Link Distance (ft)		993			298			285			379	
Travel Time (s)		33.9			10.2			9.7			10.3	
Confl. Peds. (#/hr)	39		57	57		39	57		29	29		57
Peak Hour Factor	0.84	0.84	0.84	0.83	0.83	0.83	0.53	0.53	0.53	0.92	0.92	0.92
Heavy Vehicles (%)	5%	5%	5%	7%	7%	7%	6%	6%	6%	5%	5%	5%
Adj. Flow (vph)	65	411	27	12	302	52	4	9	19	22	22	54
Shared Lane Traffic (%)												
Lane Group Flow (vph)	65	438	0	12	354	0	0	13	19	0	98	0
Turn Type	Perm	NA		Perm	NA		Perm	NA	Perm	Perm	NA	
Protected Phases		2			6			8				4
Permitted Phases	2			6			8		8	4		
Detector Phase	2	2		6	6		8	8	8	4	4	
Switch Phase												
Minimum Initial (s)	10.0	10.0		10.0	10.0		7.0	7.0	7.0	7.0	7.0	
Minimum Split (s)	22.0	22.0		19.0	19.0		29.0	29.0	29.0	27.0	27.0	
Total Split (s)	31.0	31.0		31.0	31.0		29.0	29.0	29.0	29.0	29.0	
Total Split (%)	51.7%	51.7%		51.7%	51.7%		48.3%	48.3%	48.3%	48.3%	48.3%	
Maximum Green (s)	25.4	25.4		25.4	25.4		22.7	22.7	22.7	23.0	23.0	
Yellow Time (s)	3.3	3.3		3.3	3.3		3.1	3.1	3.1	3.4	3.4	
All-Red Time (s)	2.3	2.3		2.3	2.3		3.2	3.2	3.2	2.6	2.6	
Lost Time Adjust (s)	-0.6	-0.6		-0.6	-0.6		-1.3	-1.3	-1.3	-1.0	-1.0	
Total Lost Time (s)	5.0	5.0		5.0	5.0		5.0	5.0	5.0	5.0	5.0	
Lead/Lag												
Lead-Lag Optimize?												
Vehicle Extension (s)	3.0	3.0		3.0	3.0		2.0	2.0	2.0	2.0	2.0	
Recall Mode	C-Max	C-Max		C-Max	C-Max		None	None	None	None	None	
Walk Time (s)	7.0	7.0		7.0	7.0		7.0	7.0	7.0	7.0	7.0	
Flash Dont Walk (s)	9.0	9.0		6.0	6.0		15.0	15.0	15.0	14.0	14.0	
Pedestrian Calls (#/hr)	0	0		0	0		0	0	0	0	0	
Act Effect Green (s)	43.3	43.3		43.3	43.3		10.4	10.4	10.4	10.3	10.3	

Lanes, Volumes, Timings

8: Carolina Square Driveway/Church Street & W. Franklin Street

09/01/2020



Lane Group	EBL	EBT	EBR	WBL	WBT	WBR	NBL	NBT	NBR	SBL	SBT	SBR
Actuated g/C Ratio	0.72	0.72		0.72	0.72			0.17	0.17			0.17
v/c Ratio	0.11	0.41		0.02	0.34			0.05	0.08			0.43
Control Delay	5.1	6.6		1.9	3.7			19.6	20.2			25.6
Queue Delay	0.0	0.0		0.0	0.0			0.0	0.0			0.0
Total Delay	5.1	6.6		1.9	3.7			19.6	20.2			25.6
LOS	A	A		A	A			B	C			C
Approach Delay		6.4			3.6			19.9				25.6
Approach LOS		A			A			B				C
Queue Length 50th (ft)	7	59		2	80			4	6			35
Queue Length 95th (ft)	22	124		m1	m28			9	11			57
Internal Link Dist (ft)		913			218			205				299
Turn Bay Length (ft)	150			200					100			
Base Capacity (vph)	567	1067		512	1045			569	526			527
Starvation Cap Reductn	0	0		0	0			0	0			0
Spillback Cap Reductn	0	0		0	0			0	0			0
Storage Cap Reductn	0	0		0	0			0	0			0
Reduced v/c Ratio	0.11	0.41		0.02	0.34			0.02	0.04			0.19

Intersection Summary

Area Type: CBD
 Cycle Length: 60
 Actuated Cycle Length: 60
 Offset: 42 (70%), Referenced to phase 2:EBTL and 6:WBTL, Start of Green
 Natural Cycle: 60
 Control Type: Actuated-Coordinated
 Maximum v/c Ratio: 0.43
 Intersection Signal Delay: 7.7 Intersection LOS: A
 Intersection Capacity Utilization 64.2% ICU Level of Service C
 Analysis Period (min) 15
 m Volume for 95th percentile queue is metered by upstream signal.

Splits and Phases: 8: Carolina Square Driveway/Church Street & W. Franklin Street

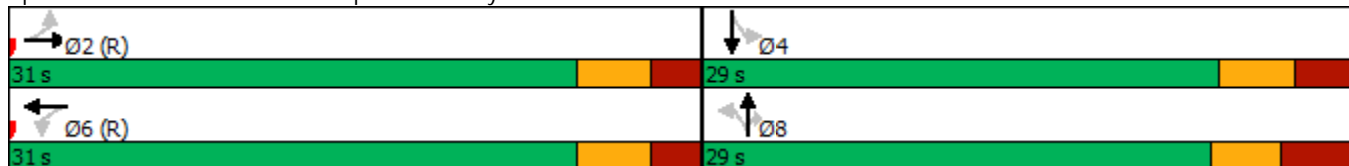

Lanes, Volumes, Timings

9: NC 86 (S. Columbia St)/NC 86 (N. Columbia St) & W. Franklin Street/E. Franklin Street 09/01/2020



Lane Group	EBL	EBT	EBR	WBL	WBT	WBR	NBL	NBT	NBR	SBL	SBT	SBR
Lane Configurations	↖	↗		↖	↗	↗	↖	↗		↖	↗	
Traffic Volume (vph)	77	286	29	66	278	46	30	344	88	36	468	81
Future Volume (vph)	77	286	29	66	278	46	30	344	88	36	468	81
Ideal Flow (vphpl)	1900	1900	1900	1900	1900	1900	1900	1900	1900	1900	1900	1900
Lane Width (ft)	9	12	13	10	10	13	9	10	10	9	9	11
Grade (%)		3%			1%			-2%			3%	
Storage Length (ft)	250		0	125		0	475		0	125		0
Storage Lanes	1		0	1		1	1		0	1		0
Taper Length (ft)	25			25			25			25		
Lane Util. Factor	1.00	0.95	0.95	1.00	1.00	1.00	1.00	0.95	0.95	1.00	0.95	0.95
Ped Bike Factor	0.87	0.99		0.95		0.79	0.97	0.97		0.92	0.99	
Frt		0.986				0.850		0.969			0.978	
Flt Protected	0.950			0.950			0.950			0.950		
Satd. Flow (prot)	1372	2980	0	1410	1484	1397	1342	2605	0	1346	2595	0
Flt Permitted	0.950			0.950			0.950			0.950		
Satd. Flow (perm)	1192	2980	0	1345	1484	1100	1299	2605	0	1233	2595	0
Right Turn on Red			No			No			No			No
Satd. Flow (RTOR)												
Link Speed (mph)		20			20			25			25	
Link Distance (ft)		457			941			981			353	
Travel Time (s)		15.6			32.1			26.8			9.6	
Confl. Peds. (#/hr)	125		49	49		125	29		98	98		29
Peak Hour Factor	0.80	0.80	0.80	0.87	0.87	0.87	0.93	0.93	0.93	0.85	0.85	0.85
Heavy Vehicles (%)	5%	5%	5%	7%	7%	7%	10%	10%	10%	7%	7%	7%
Adj. Flow (vph)	96	358	36	76	320	53	32	370	95	42	551	95
Shared Lane Traffic (%)												
Lane Group Flow (vph)	96	394	0	76	320	53	32	465	0	42	646	0
Turn Type	Prot	NA		Prot	NA	pm+ov	Prot	NA		Prot	NA	
Protected Phases	5	2		1	6	7	3	8		7	4	
Permitted Phases						6						
Detector Phase	5	2		1	6	7	3	8		7	4	
Switch Phase												
Minimum Initial (s)	7.0	10.0		7.0	10.0	7.0	7.0	7.0		7.0	7.0	
Minimum Split (s)	15.0	28.2		15.0	28.2	15.0	15.0	28.0		15.0	28.1	
Total Split (s)	22.0	38.0		22.0	38.0	22.0	22.0	38.0		22.0	38.0	
Total Split (%)	18.3%	31.7%		18.3%	31.7%	18.3%	18.3%	31.7%		18.3%	31.7%	
Maximum Green (s)	16.6	31.8		16.1	31.8	16.1	16.1	32.1		16.1	32.3	
Yellow Time (s)	3.0	3.0		3.0	3.0	3.0	3.0	3.3		3.0	3.1	
All-Red Time (s)	2.4	3.2		2.9	3.2	2.9	2.9	2.6		2.9	2.6	
Lost Time Adjust (s)	-0.4	-1.2		-0.9	-1.2	-2.0	-0.9	-0.9		-0.9	-0.7	
Total Lost Time (s)	5.0	5.0		5.0	5.0	3.9	5.0	5.0		5.0	5.0	
Lead/Lag	Lead	Lag		Lead	Lag	Lead	Lead	Lag		Lead	Lag	
Lead-Lag Optimize?												
Vehicle Extension (s)	1.0	3.0		1.0	3.0	1.0	1.0	2.0		1.0	2.0	
Recall Mode	None	C-Max		None	C-Max	None	None	Ped		None	Ped	
Walk Time (s)		7.0			7.0			7.0			7.0	
Flash Dont Walk (s)		15.0			15.0			15.0			15.0	
Pedestrian Calls (#/hr)		0			0			0			0	
Act Effect Green (s)	12.2	52.2		11.2	48.6	60.0	8.6	32.6		9.2	35.7	

Lanes, Volumes, Timings

9: NC 86 (S. Columbia St)/NC 86 (N. Columbia St) & W. Franklin Street/E. Franklin Street 09/01/2020



Lane Group	EBL	EBT	EBR	WBL	WBT	WBR	NBL	NBT	NBR	SBL	SBT	SBR
Actuated g/C Ratio	0.10	0.44		0.09	0.40	0.50	0.07	0.27		0.08	0.30	
v/c Ratio	0.69	0.30		0.58	0.53	0.09	0.33	0.66		0.41	0.84	
Control Delay	80.1	24.0		78.9	23.7	9.3	83.6	20.9		92.6	26.5	
Queue Delay	0.0	0.0		0.0	0.0	0.0	0.0	0.0		0.0	0.1	
Total Delay	80.1	24.0		78.9	23.7	9.3	83.6	20.9		92.6	26.6	
LOS	F	C		E	C	A	F	C		F	C	
Approach Delay		35.0			31.3			24.9			30.7	
Approach LOS		D			C			C			C	
Queue Length 50th (ft)	76	96		62	95	11	18	174		31	177	
Queue Length 95th (ft)	120	140		111	#173	19	m42	154		70	79	
Internal Link Dist (ft)		377			861			901			273	
Turn Bay Length (ft)	250			125			475			125		
Base Capacity (vph)	194	1295		199	601	666	190	766		190	791	
Starvation Cap Reductn	0	0		0	0	0	0	0		0	6	
Spillback Cap Reductn	0	0		0	0	0	0	0		0	0	
Storage Cap Reductn	0	0		0	0	0	0	0		0	0	
Reduced v/c Ratio	0.49	0.30		0.38	0.53	0.08	0.17	0.61		0.22	0.82	

Intersection Summary

Area Type: CBD
 Cycle Length: 120
 Actuated Cycle Length: 120
 Offset: 0 (0%), Referenced to phase 2:EBT and 6:WBT, Start of Green
 Natural Cycle: 90
 Control Type: Actuated-Coordinated
 Maximum v/c Ratio: 0.84
 Intersection Signal Delay: 30.5 Intersection LOS: C
 Intersection Capacity Utilization 65.0% ICU Level of Service C
 Analysis Period (min) 15
 # 95th percentile volume exceeds capacity, queue may be longer.
 Queue shown is maximum after two cycles.
 m Volume for 95th percentile queue is metered by upstream signal.

Splits and Phases: 9: NC 86 (S. Columbia St)/NC 86 (N. Columbia St) & W. Franklin Street/E. Franklin Street

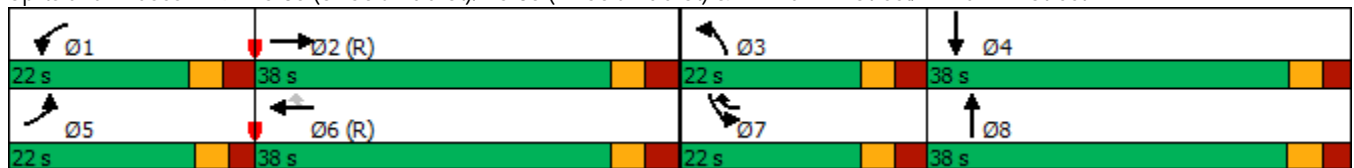

Lanes, Volumes, Timings

10: E. Franklin Street & Henderson Street

09/01/2020

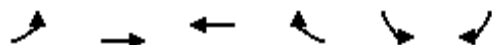

Lane Group	EBL	EBT	WBT	WBR	SBL	SBR
Lane Configurations		↕↕	↕↔		↔↕	
Traffic Volume (vph)	15	370	388	87	68	17
Future Volume (vph)	15	370	388	87	68	17
Ideal Flow (vphpl)	1900	1900	1900	1900	1900	1900
Lane Width (ft)	10	13	10	10	11	11
Grade (%)		-2%	2%		3%	
Lane Util. Factor	0.95	0.95	0.95	0.95	1.00	1.00
Ped Bike Factor		1.00	0.99		0.95	
Frt			0.972		0.972	
Flt Protected		0.998			0.962	
Satd. Flow (prot)	0	3223	2743	0	1436	0
Flt Permitted		0.932			0.962	
Satd. Flow (perm)	0	3007	2743	0	1389	0
Right Turn on Red				No		No
Satd. Flow (RTOR)						
Link Speed (mph)		20	20		20	
Link Distance (ft)		941	1200		366	
Travel Time (s)		32.1	40.9		12.5	
Confl. Peds. (#/hr)	26			26	44	87
Peak Hour Factor	0.91	0.91	0.90	0.90	0.79	0.79
Heavy Vehicles (%)	5%	5%	5%	5%	4%	4%
Parking (#/hr)						0
Adj. Flow (vph)	16	407	431	97	86	22
Shared Lane Traffic (%)						
Lane Group Flow (vph)	0	423	528	0	108	0
Turn Type	Perm	NA	NA		Prot	
Protected Phases		2	6		4	
Permitted Phases	2					
Detector Phase	2	2	6		4	
Switch Phase						
Minimum Initial (s)	10.0	10.0	10.0		7.0	
Minimum Split (s)	17.0	17.0	22.0		25.0	
Total Split (s)	32.0	32.0	32.0		28.0	
Total Split (%)	53.3%	53.3%	53.3%		46.7%	
Maximum Green (s)	25.8	25.8	25.9		22.9	
Yellow Time (s)	3.0	3.0	3.0		3.0	
All-Red Time (s)	3.2	3.2	3.1		2.1	
Lost Time Adjust (s)		-1.2	-1.1		-0.1	
Total Lost Time (s)		5.0	5.0		5.0	
Lead/Lag						
Lead-Lag Optimize?						
Vehicle Extension (s)	2.0	2.0	2.0		1.0	
Recall Mode	C-Max	C-Max	C-Max		None	
Walk Time (s)			7.0		7.0	
Flash Dont Walk (s)			8.0		12.0	
Pedestrian Calls (#/hr)			0		0	
Act Effct Green (s)		44.5	44.5		8.9	
Actuated g/C Ratio		0.74	0.74		0.15	
v/c Ratio		0.19	0.26		0.51	

Lanes, Volumes, Timings
 10: E. Franklin Street & Henderson Street

09/01/2020



Lane Group	EBL	EBT	WBT	WBR	SBL	SBR
Control Delay		6.8	3.9		29.4	
Queue Delay		0.0	0.0		0.0	
Total Delay		6.8	3.9		29.4	
LOS		A	A		C	
Approach Delay		6.8	3.9		29.4	
Approach LOS		A	A		C	
Queue Length 50th (ft)		108	125		33	
Queue Length 95th (ft)		154	19		55	
Internal Link Dist (ft)		861	1120		286	
Turn Bay Length (ft)						
Base Capacity (vph)		2229	2033		550	
Starvation Cap Reductn		0	0		0	
Spillback Cap Reductn		0	0		0	
Storage Cap Reductn		0	0		0	
Reduced v/c Ratio		0.19	0.26		0.20	

Intersection Summary

Area Type:	CBD
Cycle Length:	60
Actuated Cycle Length:	60
Offset:	53 (88%), Referenced to phase 2:EBTL and 6:WBT, Start of Green
Natural Cycle:	50
Control Type:	Actuated-Coordinated
Maximum v/c Ratio:	0.51
Intersection Signal Delay:	7.7
Intersection LOS:	A
Intersection Capacity Utilization:	47.2%
ICU Level of Service:	A
Analysis Period (min):	15

Splits and Phases: 10: E. Franklin Street & Henderson Street

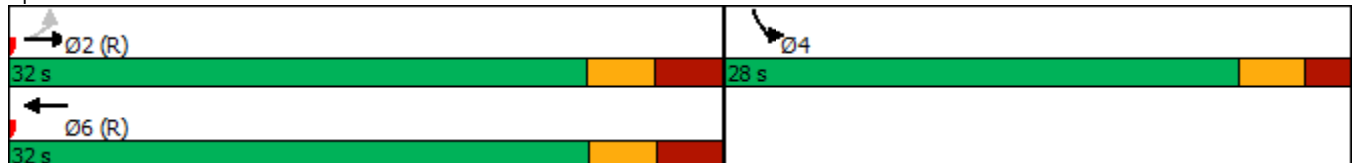

Lanes, Volumes, Timings

11: Raleigh Street/Hillsborough Street & E. Franklin Street

09/01/2020



Lane Group	EBL	EBT	EBR	WBL	WBT	WBR	NBL	NBT	NBR	SBL	SBT	SBR
Lane Configurations												
Traffic Volume (vph)	19	317	105	42	432	97	85	180	23	70	340	18
Future Volume (vph)	19	317	105	42	432	97	85	180	23	70	340	18
Ideal Flow (vphpl)	1900	1900	1900	1900	1900	1900	1900	1900	1900	1900	1900	1900
Lane Width (ft)	9	9	10	9	10	11	12	12	12	10	10	10
Grade (%)		1%			-2%			1%			1%	
Storage Length (ft)	75		0	75		0	0		0	100		0
Storage Lanes	1		0	1		0	0		0	1		0
Taper Length (ft)	25			25			25			25		
Lane Util. Factor	1.00	0.95	0.95	1.00	0.95	0.95	1.00	1.00	1.00	1.00	1.00	1.00
Ped Bike Factor	0.99	0.99		0.99	0.99			0.99		0.99	1.00	
Frt		0.963			0.973			0.989			0.992	
Flt Protected	0.950			0.950				0.986		0.950		
Satd. Flow (prot)	1539	2934	0	1578	3165	0	0	1768	0	1627	1695	0
Flt Permitted	0.375			0.425				0.650		0.504		
Satd. Flow (perm)	605	2934	0	698	3165	0	0	1161	0	856	1695	0
Right Turn on Red			No			No			No			No
Satd. Flow (RTOR)												
Link Speed (mph)		20			30			25			25	
Link Distance (ft)		1200			1013			995			363	
Travel Time (s)		40.9			23.0			27.1			9.9	
Confl. Peds. (#/hr)	9		16	16		9	25		11	11		25
Peak Hour Factor	0.86	0.86	0.86	0.92	0.92	0.92	0.83	0.83	0.83	0.96	0.96	0.96
Heavy Vehicles (%)	5%	5%	5%	4%	4%	4%	4%	4%	4%	3%	3%	3%
Adj. Flow (vph)	22	369	122	46	470	105	102	217	28	73	354	19
Shared Lane Traffic (%)												
Lane Group Flow (vph)	22	491	0	46	575	0	0	347	0	73	373	0
Turn Type	Perm	NA		Perm	NA		pm+pt	NA		D.Pm	NA	
Protected Phases		2			6		7	4				8
Permitted Phases	2			6			4			4		
Detector Phase	2	2		6	6		7	4		4		8
Switch Phase												
Minimum Initial (s)	10.0	10.0		10.0	10.0		7.0	7.0		7.0	7.0	
Minimum Split (s)	16.0	16.0		16.0	16.0		14.0	30.0		30.0	29.0	
Total Split (s)	47.0	47.0		47.0	47.0		28.0	73.0		73.0	45.0	
Total Split (%)	39.2%	39.2%		39.2%	39.2%		23.3%	60.8%		60.8%	37.5%	
Maximum Green (s)	41.7	41.7		41.7	41.7		21.8	66.6		66.6	38.6	
Yellow Time (s)	3.0	3.0		3.0	3.0		3.0	3.1		3.1	3.1	
All-Red Time (s)	2.3	2.3		2.3	2.3		3.2	3.3		3.3	3.3	
Lost Time Adjust (s)	-0.3	-0.3		-0.3	-0.3			-1.4		-1.4	-1.4	
Total Lost Time (s)	5.0	5.0		5.0	5.0			5.0		5.0	5.0	
Lead/Lag							Lead				Lag	
Lead-Lag Optimize?												
Vehicle Extension (s)	3.0	3.0		3.0	3.0		3.0	2.0		2.0	2.0	
Recall Mode	C-Max	C-Max		C-Max	C-Max		None	None		None	None	
Walk Time (s)								7.0		7.0	7.0	
Flash Dont Walk (s)								16.0		16.0	15.0	
Pedestrian Calls (#/hr)								0		0	0	
Act Effect Green (s)	56.4	56.4		56.4	56.4			53.6		53.6	53.6	

Lanes, Volumes, Timings

11: Raleigh Street/Hillsborough Street & E. Franklin Street

09/01/2020



Lane Group	EBL	EBT	EBR	WBL	WBT	WBR	NBL	NBT	NBR	SBL	SBT	SBR
Actuated g/C Ratio	0.47	0.47		0.47	0.47			0.45		0.45	0.45	
v/c Ratio	0.08	0.36		0.14	0.39			0.67		0.19	0.49	
Control Delay	15.5	14.8		24.9	24.0			31.5		15.4	21.5	
Queue Delay	0.0	0.0		0.0	0.0			0.0		0.0	2.1	
Total Delay	15.5	14.8		24.9	24.0			31.5		15.4	23.5	
LOS	B	B		C	C			C		B	C	
Approach Delay		14.9			24.0			31.5			22.2	
Approach LOS		B			C			C			C	
Queue Length 50th (ft)	6	72		20	152			203		32	189	
Queue Length 95th (ft)	15	88		56	242			216		53	225	
Internal Link Dist (ft)		1120			933			915			283	
Turn Bay Length (ft)	75			75						100		
Base Capacity (vph)	284	1379		328	1488			657		485	769	
Starvation Cap Reductn	0	0		0	0			0		0	256	
Spillback Cap Reductn	0	0		0	0			0		0	0	
Storage Cap Reductn	0	0		0	0			0		0	0	
Reduced v/c Ratio	0.08	0.36		0.14	0.39			0.53		0.15	0.73	

Intersection Summary





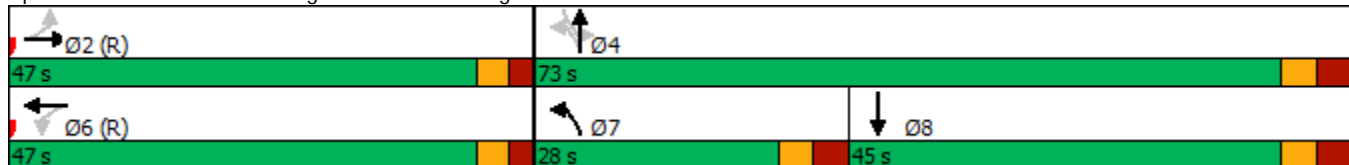













Area Type:	Other
Cycle Length:	120
Actuated Cycle Length:	120
Offset:	61 (51%), Referenced to phase 2:EBTL and 6:WBTL, Start of Green
Natural Cycle:	60
Control Type:	Actuated-Coordinated
Maximum v/c Ratio:	0.67
Intersection Signal Delay:	22.5
Intersection LOS:	C
Intersection Capacity Utilization	76.0%
ICU Level of Service	D
Analysis Period (min)	15

Splits and Phases: 11: Raleigh Street/Hillsborough Street & E. Franklin Street



Lanes, Volumes, Timings

13: NC 86 (N. Columbia St)/NC 86 (MLK Jr. Blvd) & North Street & N. Columbia Street 09/01/2020

												
Lane Group	WBL	WBR	WBR2	NBL	NBT	NBR	SBL	SBT	SBR	SEL2	SEL	SER
Lane Configurations												
Traffic Volume (vph)	2	3	20	38	441	3	77	765	2	2	6	55
Future Volume (vph)	2	3	20	38	441	3	77	765	2	2	6	55
Ideal Flow (vphpl)	1900	1900	1900	1900	1900	1900	1900	1900	1900	1900	1900	1900
Grade (%)	2%				-5%			5%			-3%	
Storage Length (ft)	0	0		150		0	70		0		0	0
Storage Lanes	1	0		1		0	1		0		1	0
Taper Length (ft)	25			25			25				25	
Lane Util. Factor	1.00	1.00	1.00	1.00	0.95	0.95	1.00	0.95	0.95	1.00	1.00	1.00
Ped Bike Factor				1.00	1.00		0.99	1.00				
Frt	0.875				0.999							0.883
Flt Protected	0.996			0.950			0.950				0.993	
Satd. Flow (prot)	1490	0	0	1729	3454	0	1676	3352	0	0	1566	0
Flt Permitted	0.996			0.298			0.473				0.993	
Satd. Flow (perm)	1490	0	0	542	3454	0	829	3352	0	0	1566	0
Right Turn on Red			No			No			No			No
Satd. Flow (RTOR)												
Link Speed (mph)	20				35			35				25
Link Distance (ft)	263				476			2108				715
Travel Time (s)	9.0				9.3			41.1				19.5
Confl. Peds. (#/hr)				1		15	15		1			
Peak Hour Factor	0.48	0.48	0.48	0.93	0.93	0.93	0.89	0.89	0.89	0.76	0.76	0.76
Heavy Vehicles (%)	10%	10%	10%	7%	7%	7%	5%	5%	5%	8%	8%	8%
Adj. Flow (vph)	4	6	42	41	474	3	87	860	2	3	8	72
Shared Lane Traffic (%)												
Lane Group Flow (vph)	52	0	0	41	477	0	87	862	0	0	83	0
Turn Type	Prot			Perm	NA		Perm	NA		Prot	Prot	
Protected Phases	3				2			6		4	4	
Permitted Phases				2			6					
Detector Phase	3			2	2		6	6		4	4	
Switch Phase												
Minimum Initial (s)	7.0			10.0	10.0		10.0	10.0		7.0	7.0	
Minimum Split (s)	14.0			17.0	17.0		17.0	17.0		14.0	14.0	
Total Split (s)	23.0			70.0	70.0		70.0	70.0		27.0	27.0	
Total Split (%)	19.2%			58.3%	58.3%		58.3%	58.3%		22.5%	22.5%	
Maximum Green (s)	16.0			63.0	63.0		63.0	63.0		20.0	20.0	
Yellow Time (s)	5.0			5.0	5.0		5.0	5.0		5.0	5.0	
All-Red Time (s)	2.0			2.0	2.0		2.0	2.0		2.0	2.0	
Lost Time Adjust (s)	-2.0			-2.0	-2.0		-2.0	-2.0			-2.0	
Total Lost Time (s)	5.0			5.0	5.0		5.0	5.0			5.0	
Lead/Lag	Lead									Lag	Lag	
Lead-Lag Optimize?	Yes									Yes	Yes	
Vehicle Extension (s)	3.0			3.0	3.0		3.0	3.0		3.0	3.0	
Recall Mode	None			C-Max	C-Max		C-Max	C-Max		None	None	
Act Effct Green (s)	11.8			86.1	86.1		86.1	86.1			13.7	
Actuated g/C Ratio	0.10			0.72	0.72		0.72	0.72			0.11	
v/c Ratio	0.36			0.11	0.19		0.15	0.36			0.47	
Control Delay	56.5			4.5	3.4		9.6	9.6			57.4	
Queue Delay	0.0			0.0	0.0		0.0	0.0			0.0	

Lanes, Volumes, Timings

14: NC 86 (MLK Jr. Blvd) & Longview Street/Mill Creek Apts Driveway

09/01/2020



Lane Group	EBL	EBT	EBR	WBL	WBT	WBR	NBL	NBT	NBR	SBL	SBT	SBR
Lane Configurations		↕			↕		↕	↕↔		↕	↕↔	
Traffic Volume (vph)	78	0	10	6	0	5	2	439	5	0	755	67
Future Volume (vph)	78	0	10	6	0	5	2	439	5	0	755	67
Ideal Flow (vphpl)	1900	1900	1900	1900	1900	1900	1900	1900	1900	1900	1900	1900
Grade (%)		-6%			1%			2%			-4%	
Storage Length (ft)	0		0	0		0	225		0	250		0
Storage Lanes	0		0	0		0	1		0	1		0
Taper Length (ft)	25			25			25			25		
Lane Util. Factor	1.00	1.00	1.00	1.00	1.00	1.00	1.00	0.95	0.95	1.00	0.95	0.95
Ped Bike Factor		1.00			0.99		1.00	1.00			1.00	
Frt		0.985			0.944			0.998			0.988	
Flt Protected		0.958			0.972		0.950					
Satd. Flow (prot)	0	1737	0	0	1701	0	1686	3364	0	1846	3456	0
Flt Permitted		0.741			0.817		0.246					
Satd. Flow (perm)	0	1343	0	0	1420	0	436	3364	0	1846	3456	0
Right Turn on Red			No			No			No			No
Satd. Flow (RTOR)												
Link Speed (mph)		25			20			35			35	
Link Distance (ft)		451			338			2108			784	
Travel Time (s)		12.3			11.5			41.1			15.3	
Confl. Peds. (#/hr)			16	16			4		4	4		4
Peak Hour Factor	0.52	0.52	0.52	0.92	0.92	0.92	0.93	0.93	0.93	0.84	0.84	0.84
Heavy Vehicles (%)	6%	6%	6%	2%	2%	2%	6%	6%	6%	5%	5%	5%
Adj. Flow (vph)	150	0	19	7	0	5	2	472	5	0	899	80
Shared Lane Traffic (%)												
Lane Group Flow (vph)	0	169	0	0	12	0	2	477	0	0	979	0
Turn Type	Perm	NA		Perm	NA		Perm	NA		Perm	NA	
Protected Phases		4			8			2			6	
Permitted Phases	4			8			2			6		
Detector Phase	4	4		8	8		2	2		6	6	
Switch Phase												
Minimum Initial (s)	7.0	7.0		7.0	7.0		12.0	12.0		12.0	12.0	
Minimum Split (s)	31.0	31.0		14.0	14.0		28.0	28.0		28.0	28.0	
Total Split (s)	20.0	20.0		20.0	20.0		60.0	60.0		60.0	60.0	
Total Split (%)	25.0%	25.0%		25.0%	25.0%		75.0%	75.0%		75.0%	75.0%	
Maximum Green (s)	14.0	14.0		13.9	13.9		54.0	54.0		54.5	54.5	
Yellow Time (s)	3.5	3.5		3.0	3.0		4.5	4.5		4.0	4.0	
All-Red Time (s)	2.5	2.5		3.1	3.1		1.5	1.5		1.5	1.5	
Lost Time Adjust (s)		-1.0			-1.0		-1.0	-1.0		-0.5	-0.5	
Total Lost Time (s)		5.0			5.1		5.0	5.0		5.0	5.0	
Lead/Lag												
Lead-Lag Optimize?												
Vehicle Extension (s)	3.0	3.0		3.0	3.0		3.0	3.0		3.0	3.0	
Recall Mode	None	None		None	None		Min	Min		Min	Min	
Walk Time (s)	7.0	7.0					7.0	7.0		7.0	7.0	
Flash Dont Walk (s)	17.0	17.0					9.0	9.0		9.0	9.0	
Pedestrian Calls (#/hr)	0	0					0	0		0	0	
Act Effct Green (s)		12.0			11.9		23.8	23.8			23.8	
Actuated g/C Ratio		0.26			0.26		0.52	0.52			0.52	

Lanes, Volumes, Timings

14: NC 86 (MLK Jr. Blvd) & Longview Street/Mill Creek Apts Driveway

09/01/2020



Lane Group	EBL	EBT	EBR	WBL	WBT	WBR	NBL	NBT	NBR	SBL	SBT	SBR
v/c Ratio		0.48			0.03		0.01	0.27				0.55
Control Delay		19.5			13.3		6.0	7.1				9.2
Queue Delay		0.0			0.0		0.0	0.0				0.0
Total Delay		19.5			13.3		6.0	7.1				9.2
LOS		B			B		A	A				A
Approach Delay		19.5			13.3			7.0				9.2
Approach LOS		B			B			A				A
Queue Length 50th (ft)		34			2		0	32				79
Queue Length 95th (ft)		46			12		3	61				124
Internal Link Dist (ft)		371			258			2028				704
Turn Bay Length (ft)							225					
Base Capacity (vph)		444			466		436	3364				3456
Starvation Cap Reductn		0			0		0	0				0
Spillback Cap Reductn		0			0		0	0				0
Storage Cap Reductn		0			0		0	0				0
Reduced v/c Ratio		0.38			0.03		0.00	0.14				0.28

Intersection Summary

Area Type:	Other
Cycle Length:	80
Actuated Cycle Length:	45.9
Natural Cycle:	60
Control Type:	Actuated-Uncoordinated
Maximum v/c Ratio:	0.55
Intersection Signal Delay:	9.7
Intersection LOS:	A
Intersection Capacity Utilization:	44.2%
ICU Level of Service:	A
Analysis Period (min):	15

Splits and Phases: 14: NC 86 (MLK Jr. Blvd) & Longview Street/Mill Creek Apts Driveway



Lanes, Volumes, Timings
 15: NC 86 (Pittsboro St) & W. Cameron Avenue

09/01/2020

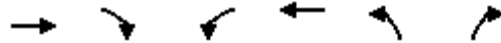

Lane Group	EBT	EBR	WBL	WBT	NBL	NBR	Ø1	Ø4
Lane Configurations	↻		↻↻	↻				
Traffic Volume (vph)	120	161	610	135	0	0		
Future Volume (vph)	120	161	610	135	0	0		
Ideal Flow (vphpl)	1900	1900	1900	1900	1900	1900		
Lane Width (ft)	12	12	11	12	12	12		
Grade (%)	3%			-3%	0%			
Storage Length (ft)		0	75		0	0		
Storage Lanes		0	0		0	0		
Taper Length (ft)			25		25			
Lane Util. Factor	1.00	1.00	0.97	1.00	1.00	1.00		
Ped Bike Factor	0.94		0.90					
Frt	0.923							
Flt Protected			0.950					
Satd. Flow (prot)	1434	0	2837	1592	0	0		
Flt Permitted			0.950					
Satd. Flow (perm)	1434	0	2565	1592	0	0		
Right Turn on Red		No				No		
Satd. Flow (RTOR)								
Link Speed (mph)	25			25	25			
Link Distance (ft)	391			120	794			
Travel Time (s)	30.0			10.7	21.7			
Confl. Peds. (#/hr)		57	57					
Peak Hour Factor	0.81	0.81	0.87	0.87	0.90	0.90		
Heavy Vehicles (%)	2%	2%	9%	9%	2%	2%		
Adj. Flow (vph)	148	199	701	155	0	0		
Shared Lane Traffic (%)								
Lane Group Flow (vph)	347	0	701	155	0	0		
Turn Type	NA		Prot	NA				
Protected Phases	2		1 4	6			1	4
Permitted Phases								
Detector Phase	2		1 4	6				
Switch Phase								
Minimum Initial (s)	10.0			10.0			7.0	7.0
Minimum Split (s)	17.0			15.0			13.0	20.0
Total Split (s)	25.0			40.0			15.0	20.0
Total Split (%)	41.7%			66.7%			25%	33%
Maximum Green (s)	19.9			35.0			9.9	16.0
Yellow Time (s)	3.0			3.3			3.0	3.0
All-Red Time (s)	2.1			1.7			2.1	1.0
Lost Time Adjust (s)	-0.1			0.0				
Total Lost Time (s)	5.0			5.0				
Lead/Lag	Lag						Lead	
Lead-Lag Optimize?								
Vehicle Extension (s)	1.0			1.0			4.0	0.2
Recall Mode	None			C-Max			C-Max	None
Walk Time (s)	7.0							7.0
Flash Dont Walk (s)	4.0							9.0
Pedestrian Calls (#/hr)	0							0
Act Effect Green (s)	20.0		30.0	38.6				

Lanes, Volumes, Timings
 15: NC 86 (Pittsboro St) & W. Cameron Avenue

09/01/2020



Lane Group	EBT	EBR	WBL	WBT	NBL	NBR	Ø1	Ø4
Actuated g/C Ratio	0.33		0.50	0.64				
v/c Ratio	0.73		0.49	0.15				
Control Delay	28.7		14.4	6.1				
Queue Delay	0.0		0.0	0.0				
Total Delay	28.7		14.4	6.1				
LOS	C		B	A				
Approach Delay	28.7			12.9				
Approach LOS	C			B				
Queue Length 50th (ft)	108		194	32				
Queue Length 95th (ft)	167		186	m83				
Internal Link Dist (ft)	311			40	714			
Turn Bay Length (ft)			75					
Base Capacity (vph)	478		1370	1025				
Starvation Cap Reductn	0		0	0				
Spillback Cap Reductn	0		0	0				
Storage Cap Reductn	0		0	0				
Reduced v/c Ratio	0.73		0.51	0.15				

Intersection Summary

Area Type: CBD
 Cycle Length: 60
 Actuated Cycle Length: 60
 Offset: 23 (38%), Referenced to phase 1:WBL and 6:WBT, Start of Green
 Natural Cycle: 60
 Control Type: Actuated-Coordinated
 Maximum v/c Ratio: 0.73
 Intersection Signal Delay: 17.5 Intersection LOS: B
 Intersection Capacity Utilization 48.1% ICU Level of Service A
 Analysis Period (min) 15
 m Volume for 95th percentile queue is metered by upstream signal.

Splits and Phases: 15: NC 86 (Pittsboro St) & W. Cameron Avenue

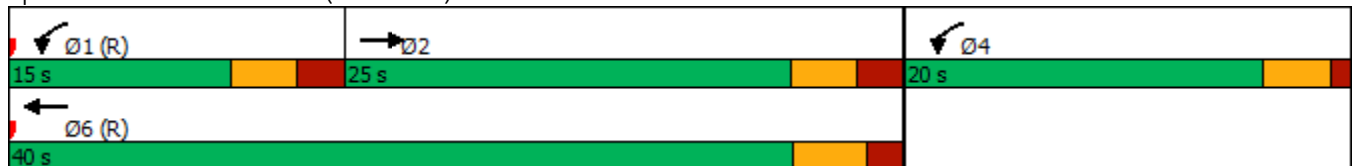

Lanes, Volumes, Timings

16: NC 86 (S. Columbia St) & W. Cameron Avenue/E. Cameron Avenue

09/01/2020



Lane Group	EBL	EBT	EBR	WBL	WBT	WBR	NBL	NBT	NBR	SBL	SBT	SBR
Lane Configurations												
Traffic Volume (vph)	18	92	0	0	96	20	99	417	43	67	0	546
Future Volume (vph)	18	92	0	0	96	20	99	417	43	67	0	546
Ideal Flow (vphpl)	1900	1900	1900	1900	1900	1900	1900	1900	1900	1900	1900	1900
Lane Width (ft)	11	12	12	12	12	12	10	10	10	11	11	12
Grade (%)		1%			-1%			1%			2%	
Storage Length (ft)	100		0	0		0	0		0	310		0
Storage Lanes	1		0	0		0	1		0	1		2
Taper Length (ft)	25			25			25			25		
Lane Util. Factor	1.00	1.00	1.00	1.00	1.00	1.00	0.91	0.91	0.95	1.00	1.00	0.88
Ped Bike Factor	0.95				0.99		0.79	0.95		0.76		0.77
Frt					0.977			0.986				0.850
Flt Protected	0.950						0.950	0.999		0.950		
Satd. Flow (prot)	1532	1668	0	0	1565	0	1248	2466	0	1413	0	2302
Flt Permitted	0.517						0.950	0.999		0.950		
Satd. Flow (perm)	796	1668	0	0	1565	0	982	2454	0	1078	0	1776
Right Turn on Red			No			No			No			No
Satd. Flow (RTOR)												
Link Speed (mph)		25			25			25				25
Link Distance (ft)		273			989			826				981
Travel Time (s)		10.7			57.6			22.5				26.8
Confl. Peds. (#/hr)	39		102	102		39	71		107	107		71
Peak Hour Factor	0.79	0.79	0.79	0.83	0.83	0.83	0.86	0.86	0.86	0.89	0.89	0.89
Heavy Vehicles (%)	2%	2%	2%	6%	6%	6%	10%	10%	10%	10%	10%	10%
Adj. Flow (vph)	23	116	0	0	116	24	115	485	50	75	0	613
Shared Lane Traffic (%)							10%					
Lane Group Flow (vph)	23	116	0	0	140	0	103	547	0	75	0	613
Turn Type	Perm	NA			NA		Split	NA		Prot		Prot
Protected Phases		4			8		2	2		1		1
Permitted Phases	4									1		1
Detector Phase	4	4			8		2	2		1		1
Switch Phase												
Minimum Initial (s)	10.0	10.0			10.0		7.0	7.0		7.0		7.0
Minimum Split (s)	24.0	24.0			31.0		18.0	18.0		26.0		26.0
Total Split (s)	34.0	34.0			34.0		22.0	22.0		36.0		36.0
Total Split (%)	28.3%	28.3%			28.3%		18.3%	18.3%		30.0%		30.0%
Maximum Green (s)	27.8	27.8			27.8		16.1	16.1		30.4		30.4
Yellow Time (s)	3.2	3.2			3.2		3.1	3.1		3.0		3.0
All-Red Time (s)	3.0	3.0			3.0		2.8	2.8		2.6		2.6
Lost Time Adjust (s)	-1.2	-1.2			-1.2		-0.9	-0.9		-0.6		-0.6
Total Lost Time (s)	5.0	5.0			5.0		5.0	5.0		5.0		5.0
Lead/Lag							Lag	Lag		Lead		Lead
Lead-Lag Optimize?							Yes	Yes		Yes		Yes
Vehicle Extension (s)	2.0	2.0			2.0		4.0	4.0		4.0		4.0
Recall Mode	None	None			None		C-Max	C-Max		None		None
Walk Time (s)	7.0	7.0			7.0		7.0	7.0		7.0		7.0
Flash Dont Walk (s)	10.0	10.0			17.0		5.0	5.0		13.0		13.0
Pedestrian Calls (#/hr)	0	0			0		0	0		0		0
Act Effect Green (s)	16.5	16.5			16.5		45.7	45.7		42.8		42.8

Lanes, Volumes, Timings

16: NC 86 (S. Columbia St) & W. Cameron Avenue/E. Cameron Avenue

09/01/2020

Lane Group	Ø9
Lane Configurations	
Traffic Volume (vph)	
Future Volume (vph)	
Ideal Flow (vphpl)	
Lane Width (ft)	
Grade (%)	
Storage Length (ft)	
Storage Lanes	
Taper Length (ft)	
Lane Util. Factor	
Ped Bike Factor	
Flt	
Flt Protected	
Satd. Flow (prot)	
Flt Permitted	
Satd. Flow (perm)	
Right Turn on Red	
Satd. Flow (RTOR)	
Link Speed (mph)	
Link Distance (ft)	
Travel Time (s)	
Confl. Peds. (#/hr)	
Peak Hour Factor	
Heavy Vehicles (%)	
Adj. Flow (vph)	
Shared Lane Traffic (%)	
Lane Group Flow (vph)	
Turn Type	
Protected Phases	9
Permitted Phases	
Detector Phase	
Switch Phase	
Minimum Initial (s)	7.0
Minimum Split (s)	28.0
Total Split (s)	28.0
Total Split (%)	23%
Maximum Green (s)	24.0
Yellow Time (s)	3.0
All-Red Time (s)	1.0
Lost Time Adjust (s)	
Total Lost Time (s)	
Lead/Lag	
Lead-Lag Optimize?	
Vehicle Extension (s)	0.2
Recall Mode	None
Walk Time (s)	7.0
Flash Dont Walk (s)	17.0
Pedestrian Calls (#/hr)	0
Act Effect Green (s)	

Lanes, Volumes, Timings

16: NC 86 (S. Columbia St) & W. Cameron Avenue/E. Cameron Avenue

09/01/2020



Lane Group	EBL	EBT	EBR	WBL	WBT	WBR	NBL	NBT	NBR	SBL	SBT	SBR
Actuated g/C Ratio	0.14	0.14			0.14		0.38	0.38		0.36		0.36
v/c Ratio	0.21	0.51			0.65		0.22	0.58		0.15		0.75
Control Delay	36.3	41.0			62.5		28.5	33.9		7.0		16.6
Queue Delay	0.0	0.0			0.0		0.0	0.0		0.0		0.0
Total Delay	36.3	41.0			62.5		28.5	33.9		7.0		16.6
LOS	D	D			E		C	C		A		B
Approach Delay		40.2			62.5			33.0			15.5	
Approach LOS		D			E			C			B	
Queue Length 50th (ft)	13	82			104		58	181		5		87
Queue Length 95th (ft)	m17	m108			150		112	257		m16		302
Internal Link Dist (ft)		193			909			746			901	
Turn Bay Length (ft)	100									310		
Base Capacity (vph)	192	403			378		475	938		503		820
Starvation Cap Reductn	0	0			0		0	0		0		0
Spillback Cap Reductn	0	0			0		0	0		0		0
Storage Cap Reductn	0	0			0		0	0		0		0
Reduced v/c Ratio	0.12	0.29			0.37		0.22	0.58		0.15		0.75

Intersection Summary

Area Type: CBD
 Cycle Length: 120
 Actuated Cycle Length: 120
 Offset: 39 (33%), Referenced to phase 2:NBTL, Start of Green
 Natural Cycle: 135
 Control Type: Actuated-Coordinated
 Maximum v/c Ratio: 0.75
 Intersection Signal Delay: 28.7
 Intersection LOS: C
 Intersection Capacity Utilization 69.0%
 ICU Level of Service C
 Analysis Period (min) 15
 m Volume for 95th percentile queue is metered by upstream signal.

Splits and Phases: 16: NC 86 (S. Columbia St) & W. Cameron Avenue/E. Cameron Avenue

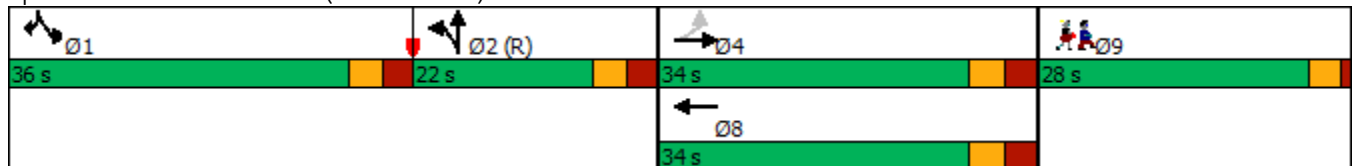

Lanes, Volumes, Timings

16: NC 86 (S. Columbia St) & W. Cameron Avenue/E. Cameron Avenue

09/01/2020

Lane Group	Ø9
Actuated g/C Ratio	
v/c Ratio	
Control Delay	
Queue Delay	
Total Delay	
LOS	
Approach Delay	
Approach LOS	
Queue Length 50th (ft)	
Queue Length 95th (ft)	
Internal Link Dist (ft)	
Turn Bay Length (ft)	
Base Capacity (vph)	
Starvation Cap Reductn	
Spillback Cap Reductn	
Storage Cap Reductn	
Reduced v/c Ratio	
Intersection Summary	

Lanes, Volumes, Timings

17: Raleigh Street & E. Cameron Avenue/Country Club Road

09/01/2020

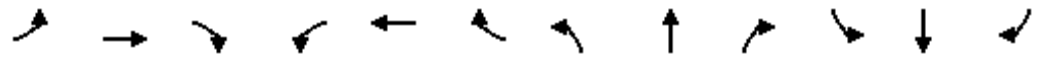

Lane Group	EBL	EBT	EBR	WBL	WBT	WBR	NBL	NBT	NBR	SBL	SBT	SBR
Lane Configurations		↕		↖	↗		↖	↗		↖	↗	
Traffic Volume (vph)	23	44	32	28	143	224	24	45	17	303	149	48
Future Volume (vph)	23	44	32	28	143	224	24	45	17	303	149	48
Ideal Flow (vphpl)	1900	1900	1900	1900	1900	1900	1900	1900	1900	1900	1900	1900
Grade (%)		-3%			3%			-2%				1%
Storage Length (ft)	0		0	150		0	125		0	75		0
Storage Lanes	0		0	1		0	1		0	1		0
Taper Length (ft)	25			25			25			25		
Lane Util. Factor	1.00	1.00	1.00	1.00	1.00	1.00	1.00	1.00	1.00	1.00	1.00	1.00
Ped Bike Factor		0.98		0.98	0.98		0.91	0.96		0.89	0.95	
Frt		0.956			0.908			0.958			0.964	
Flt Protected		0.989		0.950			0.950			0.950		
Satd. Flow (prot)	0	1493	0	1569	1468	0	1492	1446	0	1569	1511	0
Flt Permitted		0.834		0.574			0.626			0.459		
Satd. Flow (perm)	0	1257	0	934	1468	0	894	1446	0	677	1511	0
Right Turn on Red			No			No			No			No
Satd. Flow (RTOR)												
Link Speed (mph)		25			25			25				25
Link Distance (ft)		598			651			409				995
Travel Time (s)		16.3			17.8			11.2				27.1
Confl. Peds. (#/hr)	3		6	6		3	31		25	25		31
Peak Hour Factor	0.71	0.71	0.71	0.84	0.84	0.84	0.79	0.79	0.79	0.94	0.94	0.94
Heavy Vehicles (%)	8%	8%	8%	2%	2%	2%	10%	10%	10%	3%	3%	3%
Adj. Flow (vph)	32	62	45	33	170	267	30	57	22	322	159	51
Shared Lane Traffic (%)												
Lane Group Flow (vph)	0	139	0	33	437	0	30	79	0	322	210	0
Turn Type	Perm	NA		pm+pt	NA		pm+pt	NA		pm+pt	NA	
Protected Phases		2		1	6		3	8		7	4	
Permitted Phases	2			6			8			4		
Detector Phase	2	2		1	6		3	8		7	4	
Switch Phase												
Minimum Initial (s)	10.0	10.0		7.0	10.0		7.0	7.0		7.0	7.0	
Minimum Split (s)	18.0	18.0		13.0	19.0		13.0	19.0		12.0	16.0	
Total Split (s)	50.0	50.0		20.0	70.0		20.0	35.0		20.0	35.0	
Total Split (%)	40.0%	40.0%		16.0%	56.0%		16.0%	28.0%		16.0%	28.0%	
Maximum Green (s)	43.9	43.9		14.4	64.4		14.7	29.7		15.1	29.9	
Yellow Time (s)	3.3	3.3		3.0	3.1		3.0	3.1		3.0	3.1	
All-Red Time (s)	2.8	2.8		2.6	2.5		2.3	2.2		1.9	2.0	
Lost Time Adjust (s)		-1.1		-0.6	-0.6		-0.3	-0.3		0.1	-0.1	
Total Lost Time (s)		5.0		5.0	5.0		5.0	5.0		5.0	5.0	
Lead/Lag	Lag	Lag		Lead			Lead	Lag		Lead	Lag	
Lead-Lag Optimize?	Yes	Yes		Yes			Yes	Yes		Yes	Yes	
Vehicle Extension (s)	2.0	2.0		2.0	2.0		2.0	2.0		2.0	2.0	
Recall Mode	None	None		None	None		None	None		None	None	
Walk Time (s)	4.0	4.0			4.0			4.0			4.0	
Flash Dont Walk (s)	7.0	7.0			9.0			9.0			6.0	
Pedestrian Calls (#/hr)	0	0			0			0			0	
Act Effect Green (s)		20.6		24.7	24.7		15.5	10.2		25.6	21.7	
Actuated g/C Ratio		0.33		0.40	0.40		0.25	0.17		0.42	0.35	

Lanes, Volumes, Timings

17: Raleigh Street & E. Cameron Avenue/Country Club Road

09/01/2020

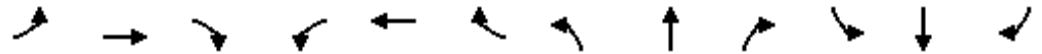

Lane Group	EBL	EBT	EBR	WBL	WBT	WBR	NBL	NBT	NBR	SBL	SBT	SBR
v/c Ratio		0.33		0.07	0.74		0.10	0.33		0.65	0.39	
Control Delay		22.0		12.5	25.4		15.1	32.4		22.8	22.5	
Queue Delay		0.0		0.0	0.0		0.0	0.0		0.0	0.0	
Total Delay		22.0		12.5	25.4		15.1	32.4		22.8	22.5	
LOS		C		B	C		B	C		C	C	
Approach Delay		22.0			24.5			27.6			22.7	
Approach LOS		C			C			C			C	
Queue Length 50th (ft)		35		8	141		6	28		80	48	
Queue Length 95th (ft)		80		23	243		24	70		#235	170	
Internal Link Dist (ft)		518			571			329			915	
Turn Bay Length (ft)				150			125			75		
Base Capacity (vph)		923		570	1368		516	797		552	833	
Starvation Cap Reductn		0		0	0		0	0		0	0	
Spillback Cap Reductn		0		0	0		0	0		0	0	
Storage Cap Reductn		0		0	0		0	0		0	0	
Reduced v/c Ratio		0.15		0.06	0.32		0.06	0.10		0.58	0.25	

Intersection Summary

Area Type: CBD
 Cycle Length: 125
 Actuated Cycle Length: 61.6
 Natural Cycle: 65
 Control Type: Actuated-Uncoordinated
 Maximum v/c Ratio: 0.74
 Intersection Signal Delay: 23.7
 Intersection LOS: C
 Intersection Capacity Utilization 61.9%
 ICU Level of Service B
 Analysis Period (min) 15
 # 95th percentile volume exceeds capacity, queue may be longer.
 Queue shown is maximum after two cycles.

Splits and Phases: 17: Raleigh Street & E. Cameron Avenue/Country Club Road



Lanes, Volumes, Timings
1: Church Street & W. Rosemary Street

09/01/2020



Lane Group	EBL	EBT	EBR	WBL	WBT	WBR	NBL	NBT	NBR	SBL	SBT	SBR
Lane Configurations		↕			↕			↕			↕	
Traffic Volume (vph)	6	331	29	46	361	24	23	42	61	14	33	10
Future Volume (vph)	6	331	29	46	361	24	23	42	61	14	33	10
Ideal Flow (vphpl)	1900	1900	1900	1900	1900	1900	1900	1900	1900	1900	1900	1900
Lane Width (ft)	12	14	12	12	14	12	12	12	12	12	12	12
Grade (%)		1%			-1%			0%			0%	
Lane Util. Factor	1.00	1.00	1.00	1.00	1.00	1.00	1.00	1.00	1.00	1.00	1.00	1.00
Ped Bike Factor		0.99			0.99			0.92			0.95	
Frt		0.989			0.992			0.935			0.976	
Flt Protected		0.999			0.995			0.991			0.988	
Satd. Flow (prot)	0	1710	0	0	1748	0	0	1472	0	0	1562	0
Flt Permitted		0.994			0.931			0.924			0.917	
Satd. Flow (perm)	0	1700	0	0	1629	0	0	1334	0	0	1425	0
Right Turn on Red			No			No			No			No
Satd. Flow (RTOR)												
Link Speed (mph)		20			20			25			25	
Link Distance (ft)		964			757			379			430	
Travel Time (s)		32.9			25.8			10.3			11.7	
Confl. Peds. (#/hr)	22		24	24		22	75		39	39		75
Peak Hour Factor	0.88	0.88	0.88	0.93	0.93	0.93	0.92	0.92	0.92	0.64	0.64	0.64
Heavy Vehicles (%)	4%	4%	4%	3%	3%	3%	2%	2%	2%	2%	2%	2%
Adj. Flow (vph)	7	376	33	49	388	26	25	46	66	22	52	16
Shared Lane Traffic (%)												
Lane Group Flow (vph)	0	416	0	0	463	0	0	137	0	0	90	0
Turn Type	Perm	NA		Perm	NA		Perm	NA		Perm	NA	
Protected Phases		2			6			8			4	
Permitted Phases	2			6			8			4		
Detector Phase	2	2		6	6		8	8		4	4	
Switch Phase												
Minimum Initial (s)	10.0	10.0		10.0	10.0		7.0	7.0		7.0	7.0	
Minimum Split (s)	19.0	19.0		20.0	20.0		19.0	19.0		19.0	19.0	
Total Split (s)	43.0	43.0		43.0	43.0		22.0	22.0		22.0	22.0	
Total Split (%)	66.2%	66.2%		66.2%	66.2%		33.8%	33.8%		33.8%	33.8%	
Maximum Green (s)	38.5	38.5		38.4	38.4		17.1	17.1		17.1	17.1	
Yellow Time (s)	3.1	3.1		3.1	3.1		3.2	3.2		3.2	3.2	
All-Red Time (s)	1.4	1.4		1.5	1.5		1.7	1.7		1.7	1.7	
Lost Time Adjust (s)		0.5			0.4			0.1			0.1	
Total Lost Time (s)		5.0			5.0			5.0			5.0	
Lead/Lag												
Lead-Lag Optimize?												
Vehicle Extension (s)	3.0	3.0		3.0	3.0		3.0	3.0		3.0	3.0	
Recall Mode	C-Max	C-Max		C-Max	C-Max		None	None		None	None	
Walk Time (s)	4.0	4.0		4.0	4.0		4.0	4.0		4.0	4.0	
Flash Dont Walk (s)	5.0	5.0		6.0	6.0		10.0	10.0		10.0	10.0	
Pedestrian Calls (#/hr)	0	0		0	0		0	0		0	0	
Act Effct Green (s)		46.7			46.7			11.7			11.7	
Actuated g/C Ratio		0.72			0.72			0.18			0.18	
v/c Ratio		0.34			0.40			0.57			0.35	
Control Delay		6.3			2.5			32.4			25.8	

Lanes, Volumes, Timings
 1: Church Street & W. Rosemary Street

09/01/2020



Lane Group	EBL	EBT	EBR	WBL	WBT	WBR	NBL	NBT	NBR	SBL	SBT	SBR
Queue Delay		0.0			0.0			0.0			0.0	
Total Delay		6.3			2.5			32.4			25.8	
LOS		A			A			C			C	
Approach Delay		6.3			2.5			32.4			25.8	
Approach LOS		A			A			C			C	
Queue Length 50th (ft)		60			20			52			32	
Queue Length 95th (ft)		129			46			66			43	
Internal Link Dist (ft)		884			677			299			350	
Turn Bay Length (ft)												
Base Capacity (vph)		1220			1169			348			372	
Starvation Cap Reductn		0			0			0			0	
Spillback Cap Reductn		0			0			0			0	
Storage Cap Reductn		0			0			0			0	
Reduced v/c Ratio		0.34			0.40			0.39			0.24	

Intersection Summary

Area Type:	CBD
Cycle Length:	65
Actuated Cycle Length:	65
Offset:	23 (35%), Referenced to phase 2:EBTL and 6:WBTL, Start of Green
Natural Cycle:	40
Control Type:	Actuated-Coordinated
Maximum v/c Ratio:	0.57
Intersection Signal Delay:	9.5
Intersection LOS:	A
Intersection Capacity Utilization	71.6%
ICU Level of Service	C
Analysis Period (min)	15

Splits and Phases: 1: Church Street & W. Rosemary Street



Lanes, Volumes, Timings

2: NC 86 (N. Columbia St) & W. Rosemary Street/E. Rosemary Street

09/01/2020



Lane Group	EBL	EBT	EBR	WBL	WBT	WBR	NBL	NBT	NBR	SBL	SBT	SBR
Lane Configurations												
Traffic Volume (vph)	157	212	48	72	224	49	44	318	141	61	360	180
Future Volume (vph)	157	212	48	72	224	49	44	318	141	61	360	180
Ideal Flow (vphpl)	1900	1900	1900	1900	1900	1900	1900	1900	1900	1900	1900	1900
Lane Width (ft)	9	12	13	12	12	12	9	10	12	12	9	11
Grade (%)		1%			1%			-2%			8%	
Storage Length (ft)	100		0	150		0	75		0	150		400
Storage Lanes	1		0	1		0	1		0	1		1
Taper Length (ft)	25			25			25			25		
Lane Util. Factor	1.00	1.00	1.00	1.00	1.00	1.00	1.00	0.95	0.95	1.00	0.95	1.00
Ped Bike Factor	0.97	0.99		0.96	0.98		0.86	0.85		0.80		0.66
Frt		0.972			0.973			0.954				0.850
Flt Protected	0.950			0.950			0.950			0.950		
Satd. Flow (prot)	1426	1599	0	1585	1597	0	1355	2265	0	1485	2673	1285
Flt Permitted	0.254			0.579			0.442			0.411		
Satd. Flow (perm)	369	1599	0	925	1597	0	539	2265	0	517	2673	850
Right Turn on Red			No			No			No			No
Satd. Flow (RTOR)												
Link Speed (mph)		20			20			25			25	
Link Distance (ft)		757			456			353			476	
Travel Time (s)		25.8			15.5			9.6			13.0	
Confl. Peds. (#/hr)	53		41	41		53	80		129	129		80
Peak Hour Factor	0.88	0.88	0.88	0.85	0.85	0.85	0.98	0.98	0.98	0.86	0.86	0.86
Heavy Vehicles (%)	2%	2%	2%	2%	2%	2%	9%	9%	9%	5%	5%	5%
Adj. Flow (vph)	178	241	55	85	264	58	45	324	144	71	419	209
Shared Lane Traffic (%)												
Lane Group Flow (vph)	178	296	0	85	322	0	45	468	0	71	419	209
Turn Type	pm+pt	NA		Perm	NA		pm+pt	NA		pm+pt	NA	pm+ov
Protected Phases	7	4			8		5	2		1	6	7
Permitted Phases	4			8			2			6		6
Detector Phase	7	4		8	8		5	2		1	6	7
Switch Phase												
Minimum Initial (s)	7.0	7.0		7.0	7.0		7.0	10.0		7.0	10.0	7.0
Minimum Split (s)	13.0	31.0		32.0	32.0		13.0	23.0		13.0	22.0	13.0
Total Split (s)	43.0	63.0		20.0	20.0		15.0	52.0		15.0	52.0	43.0
Total Split (%)	33.1%	48.5%		15.4%	15.4%		11.5%	40.0%		11.5%	40.0%	33.1%
Maximum Green (s)	37.2	57.0		14.0	14.0		9.2	46.2		9.9	46.2	37.2
Yellow Time (s)	3.0	3.2		3.2	3.2		3.0	3.3		3.0	3.3	3.0
All-Red Time (s)	2.8	2.8		2.8	2.8		2.8	2.5		2.1	2.5	2.8
Lost Time Adjust (s)	-0.8	-1.0		-1.0	-1.0		0.0	-0.8		-0.1	-0.8	-0.8
Total Lost Time (s)	5.0	5.0		5.0	5.0		5.8	5.0		5.0	5.0	5.0
Lead/Lag	Lead			Lag	Lag		Lead	Lag		Lead	Lag	Lead
Lead-Lag Optimize?												
Vehicle Extension (s)	1.0	1.0		1.0	1.0		1.0	3.0		1.0	3.0	1.0
Recall Mode	None	None		None	None		None	C-Max		None	C-Max	None
Walk Time (s)		7.0		7.0	7.0			7.0			7.0	
Flash Dont Walk (s)		18.0		19.0	19.0			10.0			9.0	
Pedestrian Calls (#/hr)		0		0	0			0			0	
Act Effect Green (s)	58.0	58.0		33.4	33.4		56.6	51.5		58.0	51.5	71.1

Lanes, Volumes, Timings

2: NC 86 (N. Columbia St) & W. Rosemary Street/E. Rosemary Street

09/01/2020



Lane Group	EBL	EBT	EBR	WBL	WBT	WBR	NBL	NBT	NBR	SBL	SBT	SBR
Actuated g/C Ratio	0.45	0.45		0.26	0.26		0.44	0.40		0.45	0.40	0.55
v/c Ratio	0.55	0.42		0.36	0.79		0.16	0.52		0.25	0.40	0.39
Control Delay	30.1	27.6		44.9	57.9		16.6	20.4		14.6	19.5	8.9
Queue Delay	0.0	0.0		0.0	0.0		0.0	0.5		0.0	0.0	0.0
Total Delay	30.1	27.6		44.9	57.9		16.6	20.9		14.6	19.5	8.9
LOS	C	C		D	E		B	C		B	B	A
Approach Delay		28.6			55.2			20.5			15.9	
Approach LOS		C			E			C			B	
Queue Length 50th (ft)	92	192		51	236		11	62		17	71	36
Queue Length 95th (ft)	123	245		112	#426		m26	137		27	86	32
Internal Link Dist (ft)		677			376			273			396	
Turn Bay Length (ft)	100			150			75			150		400
Base Capacity (vph)	473	713		237	409		298	897		310	1058	712
Starvation Cap Reductn	0	0		0	0		0	149		0	0	0
Spillback Cap Reductn	0	0		0	0		0	0		0	0	0
Storage Cap Reductn	0	0		0	0		0	0		0	0	0
Reduced v/c Ratio	0.38	0.42		0.36	0.79		0.15	0.63		0.23	0.40	0.29

Intersection Summary

Area Type: CBD
 Cycle Length: 130
 Actuated Cycle Length: 130
 Offset: 55 (42%), Referenced to phase 2:NBTL and 6:SBTL, Start of Green
 Natural Cycle: 85
 Control Type: Actuated-Coordinated
 Maximum v/c Ratio: 0.79
 Intersection Signal Delay: 27.5 Intersection LOS: C
 Intersection Capacity Utilization 69.9% ICU Level of Service C
 Analysis Period (min) 15
 # 95th percentile volume exceeds capacity, queue may be longer.
 Queue shown is maximum after two cycles.
 m Volume for 95th percentile queue is metered by upstream signal.

Splits and Phases: 2: NC 86 (N. Columbia St) & W. Rosemary Street/E. Rosemary Street

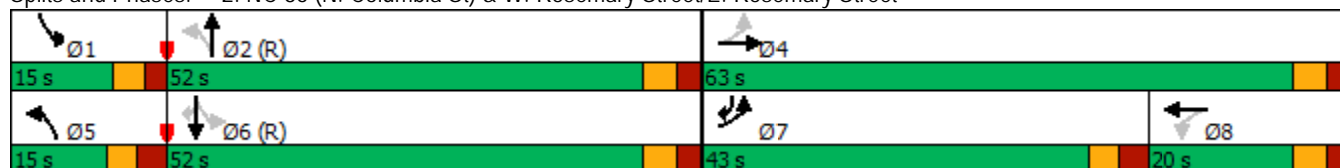

Lanes, Volumes, Timings
6: Henderson Street & E. Rosemary Street

09/01/2020



Lane Group	EBL	EBT	EBR	WBL	WBT	WBR	NBL	NBT	NBR	SBL	SBT	SBR
Lane Configurations												
Traffic Volume (vph)	15	201	130	15	217	31	64	30	11	9	38	13
Future Volume (vph)	15	201	130	15	217	31	64	30	11	9	38	13
Ideal Flow (vphpl)	1900	1900	1900	1900	1900	1900	1900	1900	1900	1900	1900	1900
Grade (%)		0%			0%			0%				3%
Storage Length (ft)	85		0	0		0	0		0	0		0
Storage Lanes	1		0	0		0	0		0	0		0
Taper Length (ft)	25			25			25			25		
Lane Util. Factor	1.00	1.00	1.00	1.00	1.00	1.00	1.00	1.00	1.00	1.00	1.00	1.00
Ped Bike Factor	0.96	0.97			0.99			0.84				0.93
Frt		0.941			0.984			0.986				0.971
Flt Protected	0.950				0.997			0.970				0.992
Satd. Flow (prot)	1593	1531	0	0	1629	0	0	1581	0	0	1497	0
Flt Permitted	0.630				0.977			0.772				0.941
Satd. Flow (perm)	1018	1531	0	0	1593	0	0	1074	0	0	1400	0
Right Turn on Red			No			No			No			No
Satd. Flow (RTOR)												
Link Speed (mph)		20			20			20				20
Link Distance (ft)		242			1195			366				450
Travel Time (s)		8.3			40.7			12.5				15.3
Confl. Peds. (#/hr)	21		19	19		21	106		47	47		106
Peak Hour Factor	0.96	0.96	0.96	0.95	0.95	0.95	0.68	0.68	0.68	0.85	0.85	0.85
Adj. Flow (vph)	16	209	135	16	228	33	94	44	16	11	45	15
Shared Lane Traffic (%)												
Lane Group Flow (vph)	16	344	0	0	277	0	0	154	0	0	71	0
Turn Type	Perm	NA		Perm	NA		Perm	NA		Perm	NA	
Protected Phases		2			2			4				4
Permitted Phases	2			2			4			4		
Detector Phase	2	2		2	2		4	4		4		4
Switch Phase												
Minimum Initial (s)	11.0	11.0		11.0	11.0		8.0	8.0		8.0		8.0
Minimum Split (s)	15.9	15.9		15.9	15.9		17.8	17.8		17.8		17.8
Total Split (s)	38.0	38.0		38.0	38.0		27.0	27.0		27.0		27.0
Total Split (%)	58.5%	58.5%		58.5%	58.5%		41.5%	41.5%		41.5%		41.5%
Maximum Green (s)	33.1	33.1		33.1	33.1		22.2	22.2		22.2		22.2
Yellow Time (s)	3.3	3.3		3.3	3.3		3.3	3.3		3.3		3.3
All-Red Time (s)	1.6	1.6		1.6	1.6		1.5	1.5		1.5		1.5
Lost Time Adjust (s)	0.1	0.1			0.1			0.2				0.2
Total Lost Time (s)	5.0	5.0			5.0			5.0				5.0
Lead/Lag												
Lead-Lag Optimize?												
Vehicle Extension (s)	2.0	2.0		2.0	2.0		2.0	2.0		2.0		2.0
Recall Mode	C-Max	C-Max		C-Max	C-Max		None	None		None		None
Walk Time (s)	4.0	4.0		4.0	4.0		4.0	4.0		4.0		4.0
Flash Dont Walk (s)	7.0	7.0		7.0	7.0		9.0	9.0		9.0		9.0
Pedestrian Calls (#/hr)	0	0		0	0		0	0		0		0
Act Effct Green (s)	45.0	45.0			45.0			13.6				13.6
Actuated g/C Ratio	0.69	0.69			0.69			0.21				0.21
v/c Ratio	0.02	0.32			0.25			0.69				0.24

Lanes, Volumes, Timings
 6: Henderson Street & E. Rosemary Street

09/01/2020



Lane Group	EBL	EBT	EBR	WBL	WBT	WBR	NBL	NBT	NBR	SBL	SBT	SBR
Control Delay	6.7	6.8			6.7			36.5			21.5	
Queue Delay	0.0	0.0			0.0			0.0			0.0	
Total Delay	6.7	6.8			6.7			36.5			21.5	
LOS	A	A			A			D			C	
Approach Delay		6.8			6.7			36.5			21.5	
Approach LOS		A			A			D			C	
Queue Length 50th (ft)	2	53			63			69			24	
Queue Length 95th (ft)	m10	134			119			68			45	
Internal Link Dist (ft)		162			1115			286			370	
Turn Bay Length (ft)	85											
Base Capacity (vph)	704	1060			1102			363			473	
Starvation Cap Reductn	0	0			0			0			0	
Spillback Cap Reductn	0	0			0			0			0	
Storage Cap Reductn	0	0			0			0			0	
Reduced v/c Ratio	0.02	0.32			0.25			0.42			0.15	

Intersection Summary

Area Type: CBD
 Cycle Length: 65
 Actuated Cycle Length: 65
 Offset: 63 (97%), Referenced to phase 2:EBWB, Start of Green
 Natural Cycle: 40
 Control Type: Actuated-Coordinated
 Maximum v/c Ratio: 0.69
 Intersection Signal Delay: 13.3
 Intersection LOS: B
 Intersection Capacity Utilization 50.7%
 ICU Level of Service A
 Analysis Period (min) 15
 m Volume for 95th percentile queue is metered by upstream signal.

Splits and Phases: 6: Henderson Street & E. Rosemary Street



Lanes, Volumes, Timings
7: Hillsborough Street & E. Rosemary Street

09/01/2020



Lane Group	EBL	EBT	EBR	WBL	WBT	WBR	NBL	NBT	NBR	SBL	SBT	SBR
Lane Configurations		↕			↕		↗	↘		↗	↘	
Traffic Volume (vph)	25	91	93	3	52	9	172	181	9	16	220	28
Future Volume (vph)	25	91	93	3	52	9	172	181	9	16	220	28
Ideal Flow (vphp)	1900	1900	1900	1900	1900	1900	1900	1900	1900	1900	1900	1900
Storage Length (ft)	0		0	0		0	100		0	100		0
Storage Lanes	0		0	0		0	1		0	1		0
Taper Length (ft)	25			25			25			25		
Lane Util. Factor	1.00	1.00	1.00	1.00	1.00	1.00	1.00	1.00	1.00	1.00	1.00	1.00
Ped Bike Factor		0.95			0.98		0.93	1.00		0.99	0.98	
Frt		0.940			0.980			0.993			0.983	
Flt Protected		0.994			0.998		0.950			0.950		
Satd. Flow (prot)	0	1668	0	0	1792	0	1770	1847	0	1719	1743	0
Flt Permitted		0.955			0.982		0.481			0.623		
Satd. Flow (perm)	0	1586	0	0	1759	0	834	1847	0	1114	1743	0
Right Turn on Red			No			No			No			No
Satd. Flow (RTOR)												
Link Speed (mph)		20			20			25			25	
Link Distance (ft)		1195			527			363			726	
Travel Time (s)		40.7			18.0			9.9			19.8	
Confl. Peds. (#/hr)	35		35	35		35	50		5	5		50
Peak Hour Factor	0.93	0.93	0.93	0.78	0.78	0.78	0.88	0.88	0.88	0.91	0.91	0.91
Heavy Vehicles (%)	2%	2%	2%	2%	2%	2%	2%	2%	2%	5%	5%	5%
Adj. Flow (vph)	27	98	100	4	67	12	195	206	10	18	242	31
Shared Lane Traffic (%)												
Lane Group Flow (vph)	0	225	0	0	83	0	195	216	0	18	273	0
Turn Type	Perm	NA		Perm	NA		pm+pt	NA		Perm	NA	
Protected Phases		4			8		5	2			6	
Permitted Phases	4			8			2			6		
Detector Phase	4	4		8	8		5	2		6	6	
Switch Phase												
Minimum Initial (s)	7.0	7.0		7.0	7.0		7.0	10.0		10.0	10.0	
Minimum Split (s)	20.0	20.0		17.0	17.0		12.0	15.0		15.0	15.0	
Total Split (s)	24.0	24.0		24.0	24.0		13.0	41.0		28.0	28.0	
Total Split (%)	36.9%	36.9%		36.9%	36.9%		20.0%	63.1%		43.1%	43.1%	
Maximum Green (s)	19.1	19.1		19.0	19.0		8.2	36.2		23.2	23.2	
Yellow Time (s)	3.0	3.0		3.3	3.3		3.0	3.3		3.1	3.1	
All-Red Time (s)	1.9	1.9		1.7	1.7		1.8	1.5		1.7	1.7	
Lost Time Adjust (s)		0.1			0.0		0.2	0.2		0.2	0.2	
Total Lost Time (s)		5.0			5.0		5.0	5.0		5.0	5.0	
Lead/Lag							Lead			Lag	Lag	
Lead-Lag Optimize?												
Vehicle Extension (s)	2.0	2.0		2.0	2.0		2.0	2.0		2.0	2.0	
Recall Mode	None	None		None	None		None	C-Max		C-Max	C-Max	
Walk Time (s)	4.0	4.0		4.0	4.0			4.0		4.0	4.0	
Flash Dont Walk (s)	11.0	11.0		8.0	8.0			6.0		6.0	6.0	
Pedestrian Calls (#/hr)	0	0		0	0			0		0	0	
Act Effct Green (s)		13.3			13.3		41.7	41.7		29.2	29.2	
Actuated g/C Ratio		0.20			0.20		0.64	0.64		0.45	0.45	
v/c Ratio		0.69			0.23		0.30	0.18		0.04	0.35	

Lanes, Volumes, Timings
 7: Hillsborough Street & E. Rosemary Street

09/01/2020



Lane Group	EBL	EBT	EBR	WBL	WBT	WBR	NBL	NBT	NBR	SBL	SBT	SBR
Control Delay		32.7			21.4		6.4	5.6		13.0	14.9	
Queue Delay		0.0			0.0		0.0	0.0		0.0	0.0	
Total Delay		32.7			21.4		6.4	5.6		13.0	14.9	
LOS		C			C		A	A		B	B	
Approach Delay		32.7			21.4			5.9			14.7	
Approach LOS		C			C			A			B	
Queue Length 50th (ft)		87			28		52	58		4	66	
Queue Length 95th (ft)		114			46		65	73		17	142	
Internal Link Dist (ft)		1115			447			283			646	
Turn Bay Length (ft)							100			100		
Base Capacity (vph)		463			514		651	1184		500	783	
Starvation Cap Reductn		0			0		0	0		0	0	
Spillback Cap Reductn		0			0		0	0		0	0	
Storage Cap Reductn		0			0		0	0		0	0	
Reduced v/c Ratio		0.49			0.16		0.30	0.18		0.04	0.35	

Intersection Summary

Area Type:	Other
Cycle Length:	65
Actuated Cycle Length:	65
Offset:	19 (29%), Referenced to phase 2:NBTL and 6:SBTL, Start of Green
Natural Cycle:	50
Control Type:	Actuated-Coordinated
Maximum v/c Ratio:	0.69
Intersection Signal Delay:	15.7
Intersection LOS:	B
Intersection Capacity Utilization	55.6%
ICU Level of Service	B
Analysis Period (min)	15

Splits and Phases: 7: Hillsborough Street & E. Rosemary Street

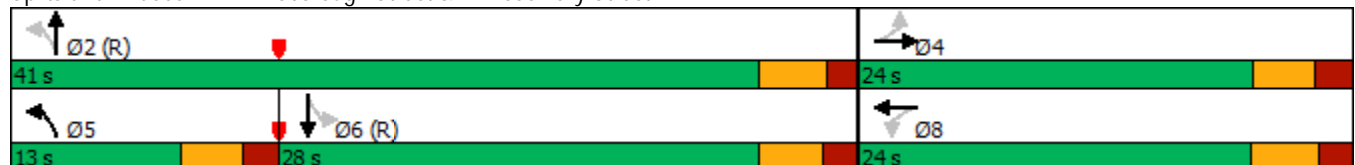

Lanes, Volumes, Timings

8: Carolina Square Driveway/Church Street & W. Franklin Street

09/01/2020



Lane Group	EBL	EBT	EBR	WBL	WBT	WBR	NBL	NBT	NBR	SBL	SBT	SBR
Lane Configurations												
Traffic Volume (vph)	56	367	26	32	336	69	10	10	22	23	23	60
Future Volume (vph)	56	367	26	32	336	69	10	10	22	23	23	60
Ideal Flow (vphpl)	1900	1900	1900	1900	1900	1900	1900	1900	1900	1900	1900	1900
Lane Width (ft)	10	10	16	10	10	10	12	12	12	12	12	12
Grade (%)		2%			-2%			-4%				-3%
Storage Length (ft)	150		0	200		0	0		100	0		0
Storage Lanes	1		0	1		0	0		1	0		0
Taper Length (ft)	25			25			25			25		
Lane Util. Factor	1.00	1.00	1.00	1.00	1.00	1.00	1.00	1.00	1.00	1.00	1.00	1.00
Ped Bike Factor	0.85	0.97		0.79	0.93			0.86	0.87		0.78	
Frt		0.990			0.974				0.850		0.923	
Flt Protected	0.950			0.950				0.976			0.989	
Satd. Flow (prot)	1443	1453	0	1472	1410	0	0	1669	1454	0	1198	0
Flt Permitted	0.475			0.470				0.827			0.928	
Satd. Flow (perm)	610	1453	0	573	1410	0	0	1221	1262	0	1098	0
Right Turn on Red			No			No			No			No
Satd. Flow (RTOR)												
Link Speed (mph)		20			20			20			25	
Link Distance (ft)		993			298			285			379	
Travel Time (s)		33.9			10.2			9.7			10.3	
Confl. Peds. (#/hr)	150		248	248		150	225		77	77		225
Peak Hour Factor	0.87	0.87	0.87	0.91	0.91	0.91	0.81	0.81	0.81	0.71	0.71	0.71
Heavy Vehicles (%)	4%	4%	4%	4%	4%	4%	2%	2%	2%	5%	5%	5%
Adj. Flow (vph)	64	422	30	35	369	76	12	12	27	32	32	85
Shared Lane Traffic (%)												
Lane Group Flow (vph)	64	452	0	35	445	0	0	24	27	0	149	0
Turn Type	Perm	NA		Perm	NA		Perm	NA	Perm	Perm	NA	
Protected Phases		2			6			8				4
Permitted Phases	2			6			8		8	4		
Detector Phase	2	2		6	6		8	8	8	4	4	
Switch Phase												
Minimum Initial (s)	10.0	10.0		10.0	10.0		7.0	7.0	7.0	7.0	7.0	
Minimum Split (s)	22.0	22.0		19.0	19.0		29.0	29.0	29.0	27.0	27.0	
Total Split (s)	36.0	36.0		36.0	36.0		29.0	29.0	29.0	29.0	29.0	
Total Split (%)	55.4%	55.4%		55.4%	55.4%		44.6%	44.6%	44.6%	44.6%	44.6%	
Maximum Green (s)	30.4	30.4		30.4	30.4		22.7	22.7	22.7	23.0	23.0	
Yellow Time (s)	3.3	3.3		3.3	3.3		3.1	3.1	3.1	3.4	3.4	
All-Red Time (s)	2.3	2.3		2.3	2.3		3.2	3.2	3.2	2.6	2.6	
Lost Time Adjust (s)	-0.6	-0.6		-0.6	-0.6		-1.3	-1.3	-1.3	-1.0	-1.0	
Total Lost Time (s)	5.0	5.0		5.0	5.0		5.0	5.0	5.0	5.0	5.0	
Lead/Lag												
Lead-Lag Optimize?												
Vehicle Extension (s)	3.0	3.0		3.0	3.0		2.0	2.0	2.0	2.0	2.0	
Recall Mode	C-Max	C-Max		C-Max	C-Max		None	None	None	None	None	
Walk Time (s)	7.0	7.0		7.0	7.0		7.0	7.0	7.0	7.0	7.0	
Flash Dont Walk (s)	9.0	9.0		6.0	6.0		15.0	15.0	15.0	14.0	14.0	
Pedestrian Calls (#/hr)	0	0		0	0		0	0	0	0	0	
Act Effect Green (s)	44.4	44.4		44.4	44.4		14.3	14.3	14.3	14.2	14.2	

Lanes, Volumes, Timings

8: Carolina Square Driveway/Church Street & W. Franklin Street

09/01/2020



Lane Group	EBL	EBT	EBR	WBL	WBT	WBR	NBL	NBT	NBR	SBL	SBT	SBR
Actuated g/C Ratio	0.68	0.68		0.68	0.68			0.22	0.22		0.22	
v/c Ratio	0.15	0.46		0.09	0.46			0.09	0.10		0.62	
Control Delay	8.0	9.5		8.8	11.6			18.3	18.5		32.4	
Queue Delay	0.0	0.0		0.0	0.0			0.0	0.0		0.0	
Total Delay	8.0	9.5		8.8	11.6			18.3	18.5		32.4	
LOS	A	A		A	B			B	B		C	
Approach Delay		9.3			11.4			18.4			32.4	
Approach LOS		A			B			B			C	
Queue Length 50th (ft)	9	82		3	46			8	9		63	
Queue Length 95th (ft)	32	186		m28	351			19	21		64	
Internal Link Dist (ft)		913			218			205			299	
Turn Bay Length (ft)	150			200					100			
Base Capacity (vph)	416	992		391	962			450	465		405	
Starvation Cap Reductn	0	0		0	0			0	0		0	
Spillback Cap Reductn	0	0		0	0			0	0		0	
Storage Cap Reductn	0	0		0	0			0	0		0	
Reduced v/c Ratio	0.15	0.46		0.09	0.46			0.05	0.06		0.37	

Intersection Summary

Area Type: CBD
 Cycle Length: 65
 Actuated Cycle Length: 65
 Offset: 2 (3%), Referenced to phase 2:EBTL and 6:WBTL, Start of Green
 Natural Cycle: 60
 Control Type: Actuated-Coordinated
 Maximum v/c Ratio: 0.62
 Intersection Signal Delay: 13.4 Intersection LOS: B
 Intersection Capacity Utilization 71.2% ICU Level of Service C
 Analysis Period (min) 15
 m Volume for 95th percentile queue is metered by upstream signal.

Splits and Phases: 8: Carolina Square Driveway/Church Street & W. Franklin Street



Lanes, Volumes, Timings

9: NC 86 (S. Columbia St)/NC 86 (N. Columbia St) & W. Franklin Street/E. Franklin Street 09/01/2020



Lane Group	EBL	EBT	EBR	WBL	WBT	WBR	NBL	NBT	NBR	SBL	SBT	SBR
Lane Configurations												
Traffic Volume (vph)	108	301	46	83	311	88	62	317	91	51	330	92
Future Volume (vph)	108	301	46	83	311	88	62	317	91	51	330	92
Ideal Flow (vphpl)	1900	1900	1900	1900	1900	1900	1900	1900	1900	1900	1900	1900
Lane Width (ft)	9	12	13	10	10	13	9	10	10	9	9	11
Grade (%)		3%			1%			-2%			3%	
Storage Length (ft)	250		0	125		0	475		0	125		0
Storage Lanes	1		0	1		1	1		0	1		0
Taper Length (ft)	25			25			25			25		
Lane Util. Factor	1.00	0.95	0.95	1.00	1.00	1.00	1.00	0.95	0.95	1.00	0.95	0.95
Ped Bike Factor	0.80	0.96		0.82		0.67	0.83	0.92		0.81	0.92	
Frt		0.980				0.850		0.967			0.967	
Flt Protected	0.950			0.950			0.950			0.950		
Satd. Flow (prot)	1372	2854	0	1437	1512	1423	1342	2477	0	1346	2400	0
Flt Permitted	0.950			0.950			0.950			0.950		
Satd. Flow (perm)	1097	2854	0	1179	1512	947	1109	2477	0	1087	2400	0
Right Turn on Red			No			No			No			No
Satd. Flow (RTOR)												
Link Speed (mph)		20			20			25			25	
Link Distance (ft)		457			941			981			353	
Travel Time (s)		15.6			32.1			26.8			9.6	
Confl. Peds. (#/hr)	251		248	248		251	117		321	321		117
Peak Hour Factor	0.80	0.80	0.80	0.87	0.87	0.87	0.93	0.93	0.93	0.85	0.85	0.85
Heavy Vehicles (%)	5%	5%	5%	5%	5%	5%	10%	10%	10%	7%	7%	7%
Adj. Flow (vph)	135	376	58	95	357	101	67	341	98	60	388	108
Shared Lane Traffic (%)												
Lane Group Flow (vph)	135	434	0	95	357	101	67	439	0	60	496	0
Turn Type	Prot	NA		Prot	NA	pm+ov	Prot	NA		Prot	NA	
Protected Phases	5	2		1	6	7	3	8		7	4	
Permitted Phases						6						
Detector Phase	5	2		1	6	7	3	8		7	4	
Switch Phase												
Minimum Initial (s)	7.0	10.0		7.0	10.0	7.0	7.0	7.0		7.0	7.0	
Minimum Split (s)	15.0	28.2		15.0	28.2	15.0	15.0	28.0		15.0	28.1	
Total Split (s)	25.0	32.0		25.0	32.0	25.0	25.0	48.0		25.0	48.0	
Total Split (%)	19.2%	24.6%		19.2%	24.6%	19.2%	19.2%	36.9%		19.2%	36.9%	
Maximum Green (s)	19.6	25.8		19.1	25.8	19.1	19.1	42.1		19.1	42.3	
Yellow Time (s)	3.0	3.0		3.0	3.0	3.0	3.0	3.3		3.0	3.1	
All-Red Time (s)	2.4	3.2		2.9	3.2	2.9	2.9	2.6		2.9	2.6	
Lost Time Adjust (s)	-0.4	-1.2		-0.9	-1.2	-2.0	-0.9	-0.9		-0.9	-0.7	
Total Lost Time (s)	5.0	5.0		5.0	5.0	3.9	5.0	5.0		5.0	5.0	
Lead/Lag	Lead	Lag		Lead	Lag	Lead	Lead	Lag		Lead	Lag	
Lead-Lag Optimize?												
Vehicle Extension (s)	1.0	3.0		1.0	3.0	1.0	1.0	2.0		1.0	2.0	
Recall Mode	None	C-Max		None	C-Max	None	None	Ped		None	Ped	
Walk Time (s)		7.0			7.0			7.0			7.0	
Flash Dont Walk (s)		15.0			15.0			15.0			15.0	
Pedestrian Calls (#/hr)		0			0			0			0	
Act Effect Green (s)	16.6	53.6		13.1	50.1	63.0	11.3	32.6		10.7	34.6	

Lanes, Volumes, Timings

9: NC 86 (S. Columbia St)/NC 86 (N. Columbia St) & W. Franklin Street/E. Franklin Street 09/01/2020



Lane Group	EBL	EBT	EBR	WBL	WBT	WBR	NBL	NBT	NBR	SBL	SBT	SBR
Actuated g/C Ratio	0.13	0.41		0.10	0.39	0.48	0.09	0.25		0.08	0.27	
v/c Ratio	0.77	0.37		0.66	0.61	0.20	0.58	0.71		0.55	0.78	
Control Delay	75.2	33.6		82.5	42.1	15.9	100.2	28.2		88.5	32.1	
Queue Delay	0.0	0.0		0.0	0.0	0.0	0.0	0.0		0.0	0.1	
Total Delay	75.2	33.6		82.5	42.1	15.9	100.2	28.2		88.5	32.2	
LOS	E	C		F	D	B	F	C		F	C	
Approach Delay		43.5			44.3			37.7			38.3	
Approach LOS		D			D			D			D	
Queue Length 50th (ft)	108	133		73	252	31	58	71		53	96	
Queue Length 95th (ft)	144	215		136	#503	76	107	66		95	99	
Internal Link Dist (ft)		377			861			901			273	
Turn Bay Length (ft)	250			125			475			125		
Base Capacity (vph)	219	1177		221	582	604	206	819		207	793	
Starvation Cap Reductn	0	0		0	0	0	0	0		0	16	
Spillback Cap Reductn	0	0		0	0	0	0	0		0	0	
Storage Cap Reductn	0	0		0	0	0	0	0		0	0	
Reduced v/c Ratio	0.62	0.37		0.43	0.61	0.17	0.33	0.54		0.29	0.64	

Intersection Summary

Area Type: CBD
 Cycle Length: 130
 Actuated Cycle Length: 130
 Offset: 0 (0%), Referenced to phase 2:EBT and 6:WBT, Start of Green
 Natural Cycle: 90
 Control Type: Actuated-Coordinated
 Maximum v/c Ratio: 0.78
 Intersection Signal Delay: 41.0 Intersection LOS: D
 Intersection Capacity Utilization 65.8% ICU Level of Service C
 Analysis Period (min) 15

95th percentile volume exceeds capacity, queue may be longer.
 Queue shown is maximum after two cycles.

Splits and Phases: 9: NC 86 (S. Columbia St)/NC 86 (N. Columbia St) & W. Franklin Street/E. Franklin Street

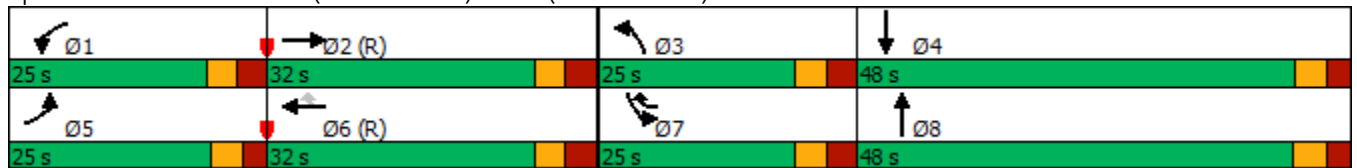

Lanes, Volumes, Timings
 10: E. Franklin Street & Henderson Street

09/01/2020



Lane Group	EBL	EBT	WBT	WBR	SBL	SBR
Lane Configurations		↑↑	↑↓		↑↓	
Traffic Volume (vph)	47	381	419	63	104	81
Future Volume (vph)	47	381	419	63	104	81
Ideal Flow (vphpl)	1900	1900	1900	1900	1900	1900
Lane Width (ft)	10	13	10	10	11	11
Grade (%)		-2%	2%		3%	
Lane Util. Factor	0.95	0.95	0.95	0.95	1.00	1.00
Ped Bike Factor		0.99	0.96		0.79	
Frt			0.980		0.941	
Flt Protected		0.995			0.973	
Satd. Flow (prot)	0	3213	2729	0	1256	0
Flt Permitted		0.861			0.973	
Satd. Flow (perm)	0	2745	2729	0	1162	0
Right Turn on Red				No		No
Satd. Flow (RTOR)						
Link Speed (mph)		20	20		20	
Link Distance (ft)		941	1200		366	
Travel Time (s)		32.1	40.9		12.5	
Confl. Peds. (#/hr)	119			119	130	370
Peak Hour Factor	0.95	0.95	0.92	0.92	0.87	0.87
Heavy Vehicles (%)	5%	5%	4%	4%	2%	2%
Parking (#/hr)						0
Adj. Flow (vph)	49	401	455	68	120	93
Shared Lane Traffic (%)						
Lane Group Flow (vph)	0	450	523	0	213	0
Turn Type	Perm	NA	NA		Prot	
Protected Phases		2	6		4	
Permitted Phases	2					
Detector Phase	2	2	6		4	
Switch Phase						
Minimum Initial (s)	10.0	10.0	10.0		7.0	
Minimum Split (s)	17.0	17.0	22.0		25.0	
Total Split (s)	32.0	32.0	32.0		33.0	
Total Split (%)	49.2%	49.2%	49.2%		50.8%	
Maximum Green (s)	25.8	25.8	25.9		27.9	
Yellow Time (s)	3.0	3.0	3.0		3.0	
All-Red Time (s)	3.2	3.2	3.1		2.1	
Lost Time Adjust (s)		-1.2	-1.1		-0.1	
Total Lost Time (s)		5.0	5.0		5.0	
Lead/Lag						
Lead-Lag Optimize?						
Vehicle Extension (s)	2.0	2.0	2.0		1.0	
Recall Mode	C-Max	C-Max	C-Max		None	
Walk Time (s)			7.0		7.0	
Flash Dont Walk (s)			8.0		12.0	
Pedestrian Calls (#/hr)			0		0	
Act Effct Green (s)		40.1	40.1		14.9	
Actuated g/C Ratio		0.62	0.62		0.23	
v/c Ratio		0.27	0.31		0.74	

Lanes, Volumes, Timings
 10: E. Franklin Street & Henderson Street

09/01/2020



Lane Group	EBL	EBT	WBT	WBR	SBL	SBR
Control Delay		7.2	8.8		35.8	
Queue Delay		0.0	0.0		0.0	
Total Delay		7.2	8.8		35.8	
LOS		A	A		D	
Approach Delay		7.2	8.8		35.8	
Approach LOS		A	A		D	
Queue Length 50th (ft)		16	38		91	
Queue Length 95th (ft)		170	170		131	
Internal Link Dist (ft)		861	1120		286	
Turn Bay Length (ft)						
Base Capacity (vph)		1691	1681		541	
Starvation Cap Reductn		0	0		0	
Spillback Cap Reductn		0	0		0	
Storage Cap Reductn		0	0		0	
Reduced v/c Ratio		0.27	0.31		0.39	

Intersection Summary

Area Type:	CBD
Cycle Length:	65
Actuated Cycle Length:	65
Offset:	4 (6%), Referenced to phase 2:EBTL and 6:WBT, Start of Green
Natural Cycle:	50
Control Type:	Actuated-Coordinated
Maximum v/c Ratio:	0.74
Intersection Signal Delay:	13.1
Intersection LOS:	B
Intersection Capacity Utilization:	57.6%
ICU Level of Service:	B
Analysis Period (min):	15

Splits and Phases: 10: E. Franklin Street & Henderson Street

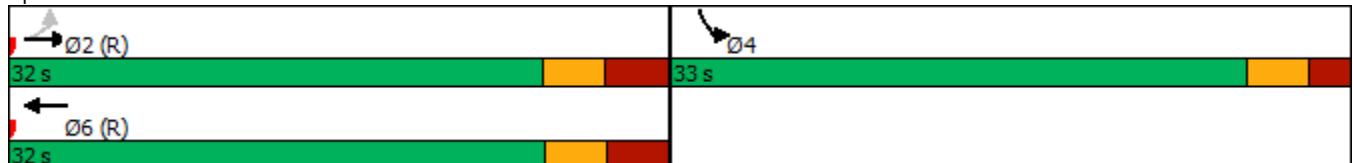

Lanes, Volumes, Timings

11: Raleigh Street/Hillsborough Street & E. Franklin Street

09/01/2020



Lane Group	EBL	EBT	EBR	WBL	WBT	WBR	NBL	NBT	NBR	SBL	SBT	SBR
Lane Configurations												
Traffic Volume (vph)	56	339	151	41	379	150	87	165	23	75	198	23
Future Volume (vph)	56	339	151	41	379	150	87	165	23	75	198	23
Ideal Flow (vphpl)	1900	1900	1900	1900	1900	1900	1900	1900	1900	1900	1900	1900
Lane Width (ft)	9	9	10	9	10	11	12	12	12	10	10	10
Grade (%)		1%			-2%			1%			1%	
Storage Length (ft)	75		0	75		0	0		0	100		0
Storage Lanes	1		0	1		0	0		0	1		0
Taper Length (ft)	25			25			25			25		
Lane Util. Factor	1.00	0.95	0.95	1.00	0.95	0.95	1.00	1.00	1.00	1.00	1.00	1.00
Ped Bike Factor	0.98	0.98		0.99	0.98			0.97		0.97	0.98	
Frt		0.954			0.957			0.989			0.984	
Flt Protected	0.950			0.950				0.984		0.950		
Satd. Flow (prot)	1539	2893	0	1593	3092	0	0	1794	0	1612	1639	0
Flt Permitted	0.401			0.423				0.673		0.499		
Satd. Flow (perm)	634	2893	0	700	3092	0	0	1197	0	821	1639	0
Right Turn on Red			No			No			No			No
Satd. Flow (RTOR)												
Link Speed (mph)		20			30			25			25	
Link Distance (ft)		1200			1013			995			363	
Travel Time (s)		40.9			23.0			27.1			9.9	
Confl. Peds. (#/hr)	50		25	25		50	93		33	33		93
Peak Hour Factor	0.91	0.91	0.91	0.91	0.91	0.91	0.94	0.94	0.94	0.90	0.90	0.90
Heavy Vehicles (%)	5%	5%	5%	3%	3%	3%	2%	2%	2%	4%	4%	4%
Adj. Flow (vph)	62	373	166	45	416	165	93	176	24	83	220	26
Shared Lane Traffic (%)												
Lane Group Flow (vph)	62	539	0	45	581	0	0	293	0	83	246	0
Turn Type	Perm	NA		Perm	NA		pm+pt	NA		D.Pm	NA	
Protected Phases		2			6		7	4				8
Permitted Phases	2			6			4			4		
Detector Phase	2	2		6	6		7	4		4		8
Switch Phase												
Minimum Initial (s)	10.0	10.0		10.0	10.0		7.0	7.0		7.0	7.0	
Minimum Split (s)	16.0	16.0		16.0	16.0		14.0	30.0		30.0	29.0	
Total Split (s)	60.0	60.0		60.0	60.0		31.0	70.0		70.0	39.0	
Total Split (%)	46.2%	46.2%		46.2%	46.2%		23.8%	53.8%		53.8%	30.0%	
Maximum Green (s)	54.7	54.7		54.7	54.7		24.8	63.6		63.6	32.6	
Yellow Time (s)	3.0	3.0		3.0	3.0		3.0	3.1		3.1	3.1	
All-Red Time (s)	2.3	2.3		2.3	2.3		3.2	3.3		3.3	3.3	
Lost Time Adjust (s)	-0.3	-0.3		-0.3	-0.3			-1.4		-1.4	-1.4	
Total Lost Time (s)	5.0	5.0		5.0	5.0			5.0		5.0	5.0	
Lead/Lag							Lead				Lag	
Lead-Lag Optimize?												
Vehicle Extension (s)	3.0	3.0		3.0	3.0		3.0	2.0		2.0	2.0	
Recall Mode	C-Max	C-Max		C-Max	C-Max		None	None		None	None	
Walk Time (s)								7.0		7.0	7.0	
Flash Dont Walk (s)								16.0		16.0	15.0	
Pedestrian Calls (#/hr)								0		0	0	
Act Effect Green (s)	77.2	77.2		77.2	77.2			42.8		42.8	42.8	

Lanes, Volumes, Timings

11: Raleigh Street/Hillsborough Street & E. Franklin Street

09/01/2020



Lane Group	EBL	EBT	EBR	WBL	WBT	WBR	NBL	NBT	NBR	SBL	SBT	SBR
Actuated g/C Ratio	0.59	0.59		0.59	0.59			0.33		0.33	0.33	
v/c Ratio	0.16	0.31		0.11	0.32			0.75		0.31	0.46	
Control Delay	15.4	12.8		16.0	15.5			49.3		30.1	33.6	
Queue Delay	0.0	0.0		0.0	0.0			0.0		0.0	4.0	
Total Delay	15.4	12.8		16.0	15.5			49.3		30.1	37.7	
LOS	B	B		B	B			D		C	D	
Approach Delay		13.0			15.5			49.3			35.8	
Approach LOS		B			B			D			D	
Queue Length 50th (ft)	13	66		16	122			218		49	155	
Queue Length 95th (ft)	57	171		46	206			276		80	198	
Internal Link Dist (ft)		1120			933			915			283	
Turn Bay Length (ft)	75			75						100		
Base Capacity (vph)	376	1717		415	1836			598		410	555	
Starvation Cap Reductn	0	0		0	0			0		0	228	
Spillback Cap Reductn	0	0		0	0			0		0	0	
Storage Cap Reductn	0	0		0	0			0		0	0	
Reduced v/c Ratio	0.16	0.31		0.11	0.32			0.49		0.20	0.75	

Intersection Summary





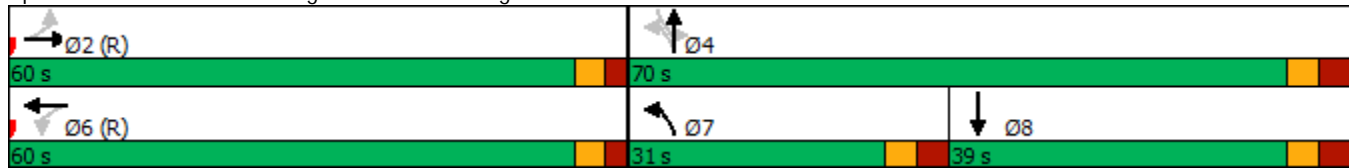













Area Type:	Other
Cycle Length:	130
Actuated Cycle Length:	130
Offset:	57 (44%), Referenced to phase 2:EBTL and 6:WBTL, Start of Green
Natural Cycle:	60
Control Type:	Actuated-Coordinated
Maximum v/c Ratio:	0.75
Intersection Signal Delay:	23.7
Intersection LOS:	C
Intersection Capacity Utilization:	77.3%
ICU Level of Service:	D
Analysis Period (min):	15

Splits and Phases: 11: Raleigh Street/Hillsborough Street & E. Franklin Street



Lanes, Volumes, Timings

13: NC 86 (N. Columbia St)/NC 86 (MLK Jr. Blvd) & North Street & N. Columbia Street 09/01/2020

												
Lane Group	WBL	WBR	WBR2	NBL	NBT	NBR	SBL	SBT	SBR	SEL2	SEL	SER
Lane Configurations												
Traffic Volume (vph)	8	9	85	44	470	4	63	533	6	1	7	60
Future Volume (vph)	8	9	85	44	470	4	63	533	6	1	7	60
Ideal Flow (vphpl)	1900	1900	1900	1900	1900	1900	1900	1900	1900	1900	1900	1900
Grade (%)	2%				-5%			5%				-3%
Storage Length (ft)	0	0		150		0	70		0		0	0
Storage Lanes	1	0		1		0	1		0		1	0
Taper Length (ft)	25			25			25				25	
Lane Util. Factor	1.00	1.00	1.00	1.00	0.95	0.95	1.00	0.95	0.95	1.00	1.00	1.00
Ped Bike Factor	0.98			1.00	1.00		0.98	1.00			1.00	
Frt	0.876				0.999			0.998				0.880
Flt Protected	0.996			0.950			0.950				0.994	
Satd. Flow (prot)	1578	0	0	1729	3453	0	1676	3344	0	0	1562	0
Flt Permitted	0.996			0.388			0.445				0.994	
Satd. Flow (perm)	1578	0	0	704	3453	0	768	3344	0	0	1560	0
Right Turn on Red			No			No			No			No
Satd. Flow (RTOR)												
Link Speed (mph)	20				35			35				25
Link Distance (ft)	264				476			2108				715
Travel Time (s)	9.0				9.3			41.1				19.5
Confl. Peds. (#/hr)			8	6		41	41		6	8		
Peak Hour Factor	0.75	0.75	0.75	0.93	0.93	0.93	0.87	0.87	0.87	0.75	0.75	0.75
Heavy Vehicles (%)	2%	2%	2%	7%	7%	7%	5%	5%	5%	8%	8%	8%
Adj. Flow (vph)	11	12	113	47	505	4	72	613	7	1	9	80
Shared Lane Traffic (%)												
Lane Group Flow (vph)	136	0	0	47	509	0	72	620	0	0	90	0
Turn Type	Prot			Perm	NA		Perm	NA		Prot	Prot	
Protected Phases	3				2			6		4	4	
Permitted Phases				2			6					
Detector Phase	3			2	2		6	6		4	4	
Switch Phase												
Minimum Initial (s)	7.0			10.0	10.0		10.0	10.0		7.0	7.0	
Minimum Split (s)	14.0			17.0	17.0		17.0	17.0		14.0	14.0	
Total Split (s)	39.0			61.0	61.0		61.0	61.0		30.0	30.0	
Total Split (%)	30.0%			46.9%	46.9%		46.9%	46.9%		23.1%	23.1%	
Maximum Green (s)	32.0			54.0	54.0		54.0	54.0		23.0	23.0	
Yellow Time (s)	5.0			5.0	5.0		5.0	5.0		5.0	5.0	
All-Red Time (s)	2.0			2.0	2.0		2.0	2.0		2.0	2.0	
Lost Time Adjust (s)	-2.0			-2.0	-2.0		-2.0	-2.0			-2.0	
Total Lost Time (s)	5.0			5.0	5.0		5.0	5.0			5.0	
Lead/Lag	Lead									Lag	Lag	
Lead-Lag Optimize?	Yes									Yes	Yes	
Vehicle Extension (s)	3.0			3.0	3.0		3.0	3.0		3.0	3.0	
Recall Mode	None			C-Max	C-Max		C-Max	C-Max		None	None	
Act Effct Green (s)	18.5			81.7	81.7		81.7	81.7			14.8	
Actuated g/C Ratio	0.14			0.63	0.63		0.63	0.63			0.11	
v/c Ratio	0.60			0.11	0.23		0.15	0.30			0.51	
Control Delay	63.0			11.3	9.7		13.1	12.6			63.3	
Queue Delay	0.0			0.0	0.0		0.0	0.0			0.0	

Lanes, Volumes, Timings

13: NC 86 (N. Columbia St)/NC 86 (MLK Jr. Blvd) & North Street & N. Columbia Street 09/01/2020



Lane Group	WBL	WBR	WBR2	NBL	NBT	NBR	SBL	SBT	SBR	SEL2	SEL	SER
Total Delay	63.0			11.3	9.7		13.1	12.6			63.3	
LOS	E			B	A		B	B			E	
Approach Delay	63.0				9.9			12.7			63.3	
Approach LOS	E				A			B			E	
Queue Length 50th (ft)	109			11	69		23	117			72	
Queue Length 95th (ft)	138			m27	101		56	183			102	
Internal Link Dist (ft)	184				396			2028			635	
Turn Bay Length (ft)				150			70					
Base Capacity (vph)	412			442	2169		482	2100			300	
Starvation Cap Reductn	0			0	0		0	0			0	
Spillback Cap Reductn	0			0	0		0	0			0	
Storage Cap Reductn	0			0	0		0	0			0	
Reduced v/c Ratio	0.33			0.11	0.23		0.15	0.30			0.30	

Intersection Summary

Area Type: Other
 Cycle Length: 130
 Actuated Cycle Length: 130
 Offset: 67 (52%), Referenced to phase 2:NBTL and 6:SBTL, Start of Green
 Natural Cycle: 45
 Control Type: Actuated-Coordinated
 Maximum v/c Ratio: 0.60
 Intersection Signal Delay: 19.4 Intersection LOS: B
 Intersection Capacity Utilization 52.8% ICU Level of Service A
 Analysis Period (min) 15
 m Volume for 95th percentile queue is metered by upstream signal.

Splits and Phases: 13: NC 86 (N. Columbia St)/NC 86 (MLK Jr. Blvd) & North Street & N. Columbia Street

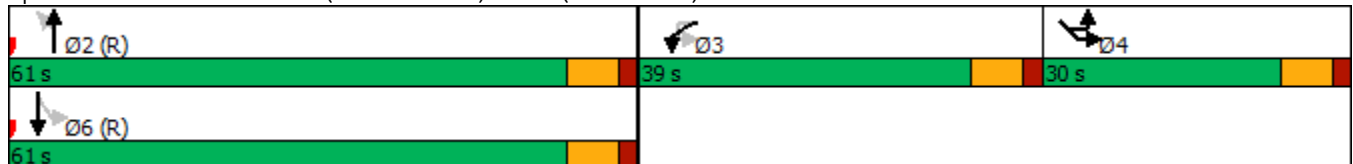

Lanes, Volumes, Timings

14: NC 86 (MLK Jr. Blvd) & Longview Street/Mill Creek Apts Driveway

09/01/2020



Lane Group	EBL	EBT	EBR	WBL	WBT	WBR	NBL	NBT	NBR	SBL	SBT	SBR
Lane Configurations		↕			↕		↕	↕		↕	↕	
Traffic Volume (vph)	37	0	19	4	0	2	7	525	8	1	578	35
Future Volume (vph)	37	0	19	4	0	2	7	525	8	1	578	35
Ideal Flow (vphpl)	1900	1900	1900	1900	1900	1900	1900	1900	1900	1900	1900	1900
Grade (%)		-6%			1%			2%			-4%	
Storage Length (ft)	0		0	0		0	225		0	250		0
Storage Lanes	0		0	0		0	1		0	1		0
Taper Length (ft)	25			25			25			25		
Lane Util. Factor	1.00	1.00	1.00	1.00	1.00	1.00	1.00	0.95	0.95	1.00	0.95	0.95
Ped Bike Factor		0.99			0.98		0.99	1.00		0.98	1.00	
Frt		0.954			0.955			0.998			0.992	
Flt Protected		0.968			0.968		0.950			0.950		
Satd. Flow (prot)	0	1720	0	0	1706	0	1670	3331	0	1753	3472	0
Flt Permitted		0.794			0.754		0.396			0.426		
Satd. Flow (perm)	0	1410	0	0	1314	0	692	3331	0	774	3472	0
Right Turn on Red			No			No			No			No
Satd. Flow (RTOR)												
Link Speed (mph)		25			20			35			35	
Link Distance (ft)		451			338			2108			784	
Travel Time (s)		12.3			11.5			41.1			15.3	
Confl. Peds. (#/hr)	1		19	19		1	7		15	15		7
Peak Hour Factor	0.76	0.76	0.76	0.50	0.50	0.50	0.89	0.89	0.89	0.91	0.91	0.91
Heavy Vehicles (%)	4%	4%	4%	2%	2%	2%	7%	7%	7%	5%	5%	5%
Adj. Flow (vph)	49	0	25	8	0	4	8	590	9	1	635	38
Shared Lane Traffic (%)												
Lane Group Flow (vph)	0	74	0	0	12	0	8	599	0	1	673	0
Turn Type	Perm	NA		Perm	NA		Perm	NA		Perm	NA	
Protected Phases		4			8			2			6	
Permitted Phases	4			8			2			6		
Detector Phase	4	4		8	8		2	2		6	6	
Switch Phase												
Minimum Initial (s)	7.0	7.0		7.0	7.0		12.0	12.0		12.0	12.0	
Minimum Split (s)	31.0	31.0		14.0	14.0		28.0	28.0		28.0	28.0	
Total Split (s)	20.0	20.0		20.0	20.0		60.0	60.0		60.0	60.0	
Total Split (%)	25.0%	25.0%		25.0%	25.0%		75.0%	75.0%		75.0%	75.0%	
Maximum Green (s)	14.0	14.0		13.9	13.9		54.0	54.0		54.5	54.5	
Yellow Time (s)	3.5	3.5		3.0	3.0		4.5	4.5		4.0	4.0	
All-Red Time (s)	2.5	2.5		3.1	3.1		1.5	1.5		1.5	1.5	
Lost Time Adjust (s)		-1.0			-1.0		-1.0	-1.0		-0.5	-0.5	
Total Lost Time (s)		5.0			5.1		5.0	5.0		5.0	5.0	
Lead/Lag												
Lead-Lag Optimize?												
Vehicle Extension (s)	3.0	3.0		3.0	3.0		3.0	3.0		3.0	3.0	
Recall Mode	None	None		None	None		Min	Min		Min	Min	
Walk Time (s)	7.0	7.0					7.0	7.0		7.0	7.0	
Flash Dont Walk (s)	17.0	17.0					9.0	9.0		9.0	9.0	
Pedestrian Calls (#/hr)	0	0					0	0		0	0	
Act Effct Green (s)		8.7			8.6		24.6	24.6		24.6	24.6	
Actuated g/C Ratio		0.24			0.24		0.69	0.69		0.69	0.69	

Lanes, Volumes, Timings

14: NC 86 (MLK Jr. Blvd) & Longview Street/Mill Creek Apts Driveway

09/01/2020



Lane Group	EBL	EBT	EBR	WBL	WBT	WBR	NBL	NBT	NBR	SBL	SBT	SBR
v/c Ratio		0.22			0.04		0.02	0.26		0.00	0.28	
Control Delay		12.8			11.0		5.4	5.1		5.0	5.1	
Queue Delay		0.0			0.0		0.0	0.0		0.0	0.0	
Total Delay		12.8			11.0		5.4	5.1		5.0	5.1	
LOS		B			B		A	A		A	A	
Approach Delay		12.8			11.0			5.1			5.1	
Approach LOS		B			B			A			A	
Queue Length 50th (ft)		14			2		1	33		0	37	
Queue Length 95th (ft)		28			5		5	61		2	70	
Internal Link Dist (ft)		371			258			2028			704	
Turn Bay Length (ft)							225			250		
Base Capacity (vph)		597			553		692	3331		774	3472	
Starvation Cap Reductn		0			0		0	0		0	0	
Spillback Cap Reductn		0			0		0	0		0	0	
Storage Cap Reductn		0			0		0	0		0	0	
Reduced v/c Ratio		0.12			0.02		0.01	0.18		0.00	0.19	

Intersection Summary

Area Type:	Other
Cycle Length:	80
Actuated Cycle Length:	35.6
Natural Cycle:	60
Control Type:	Actuated-Uncoordinated
Maximum v/c Ratio:	0.28
Intersection Signal Delay:	5.6
Intersection LOS:	A
Intersection Capacity Utilization:	37.9%
ICU Level of Service:	A
Analysis Period (min):	15

Splits and Phases: 14: NC 86 (MLK Jr. Blvd) & Longview Street/Mill Creek Apts Driveway



Lanes, Volumes, Timings
 15: NC 86 (Pittsboro St) & W. Cameron Avenue

09/01/2020



Lane Group	EBT	EBR	WBL	WBT	NBL	NBR	Ø1	Ø4
Lane Configurations	↻		↻↻	↻				
Traffic Volume (vph)	80	154	463	218	0	0		
Future Volume (vph)	80	154	463	218	0	0		
Ideal Flow (vphpl)	1900	1900	1900	1900	1900	1900		
Lane Width (ft)	12	12	11	12	12	12		
Grade (%)	3%			-3%	0%			
Storage Length (ft)		0	75		0	0		
Storage Lanes		0	0		0	0		
Taper Length (ft)			25		25			
Lane Util. Factor	1.00	1.00	0.97	1.00	1.00	1.00		
Ped Bike Factor	0.78		0.65					
Frt	0.911							
Flt Protected			0.950					
Satd. Flow (prot)	1171	0	2837	1592	0	0		
Flt Permitted			0.950					
Satd. Flow (perm)	1171	0	1846	1592	0	0		
Right Turn on Red		No				No		
Satd. Flow (RTOR)								
Link Speed (mph)	25			25	25			
Link Distance (ft)	391			120	794			
Travel Time (s)	30.0			10.7	21.7			
Confl. Peds. (#/hr)		129	129					
Peak Hour Factor	0.71	0.71	0.93	0.93	0.90	0.90		
Heavy Vehicles (%)	2%	2%	9%	9%	2%	2%		
Adj. Flow (vph)	113	217	498	234	0	0		
Shared Lane Traffic (%)								
Lane Group Flow (vph)	330	0	498	234	0	0		
Turn Type	NA		Prot	NA				
Protected Phases	2		1 4	6			1	4
Permitted Phases								
Detector Phase	2		1 4	6				
Switch Phase								
Minimum Initial (s)	10.0			10.0			7.0	7.0
Minimum Split (s)	20.0			20.0			20.0	20.0
Total Split (s)	77.0			110.0			33.0	20.0
Total Split (%)	59.2%			84.6%			25%	15%
Maximum Green (s)	71.9			105.0			27.9	16.0
Yellow Time (s)	3.0			3.3			3.0	3.0
All-Red Time (s)	2.1			1.7			2.1	1.0
Lost Time Adjust (s)	-0.1			0.0				
Total Lost Time (s)	5.0			5.0				
Lead/Lag	Lag						Lead	
Lead-Lag Optimize?								
Vehicle Extension (s)	1.0			1.0			4.0	0.2
Recall Mode	None			C-Max			C-Max	None
Walk Time (s)	7.0							7.0
Flash Dont Walk (s)	4.0							9.0
Pedestrian Calls (#/hr)	0							0
Act Effect Green (s)	72.0		48.0	105.4				

Lanes, Volumes, Timings
 15: NC 86 (Pittsboro St) & W. Cameron Avenue

09/01/2020



Lane Group	EBT	EBR	WBL	WBT	NBL	NBR	Ø1	Ø4
Actuated g/C Ratio	0.55		0.37	0.81				
v/c Ratio	0.51		0.48	0.18				
Control Delay	21.5		26.3	3.3				
Queue Delay	0.0		1.3	0.6				
Total Delay	21.5		27.7	3.9				
LOS	C		C	A				
Approach Delay	21.5			20.1				
Approach LOS	C			C				
Queue Length 50th (ft)	166		167	31				
Queue Length 95th (ft)	177		251	m64				
Internal Link Dist (ft)	311			40	714			
Turn Bay Length (ft)			75					
Base Capacity (vph)	648		1033	1290				
Starvation Cap Reductn	0		326	721				
Spillback Cap Reductn	0		0	0				
Storage Cap Reductn	0		0	0				
Reduced v/c Ratio	0.51		0.70	0.41				

Intersection Summary

Area Type: CBD
 Cycle Length: 130
 Actuated Cycle Length: 130
 Offset: 28 (22%), Referenced to phase 1:WBL and 6:WBT, Start of Green
 Natural Cycle: 65
 Control Type: Actuated-Coordinated
 Maximum v/c Ratio: 0.51
 Intersection Signal Delay: 20.5 Intersection LOS: C
 Intersection Capacity Utilization 42.6% ICU Level of Service A
 Analysis Period (min) 15
 m Volume for 95th percentile queue is metered by upstream signal.

Splits and Phases: 15: NC 86 (Pittsboro St) & W. Cameron Avenue

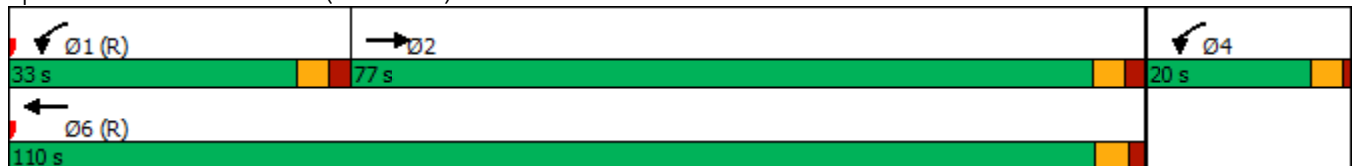

Lanes, Volumes, Timings

16: NC 86 (S. Columbia St) & W. Cameron Avenue/E. Cameron Avenue

09/01/2020



Lane Group	EBL	EBT	EBR	WBL	WBT	WBR	NBL	NBT	NBR	SBL	SBT	SBR
Lane Configurations												
Traffic Volume (vph)	21	52	0	0	91	37	171	398	27	43	0	418
Future Volume (vph)	21	52	0	0	91	37	171	398	27	43	0	418
Ideal Flow (vphp)	1900	1900	1900	1900	1900	1900	1900	1900	1900	1900	1900	1900
Lane Width (ft)	11	12	12	12	12	12	10	10	10	11	11	12
Grade (%)		1%			-1%			1%			2%	
Storage Length (ft)	100		0	0		0	0		0	310		0
Storage Lanes	1		0	0		0	1		0	1		2
Taper Length (ft)	25			25			25			25		
Lane Util. Factor	1.00	1.00	1.00	1.00	1.00	1.00	0.91	0.91	0.95	1.00	1.00	0.88
Ped Bike Factor	0.77				0.91		0.60	0.94		0.62		0.43
Frt					0.961			0.991				0.850
Flt Protected	0.950						0.950	0.998		0.950		
Satd. Flow (prot)	1488	1620	0	0	1404	0	1259	2499	0	1439	0	2345
Flt Permitted	0.487						0.950	0.998		0.950		
Satd. Flow (perm)	588	1620	0	0	1404	0	757	2460	0	891	0	1014
Right Turn on Red			No			No			No			No
Satd. Flow (RTOR)												
Link Speed (mph)		25			25			25			25	
Link Distance (ft)		273			989			826			981	
Travel Time (s)		10.7			57.6			22.5			26.8	
Confl. Peds. (#/hr)	207		358	358		207	244		349	349		244
Peak Hour Factor	0.93	0.93	0.93	0.84	0.84	0.84	0.86	0.86	0.86	0.86	0.86	0.86
Heavy Vehicles (%)	5%	5%	5%	7%	7%	7%	9%	9%	9%	8%	8%	8%
Adj. Flow (vph)	23	56	0	0	108	44	199	463	31	50	0	486
Shared Lane Traffic (%)							10%					
Lane Group Flow (vph)	23	56	0	0	152	0	179	514	0	50	0	486
Turn Type	Perm	NA			NA		Split	NA		Prot		Prot
Protected Phases		4			8		2	2		1		1
Permitted Phases	4									1		1
Detector Phase	4	4			8		2	2		1		1
Switch Phase												
Minimum Initial (s)	10.0	10.0			10.0		7.0	7.0		7.0		7.0
Minimum Split (s)	24.0	24.0			31.0		18.0	18.0		26.0		26.0
Total Split (s)	40.0	40.0			40.0		23.0	23.0		39.0		39.0
Total Split (%)	30.8%	30.8%			30.8%		17.7%	17.7%		30.0%		30.0%
Maximum Green (s)	33.8	33.8			33.8		17.1	17.1		33.4		33.4
Yellow Time (s)	3.2	3.2			3.2		3.1	3.1		3.0		3.0
All-Red Time (s)	3.0	3.0			3.0		2.8	2.8		2.6		2.6
Lost Time Adjust (s)	-1.2	-1.2			-1.2		-0.9	-0.9		-0.6		-0.6
Total Lost Time (s)	5.0	5.0			5.0		5.0	5.0		5.0		5.0
Lead/Lag							Lead	Lead		Lag		Lag
Lead-Lag Optimize?												
Vehicle Extension (s)	2.0	2.0			2.0		4.0	4.0		4.0		4.0
Recall Mode	None	None			None		C-Max	C-Max		None		None
Walk Time (s)	7.0	7.0			7.0		7.0	7.0		7.0		7.0
Flash Dont Walk (s)	10.0	10.0			17.0		5.0	5.0		13.0		13.0
Pedestrian Calls (#/hr)	0	0			0		0	0		0		0
Act Effect Green (s)	19.7	19.7			19.7		63.7	63.7		31.6		31.6

Lanes, Volumes, Timings

16: NC 86 (S. Columbia St) & W. Cameron Avenue/E. Cameron Avenue

09/01/2020

Lane Group	Ø9
Lane Configurations	
Traffic Volume (vph)	
Future Volume (vph)	
Ideal Flow (vphpl)	
Lane Width (ft)	
Grade (%)	
Storage Length (ft)	
Storage Lanes	
Taper Length (ft)	
Lane Util. Factor	
Ped Bike Factor	
Frt	
Flt Protected	
Satd. Flow (prot)	
Flt Permitted	
Satd. Flow (perm)	
Right Turn on Red	
Satd. Flow (RTOR)	
Link Speed (mph)	
Link Distance (ft)	
Travel Time (s)	
Confl. Peds. (#/hr)	
Peak Hour Factor	
Heavy Vehicles (%)	
Adj. Flow (vph)	
Shared Lane Traffic (%)	
Lane Group Flow (vph)	
Turn Type	
Protected Phases	9
Permitted Phases	
Detector Phase	
Switch Phase	
Minimum Initial (s)	7.0
Minimum Split (s)	28.0
Total Split (s)	28.0
Total Split (%)	22%
Maximum Green (s)	24.0
Yellow Time (s)	3.0
All-Red Time (s)	1.0
Lost Time Adjust (s)	
Total Lost Time (s)	
Lead/Lag	
Lead-Lag Optimize?	
Vehicle Extension (s)	0.2
Recall Mode	None
Walk Time (s)	7.0
Flash Dont Walk (s)	17.0
Pedestrian Calls (#/hr)	0
Act Effect Green (s)	

Lanes, Volumes, Timings

16: NC 86 (S. Columbia St) & W. Cameron Avenue/E. Cameron Avenue

09/01/2020



Lane Group	EBL	EBT	EBR	WBL	WBT	WBR	NBL	NBT	NBR	SBL	SBT	SBR
Actuated g/C Ratio	0.15	0.15			0.15		0.49	0.49		0.24		0.24
v/c Ratio	0.26	0.23			0.72		0.29	0.42		0.14		0.85
Control Delay	38.8	33.8			70.1		23.6	24.3		18.8		37.2
Queue Delay	0.0	0.0			0.0		0.0	0.0		0.0		0.0
Total Delay	38.8	33.8			70.1		23.6	24.3		18.8		37.2
LOS	D	C			E		C	C		B		D
Approach Delay		35.2			70.1			24.1				35.5
Approach LOS		D			E			C				D
Queue Length 50th (ft)	18	43			123		100	154		18		204
Queue Length 95th (ft)	m36	86			173		171	217		m33		264
Internal Link Dist (ft)		193			909			746				901
Turn Bay Length (ft)	100									310		
Base Capacity (vph)	158	436			378		616	1223		376		613
Starvation Cap Reductn	0	0			0		0	0		0		0
Spillback Cap Reductn	0	0			0		0	0		0		0
Storage Cap Reductn	0	0			0		0	0		0		0
Reduced v/c Ratio	0.15	0.13			0.40		0.29	0.42		0.13		0.79

Intersection Summary

Area Type: CBD
 Cycle Length: 130
 Actuated Cycle Length: 130
 Offset: 67 (52%), Referenced to phase 2:NBTL, Start of Green
 Natural Cycle: 105
 Control Type: Actuated-Coordinated
 Maximum v/c Ratio: 0.85
 Intersection Signal Delay: 33.7 Intersection LOS: C
 Intersection Capacity Utilization 69.8% ICU Level of Service C
 Analysis Period (min) 15
 m Volume for 95th percentile queue is metered by upstream signal.

Splits and Phases: 16: NC 86 (S. Columbia St) & W. Cameron Avenue/E. Cameron Avenue

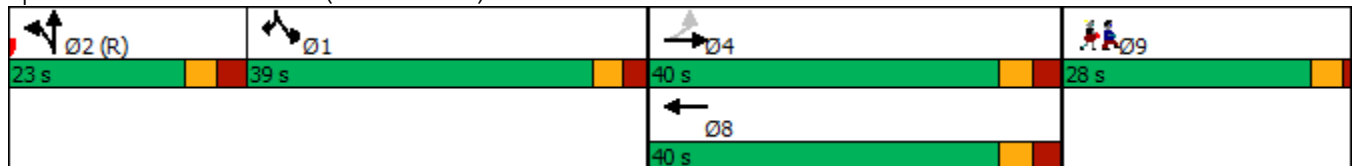

Lanes, Volumes, Timings

16: NC 86 (S. Columbia St) & W. Cameron Avenue/E. Cameron Avenue

09/01/2020

Lane Group	Ø9
Actuated g/C Ratio	
v/c Ratio	
Control Delay	
Queue Delay	
Total Delay	
LOS	
Approach Delay	
Approach LOS	
Queue Length 50th (ft)	
Queue Length 95th (ft)	
Internal Link Dist (ft)	
Turn Bay Length (ft)	
Base Capacity (vph)	
Starvation Cap Reductn	
Spillback Cap Reductn	
Storage Cap Reductn	
Reduced v/c Ratio	
Intersection Summary	

Lanes, Volumes, Timings

17: Raleigh Street & E. Cameron Avenue/Country Club Road

09/01/2020



Lane Group	EBL	EBT	EBR	WBL	WBT	WBR	NBL	NBT	NBR	SBL	SBT	SBR
Lane Configurations		↕		↖	↗		↖	↗		↖	↗	
Traffic Volume (vph)	31	65	33	21	87	172	33	77	28	240	112	44
Future Volume (vph)	31	65	33	21	87	172	33	77	28	240	112	44
Ideal Flow (vphpl)	1900	1900	1900	1900	1900	1900	1900	1900	1900	1900	1900	1900
Grade (%)		-3%			3%			-2%				1%
Storage Length (ft)	0		0	150		0	125		0	75		0
Storage Lanes	0		0	1		0	1		0	1		0
Taper Length (ft)	25			25			25			25		
Lane Util. Factor	1.00	1.00	1.00	1.00	1.00	1.00	1.00	1.00	1.00	1.00	1.00	1.00
Ped Bike Factor		0.91		0.90	0.87		0.67	0.95		0.87	0.85	
Frt		0.966			0.901			0.960			0.958	
Flt Protected		0.988		0.950			0.950			0.950		
Satd. Flow (prot)	0	1517	0	1569	1291	0	1505	1450	0	1554	1331	0
Flt Permitted		0.844		0.536			0.653			0.455		
Satd. Flow (perm)	0	1257	0	795	1291	0	698	1450	0	649	1331	0
Right Turn on Red			No			No			No			No
Satd. Flow (RTOR)												
Link Speed (mph)		25			25			25				25
Link Distance (ft)		598			651			409				995
Travel Time (s)		16.3			17.8			11.2				27.1
Confl. Peds. (#/hr)	38		43	43		38	103		33	33		103
Peak Hour Factor	0.87	0.87	0.87	0.91	0.91	0.91	0.93	0.93	0.93	0.95	0.95	0.95
Heavy Vehicles (%)	2%	2%	2%	2%	2%	2%	9%	9%	9%	4%	4%	4%
Adj. Flow (vph)	36	75	38	23	96	189	35	83	30	253	118	46
Shared Lane Traffic (%)												
Lane Group Flow (vph)	0	149	0	23	285	0	35	113	0	253	164	0
Turn Type	Perm	NA		pm+pt	NA		pm+pt	NA		pm+pt	NA	
Protected Phases		2		1	6		3	8		7	4	
Permitted Phases	2			6			8			4		
Detector Phase	2	2		1	6		3	8		7	4	
Switch Phase												
Minimum Initial (s)	10.0	10.0		7.0	10.0		7.0	7.0		7.0	7.0	
Minimum Split (s)	18.0	18.0		13.0	19.0		13.0	19.0		12.0	16.0	
Total Split (s)	50.0	50.0		20.0	70.0		20.0	35.0		20.0	35.0	
Total Split (%)	40.0%	40.0%		16.0%	56.0%		16.0%	28.0%		16.0%	28.0%	
Maximum Green (s)	43.9	43.9		14.4	64.4		14.7	29.7		15.1	29.9	
Yellow Time (s)	3.3	3.3		3.0	3.1		3.0	3.1		3.0	3.1	
All-Red Time (s)	2.8	2.8		2.6	2.5		2.3	2.2		1.9	2.0	
Lost Time Adjust (s)		-1.1		-0.6	-0.6		-0.3	-0.3		0.1	-0.1	
Total Lost Time (s)		5.0		5.0	5.0		5.0	5.0		5.0	5.0	
Lead/Lag	Lag	Lag		Lead			Lead	Lag		Lead	Lag	
Lead-Lag Optimize?	Yes	Yes		Yes			Yes	Yes		Yes	Yes	
Vehicle Extension (s)	2.0	2.0		2.0	2.0		2.0	2.0		2.0	2.0	
Recall Mode	None	None		None	None		None	None		None	None	
Walk Time (s)	4.0	4.0			4.0			4.0			4.0	
Flash Dont Walk (s)	7.0	7.0			9.0			9.0			6.0	
Pedestrian Calls (#/hr)	0	0			0			0			0	
Act Effect Green (s)		16.3		20.0	20.0		16.0	10.6		24.9	21.2	
Actuated g/C Ratio		0.29		0.36	0.36		0.28	0.19		0.44	0.38	

Lanes, Volumes, Timings

17: Raleigh Street & E. Cameron Avenue/Country Club Road

09/01/2020

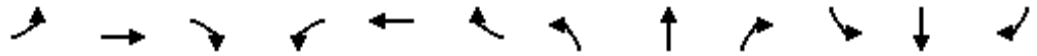

Lane Group	EBL	EBT	EBR	WBL	WBT	WBR	NBL	NBT	NBR	SBL	SBT	SBR
v/c Ratio		0.41		0.06	0.62		0.11	0.41		0.50	0.33	
Control Delay		25.4		13.7	23.2		12.5	30.2		15.1	19.1	
Queue Delay		0.0		0.0	0.0		0.0	0.0		0.0	0.0	
Total Delay		25.4		13.7	23.2		12.5	30.2		15.1	19.1	
LOS		C		B	C		B	C		B	B	
Approach Delay		25.4			22.5			26.0			16.7	
Approach LOS		C			C			C			B	
Queue Length 50th (ft)		40		6	86		5	35		45	28	
Queue Length 95th (ft)		111		19	172		25	96		131	119	
Internal Link Dist (ft)		518			571			329			915	
Turn Bay Length (ft)				150			125			75		
Base Capacity (vph)		996		544	1250		549	862		589	791	
Starvation Cap Reductn		0		0	0		0	0		0	0	
Spillback Cap Reductn		0		0	0		0	0		0	0	
Storage Cap Reductn		0		0	0		0	0		0	0	
Reduced v/c Ratio		0.15		0.04	0.23		0.06	0.13		0.43	0.21	

Intersection Summary

Area Type: CBD

Cycle Length: 125

Actuated Cycle Length: 56.2

Natural Cycle: 65

Control Type: Actuated-Uncoordinated

Maximum v/c Ratio: 0.62

Intersection Signal Delay: 21.0

Intersection LOS: C

Intersection Capacity Utilization 69.1%

ICU Level of Service C

Analysis Period (min) 15

Splits and Phases: 17: Raleigh Street & E. Cameron Avenue/Country Club Road



Lanes, Volumes, Timings
1: Church Street & W. Rosemary Street

09/01/2020



Lane Group	EBL	EBT	EBR	WBL	WBT	WBR	NBL	NBT	NBR	SBL	SBT	SBR
Lane Configurations		↕			↕			↕			↕	
Traffic Volume (vph)	24	428	66	65	451	37	47	80	65	24	76	26
Future Volume (vph)	24	428	66	65	451	37	47	80	65	24	76	26
Ideal Flow (vphpl)	1900	1900	1900	1900	1900	1900	1900	1900	1900	1900	1900	1900
Lane Width (ft)	12	14	12	12	14	12	12	12	12	12	12	12
Grade (%)		1%			-1%			0%			0%	
Lane Util. Factor	1.00	1.00	1.00	1.00	1.00	1.00	1.00	1.00	1.00	1.00	1.00	1.00
Ped Bike Factor		0.98			0.98			0.93			0.95	
Frt		0.983			0.991			0.955			0.972	
Flt Protected		0.998			0.994			0.988			0.991	
Satd. Flow (prot)	0	1710	0	0	1752	0	0	1515	0	0	1558	0
Flt Permitted		0.967			0.894			0.904			0.925	
Satd. Flow (perm)	0	1654	0	0	1568	0	0	1346	0	0	1436	0
Right Turn on Red			No			No			No			No
Satd. Flow (RTOR)												
Link Speed (mph)		20			20			25			25	
Link Distance (ft)		964			757			379			430	
Travel Time (s)		32.9			25.8			10.3			11.7	
Confl. Peds. (#/hr)	40		37	37		40	62		43	43		62
Peak Hour Factor	0.95	0.95	0.95	0.97	0.97	0.97	0.91	0.91	0.91	0.93	0.93	0.93
Adj. Flow (vph)	25	451	69	67	465	38	52	88	71	26	82	28
Shared Lane Traffic (%)												
Lane Group Flow (vph)	0	545	0	0	570	0	0	211	0	0	136	0
Turn Type	Perm	NA		Perm	NA		Perm	NA		Perm	NA	
Protected Phases		2			6			8			4	
Permitted Phases	2			6			8			4		
Detector Phase	2	2		6	6		8	8		4	4	
Switch Phase												
Minimum Initial (s)	10.0	10.0		10.0	10.0		7.0	7.0		7.0	7.0	
Minimum Split (s)	19.0	19.0		20.0	20.0		19.0	19.0		19.0	19.0	
Total Split (s)	45.0	45.0		45.0	45.0		25.0	25.0		25.0	25.0	
Total Split (%)	64.3%	64.3%		64.3%	64.3%		35.7%	35.7%		35.7%	35.7%	
Maximum Green (s)	40.5	40.5		40.4	40.4		20.1	20.1		20.1	20.1	
Yellow Time (s)	3.1	3.1		3.1	3.1		3.2	3.2		3.2	3.2	
All-Red Time (s)	1.4	1.4		1.5	1.5		1.7	1.7		1.7	1.7	
Lost Time Adjust (s)		0.5			0.4			0.1			0.1	
Total Lost Time (s)		5.0			5.0			5.0			5.0	
Lead/Lag												
Lead-Lag Optimize?												
Vehicle Extension (s)	3.0	3.0		3.0	3.0		3.0	3.0		3.0	3.0	
Recall Mode	C-Max	C-Max		C-Max	C-Max		None	None		None	None	
Walk Time (s)	4.0	4.0		4.0	4.0		4.0	4.0		4.0	4.0	
Flash Dont Walk (s)	5.0	5.0		6.0	6.0		10.0	10.0		10.0	10.0	
Pedestrian Calls (#/hr)	0	0		0	0		0	0		0	0	
Act Effct Green (s)		44.5			44.5			15.5			15.5	
Actuated g/C Ratio		0.64			0.64			0.22			0.22	
v/c Ratio		0.52			0.57			0.71			0.43	
Control Delay		10.1			5.3			37.0			26.6	
Queue Delay		0.0			0.0			0.0			0.0	

Lanes, Volumes, Timings
 1: Church Street & W. Rosemary Street

09/01/2020



Lane Group	EBL	EBT	EBR	WBL	WBT	WBR	NBL	NBT	NBR	SBL	SBT	SBR
Total Delay		10.1			5.3			37.0			26.6	
LOS		B			A			D			C	
Approach Delay		10.1			5.3			37.0			26.6	
Approach LOS		B			A			D			C	
Queue Length 50th (ft)		114			68			72			50	
Queue Length 95th (ft)		222			m93			m94			91	
Internal Link Dist (ft)		884			677			299			350	
Turn Bay Length (ft)												
Base Capacity (vph)		1051			996			384			410	
Starvation Cap Reductn		0			0			0			0	
Spillback Cap Reductn		0			0			0			0	
Storage Cap Reductn		0			0			0			0	
Reduced v/c Ratio		0.52			0.57			0.55			0.33	

Intersection Summary

Area Type: CBD
 Cycle Length: 70
 Actuated Cycle Length: 70
 Offset: 25 (36%), Referenced to phase 2:EBTL and 6:WBTL, Start of Green
 Natural Cycle: 55
 Control Type: Actuated-Coordinated
 Maximum v/c Ratio: 0.71
 Intersection Signal Delay: 13.7
 Intersection LOS: B
 Intersection Capacity Utilization 83.6%
 ICU Level of Service E
 Analysis Period (min) 15
 m Volume for 95th percentile queue is metered by upstream signal.

Splits and Phases: 1: Church Street & W. Rosemary Street



Lanes, Volumes, Timings

2: NC 86 (N. Columbia St) & W. Rosemary Street/E. Rosemary Street

09/01/2020



Lane Group	EBL	EBT	EBR	WBL	WBT	WBR	NBL	NBT	NBR	SBL	SBT	SBR
Lane Configurations												
Traffic Volume (vph)	232	275	49	117	243	63	52	597	96	68	515	277
Future Volume (vph)	232	275	49	117	243	63	52	597	96	68	515	277
Ideal Flow (vphpl)	1900	1900	1900	1900	1900	1900	1900	1900	1900	1900	1900	1900
Lane Width (ft)	9	12	13	12	12	12	9	10	12	12	9	11
Grade (%)		1%			1%			-2%			8%	
Storage Length (ft)	100		0	150		0	75		0	150		400
Storage Lanes	1		0	1		0	1		0	1		1
Taper Length (ft)	25			25			25			25		
Lane Util. Factor	1.00	1.00	1.00	1.00	1.00	1.00	1.00	0.95	0.95	1.00	0.95	1.00
Ped Bike Factor	0.97	0.99		0.96	0.98		0.94	0.95				0.73
Frt		0.977			0.969			0.979				0.850
Flt Protected	0.950			0.950			0.950			0.950		
Satd. Flow (prot)	1426	1612	0	1585	1587	0	1420	2741	0	1514	2725	1310
Flt Permitted	0.126			0.542			0.350			0.236		
Satd. Flow (perm)	184	1612	0	871	1587	0	490	2741	0	376	2725	952
Right Turn on Red			No			No			No			No
Satd. Flow (RTOR)												
Link Speed (mph)		20			20			25			25	
Link Distance (ft)		757			461			353			476	
Travel Time (s)		25.8			15.7			9.6			13.0	
Confl. Peds. (#/hr)	49		36	36		49	59		83	83		59
Peak Hour Factor	0.88	0.88	0.88	0.94	0.94	0.94	0.83	0.83	0.83	0.82	0.82	0.82
Heavy Vehicles (%)	2%	2%	2%	2%	2%	2%	4%	4%	4%	3%	3%	3%
Adj. Flow (vph)	264	313	56	124	259	67	63	719	116	83	628	338
Shared Lane Traffic (%)												
Lane Group Flow (vph)	264	369	0	124	326	0	63	835	0	83	628	338
Turn Type	pm+pt	NA		Perm	NA		pm+pt	NA		pm+pt	NA	pm+ov
Protected Phases	7	4			8		5	2		1	6	7
Permitted Phases	4			8			2			6		6
Detector Phase	7	4		8	8		5	2		1	6	7
Switch Phase												
Minimum Initial (s)	7.0	7.0		7.0	7.0		7.0	10.0		7.0	10.0	7.0
Minimum Split (s)	13.0	31.0		32.0	32.0		13.0	23.0		13.0	22.0	13.0
Total Split (s)	24.0	56.0		32.0	32.0		20.0	64.0		20.0	64.0	24.0
Total Split (%)	17.1%	40.0%		22.9%	22.9%		14.3%	45.7%		14.3%	45.7%	17.1%
Maximum Green (s)	18.2	50.0		26.0	26.0		14.2	58.2		14.9	58.2	18.2
Yellow Time (s)	3.0	3.2		3.2	3.2		3.0	3.3		3.0	3.3	3.0
All-Red Time (s)	2.8	2.8		2.8	2.8		2.8	2.5		2.1	2.5	2.8
Lost Time Adjust (s)	-0.8	-1.0		-1.0	-1.0		-1.0	-0.8		-0.1	-0.8	-0.8
Total Lost Time (s)	5.0	5.0		5.0	5.0		4.8	5.0		5.0	5.0	5.0
Lead/Lag	Lead			Lag	Lag		Lead	Lag		Lead	Lag	Lead
Lead-Lag Optimize?												
Vehicle Extension (s)	1.0	1.0		1.0	1.0		1.0	3.0		1.0	3.0	1.0
Recall Mode	None	None		None	None		None	C-Max		None	C-Max	None
Walk Time (s)		7.0		7.0	7.0			7.0			7.0	
Flash Dont Walk (s)		18.0		19.0	19.0			10.0			9.0	
Pedestrian Calls (#/hr)		0		0	0			0			0	
Act Effect Green (s)	51.0	51.0		27.0	27.0		74.7	66.1		74.8	68.3	87.3

Lanes, Volumes, Timings

2: NC 86 (N. Columbia St) & W. Rosemary Street/E. Rosemary Street

09/01/2020

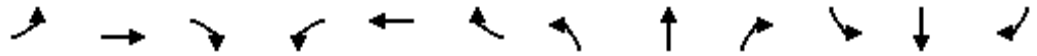

Lane Group	EBL	EBT	EBR	WBL	WBT	WBR	NBL	NBT	NBR	SBL	SBT	SBR
Actuated g/C Ratio	0.36	0.36		0.19	0.19		0.53	0.47		0.53	0.49	0.62
v/c Ratio	1.12	0.63		0.74	1.07		0.20	0.65		0.31	0.47	0.53
Control Delay	129.8	44.5		78.4	120.9		5.5	7.7		12.7	15.2	8.3
Queue Delay	0.0	0.0		0.0	0.0		0.0	3.6		0.0	0.2	0.0
Total Delay	129.8	44.5		78.4	120.9		5.5	11.4		12.7	15.4	8.3
LOS	F	D		E	F		A	B		B	B	A
Approach Delay		80.1			109.2			11.0			12.9	
Approach LOS		F			F			B			B	
Queue Length 50th (ft)	~238	298		103	~330		7	51		19	110	50
Queue Length 95th (ft)	#399	412		#211	#525		m7	m51		m29	106	45
Internal Link Dist (ft)		677			381			273			396	
Turn Bay Length (ft)	100			150			75			150		400
Base Capacity (vph)	235	587		167	306		378	1294		334	1330	642
Starvation Cap Reductn	0	0		0	0		0	358		0	166	0
Spillback Cap Reductn	0	0		0	0		0	0		0	103	0
Storage Cap Reductn	0	0		0	0		0	0		0	0	0
Reduced v/c Ratio	1.12	0.63		0.74	1.07		0.17	0.89		0.25	0.54	0.53

Intersection Summary

Area Type: CBD
 Cycle Length: 140
 Actuated Cycle Length: 140
 Offset: 62 (44%), Referenced to phase 2:NBTL and 6:SBTL, Start of Green
 Natural Cycle: 85
 Control Type: Actuated-Coordinated
 Maximum v/c Ratio: 1.12
 Intersection Signal Delay: 40.7 Intersection LOS: D
 Intersection Capacity Utilization 80.5% ICU Level of Service D
 Analysis Period (min) 15
 ~ Volume exceeds capacity, queue is theoretically infinite.
 Queue shown is maximum after two cycles.
 # 95th percentile volume exceeds capacity, queue may be longer.
 Queue shown is maximum after two cycles.
 m Volume for 95th percentile queue is metered by upstream signal.

Splits and Phases: 2: NC 86 (N. Columbia St) & W. Rosemary Street/E. Rosemary Street

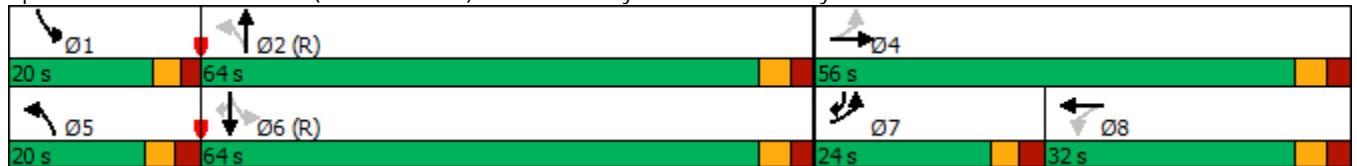

Lanes, Volumes, Timings

6: Henderson Street & E. Rosemary Street

09/01/2020



Lane Group	EBL	EBT	EBR	WBL	WBT	WBR	NBL	NBT	NBR	SBL	SBT	SBR
Lane Configurations												
Traffic Volume (vph)	43	294	155	12	201	58	67	24	5	23	57	10
Future Volume (vph)	43	294	155	12	201	58	67	24	5	23	57	10
Ideal Flow (vphpl)	1900	1900	1900	1900	1900	1900	1900	1900	1900	1900	1900	1900
Grade (%)		0%			0%			0%			3%	
Storage Length (ft)	85		0	0		0	0		0	0		0
Storage Lanes	1		0	0		0	0		0	0		0
Taper Length (ft)	25			25			25			25		
Lane Util. Factor	1.00	1.00	1.00	1.00	1.00	1.00	1.00	1.00	1.00	1.00	1.00	1.00
Ped Bike Factor	0.98	0.96			0.99			0.88			0.95	
Frt		0.948			0.971			0.993			0.985	
Flt Protected	0.950				0.998			0.966			0.987	
Satd. Flow (prot)	1593	1520	0	0	1603	0	0	1596	0	0	1566	0
Flt Permitted	0.613				0.977			0.757			0.908	
Satd. Flow (perm)	1006	1520	0	0	1569	0	0	1104	0	0	1401	0
Right Turn on Red			No			No			No			No
Satd. Flow (RTOR)												
Link Speed (mph)		20			20			20			20	
Link Distance (ft)		247			1195			366			450	
Travel Time (s)		8.4			40.7			12.5			15.3	
Confl. Peds. (#/hr)	14		34	34		14	73		51	51		73
Peak Hour Factor	0.90	0.90	0.90	0.93	0.93	0.93	0.67	0.67	0.67	0.79	0.79	0.79
Adj. Flow (vph)	48	327	172	13	216	62	100	36	7	29	72	13
Shared Lane Traffic (%)												
Lane Group Flow (vph)	48	499	0	0	291	0	0	143	0	0	114	0
Turn Type	Perm	NA		Perm	NA		Perm	NA		Perm	NA	
Protected Phases		2			2			4			4	
Permitted Phases	2			2			4			4		
Detector Phase	2	2		2	2		4	4		4	4	
Switch Phase												
Minimum Initial (s)	11.0	11.0		11.0	11.0		8.0	8.0		8.0	8.0	
Minimum Split (s)	15.9	15.9		15.9	15.9		17.8	17.8		17.8	17.8	
Total Split (s)	32.0	32.0		32.0	32.0		38.0	38.0		38.0	38.0	
Total Split (%)	45.7%	45.7%		45.7%	45.7%		54.3%	54.3%		54.3%	54.3%	
Maximum Green (s)	27.1	27.1		27.1	27.1		33.2	33.2		33.2	33.2	
Yellow Time (s)	3.3	3.3		3.3	3.3		3.3	3.3		3.3	3.3	
All-Red Time (s)	1.6	1.6		1.6	1.6		1.5	1.5		1.5	1.5	
Lost Time Adjust (s)	0.1	0.0			0.1			0.2			0.2	
Total Lost Time (s)	5.0	4.9			5.0			5.0			5.0	
Lead/Lag												
Lead-Lag Optimize?												
Vehicle Extension (s)	2.0	2.0		2.0	2.0		2.0	2.0		2.0	2.0	
Recall Mode	C-Max	C-Max		C-Max	C-Max		None	None		None	None	
Walk Time (s)	4.0	4.0		4.0	4.0		4.0	4.0		4.0	4.0	
Flash Dont Walk (s)	7.0	7.0		7.0	7.0		9.0	9.0		9.0	9.0	
Pedestrian Calls (#/hr)	0	0		0	0		0	0		0	0	
Act Effct Green (s)	46.0	46.1			46.0			14.0			14.0	
Actuated g/C Ratio	0.66	0.66			0.66			0.20			0.20	
v/c Ratio	0.07	0.50			0.28			0.65			0.41	

Lanes, Volumes, Timings
 6: Henderson Street & E. Rosemary Street

09/01/2020



Lane Group	EBL	EBT	EBR	WBL	WBT	WBR	NBL	NBT	NBR	SBL	SBT	SBR
Control Delay	7.1	9.0			5.9			29.3			27.0	
Queue Delay	0.0	0.0			0.0			0.0			0.0	
Total Delay	7.1	9.0			5.9			29.3			27.0	
LOS	A	A			A			C			C	
Approach Delay		8.8			5.9			29.3			27.0	
Approach LOS		A			A			C			C	
Queue Length 50th (ft)	6	86			58			53			44	
Queue Length 95th (ft)	m22	196			118			40			65	
Internal Link Dist (ft)		167			1115			286			370	
Turn Bay Length (ft)	85											
Base Capacity (vph)	660	1000			1030			520			660	
Starvation Cap Reductn	0	0			0			0			0	
Spillback Cap Reductn	0	0			0			0			0	
Storage Cap Reductn	0	0			0			0			0	
Reduced v/c Ratio	0.07	0.50			0.28			0.28			0.17	

Intersection Summary

Area Type: CBD
 Cycle Length: 70
 Actuated Cycle Length: 70
 Offset: 14 (20%), Referenced to phase 2:EBWB, Start of Green
 Natural Cycle: 50
 Control Type: Actuated-Coordinated
 Maximum v/c Ratio: 0.65
 Intersection Signal Delay: 12.6
 Intersection LOS: B
 Intersection Capacity Utilization 49.7%
 ICU Level of Service A
 Analysis Period (min) 15
 m Volume for 95th percentile queue is metered by upstream signal.

Splits and Phases: 6: Henderson Street & E. Rosemary Street

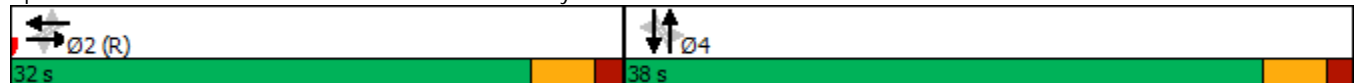

Lanes, Volumes, Timings

7: Hillsborough Street & E. Rosemary Street

09/01/2020



Lane Group	EBL	EBT	EBR	WBL	WBT	WBR	NBL	NBT	NBR	SBL	SBT	SBR
Lane Configurations		↕			↕		↗	↘		↗	↘	
Traffic Volume (vph)	44	136	79	10	100	57	167	298	23	37	205	28
Future Volume (vph)	44	136	79	10	100	57	167	298	23	37	205	28
Ideal Flow (vphpl)	1900	1900	1900	1900	1900	1900	1900	1900	1900	1900	1900	1900
Storage Length (ft)	0		0	0		0	100		0	100		0
Storage Lanes	0		0	0		0	1		0	1		0
Taper Length (ft)	25			25			25			25		
Lane Util. Factor	1.00	1.00	1.00	1.00	1.00	1.00	1.00	1.00	1.00	1.00	1.00	1.00
Ped Bike Factor		0.98			0.97		0.92	1.00		0.98	0.98	
Frt		0.959			0.954			0.989			0.982	
Flt Protected		0.992			0.997		0.950			0.950		
Satd. Flow (prot)	0	1744	0	0	1713	0	1770	1836	0	1770	1786	0
Flt Permitted		0.911			0.976		0.497			0.552		
Satd. Flow (perm)	0	1588	0	0	1675	0	852	1836	0	1008	1786	0
Right Turn on Red			No			No			No			No
Satd. Flow (RTOR)												
Link Speed (mph)		20			20			25			25	
Link Distance (ft)		1195			527			363			726	
Travel Time (s)		40.7			18.0			9.9			19.8	
Confl. Peds. (#/hr)	27		14	14		27	52		9	9		52
Peak Hour Factor	0.86	0.86	0.86	0.79	0.79	0.79	0.92	0.92	0.92	0.96	0.96	0.96
Adj. Flow (vph)	51	158	92	13	127	72	182	324	25	39	214	29
Shared Lane Traffic (%)												
Lane Group Flow (vph)	0	301	0	0	212	0	182	349	0	39	243	0
Turn Type	Perm	NA		Perm	NA		pm+pt	NA		Perm	NA	
Protected Phases		4			8		5	2			6	
Permitted Phases	4			8			2			6		
Detector Phase	4	4		8	8		5	2		6	6	
Switch Phase												
Minimum Initial (s)	7.0	7.0		7.0	7.0		7.0	10.0		10.0	10.0	
Minimum Split (s)	20.0	20.0		17.0	17.0		12.0	15.0		15.0	15.0	
Total Split (s)	30.0	30.0		30.0	30.0		14.0	40.0		26.0	26.0	
Total Split (%)	42.9%	42.9%		42.9%	42.9%		20.0%	57.1%		37.1%	37.1%	
Maximum Green (s)	25.1	25.1		25.0	25.0		9.2	35.2		21.2	21.2	
Yellow Time (s)	3.0	3.0		3.3	3.3		3.0	3.3		3.1	3.1	
All-Red Time (s)	1.9	1.9		1.7	1.7		1.8	1.5		1.7	1.7	
Lost Time Adjust (s)		0.1			0.0		0.2	0.2		0.2	0.2	
Total Lost Time (s)		5.0			5.0		5.0	5.0		5.0	5.0	
Lead/Lag							Lead			Lag	Lag	
Lead-Lag Optimize?												
Vehicle Extension (s)	2.0	2.0		2.0	2.0		2.0	2.0		2.0	2.0	
Recall Mode	None	None		None	None		None	C-Max		C-Max	C-Max	
Walk Time (s)	4.0	4.0		4.0	4.0			4.0		4.0	4.0	
Flash Dont Walk (s)	11.0	11.0		8.0	8.0			6.0		6.0	6.0	
Pedestrian Calls (#/hr)	0	0		0	0			0		0	0	
Act Effct Green (s)		17.6			17.6		42.4	42.4		29.6	29.6	
Actuated g/C Ratio		0.25			0.25		0.61	0.61		0.42	0.42	
v/c Ratio		0.76			0.50		0.29	0.31		0.09	0.32	
Control Delay		30.3			25.6		6.9	7.3		16.2	17.2	

Lanes, Volumes, Timings
 7: Hillsborough Street & E. Rosemary Street

09/01/2020



Lane Group	EBL	EBT	EBR	WBL	WBT	WBR	NBL	NBT	NBR	SBL	SBT	SBR
Queue Delay		0.0			0.0		0.0	0.3		0.0	0.0	
Total Delay		30.3			25.6		6.9	7.6		16.2	17.2	
LOS		C			C		A	A		B	B	
Approach Delay		30.3			25.6			7.3			17.0	
Approach LOS		C			C			A			B	
Queue Length 50th (ft)		117			78		35	85		10	66	
Queue Length 95th (ft)		121			101		71	152		34	146	
Internal Link Dist (ft)		1115			447			283			646	
Turn Bay Length (ft)							100			100		
Base Capacity (vph)		567			598		635	1112		426	754	
Starvation Cap Reductn		0			0		0	319		0	0	
Spillback Cap Reductn		0			0		0	0		0	0	
Storage Cap Reductn		0			0		0	0		0	0	
Reduced v/c Ratio		0.53			0.35		0.29	0.44		0.09	0.32	

Intersection Summary

Area Type:	Other
Cycle Length:	70
Actuated Cycle Length:	70
Offset:	32 (46%), Referenced to phase 2:NBTL and 6:SBTL, Start of Green
Natural Cycle:	50
Control Type:	Actuated-Coordinated
Maximum v/c Ratio:	0.76
Intersection Signal Delay:	17.5
Intersection LOS:	B
Intersection Capacity Utilization	65.9%
ICU Level of Service	C
Analysis Period (min)	15

Splits and Phases: 7: Hillsborough Street & E. Rosemary Street



Lanes, Volumes, Timings

8: Carolina Square Driveway/Church Street & W. Franklin Street

09/01/2020



Lane Group	EBL	EBT	EBR	WBL	WBT	WBR	NBL	NBT	NBR	SBL	SBT	SBR
Lane Configurations												
Traffic Volume (vph)	67	468	18	41	577	73	24	48	40	74	60	81
Future Volume (vph)	67	468	18	41	577	73	24	48	40	74	60	81
Ideal Flow (vphpl)	1900	1900	1900	1900	1900	1900	1900	1900	1900	1900	1900	1900
Lane Width (ft)	10	10	16	10	10	10	12	12	12	12	12	12
Grade (%)		2%			-2%			-4%				-3%
Storage Length (ft)	150		0	200		0	0		100	0		0
Storage Lanes	1		0	1		0	0		1	0		0
Taper Length (ft)	25			25			25			25		
Lane Util. Factor	1.00	1.00	1.00	1.00	1.00	1.00	1.00	1.00	1.00	1.00	1.00	1.00
Ped Bike Factor		0.99		0.88	0.96			0.94	0.88		0.86	
Frt		0.994			0.983				0.850		0.949	
Flt Protected	0.950			0.950				0.983			0.983	
Satd. Flow (prot)	1457	1504	0	1501	1493	0	0	1681	1454	0	1404	0
Flt Permitted	0.274			0.387				0.865			0.855	
Satd. Flow (perm)	420	1504	0	538	1493	0	0	1387	1282	0	1184	0
Right Turn on Red			No			No			No			No
Satd. Flow (RTOR)												
Link Speed (mph)		20			20			20			25	
Link Distance (ft)		993			294			285			379	
Travel Time (s)		33.9			10.0			9.7			10.3	
Confl. Peds. (#/hr)	124		164	164		124	175		63	63		175
Peak Hour Factor	0.91	0.91	0.91	0.93	0.93	0.93	0.81	0.81	0.81	0.91	0.91	0.91
Heavy Vehicles (%)	3%	3%	3%	2%	2%	2%	2%	2%	2%	2%	2%	2%
Adj. Flow (vph)	74	514	20	44	620	78	30	59	49	81	66	89
Shared Lane Traffic (%)												
Lane Group Flow (vph)	74	534	0	44	698	0	0	89	49	0	236	0
Turn Type	Perm	NA		Perm	NA		Perm	NA	Perm	Perm	NA	
Protected Phases		2			6			8				4
Permitted Phases	2			6			8		8	4		
Detector Phase	2	2		6	6		8	8	8	4	4	
Switch Phase												
Minimum Initial (s)	10.0	10.0		10.0	10.0		7.0	7.0	7.0	7.0	7.0	
Minimum Split (s)	22.0	22.0		19.0	19.0		29.0	29.0	29.0	27.0	27.0	
Total Split (s)	41.0	41.0		41.0	41.0		29.0	29.0	29.0	29.0	29.0	
Total Split (%)	58.6%	58.6%		58.6%	58.6%		41.4%	41.4%	41.4%	41.4%	41.4%	
Maximum Green (s)	35.4	35.4		35.4	35.4		22.7	22.7	22.7	23.0	23.0	
Yellow Time (s)	3.3	3.3		3.3	3.3		3.1	3.1	3.1	3.4	3.4	
All-Red Time (s)	2.3	2.3		2.3	2.3		3.2	3.2	3.2	2.6	2.6	
Lost Time Adjust (s)	-0.6	-0.6		-0.6	-0.6		-1.3	-1.3	-1.3		-1.0	
Total Lost Time (s)	5.0	5.0		5.0	5.0		5.0	5.0	5.0		5.0	
Lead/Lag												
Lead-Lag Optimize?												
Vehicle Extension (s)	3.0	3.0		3.0	3.0		2.0	2.0	2.0	2.0	2.0	
Recall Mode	C-Max	C-Max		C-Max	C-Max		None	None	None	None	None	
Walk Time (s)	7.0	7.0		7.0	7.0		7.0	7.0	7.0	7.0	7.0	
Flash Dont Walk (s)	9.0	9.0		6.0	6.0		15.0	15.0	15.0	14.0	14.0	
Pedestrian Calls (#/hr)	0	0		0	0		0	0	0	0	0	
Act Effect Green (s)	41.5	41.5		41.5	41.5		18.5	18.5	18.5		18.5	

Lanes, Volumes, Timings

8: Carolina Square Driveway/Church Street & W. Franklin Street

09/01/2020



Lane Group	EBL	EBT	EBR	WBL	WBT	WBR	NBL	NBT	NBR	SBL	SBT	SBR
Actuated g/C Ratio	0.59	0.59		0.59	0.59			0.26	0.26		0.26	
v/c Ratio	0.30	0.60		0.14	0.79			0.24	0.14		0.76	
Control Delay	13.2	14.0		10.1	18.1			20.1	18.6		36.6	
Queue Delay	0.0	0.0		0.0	0.0			0.0	0.0		0.0	
Total Delay	13.2	14.0		10.1	18.1			20.1	18.6		36.6	
LOS	B	B		B	B			C	B		D	
Approach Delay		13.9			17.7			19.5			36.6	
Approach LOS		B			B			B			D	
Queue Length 50th (ft)	14	134		15	331			30	16		104	
Queue Length 95th (ft)	49	274		m18	m329			51	32		120	
Internal Link Dist (ft)		913			214			205			299	
Turn Bay Length (ft)	150			200					100			
Base Capacity (vph)	249	892		319	885			475	439		405	
Starvation Cap Reductn	0	0		0	0			0	0		0	
Spillback Cap Reductn	0	0		0	0			0	0		0	
Storage Cap Reductn	0	0		0	0			0	0		0	
Reduced v/c Ratio	0.30	0.60		0.14	0.79			0.19	0.11		0.58	

Intersection Summary

Area Type:	CBD
Cycle Length:	70
Actuated Cycle Length:	70
Offset:	66 (94%), Referenced to phase 2:EBTL and 6:WBTL, Start of Green
Natural Cycle:	70
Control Type:	Actuated-Coordinated
Maximum v/c Ratio:	0.79
Intersection Signal Delay:	19.1
Intersection LOS:	B
Intersection Capacity Utilization:	83.3%
ICU Level of Service:	E
Analysis Period (min):	15
m Volume for 95th percentile queue is metered by upstream signal.	

Splits and Phases: 8: Carolina Square Driveway/Church Street & W. Franklin Street

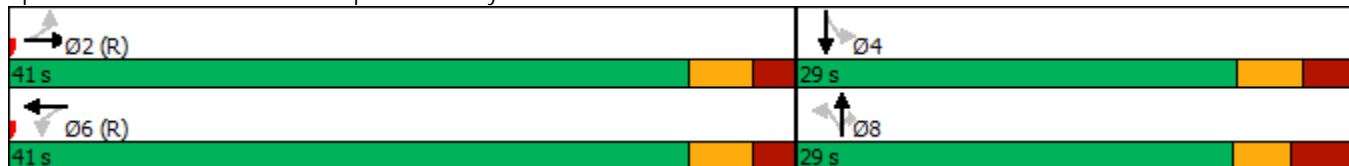

Lanes, Volumes, Timings

9: NC 86 (S. Columbia St)/NC 86 (N. Columbia St) & W. Franklin Street/E. Franklin Street 09/01/2020



Lane Group	EBL	EBT	EBR	WBL	WBT	WBR	NBL	NBT	NBR	SBL	SBT	SBR
Lane Configurations												
Traffic Volume (vph)	180	434	76	102	519	67	65	572	113	74	442	126
Future Volume (vph)	180	434	76	102	519	67	65	572	113	74	442	126
Ideal Flow (vphpl)	1900	1900	1900	1900	1900	1900	1900	1900	1900	1900	1900	1900
Lane Width (ft)	9	12	13	10	10	13	9	10	10	9	9	11
Grade (%)		3%			1%			-2%			3%	
Storage Length (ft)	250		0	125		0	475		0	125		0
Storage Lanes	1		0	1		1	1		0	1		0
Taper Length (ft)	25			25			25			25		
Lane Util. Factor	1.00	0.95	0.95	1.00	1.00	1.00	1.00	0.95	0.95	1.00	0.95	0.95
Ped Bike Factor	0.87	0.96		0.87		0.68	0.91	0.96		0.93	0.95	
Frt		0.978				0.850		0.975			0.967	
Flt Protected	0.950			0.950			0.950			0.950		
Satd. Flow (prot)	1412	2933	0	1479	1557	1465	1380	2692	0	1385	2542	0
Flt Permitted	0.950			0.950			0.950			0.950		
Satd. Flow (perm)	1224	2933	0	1289	1557	997	1253	2692	0	1286	2542	0
Right Turn on Red			No			No			No			No
Satd. Flow (RTOR)												
Link Speed (mph)		20			20			25			25	
Link Distance (ft)		461			941			981			353	
Travel Time (s)		15.7			32.1			26.8			9.6	
Confl. Peds. (#/hr)	193		152	152		193	67		108	108		67
Peak Hour Factor	0.87	0.87	0.87	0.84	0.84	0.84	0.90	0.90	0.90	0.94	0.94	0.94
Heavy Vehicles (%)	2%	2%	2%	2%	2%	2%	7%	7%	7%	4%	4%	4%
Adj. Flow (vph)	207	499	87	121	618	80	72	636	126	79	470	134
Shared Lane Traffic (%)												
Lane Group Flow (vph)	207	586	0	121	618	80	72	762	0	79	604	0
Turn Type	Prot	NA		Prot	NA	pm+ov	Prot	NA		Prot	NA	
Protected Phases	5	2		1	6	7	3	8		7	4	
Permitted Phases						6						
Detector Phase	5	2		1	6	7	3	8		7	4	
Switch Phase												
Minimum Initial (s)	7.0	10.0		7.0	10.0	7.0	7.0	7.0		7.0	7.0	
Minimum Split (s)	15.0	28.2		15.0	28.2	15.0	15.0	28.0		15.0	28.1	
Total Split (s)	22.0	36.0		43.0	57.0	15.0	21.0	46.0		15.0	40.0	
Total Split (%)	15.7%	25.7%		30.7%	40.7%	10.7%	15.0%	32.9%		10.7%	28.6%	
Maximum Green (s)	16.6	29.8		37.1	50.8	9.1	15.1	40.1		9.1	34.3	
Yellow Time (s)	3.0	3.0		3.0	3.0	3.0	3.0	3.3		3.0	3.1	
All-Red Time (s)	2.4	3.2		2.9	3.2	2.9	2.9	2.6		2.9	2.6	
Lost Time Adjust (s)	-0.4	-1.2		-0.9	-1.2	-2.0	-0.9	-0.9		-0.9	-0.7	
Total Lost Time (s)	5.0	5.0		5.0	5.0	3.9	5.0	5.0		5.0	5.0	
Lead/Lag	Lead	Lag		Lead	Lag	Lead	Lead	Lag		Lead	Lag	
Lead-Lag Optimize?	Yes	Yes		Yes	Yes	Yes	Yes	Yes		Yes	Yes	
Vehicle Extension (s)	1.0	3.0		1.0	3.0	1.0	1.0	2.0		1.0	2.0	
Recall Mode	None	C-Max		None	C-Max	None	None	Ped		None	Ped	
Walk Time (s)		7.0			7.0			7.0			7.0	
Flash Dont Walk (s)		15.0			15.0			15.0			15.0	
Pedestrian Calls (#/hr)		0			0			0			0	
Act Effect Green (s)	17.6	53.7		15.9	52.0	63.8	11.7	40.8		9.6	41.2	

Lanes, Volumes, Timings

9: NC 86 (S. Columbia St)/NC 86 (N. Columbia St) & W. Franklin Street/E. Franklin Street 09/01/2020

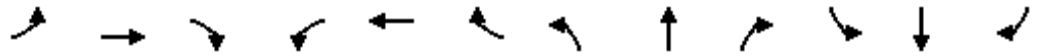

Lane Group	EBL	EBT	EBR	WBL	WBT	WBR	NBL	NBT	NBR	SBL	SBT	SBR
Actuated g/C Ratio	0.13	0.38		0.11	0.37	0.46	0.08	0.29		0.07	0.29	
v/c Ratio	1.17	0.52		0.72	1.07	0.16	0.63	0.97		0.84	0.81	
Control Delay	166.2	36.7		93.2	91.8	21.7	102.0	18.6		124.5	46.9	
Queue Delay	0.0	0.0		0.0	0.0	0.0	0.0	0.0		0.0	1.1	
Total Delay	166.2	36.7		93.2	91.8	21.7	102.0	18.6		124.5	48.0	
LOS	F	D		F	F	C	F	B		F	D	
Approach Delay		70.5			85.1			25.8			56.9	
Approach LOS		E			F			C			E	
Queue Length 50th (ft)	~232	203		113	-639	31	69	108		75	160	
Queue Length 95th (ft)	#374	301		169	#785	m57	m61	m61		m#158	#398	
Internal Link Dist (ft)		381			861			901			273	
Turn Bay Length (ft)	250			125			475			125		
Base Capacity (vph)	177	1125		401	578	494	157	788		98	748	
Starvation Cap Reductn	0	0		0	0	0	0	0		0	37	
Spillback Cap Reductn	0	0		0	0	0	0	0		0	0	
Storage Cap Reductn	0	0		0	0	0	0	0		0	0	
Reduced v/c Ratio	1.17	0.52		0.30	1.07	0.16	0.46	0.97		0.81	0.85	

Intersection Summary

Area Type: CBD
 Cycle Length: 140
 Actuated Cycle Length: 140
 Offset: 0 (0%), Referenced to phase 2:EBT and 6:WBT, Start of Green
 Natural Cycle: 150
 Control Type: Actuated-Coordinated
 Maximum v/c Ratio: 1.17
 Intersection Signal Delay: 59.4 Intersection LOS: E
 Intersection Capacity Utilization 86.5% ICU Level of Service E
 Analysis Period (min) 15
 ~ Volume exceeds capacity, queue is theoretically infinite.
 Queue shown is maximum after two cycles.
 # 95th percentile volume exceeds capacity, queue may be longer.
 Queue shown is maximum after two cycles.
 m Volume for 95th percentile queue is metered by upstream signal.

Splits and Phases: 9: NC 86 (S. Columbia St)/NC 86 (N. Columbia St) & W. Franklin Street/E. Franklin Street



Lanes, Volumes, Timings

10: E. Franklin Street & Henderson Street

09/01/2020



Lane Group	EBL	EBT	WBT	WBR	SBL	SBR
Lane Configurations		↕↕	↕↔		↔↕	
Traffic Volume (vph)	34	607	654	71	168	58
Future Volume (vph)	34	607	654	71	168	58
Ideal Flow (vphpl)	1900	1900	1900	1900	1900	1900
Lane Width (ft)	10	13	10	10	11	11
Grade (%)		-2%	2%		3%	
Lane Util. Factor	0.95	0.95	0.95	0.95	1.00	1.00
Ped Bike Factor		1.00	0.97		0.87	
Frt			0.985		0.965	
Flt Protected		0.997			0.964	
Satd. Flow (prot)	0	3282	2820	0	1398	0
Flt Permitted		0.884			0.964	
Satd. Flow (perm)	0	2898	2820	0	1297	0
Right Turn on Red				No		No
Satd. Flow (RTOR)						
Link Speed (mph)		20	20		20	
Link Distance (ft)		941	1200		366	
Travel Time (s)		32.1	40.9		12.5	
Confl. Peds. (#/hr)	114			114	88	198
Peak Hour Factor	0.90	0.90	0.93	0.93	0.83	0.83
Heavy Vehicles (%)	3%	3%	2%	2%	2%	2%
Parking (#/hr)						0
Adj. Flow (vph)	38	674	703	76	202	70
Shared Lane Traffic (%)						
Lane Group Flow (vph)	0	712	779	0	272	0
Turn Type	Perm	NA	NA		Prot	
Protected Phases		2	6		4	
Permitted Phases	2					
Detector Phase	2	2	6		4	
Switch Phase						
Minimum Initial (s)	10.0	10.0	10.0		7.0	
Minimum Split (s)	16.2	16.2	21.1		24.1	
Total Split (s)	43.0	43.0	43.0		27.0	
Total Split (%)	61.4%	61.4%	61.4%		38.6%	
Maximum Green (s)	36.8	36.8	36.9		21.9	
Yellow Time (s)	3.0	3.0	3.0		3.0	
All-Red Time (s)	3.2	3.2	3.1		2.1	
Lost Time Adjust (s)		-1.2	-1.1		-0.1	
Total Lost Time (s)		5.0	5.0		5.0	
Lead/Lag						
Lead-Lag Optimize?						
Vehicle Extension (s)	2.0	2.0	2.0		1.0	
Recall Mode	C-Max	C-Max	C-Max		None	
Walk Time (s)			7.0		7.0	
Flash Dont Walk (s)			8.0		12.0	
Pedestrian Calls (#/hr)			0		0	
Act Effct Green (s)		43.3	43.3		16.7	
Actuated g/C Ratio		0.62	0.62		0.24	
v/c Ratio		0.40	0.45		0.82	

Lanes, Volumes, Timings
 10: E. Franklin Street & Henderson Street

09/01/2020

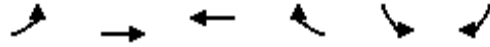

Lane Group	EBL	EBT	WBT	WBR	SBL	SBR
Control Delay		9.4	6.0		42.1	
Queue Delay		0.0	0.0		0.0	
Total Delay		9.4	6.0		42.1	
LOS		A	A		D	
Approach Delay		9.4	6.0		42.1	
Approach LOS		A	A		D	
Queue Length 50th (ft)		194	74		114	
Queue Length 95th (ft)		m164	161		144	
Internal Link Dist (ft)		861	1120		286	
Turn Bay Length (ft)						
Base Capacity (vph)		1793	1745		439	
Starvation Cap Reductn		0	0		0	
Spillback Cap Reductn		0	0		0	
Storage Cap Reductn		0	0		0	
Reduced v/c Ratio		0.40	0.45		0.62	

Intersection Summary

Area Type: CBD
 Cycle Length: 70
 Actuated Cycle Length: 70
 Offset: 27 (39%), Referenced to phase 2:EBTL and 6:WBT, Start of Green
 Natural Cycle: 50
 Control Type: Actuated-Coordinated
 Maximum v/c Ratio: 0.82
 Intersection Signal Delay: 12.9
 Intersection LOS: B
 Intersection Capacity Utilization 71.4%
 ICU Level of Service C
 Analysis Period (min) 15
 m Volume for 95th percentile queue is metered by upstream signal.

Splits and Phases: 10: E. Franklin Street & Henderson Street

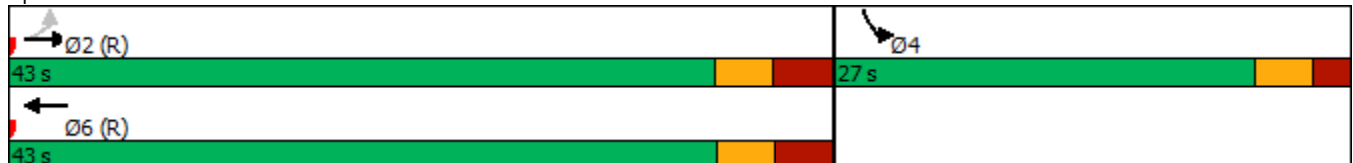

Lanes, Volumes, Timings

11: Raleigh Street/Hillsborough Street & E. Franklin Street

09/01/2020



Lane Group	EBL	EBT	EBR	WBL	WBT	WBR	NBL	NBT	NBR	SBL	SBT	SBR
Lane Configurations												
Traffic Volume (vph)	52	555	239	63	671	244	52	200	23	65	208	13
Future Volume (vph)	52	555	239	63	671	244	52	200	23	65	208	13
Ideal Flow (vphpl)	1900	1900	1900	1900	1900	1900	1900	1900	1900	1900	1900	1900
Lane Width (ft)	9	9	10	9	10	11	12	12	12	10	10	10
Grade (%)		1%			-2%			1%			1%	
Storage Length (ft)	75		0	75		0	0		0	100		0
Storage Lanes	1		0	1		0	0		0	1		0
Taper Length (ft)	25			25			25			25		
Lane Util. Factor	1.00	0.95	0.95	1.00	0.95	0.95	1.00	1.00	1.00	1.00	1.00	1.00
Ped Bike Factor	1.00	0.99		1.00	0.99			0.99		0.99	0.99	
Frt		0.955			0.960			0.989			0.991	
Flt Protected	0.950			0.950				0.991		0.950		
Satd. Flow (prot)	1585	2995	0	1609	3173	0	0	1813	0	1643	1702	0
Flt Permitted	0.244			0.286				0.697		0.406		
Satd. Flow (perm)	406	2995	0	482	3173	0	0	1263	0	698	1702	0
Right Turn on Red			No			No			No			No
Satd. Flow (RTOR)												
Link Speed (mph)		20			30			25			25	
Link Distance (ft)		1200			1013			995			363	
Travel Time (s)		40.9			23.0			27.1			9.9	
Confl. Peds. (#/hr)	16		16	16		16	58		7	7		58
Peak Hour Factor	0.91	0.91	0.91	0.92	0.92	0.92	0.93	0.93	0.93	0.88	0.88	0.88
Adj. Flow (vph)	57	610	263	68	729	265	56	215	25	74	236	15
Shared Lane Traffic (%)												
Lane Group Flow (vph)	57	873	0	68	994	0	0	296	0	74	251	0
Turn Type	Perm	NA		Perm	NA		pm+pt	NA		D.Pm	NA	
Protected Phases		2			6		7	4				8
Permitted Phases	2			6			4			4		
Detector Phase	2	2		6	6		7	4		4		8
Switch Phase												
Minimum Initial (s)	10.0	10.0		10.0	10.0		7.0	7.0		7.0	7.0	
Minimum Split (s)	16.0	16.0		16.0	16.0		14.0	30.0		30.0	29.0	
Total Split (s)	79.0	79.0		79.0	79.0		14.0	61.0		61.0	47.0	
Total Split (%)	56.4%	56.4%		56.4%	56.4%		10.0%	43.6%		43.6%	33.6%	
Maximum Green (s)	73.7	73.7		73.7	73.7		7.8	54.6		54.6	40.6	
Yellow Time (s)	3.0	3.0		3.0	3.0		3.0	3.1		3.1	3.1	
All-Red Time (s)	2.3	2.3		2.3	2.3		3.2	3.3		3.3	3.3	
Lost Time Adjust (s)	-0.3	-0.3		-0.3	-0.3			-1.4		-1.4	-1.4	
Total Lost Time (s)	5.0	5.0		5.0	5.0			5.0		5.0	5.0	
Lead/Lag							Lead					Lag
Lead-Lag Optimize?												
Vehicle Extension (s)	3.0	3.0		3.0	3.0		3.0	2.0		2.0	2.0	
Recall Mode	C-Max	C-Max		C-Max	C-Max		None	None		None	None	
Walk Time (s)								7.0		7.0	7.0	
Flash Dont Walk (s)								16.0		16.0	15.0	
Pedestrian Calls (#/hr)								0		0	0	
Act Effect Green (s)	93.0	93.0		93.0	93.0			37.0		37.0	37.0	
Actuated g/C Ratio	0.66	0.66		0.66	0.66			0.26		0.26	0.26	

Lanes, Volumes, Timings

11: Raleigh Street/Hillsborough Street & E. Franklin Street

09/01/2020



Lane Group	EBL	EBT	EBR	WBL	WBT	WBR	NBL	NBT	NBR	SBL	SBT	SBR
v/c Ratio	0.21	0.44		0.21	0.47			0.89		0.40	0.56	
Control Delay	6.6	5.5		13.5	13.5			76.2		42.4	43.3	
Queue Delay	0.0	0.0		0.0	0.0			0.0		0.0	1.1	
Total Delay	6.6	5.5		13.5	13.5			76.2		42.4	44.4	
LOS	A	A		B	B			E		D	D	
Approach Delay		5.6			13.5			76.2			43.9	
Approach LOS		A			B			E			D	
Queue Length 50th (ft)	8	73		23	218			260		52	179	
Queue Length 95th (ft)	m20	143		60	337			343		84	221	
Internal Link Dist (ft)		1120			933			915			283	
Turn Bay Length (ft)	75			75						100		
Base Capacity (vph)	269	1989		320	2107			505		279	526	
Starvation Cap Reductn	0	0		0	0			0		0	113	
Spillback Cap Reductn	0	0		0	0			0		0	0	
Storage Cap Reductn	0	0		0	0			0		0	0	
Reduced v/c Ratio	0.21	0.44		0.21	0.47			0.59		0.27	0.61	

Intersection Summary





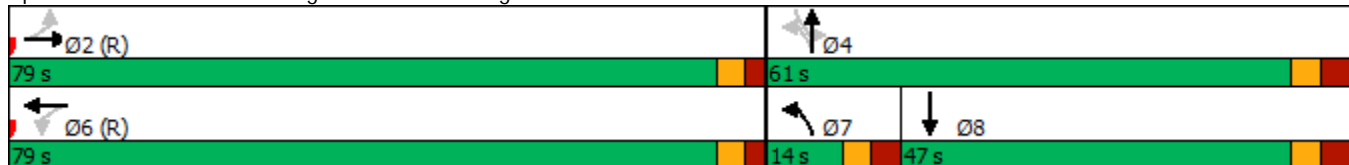













Area Type: Other
 Cycle Length: 140
 Actuated Cycle Length: 140
 Offset: 73 (52%), Referenced to phase 2:EBTL and 6:WBTL, Start of Green
 Natural Cycle: 70
 Control Type: Actuated-Coordinated
 Maximum v/c Ratio: 0.89
 Intersection Signal Delay: 21.6
 Intersection LOS: C
 Intersection Capacity Utilization 84.9%
 ICU Level of Service E
 Analysis Period (min) 15
 m Volume for 95th percentile queue is metered by upstream signal.

Splits and Phases: 11: Raleigh Street/Hillsborough Street & E. Franklin Street



Lanes, Volumes, Timings

13: NC 86 (N. Columbia St)/NC 86 (MLK Jr. Blvd) & North Street & N. Columbia Street 09/01/2020

												
Lane Group	WBL	WBR	WBR2	NBL	NBT	NBR	SBL	SBT	SBR	SEL2	SEL	SER
Lane Configurations												
Traffic Volume (vph)	24	21	148	49	826	23	54	737	6	4	5	101
Future Volume (vph)	24	21	148	49	826	23	54	737	6	4	5	101
Ideal Flow (vphpl)	1900	1900	1900	1900	1900	1900	1900	1900	1900	1900	1900	1900
Grade (%)	2%				-5%			5%				-3%
Storage Length (ft)	0	0		150		0	70		0		0	0
Storage Lanes	1	0		1		0	1		0		1	0
Taper Length (ft)	25			25			25				25	
Lane Util. Factor	1.00	1.00	1.00	1.00	0.95	0.95	1.00	0.95	0.95	1.00	1.00	1.00
Ped Bike Factor				1.00	1.00		0.99	1.00			1.00	
Frt	0.882				0.996			0.999				0.875
Flt Protected	0.994			0.950			0.950				0.996	
Satd. Flow (prot)	1617	0	0	1796	3573	0	1709	3413	0	0	1601	0
Flt Permitted	0.994			0.280			0.216				0.996	
Satd. Flow (perm)	1617	0	0	528	3573	0	386	3413	0	0	1598	0
Right Turn on Red			No			No			No			No
Satd. Flow (RTOR)												
Link Speed (mph)	20				35			35				25
Link Distance (ft)	246				476			2108				715
Travel Time (s)	8.4				9.3			41.1				19.5
Confl. Peds. (#/hr)				7		32	32		7	8		
Peak Hour Factor	0.87	0.87	0.87	0.83	0.83	0.83	0.88	0.88	0.88	0.92	0.92	0.92
Heavy Vehicles (%)	2%	2%	2%	3%	3%	3%	3%	3%	3%	5%	5%	5%
Adj. Flow (vph)	28	24	170	59	995	28	61	838	7	4	5	110
Shared Lane Traffic (%)												
Lane Group Flow (vph)	222	0	0	59	1023	0	61	845	0	0	119	0
Turn Type	Prot			Perm	NA		Perm	NA		Prot	Prot	
Protected Phases	3				2			6		4	4	
Permitted Phases				2			6					
Detector Phase	3			2	2		6	6		4	4	
Switch Phase												
Minimum Initial (s)	7.0			10.0	10.0		10.0	10.0		7.0	7.0	
Minimum Split (s)	14.0			17.0	17.0		17.0	17.0		14.0	14.0	
Total Split (s)	35.0			82.0	82.0		82.0	82.0		23.0	23.0	
Total Split (%)	25.0%			58.6%	58.6%		58.6%	58.6%		16.4%	16.4%	
Maximum Green (s)	28.0			75.0	75.0		75.0	75.0		16.0	16.0	
Yellow Time (s)	5.0			5.0	5.0		5.0	5.0		5.0	5.0	
All-Red Time (s)	2.0			2.0	2.0		2.0	2.0		2.0	2.0	
Lost Time Adjust (s)	-2.0			-2.0	-2.0		-2.0	-2.0			-2.0	
Total Lost Time (s)	5.0			5.0	5.0		5.0	5.0			5.0	
Lead/Lag	Lead									Lag	Lag	
Lead-Lag Optimize?	Yes									Yes	Yes	
Vehicle Extension (s)	3.0			3.0	3.0		3.0	3.0		3.0	3.0	
Recall Mode	None			C-Max	C-Max		C-Max	C-Max		None	None	
Act Effect Green (s)	25.4			83.4	83.4		83.4	83.4			16.1	
Actuated g/C Ratio	0.18			0.60	0.60		0.60	0.60			0.12	
v/c Ratio	0.76			0.19	0.48		0.27	0.42			0.65	
Control Delay	70.5			13.6	13.9		19.6	16.9			75.4	
Queue Delay	0.0			0.0	0.4		0.0	0.0			0.0	

Lanes, Volumes, Timings

13: NC 86 (N. Columbia St)/NC 86 (MLK Jr. Blvd) & North Street & N. Columbia Street 09/01/2020



Lane Group	WBL	WBR	WBR2	NBL	NBT	NBR	SBL	SBT	SBR	SEL2	SEL	SER
Total Delay	70.5			13.6	14.3		19.6	16.9				75.4
LOS	E			B	B		B	B				E
Approach Delay	70.5				14.3			17.1				75.4
Approach LOS	E				B			B				E
Queue Length 50th (ft)	192			16	146		27	217				104
Queue Length 95th (ft)	267			m22	m163		62	277				173
Internal Link Dist (ft)	166				396			2028				635
Turn Bay Length (ft)				150			70					
Base Capacity (vph)	346			314	2129		230	2033				206
Starvation Cap Reductn	0			0	571		0	0				0
Spillback Cap Reductn	0			0	0		0	0				0
Storage Cap Reductn	0			0	0		0	0				0
Reduced v/c Ratio	0.64			0.19	0.66		0.27	0.42				0.58

Intersection Summary

Area Type:	Other
Cycle Length:	140
Actuated Cycle Length:	140
Offset:	62 (44%), Referenced to phase 2:NBTL and 6:SBTL, Start of Green
Natural Cycle:	60
Control Type:	Actuated-Coordinated
Maximum v/c Ratio:	0.76
Intersection Signal Delay:	23.8
Intersection LOS:	C
Intersection Capacity Utilization	67.2%
ICU Level of Service	C
Analysis Period (min)	15
m	Volume for 95th percentile queue is metered by upstream signal.

Splits and Phases: 13: NC 86 (N. Columbia St)/NC 86 (MLK Jr. Blvd) & North Street & N. Columbia Street

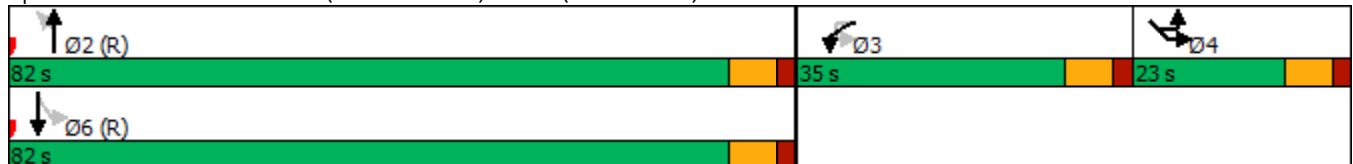

Lanes, Volumes, Timings

14: NC 86 (MLK Jr. Blvd) & Longview Street/Mill Creek Apts Driveway

09/01/2020



Lane Group	EBL	EBT	EBR	WBL	WBT	WBR	NBL	NBT	NBR	SBL	SBT	SBR
Lane Configurations		↕			↕		↕	↕↔		↕	↕↔	
Traffic Volume (vph)	97	2	18	34	1	8	14	955	13	11	672	78
Future Volume (vph)	97	2	18	34	1	8	14	955	13	11	672	78
Ideal Flow (vphpl)	1900	1900	1900	1900	1900	1900	1900	1900	1900	1900	1900	1900
Grade (%)		-6%			1%			2%			-4%	
Storage Length (ft)	0		0	0		0	225		0	250		0
Storage Lanes	0		0	0		0	1		0	1		0
Taper Length (ft)	25			25			25			25		
Lane Util. Factor	1.00	1.00	1.00	1.00	1.00	1.00	1.00	0.95	0.95	1.00	0.95	0.95
Ped Bike Factor		0.99			0.99		0.99	1.00		0.99	1.00	
Frt		0.979			0.974			0.998			0.984	
Flt Protected		0.960			0.962		0.950			0.950		
Satd. Flow (prot)	0	1795	0	0	1732	0	1735	3459	0	1787	3504	0
Flt Permitted		0.722			0.754		0.336			0.214		
Satd. Flow (perm)	0	1348	0	0	1341	0	610	3459	0	398	3504	0
Right Turn on Red			No			No			No			No
Satd. Flow (RTOR)												
Link Speed (mph)		25			20			35			35	
Link Distance (ft)		451			338			2108			784	
Travel Time (s)		12.3			11.5			41.1			15.3	
Confl. Peds. (#/hr)	2		20	20		2	7		28	28		7
Peak Hour Factor	0.89	0.89	0.89	0.75	0.75	0.75	0.86	0.86	0.86	0.93	0.93	0.93
Heavy Vehicles (%)	2%	2%	2%	2%	2%	2%	3%	3%	3%	3%	3%	3%
Adj. Flow (vph)	109	2	20	45	1	11	16	1110	15	12	723	84
Shared Lane Traffic (%)												
Lane Group Flow (vph)	0	131	0	0	57	0	16	1125	0	12	807	0
Turn Type	Perm	NA		Perm	NA		Perm	NA		Perm	NA	
Protected Phases		4			8			2			6	
Permitted Phases	4			8			2			6		
Detector Phase	4	4		8	8		2	2		6	6	
Switch Phase												
Minimum Initial (s)	7.0	7.0		7.0	7.0		12.0	12.0		12.0	12.0	
Minimum Split (s)	31.0	31.0		14.0	14.0		28.0	28.0		28.0	28.0	
Total Split (s)	20.0	20.0		20.0	20.0		60.0	60.0		60.0	60.0	
Total Split (%)	25.0%	25.0%		25.0%	25.0%		75.0%	75.0%		75.0%	75.0%	
Maximum Green (s)	14.0	14.0		13.9	13.9		54.0	54.0		54.5	54.5	
Yellow Time (s)	3.5	3.5		3.0	3.0		4.5	4.5		4.0	4.0	
All-Red Time (s)	2.5	2.5		3.1	3.1		1.5	1.5		1.5	1.5	
Lost Time Adjust (s)		-1.0			-1.0		-1.0	-1.0		-0.5	-0.5	
Total Lost Time (s)		5.0			5.1		5.0	5.0		5.0	5.0	
Lead/Lag												
Lead-Lag Optimize?												
Vehicle Extension (s)	3.0	3.0		3.0	3.0		3.0	3.0		3.0	3.0	
Recall Mode	None	None		None	None		Min	Min		Min	Min	
Walk Time (s)	7.0	7.0					7.0	7.0		7.0	7.0	
Flash Dont Walk (s)	17.0	17.0					9.0	9.0		9.0	9.0	
Pedestrian Calls (#/hr)	0	0					0	0		0	0	
Act Effct Green (s)		11.0			10.9		29.4	29.4		29.4	29.4	
Actuated g/C Ratio		0.24			0.24		0.64	0.64		0.64	0.64	

Lanes, Volumes, Timings

14: NC 86 (MLK Jr. Blvd) & Longview Street/Mill Creek Apts Driveway

09/01/2020



Lane Group	EBL	EBT	EBR	WBL	WBT	WBR	NBL	NBT	NBR	SBL	SBT	SBR
v/c Ratio		0.41			0.18		0.04	0.51		0.05	0.36	
Control Delay		21.1			17.7		5.6	7.5		5.9	6.3	
Queue Delay		0.0			0.0		0.0	0.0		0.0	0.0	
Total Delay		21.1			17.7		5.6	7.5		5.9	6.3	
LOS		C			B		A	A		A	A	
Approach Delay		21.1			17.7			7.5			6.3	
Approach LOS		C			B			A			A	
Queue Length 50th (ft)		29			12		2	89		1	55	
Queue Length 95th (ft)		82			34		9	151		8	104	
Internal Link Dist (ft)		371			258			2028			704	
Turn Bay Length (ft)							225			250		
Base Capacity (vph)		460			455		600	3400		391	3444	
Starvation Cap Reductn		0			0		0	0		0	0	
Spillback Cap Reductn		0			0		0	0		0	0	
Storage Cap Reductn		0			0		0	0		0	0	
Reduced v/c Ratio		0.28			0.13		0.03	0.33		0.03	0.23	

Intersection Summary

Area Type:	Other
Cycle Length:	80
Actuated Cycle Length:	45.8
Natural Cycle:	60
Control Type:	Actuated-Uncoordinated
Maximum v/c Ratio:	0.51
Intersection Signal Delay:	8.1
Intersection LOS:	A
Intersection Capacity Utilization:	48.8%
ICU Level of Service:	A
Analysis Period (min):	15

Splits and Phases: 14: NC 86 (MLK Jr. Blvd) & Longview Street/Mill Creek Apts Driveway



Lanes, Volumes, Timings
 15: NC 86 (Pittsboro St) & W. Cameron Avenue

09/01/2020

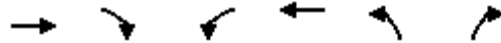

Lane Group	EBT	EBR	WBL	WBT	NBL	NBR	Ø1	Ø4
Lane Configurations	↻		↻↻	↻				
Traffic Volume (vph)	149	222	568	365	0	0		
Future Volume (vph)	149	222	568	365	0	0		
Ideal Flow (vphpl)	1900	1900	1900	1900	1900	1900		
Lane Width (ft)	12	12	11	12	12	12		
Grade (%)	3%			-3%	0%			
Storage Length (ft)		0	75		0	0		
Storage Lanes		0	0		0	0		
Taper Length (ft)			25		25			
Lane Util. Factor	1.00	1.00	0.97	1.00	1.00	1.00		
Ped Bike Factor	0.84		0.74					
Frt	0.919							
Flt Protected			0.950					
Satd. Flow (prot)	1269	0	2890	1622	0	0		
Flt Permitted			0.950					
Satd. Flow (perm)	1269	0	2150	1622	0	0		
Right Turn on Red		No				No		
Satd. Flow (RTOR)								
Link Speed (mph)	25			25	25			
Link Distance (ft)	391			120	794			
Travel Time (s)	30.0			10.7	21.7			
Confl. Peds. (#/hr)		70	70					
Peak Hour Factor	0.93	0.93	0.96	0.96	0.90	0.90		
Heavy Vehicles (%)	2%	2%	7%	7%	2%	2%		
Adj. Flow (vph)	160	239	592	380	0	0		
Shared Lane Traffic (%)								
Lane Group Flow (vph)	399	0	592	380	0	0		
Turn Type	NA		Prot	NA				
Protected Phases	2		1 4	6			1	4
Permitted Phases								
Detector Phase	2		1 4	6				
Switch Phase								
Minimum Initial (s)	10.0			10.0			7.0	7.0
Minimum Split (s)	20.1			20.0			20.0	21.0
Total Split (s)	44.0			102.0			58.0	38.0
Total Split (%)	31.4%			72.9%			41%	27%
Maximum Green (s)	38.9			97.0			52.9	34.0
Yellow Time (s)	3.0			3.3			3.0	3.0
All-Red Time (s)	2.1			1.7			2.1	1.0
Lost Time Adjust (s)	-0.1			0.0				
Total Lost Time (s)	5.0			5.0				
Lead/Lag	Lead						Lag	
Lead-Lag Optimize?								
Vehicle Extension (s)	1.0			1.0			4.0	0.2
Recall Mode	None			C-Max			C-Max	None
Walk Time (s)	7.0							7.0
Flash Dont Walk (s)	4.0							9.0
Pedestrian Calls (#/hr)	0							0
Act Effect Green (s)	57.6		72.4	124.0				

Lanes, Volumes, Timings
 15: NC 86 (Pittsboro St) & W. Cameron Avenue

09/01/2020



Lane Group	EBT	EBR	WBL	WBT	NBL	NBR	Ø1	Ø4
Actuated g/C Ratio	0.41		0.52	0.89				
v/c Ratio	0.77		0.40	0.26				
Control Delay	47.5		13.3	1.0				
Queue Delay	0.0		0.1	0.8				
Total Delay	47.5		13.4	1.8				
LOS	D		B	A				
Approach Delay	47.5			8.9				
Approach LOS	D			A				
Queue Length 50th (ft)	325		89	6				
Queue Length 95th (ft)	447		m121	m47				
Internal Link Dist (ft)	311			40	714			
Turn Bay Length (ft)			75					
Base Capacity (vph)	521		2052	1436				
Starvation Cap Reductn	0		505	741				
Spillback Cap Reductn	0		0	0				
Storage Cap Reductn	0		0	0				
Reduced v/c Ratio	0.77		0.38	0.55				

Intersection Summary

Area Type: CBD
 Cycle Length: 140
 Actuated Cycle Length: 140
 Offset: 104 (74%), Referenced to phase 1:WBL and 6:WBT, Start of Green
 Natural Cycle: 70
 Control Type: Actuated-Coordinated
 Maximum v/c Ratio: 0.77
 Intersection Signal Delay: 20.1
 Intersection LOS: C
 Intersection Capacity Utilization 53.1%
 ICU Level of Service A
 Analysis Period (min) 15
 m Volume for 95th percentile queue is metered by upstream signal.

Splits and Phases: 15: NC 86 (Pittsboro St) & W. Cameron Avenue

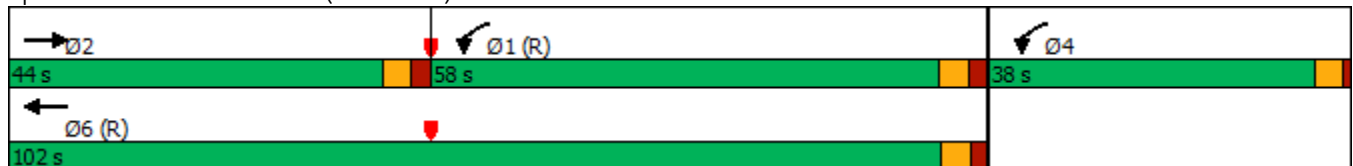

Lanes, Volumes, Timings

16: NC 86 (S. Columbia St) & W. Cameron Avenue/E. Cameron Avenue

09/01/2020



Lane Group	EBL	EBT	EBR	WBL	WBT	WBR	NBL	NBT	NBR	SBL	SBT	SBR
Lane Configurations												
Traffic Volume (vph)	20	123	0	0	168	52	222	675	60	120	0	530
Future Volume (vph)	20	123	0	0	168	52	222	675	60	120	0	530
Ideal Flow (vphpl)	1900	1900	1900	1900	1900	1900	1900	1900	1900	1900	1900	1900
Lane Width (ft)	11	12	12	12	12	12	10	10	10	11	11	12
Grade (%)		1%			-1%			1%			2%	
Storage Length (ft)	100		0	0		0	0		0	310		0
Storage Lanes	1		0	0		0	1		0	1		2
Taper Length (ft)	25			25			25			25		
Lane Util. Factor	1.00	1.00	1.00	1.00	1.00	1.00	0.91	0.91	0.95	1.00	1.00	0.88
Ped Bike Factor	0.86				0.93		0.68	0.94		0.79		0.60
Frt					0.968			0.988				0.850
Flt Protected	0.950						0.950	0.999		0.950		
Satd. Flow (prot)	1532	1668	0	0	1493	0	1295	2543	0	1453	0	2367
Flt Permitted	0.290						0.950	0.999		0.950		
Satd. Flow (perm)	401	1668	0	0	1493	0	884	2519	0	1154	0	1418
Right Turn on Red			No			No			No			No
Satd. Flow (RTOR)												
Link Speed (mph)		25			25			25				25
Link Distance (ft)		273			989			826				981
Travel Time (s)		10.7			57.6			22.5				26.8
Confl. Peds. (#/hr)	157		172	172		157	111		248	248		111
Peak Hour Factor	0.91	0.91	0.91	0.90	0.90	0.90	0.87	0.87	0.87	0.85	0.85	0.85
Heavy Vehicles (%)	2%	2%	2%	4%	4%	4%	6%	6%	6%	7%	7%	7%
Adj. Flow (vph)	22	135	0	0	187	58	255	776	69	141	0	624
Shared Lane Traffic (%)							10%					
Lane Group Flow (vph)	22	135	0	0	245	0	229	871	0	141	0	624
Turn Type	Perm	NA			NA		Split	NA		Prot		Prot
Protected Phases		4			8		2	2		1		1
Permitted Phases	4									1		1
Detector Phase	4	4			8		2	2		1		1
Switch Phase												
Minimum Initial (s)	10.0	10.0			10.0		7.0	7.0		7.0		7.0
Minimum Split (s)	24.0	24.0			31.0		18.0	18.0		26.0		26.0
Total Split (s)	31.0	31.0			31.0		47.0	47.0		34.0		34.0
Total Split (%)	22.1%	22.1%			22.1%		33.6%	33.6%		24.3%		24.3%
Maximum Green (s)	24.8	24.8			24.8		41.1	41.1		28.4		28.4
Yellow Time (s)	3.2	3.2			3.2		3.1	3.1		3.0		3.0
All-Red Time (s)	3.0	3.0			3.0		2.8	2.8		2.6		2.6
Lost Time Adjust (s)	-1.2	-1.2			-1.2		-0.9	-0.9		-0.6		-0.6
Total Lost Time (s)	5.0	5.0			5.0		5.0	5.0		5.0		5.0
Lead/Lag							Lag	Lag		Lead		Lead
Lead-Lag Optimize?												
Vehicle Extension (s)	2.0	2.0			2.0		4.0	4.0		4.0		4.0
Recall Mode	None	None			None		C-Max	C-Max		None		None
Walk Time (s)	7.0	7.0			7.0		7.0	7.0		7.0		7.0
Flash Dont Walk (s)	10.0	10.0			17.0		5.0	5.0		13.0		13.0
Pedestrian Calls (#/hr)	0	0			0		0	0		0		0
Act Effct Green (s)	25.1	25.1			25.1		44.0	44.0		55.9		55.9

Lanes, Volumes, Timings

16: NC 86 (S. Columbia St) & W. Cameron Avenue/E. Cameron Avenue

09/01/2020

Lane Group	Ø9
Lane Configurations	
Traffic Volume (vph)	
Future Volume (vph)	
Ideal Flow (vphpl)	
Lane Width (ft)	
Grade (%)	
Storage Length (ft)	
Storage Lanes	
Taper Length (ft)	
Lane Util. Factor	
Ped Bike Factor	
Frt	
Flt Protected	
Satd. Flow (prot)	
Flt Permitted	
Satd. Flow (perm)	
Right Turn on Red	
Satd. Flow (RTOR)	
Link Speed (mph)	
Link Distance (ft)	
Travel Time (s)	
Confl. Peds. (#/hr)	
Peak Hour Factor	
Heavy Vehicles (%)	
Adj. Flow (vph)	
Shared Lane Traffic (%)	
Lane Group Flow (vph)	
Turn Type	
Protected Phases	9
Permitted Phases	
Detector Phase	
Switch Phase	
Minimum Initial (s)	7.0
Minimum Split (s)	28.0
Total Split (s)	28.0
Total Split (%)	20%
Maximum Green (s)	24.0
Yellow Time (s)	3.0
All-Red Time (s)	1.0
Lost Time Adjust (s)	
Total Lost Time (s)	
Lead/Lag	
Lead-Lag Optimize?	
Vehicle Extension (s)	0.2
Recall Mode	None
Walk Time (s)	7.0
Flash Dont Walk (s)	17.0
Pedestrian Calls (#/hr)	0
Act Effect Green (s)	

Lanes, Volumes, Timings

16: NC 86 (S. Columbia St) & W. Cameron Avenue/E. Cameron Avenue

09/01/2020

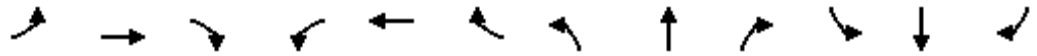

Lane Group	EBL	EBT	EBR	WBL	WBT	WBR	NBL	NBT	NBR	SBL	SBT	SBR
Actuated g/C Ratio	0.18	0.18			0.18		0.31	0.31		0.40		0.40
v/c Ratio	0.31	0.45			0.92		0.56	1.09		0.24		0.66
Control Delay	24.8	21.1			93.4		46.0	103.8		16.0		25.5
Queue Delay	0.0	0.0			0.0		0.0	0.0		0.0		0.0
Total Delay	24.8	21.1			93.4		46.0	103.8		16.0		25.5
LOS	C	C			F		D	F		B		C
Approach Delay		21.6			93.4			91.7			23.8	
Approach LOS		C			F			F			C	
Queue Length 50th (ft)	11	74			220		189	~481		79		266
Queue Length 95th (ft)	m16	m104			#377		278	#593		m97		342
Internal Link Dist (ft)		193			909			746				901
Turn Bay Length (ft)	100									310		
Base Capacity (vph)	74	309			277		407	799		579		944
Starvation Cap Reductn	0	0			0		0	0		0		0
Spillback Cap Reductn	0	0			0		0	0		0		0
Storage Cap Reductn	0	0			0		0	0		0		0
Reduced v/c Ratio	0.30	0.44			0.88		0.56	1.09		0.24		0.66

Intersection Summary

Area Type: CBD
 Cycle Length: 140
 Actuated Cycle Length: 140
 Offset: 23 (16%), Referenced to phase 2:NBTL, Start of Green
 Natural Cycle: 145
 Control Type: Actuated-Coordinated
 Maximum v/c Ratio: 1.09
 Intersection Signal Delay: 64.1 Intersection LOS: E
 Intersection Capacity Utilization 80.9% ICU Level of Service D
 Analysis Period (min) 15
 ~ Volume exceeds capacity, queue is theoretically infinite.
 Queue shown is maximum after two cycles.
 # 95th percentile volume exceeds capacity, queue may be longer.
 Queue shown is maximum after two cycles.
 m Volume for 95th percentile queue is metered by upstream signal.

Splits and Phases: 16: NC 86 (S. Columbia St) & W. Cameron Avenue/E. Cameron Avenue

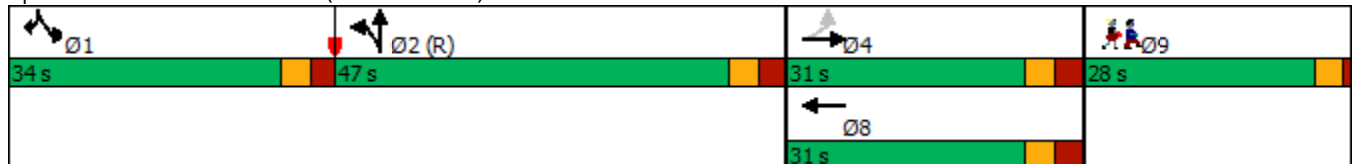

Lanes, Volumes, Timings

16: NC 86 (S. Columbia St) & W. Cameron Avenue/E. Cameron Avenue

09/01/2020

Lane Group	Ø9
Actuated g/C Ratio	
v/c Ratio	
Control Delay	
Queue Delay	
Total Delay	
LOS	
Approach Delay	
Approach LOS	
Queue Length 50th (ft)	
Queue Length 95th (ft)	
Internal Link Dist (ft)	
Turn Bay Length (ft)	
Base Capacity (vph)	
Starvation Cap Reductn	
Spillback Cap Reductn	
Storage Cap Reductn	
Reduced v/c Ratio	
Intersection Summary	

Lanes, Volumes, Timings

17: Raleigh Street & E. Cameron Avenue/Country Club Road

09/01/2020



Lane Group	EBL	EBT	EBR	WBL	WBT	WBR	NBL	NBT	NBR	SBL	SBT	SBR
Lane Configurations		↕		↖	↗		↖	↗		↖	↗	
Traffic Volume (vph)	27	164	47	35	130	183	56	93	62	275	188	54
Future Volume (vph)	27	164	47	35	130	183	56	93	62	275	188	54
Ideal Flow (vphpl)	1900	1900	1900	1900	1900	1900	1900	1900	1900	1900	1900	1900
Grade (%)		-3%			3%			-2%				1%
Storage Length (ft)	0		0	150		0	125		0	75		0
Storage Lanes	0		0	1		0	1		0	1		0
Taper Length (ft)	25			25			25			25		
Lane Util. Factor	1.00	1.00	1.00	1.00	1.00	1.00	1.00	1.00	1.00	1.00	1.00	1.00
Ped Bike Factor		0.94			0.88			0.88		0.82	0.88	
Frt		0.973			0.912			0.940			0.967	
Flt Protected		0.994		0.950			0.950			0.950		
Satd. Flow (prot)	0	1572	0	1569	1326	0	1563	1358	0	1585	1418	0
Flt Permitted		0.924		0.371			0.583			0.447		
Satd. Flow (perm)	0	1442	0	613	1326	0	959	1358	0	610	1418	0
Right Turn on Red			No			No			No			No
Satd. Flow (RTOR)												
Link Speed (mph)		25			25			25				25
Link Distance (ft)		598			651			409				995
Travel Time (s)		16.3			17.8			11.2				27.1
Confl. Peds. (#/hr)	39		37	37		39	107		60	60		107
Peak Hour Factor	0.75	0.75	0.75	0.89	0.89	0.89	0.89	0.89	0.89	0.84	0.84	0.84
Heavy Vehicles (%)	2%	2%	2%	2%	2%	2%	5%	5%	5%	2%	2%	2%
Adj. Flow (vph)	36	219	63	39	146	206	63	104	70	327	224	64
Shared Lane Traffic (%)												
Lane Group Flow (vph)	0	318	0	39	352	0	63	174	0	327	288	0
Turn Type	Perm	NA		pm+pt	NA		pm+pt	NA		pm+pt	NA	
Protected Phases		2		1	6		3	8		7	4	
Permitted Phases	2			6			8			4		
Detector Phase	2	2		1	6		3	8		7	4	
Switch Phase												
Minimum Initial (s)	10.0	10.0		7.0	10.0		7.0	7.0		7.0	7.0	
Minimum Split (s)	18.0	18.0		13.0	19.0		13.0	19.0		12.0	16.0	
Total Split (s)	50.0	50.0		20.0	70.0		20.0	35.0		20.0	35.0	
Total Split (%)	40.0%	40.0%		16.0%	56.0%		16.0%	28.0%		16.0%	28.0%	
Maximum Green (s)	43.9	43.9		14.4	64.4		14.7	29.7		15.1	29.9	
Yellow Time (s)	3.3	3.3		3.0	3.1		3.0	3.1		3.0	3.1	
All-Red Time (s)	2.8	2.8		2.6	2.5		2.3	2.2		1.9	2.0	
Lost Time Adjust (s)		-1.1		-0.6	-0.6		-0.3	-0.3		0.1	-0.1	
Total Lost Time (s)		5.0		5.0	5.0		5.0	5.0		5.0	5.0	
Lead/Lag	Lag	Lag		Lead			Lead	Lag		Lead	Lag	
Lead-Lag Optimize?	Yes	Yes		Yes			Yes	Yes		Yes	Yes	
Vehicle Extension (s)	2.0	2.0		2.0	2.0		2.0	2.0		2.0	2.0	
Recall Mode	None	None		None	None		None	None		None	None	
Walk Time (s)	4.0	4.0			4.0			4.0			4.0	
Flash Dont Walk (s)	7.0	7.0			9.0			9.0			6.0	
Pedestrian Calls (#/hr)	0	0			0			0			0	
Act Effect Green (s)		24.8		31.3	31.3		24.3	16.0		37.3	27.4	
Actuated g/C Ratio		0.31		0.39	0.39		0.31	0.20		0.47	0.35	

Lanes, Volumes, Timings

17: Raleigh Street & E. Cameron Avenue/Country Club Road

09/01/2020



Lane Group	EBL	EBT	EBR	WBL	WBT	WBR	NBL	NBT	NBR	SBL	SBT	SBR
v/c Ratio		0.71		0.11	0.67		0.18	0.64		0.68	0.59	
Control Delay		35.5		15.3	26.5		17.7	43.3		26.8	33.0	
Queue Delay		0.0		0.0	0.0		0.0	0.0		0.0	0.0	
Total Delay		35.5		15.3	26.5		17.7	43.3		26.8	33.0	
LOS		D		B	C		B	D		C	C	
Approach Delay		35.5			25.4			36.5			29.7	
Approach LOS		D			C			D			C	
Queue Length 50th (ft)		149		11	134		19	85		119	135	
Queue Length 95th (ft)		216		32	256		52	175		#243	253	
Internal Link Dist (ft)		518			571			329			915	
Turn Bay Length (ft)				150			125			75		
Base Capacity (vph)		883		441	1080		512	555		485	583	
Starvation Cap Reductn		0		0	0		0	0		0	0	
Spillback Cap Reductn		0		0	0		0	0		0	0	
Storage Cap Reductn		0		0	0		0	0		0	0	
Reduced v/c Ratio		0.36		0.09	0.33		0.12	0.31		0.67	0.49	

Intersection Summary

Area Type: CBD
 Cycle Length: 125
 Actuated Cycle Length: 79.4
 Natural Cycle: 70
 Control Type: Actuated-Uncoordinated
 Maximum v/c Ratio: 0.71
 Intersection Signal Delay: 30.8
 Intersection LOS: C
 Intersection Capacity Utilization 80.2%
 ICU Level of Service D
 Analysis Period (min) 15
 # 95th percentile volume exceeds capacity, queue may be longer.
 Queue shown is maximum after two cycles.

Splits and Phases: 17: Raleigh Street & E. Cameron Avenue/Country Club Road





2023 With Office Building Site – 1 Site Access Driveway

Lanes, Volumes, Timings
1: Church Street & W. Rosemary Street

09/01/2020



Lane Group	EBL	EBT	EBR	WBL	WBT	WBR	NBL	NBT	NBR	SBL	SBT	SBR
Lane Configurations		↕			↕			↕			↕	
Traffic Volume (vph)	14	304	21	33	306	15	33	24	46	27	39	11
Future Volume (vph)	14	304	21	33	306	15	33	24	46	27	39	11
Ideal Flow (vphpl)	1900	1900	1900	1900	1900	1900	1900	1900	1900	1900	1900	1900
Lane Width (ft)	12	14	12	12	14	12	12	12	12	12	12	12
Grade (%)		1%			-1%			0%			0%	
Lane Util. Factor	1.00	1.00	1.00	1.00	1.00	1.00	1.00	1.00	1.00	1.00	1.00	1.00
Ped Bike Factor		0.99			0.99			0.95			0.97	
Frt		0.992			0.994			0.940			0.981	
Flt Protected		0.998			0.995			0.984			0.983	
Satd. Flow (prot)	0	1736	0	0	1737	0	0	1492	0	0	1602	0
Flt Permitted		0.982			0.947			0.888			0.867	
Satd. Flow (perm)	0	1707	0	0	1650	0	0	1330	0	0	1386	0
Right Turn on Red			No			No			No			No
Satd. Flow (RTOR)												
Link Speed (mph)		20			20			25			25	
Link Distance (ft)		964			757			379			430	
Travel Time (s)		32.9			25.8			10.3			11.7	
Confl. Peds. (#/hr)	20		17	17		20	21		31	31		21
Peak Hour Factor	0.86	0.86	0.86	0.89	0.89	0.89	0.84	0.84	0.84	0.72	0.72	0.72
Heavy Vehicles (%)	3%	3%	3%	4%	4%	4%	2%	2%	2%	2%	2%	2%
Adj. Flow (vph)	16	353	24	37	344	17	39	29	55	38	54	15
Shared Lane Traffic (%)												
Lane Group Flow (vph)	0	393	0	0	398	0	0	123	0	0	107	0
Turn Type	Perm	NA		Perm	NA		Perm	NA		Perm	NA	
Protected Phases		2			6			8			4	
Permitted Phases	2			6			8			4		
Detector Phase	2	2		6	6		8	8		4	4	
Switch Phase												
Minimum Initial (s)	10.0	10.0		10.0	10.0		7.0	7.0		7.0	7.0	
Minimum Split (s)	19.0	19.0		20.0	20.0		19.0	19.0		19.0	19.0	
Total Split (s)	38.0	38.0		38.0	38.0		22.0	22.0		22.0	22.0	
Total Split (%)	63.3%	63.3%		63.3%	63.3%		36.7%	36.7%		36.7%	36.7%	
Maximum Green (s)	33.5	33.5		33.4	33.4		17.1	17.1		17.1	17.1	
Yellow Time (s)	3.1	3.1		3.1	3.1		3.2	3.2		3.2	3.2	
All-Red Time (s)	1.4	1.4		1.5	1.5		1.7	1.7		1.7	1.7	
Lost Time Adjust (s)		0.5			0.4			0.1			0.1	
Total Lost Time (s)		5.0			5.0			5.0			5.0	
Lead/Lag												
Lead-Lag Optimize?												
Vehicle Extension (s)	3.0	3.0		3.0	3.0		3.0	3.0		3.0	3.0	
Recall Mode	C-Max	C-Max		C-Max	C-Max		None	None		None	None	
Walk Time (s)	4.0	4.0		4.0	4.0		4.0	4.0		4.0	4.0	
Flash Dont Walk (s)	5.0	5.0		6.0	6.0		10.0	10.0		10.0	10.0	
Pedestrian Calls (#/hr)	0	0		0	0		0	0		0	0	
Act Effct Green (s)		42.5			42.5			10.9			10.9	
Actuated g/C Ratio		0.71			0.71			0.18			0.18	
v/c Ratio		0.33			0.34			0.51			0.43	
Control Delay		6.1			3.7			25.2			26.1	

Lanes, Volumes, Timings
 1: Church Street & W. Rosemary Street

09/01/2020



Lane Group	EBL	EBT	EBR	WBL	WBT	WBR	NBL	NBT	NBR	SBL	SBT	SBR
Queue Delay		0.0			0.0			0.0			0.0	
Total Delay		6.1			3.7			25.2			26.1	
LOS		A			A			C			C	
Approach Delay		6.1			3.7			25.2			26.1	
Approach LOS		A			A			C			C	
Queue Length 50th (ft)		52			17			41			35	
Queue Length 95th (ft)		111			74			52			53	
Internal Link Dist (ft)		884			677			299			350	
Turn Bay Length (ft)												
Base Capacity (vph)		1209			1168			376			392	
Starvation Cap Reductn		0			0			0			0	
Spillback Cap Reductn		0			0			0			0	
Storage Cap Reductn		0			0			0			0	
Reduced v/c Ratio		0.33			0.34			0.33			0.27	

Intersection Summary

Area Type:	CBD
Cycle Length:	60
Actuated Cycle Length:	60
Offset:	7 (12%), Referenced to phase 2:EBTL and 6:WBTL, Start of Green
Natural Cycle:	40
Control Type:	Actuated-Coordinated
Maximum v/c Ratio:	0.51
Intersection Signal Delay:	9.6
Intersection LOS:	A
Intersection Capacity Utilization:	52.7%
ICU Level of Service:	A
Analysis Period (min):	15

Splits and Phases: 1: Church Street & W. Rosemary Street



Lanes, Volumes, Timings

2: NC 86 (N. Columbia St) & W. Rosemary Street/E. Rosemary Street

09/01/2020



Lane Group	EBL	EBT	EBR	WBL	WBT	WBR	NBL	NBT	NBR	SBL	SBT	SBR
Lane Configurations												
Traffic Volume (vph)	152	230	21	20	171	31	22	312	111	72	565	178
Future Volume (vph)	152	230	21	20	171	31	22	312	111	72	565	178
Ideal Flow (vphpl)	1900	1900	1900	1900	1900	1900	1900	1900	1900	1900	1900	1900
Lane Width (ft)	9	12	13	12	12	12	9	10	12	12	9	11
Grade (%)		1%			1%			-2%			8%	
Storage Length (ft)	100		0	150		0	75		0	150		400
Storage Lanes	1		0	1		0	1		0	1		1
Taper Length (ft)	25			25			25			25		
Lane Util. Factor	1.00	1.00	1.00	1.00	1.00	1.00	1.00	0.95	0.95	1.00	0.95	1.00
Ped Bike Factor	0.99	1.00		0.98	1.00		0.98	0.96		0.95		0.91
Frt		0.988			0.977			0.961				0.850
Flt Protected	0.950			0.950			0.950			0.950		
Satd. Flow (prot)	1426	1643	0	1585	1623	0	1355	2603	0	1485	2673	1285
Flt Permitted	0.281			0.582			0.349			0.431		
Satd. Flow (perm)	418	1643	0	956	1623	0	489	2603	0	640	2673	1169
Right Turn on Red			No			No			No			No
Satd. Flow (RTOR)												
Link Speed (mph)		20			20			25			25	
Link Distance (ft)		757			461			353			476	
Travel Time (s)		25.8			15.7			9.6			13.0	
Confl. Peds. (#/hr)	12		16	16		12	19		34	34		19
Peak Hour Factor	0.86	0.86	0.86	0.90	0.90	0.90	0.90	0.90	0.90	0.88	0.88	0.88
Heavy Vehicles (%)	2%	2%	2%	2%	2%	2%	9%	9%	9%	5%	5%	5%
Adj. Flow (vph)	177	267	24	22	190	34	24	347	123	82	642	202
Shared Lane Traffic (%)												
Lane Group Flow (vph)	177	291	0	22	224	0	24	470	0	82	642	202
Turn Type	pm+pt	NA		Perm	NA		pm+pt	NA		pm+pt	NA	pm+ov
Protected Phases	7	4			8		5	2		1	6	7
Permitted Phases	4			8			2			6		6
Detector Phase	7	4		8	8		5	2		1	6	7
Switch Phase												
Minimum Initial (s)	7.0	7.0		7.0	7.0		7.0	10.0		7.0	10.0	7.0
Minimum Split (s)	13.0	31.0		32.0	32.0		13.0	23.0		13.0	22.0	13.0
Total Split (s)	23.0	57.0		34.0	34.0		13.0	50.0		13.0	50.0	23.0
Total Split (%)	19.2%	47.5%		28.3%	28.3%		10.8%	41.7%		10.8%	41.7%	19.2%
Maximum Green (s)	17.2	51.0		28.0	28.0		7.2	44.2		7.9	44.2	17.2
Yellow Time (s)	3.0	3.2		3.2	3.2		3.0	3.3		3.0	3.3	3.0
All-Red Time (s)	2.8	2.8		2.8	2.8		2.8	2.5		2.1	2.5	2.8
Lost Time Adjust (s)	-0.8	-1.0		-1.0	-1.0		-1.0	-0.8		-0.1	-0.8	-0.8
Total Lost Time (s)	5.0	5.0		5.0	5.0		4.8	5.0		5.0	5.0	5.0
Lead/Lag	Lead			Lag	Lag		Lead	Lag		Lead	Lag	Lead
Lead-Lag Optimize?												
Vehicle Extension (s)	1.0	1.0		1.0	1.0		1.0	3.0		1.0	3.0	1.0
Recall Mode	None	None		None	None		None	C-Max		None	C-Max	None
Walk Time (s)		7.0		7.0	7.0			7.0			7.0	
Flash Dont Walk (s)		18.0		19.0	19.0			10.0			9.0	
Pedestrian Calls (#/hr)		0		0	0			0			0	
Act Effect Green (s)	42.0	42.0		21.0	21.0		64.5	57.9		65.0	60.3	76.3

Lanes, Volumes, Timings

2: NC 86 (N. Columbia St) & W. Rosemary Street/E. Rosemary Street

09/01/2020



Lane Group	EBL	EBT	EBR	WBL	WBT	WBR	NBL	NBT	NBR	SBL	SBT	SBR
Actuated g/C Ratio	0.35	0.35		0.18	0.18		0.54	0.48		0.54	0.50	0.64
v/c Ratio	0.63	0.51		0.13	0.79		0.07	0.37		0.20	0.48	0.27
Control Delay	38.8	34.3		38.4	60.4		13.0	15.5		13.4	17.3	6.8
Queue Delay	0.0	0.0		0.0	0.0		0.0	0.1		0.0	0.0	0.0
Total Delay	38.8	34.3		38.4	60.4		13.0	15.6		13.4	17.3	6.8
LOS	D	C		D	E		B	B		B	B	A
Approach Delay		36.0			58.5			15.5			14.7	
Approach LOS		D			E			B			B	
Queue Length 50th (ft)	105	182		13	145		5	64		24	118	29
Queue Length 95th (ft)	139	245		35	213		m14	118		42	141	48
Internal Link Dist (ft)		677			381			273			396	
Turn Bay Length (ft)	100			150			75			150		400
Base Capacity (vph)	297	711		231	392		322	1256		404	1344	780
Starvation Cap Reductn	0	0		0	0		0	149		0	0	0
Spillback Cap Reductn	0	0		0	0		0	0		0	38	0
Storage Cap Reductn	0	0		0	0		0	0		0	0	0
Reduced v/c Ratio	0.60	0.41		0.10	0.57		0.07	0.42		0.20	0.49	0.26

Intersection Summary

Area Type: CBD
 Cycle Length: 120
 Actuated Cycle Length: 120
 Offset: 41 (34%), Referenced to phase 2:NBTL and 6:SBTL, Start of Green
 Natural Cycle: 85
 Control Type: Actuated-Coordinated
 Maximum v/c Ratio: 0.79
 Intersection Signal Delay: 24.6 Intersection LOS: C
 Intersection Capacity Utilization 64.4% ICU Level of Service C
 Analysis Period (min) 15
 m Volume for 95th percentile queue is metered by upstream signal.

Splits and Phases: 2: NC 86 (N. Columbia St) & W. Rosemary Street/E. Rosemary Street

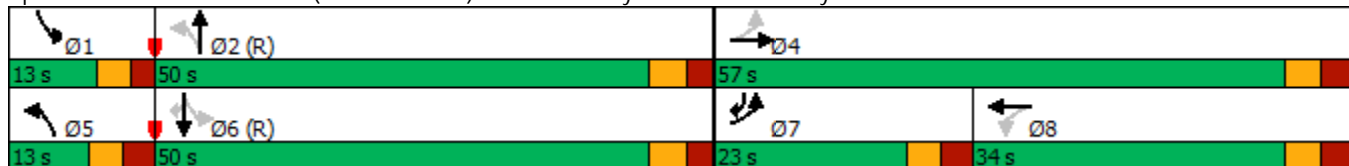

Lanes, Volumes, Timings
6: Henderson Street & E. Rosemary Street

09/01/2020



Lane Group	EBL	EBT	EBR	WBL	WBT	WBR	NBL	NBT	NBR	SBL	SBT	SBR
Lane Configurations												
Traffic Volume (vph)	5	143	63	8	270	16	77	6	8	9	17	5
Future Volume (vph)	5	143	63	8	270	16	77	6	8	9	17	5
Ideal Flow (vphpl)	1900	1900	1900	1900	1900	1900	1900	1900	1900	1900	1900	1900
Grade (%)		0%			0%			0%			3%	
Storage Length (ft)	85		0	0		0	0		0	0		0
Storage Lanes	1		0	0		0	0		0	0		0
Taper Length (ft)	25			25			25			25		
Lane Util. Factor	1.00	1.00	1.00	1.00	1.00	1.00	1.00	1.00	1.00	1.00	1.00	1.00
Ped Bike Factor	0.99	0.99			1.00			0.95			0.98	
Frt		0.954			0.993			0.988			0.979	
Flt Protected	0.950				0.999			0.959			0.986	
Satd. Flow (prot)	1593	1582	0	0	1660	0	0	1563	0	0	1561	0
Flt Permitted	0.565				0.992			0.727			0.888	
Satd. Flow (perm)	942	1582	0	0	1648	0	0	1137	0	0	1388	0
Right Turn on Red			No			No			No			No
Satd. Flow (RTOR)												
Link Speed (mph)		20			20			20			20	
Link Distance (ft)		229			1195			366			450	
Travel Time (s)		7.8			40.7			12.5			15.3	
Confl. Peds. (#/hr)	4		6	6		4	22		23	23		22
Peak Hour Factor	0.89	0.89	0.89	0.75	0.75	0.75	0.87	0.87	0.87	0.68	0.68	0.68
Heavy Vehicles (%)	2%	2%	2%	2%	2%	2%	3%	3%	3%	3%	3%	3%
Adj. Flow (vph)	6	161	71	11	360	21	89	7	9	13	25	7
Shared Lane Traffic (%)												
Lane Group Flow (vph)	6	232	0	0	392	0	0	105	0	0	45	0
Turn Type	Perm	NA		Perm	NA		Perm	NA		Perm	NA	
Protected Phases		2			2			4			4	
Permitted Phases	2			2			4			4		
Detector Phase	2	2		2	2		4	4		4	4	
Switch Phase												
Minimum Initial (s)	11.0	11.0		11.0	11.0		8.0	8.0		8.0	8.0	
Minimum Split (s)	15.9	15.9		15.9	15.9		17.8	17.8		17.8	17.8	
Total Split (s)	40.0	40.0		40.0	40.0		20.0	20.0		20.0	20.0	
Total Split (%)	66.7%	66.7%		66.7%	66.7%		33.3%	33.3%		33.3%	33.3%	
Maximum Green (s)	35.1	35.1		35.1	35.1		15.2	15.2		15.2	15.2	
Yellow Time (s)	3.3	3.3		3.3	3.3		3.3	3.3		3.3	3.3	
All-Red Time (s)	1.6	1.6		1.6	1.6		1.5	1.5		1.5	1.5	
Lost Time Adjust (s)	0.1	0.1			0.1			0.2			0.2	
Total Lost Time (s)	5.0	5.0			5.0			5.0			5.0	
Lead/Lag												
Lead-Lag Optimize?												
Vehicle Extension (s)	2.0	2.0		2.0	2.0		2.0	2.0		2.0	2.0	
Recall Mode	C-Max	C-Max		C-Max	C-Max		None	None		None	None	
Walk Time (s)	4.0	4.0		4.0	4.0		4.0	4.0		4.0	4.0	
Flash Dont Walk (s)	7.0	7.0		7.0	7.0		9.0	9.0		9.0	9.0	
Pedestrian Calls (#/hr)	0	0		0	0		0	0		0	0	
Act Effct Green (s)	43.2	43.2			43.2			10.4			10.4	
Actuated g/C Ratio	0.72	0.72			0.72			0.17			0.17	

Lanes, Volumes, Timings
 6: Henderson Street & E. Rosemary Street

09/01/2020



Lane Group	EBL	EBT	EBR	WBL	WBT	WBR	NBL	NBT	NBR	SBL	SBT	SBR
v/c Ratio	0.01	0.20			0.33			0.54				0.19
Control Delay	6.6	6.0			6.1			29.3				21.7
Queue Delay	0.0	0.0			0.0			0.0				0.0
Total Delay	6.6	6.0			6.1			29.3				21.7
LOS	A	A			A			C				C
Approach Delay		6.1			6.1			29.3				21.7
Approach LOS		A			A			C				C
Queue Length 50th (ft)	1	45			74			55				14
Queue Length 95th (ft)	m4	88			85			95				26
Internal Link Dist (ft)		149			1115			286				370
Turn Bay Length (ft)	85											
Base Capacity (vph)	677	1138			1186			284				347
Starvation Cap Reductn	0	0			0			0				0
Spillback Cap Reductn	0	0			0			0				0
Storage Cap Reductn	0	0			0			0				0
Reduced v/c Ratio	0.01	0.20			0.33			0.37				0.13

Intersection Summary

Area Type: CBD
 Cycle Length: 60
 Actuated Cycle Length: 60
 Offset: 38 (63%), Referenced to phase 2:EBWB, Start of Green
 Natural Cycle: 40
 Control Type: Actuated-Coordinated
 Maximum v/c Ratio: 0.54
 Intersection Signal Delay: 10.1
 Intersection Capacity Utilization 44.9%
 Analysis Period (min) 15
 Intersection LOS: B
 ICU Level of Service A

m Volume for 95th percentile queue is metered by upstream signal.

Splits and Phases: 6: Henderson Street & E. Rosemary Street



Lanes, Volumes, Timings

7: Hillsborough Street & E. Rosemary Street

09/01/2020



Lane Group	EBL	EBT	EBR	WBL	WBT	WBR	NBL	NBT	NBR	SBL	SBT	SBR
Lane Configurations		↕			↕		↕	↕		↕	↕	
Traffic Volume (vph)	8	58	71	0	111	12	154	143	6	21	360	44
Future Volume (vph)	8	58	71	0	111	12	154	143	6	21	360	44
Ideal Flow (vphpl)	1900	1900	1900	1900	1900	1900	1900	1900	1900	1900	1900	1900
Storage Length (ft)	0		0	0		0	100		0	100		0
Storage Lanes	0		0	0		0	1		0	1		0
Taper Length (ft)	25			25			25			25		
Lane Util. Factor	1.00	1.00	1.00	1.00	1.00	1.00	1.00	1.00	1.00	1.00	1.00	1.00
Ped Bike Factor		0.99			1.00			1.00		1.00	0.99	
Frt		0.930			0.987			0.994			0.984	
Flt Protected		0.997					0.950			0.950		
Satd. Flow (prot)	0	1704	0	0	1832	0	1752	1832	0	1752	1804	0
Flt Permitted		0.971					0.363			0.656		
Satd. Flow (perm)	0	1658	0	0	1832	0	670	1832	0	1204	1804	0
Right Turn on Red			No			No			No			No
Satd. Flow (RTOR)												
Link Speed (mph)		20			20			25			25	
Link Distance (ft)		1195			527			363			726	
Travel Time (s)		40.7			18.0			9.9			19.8	
Confl. Peds. (#/hr)	6		3	3		6	13		2	2		13
Peak Hour Factor	0.82	0.82	0.82	0.71	0.71	0.71	0.93	0.93	0.93	0.90	0.90	0.90
Heavy Vehicles (%)	2%	2%	2%	2%	2%	2%	3%	3%	3%	3%	3%	3%
Adj. Flow (vph)	10	71	87	0	156	17	166	154	6	23	400	49
Shared Lane Traffic (%)												
Lane Group Flow (vph)	0	168	0	0	173	0	166	160	0	23	449	0
Turn Type	Perm	NA			NA		pm+pt	NA		Perm	NA	
Protected Phases		4			8		5	2			6	
Permitted Phases	4			8			2			6		
Detector Phase	4	4		8	8		5	2		6	6	
Switch Phase												
Minimum Initial (s)	7.0	7.0		7.0	7.0		7.0	10.0		10.0	10.0	
Minimum Split (s)	20.0	20.0		17.0	17.0		12.0	15.0		15.0	15.0	
Total Split (s)	20.0	20.0		20.0	20.0		12.0	40.0		28.0	28.0	
Total Split (%)	33.3%	33.3%		33.3%	33.3%		20.0%	66.7%		46.7%	46.7%	
Maximum Green (s)	15.1	15.1		15.0	15.0		7.2	35.2		23.2	23.2	
Yellow Time (s)	3.0	3.0		3.3	3.3		3.0	3.3		3.1	3.1	
All-Red Time (s)	1.9	1.9		1.7	1.7		1.8	1.5		1.7	1.7	
Lost Time Adjust (s)		0.1			0.0		0.2	0.2		0.2	0.2	
Total Lost Time (s)		5.0			5.0		5.0	5.0		5.0	5.0	
Lead/Lag							Lead			Lag	Lag	
Lead-Lag Optimize?							Yes			Yes	Yes	
Vehicle Extension (s)	2.0	2.0		2.0	2.0		2.0	2.0		2.0	2.0	
Recall Mode	None	None		None	None		None	C-Max		C-Max	C-Max	
Walk Time (s)	4.0	4.0		4.0	4.0			4.0		4.0	4.0	
Flash Dont Walk (s)	11.0	11.0		8.0	8.0			6.0		6.0	6.0	
Pedestrian Calls (#/hr)	0	0		0	0			0		0	0	
Act Effct Green (s)		10.5			10.5		41.9	42.9		33.3	33.3	
Actuated g/C Ratio		0.18			0.18		0.70	0.72		0.56	0.56	
v/c Ratio		0.58			0.54		0.28	0.12		0.03	0.45	

Lanes, Volumes, Timings
 7: Hillsborough Street & E. Rosemary Street

09/01/2020



Lane Group	EBL	EBT	EBR	WBL	WBT	WBR	NBL	NBT	NBR	SBL	SBT	SBR
Control Delay		29.6			28.4		3.3	2.4		11.0	13.9	
Queue Delay		0.0			0.0		0.0	0.0		0.0	0.0	
Total Delay		29.6			28.4		3.3	2.4		11.0	13.9	
LOS		C			C		A	A		B	B	
Approach Delay		29.6			28.4			2.8				13.8
Approach LOS		C			C			A				B
Queue Length 50th (ft)		61			58		11	11		4	108	
Queue Length 95th (ft)		87			76		23	22		17	217	
Internal Link Dist (ft)		1115			447			283				646
Turn Bay Length (ft)							100			100		
Base Capacity (vph)		414			458		596	1310		667	999	
Starvation Cap Reductn		0			0		0	0		0	0	
Spillback Cap Reductn		0			0		0	0		0	0	
Storage Cap Reductn		0			0		0	0		0	0	
Reduced v/c Ratio		0.41			0.38		0.28	0.12		0.03	0.45	

Intersection Summary

Area Type:	Other
Cycle Length:	60
Actuated Cycle Length:	60
Offset:	14 (23%), Referenced to phase 2:NBTL and 6:SBTL, Start of Green
Natural Cycle:	55
Control Type:	Actuated-Coordinated
Maximum v/c Ratio:	0.58
Intersection Signal Delay:	15.2
Intersection LOS:	B
Intersection Capacity Utilization	57.4%
ICU Level of Service	B
Analysis Period (min)	15

Splits and Phases: 7: Hillsborough Street & E. Rosemary Street



Lanes, Volumes, Timings

8: Carolina Square Driveway/Church Street & W. Franklin Street

09/01/2020



Lane Group	EBL	EBT	EBR	WBL	WBT	WBR	NBL	NBT	NBR	SBL	SBT	SBR
Lane Configurations												
Traffic Volume (vph)	55	345	23	10	251	43	2	5	10	20	20	50
Future Volume (vph)	55	345	23	10	251	43	2	5	10	20	20	50
Ideal Flow (vphpl)	1900	1900	1900	1900	1900	1900	1900	1900	1900	1900	1900	1900
Lane Width (ft)	10	10	16	10	10	10	12	12	12	12	12	12
Grade (%)		2%			-2%			-4%				-3%
Storage Length (ft)	150		0	200		0	0		100	0		0
Storage Lanes	1		0	1		0	0		1	0		0
Taper Length (ft)	25			25			25			25		
Lane Util. Factor	1.00	1.00	1.00	1.00	1.00	1.00	1.00	1.00	1.00	1.00	1.00	1.00
Ped Bike Factor	0.95	0.99		0.95	0.98			0.98	0.94		0.94	
Frt		0.991			0.978				0.850		0.926	
Flt Protected	0.950			0.950				0.985			0.989	
Satd. Flow (prot)	1430	1480	0	1431	1450	0	0	1621	1399	0	1431	0
Flt Permitted	0.549			0.495				0.885			0.919	
Satd. Flow (perm)	786	1480	0	710	1450	0	0	1424	1316	0	1318	0
Right Turn on Red			No			No			No			No
Satd. Flow (RTOR)												
Link Speed (mph)		20			20			20			25	
Link Distance (ft)		993			298			285			379	
Travel Time (s)		33.9			10.2			9.7			10.3	
Confl. Peds. (#/hr)	39		57	57		39	57		29	29		57
Peak Hour Factor	0.84	0.84	0.84	0.83	0.83	0.83	0.53	0.53	0.53	0.92	0.92	0.92
Heavy Vehicles (%)	5%	5%	5%	7%	7%	7%	6%	6%	6%	5%	5%	5%
Adj. Flow (vph)	65	411	27	12	302	52	4	9	19	22	22	54
Shared Lane Traffic (%)												
Lane Group Flow (vph)	65	438	0	12	354	0	0	13	19	0	98	0
Turn Type	Perm	NA		Perm	NA		Perm	NA	Perm	Perm	NA	
Protected Phases		2			6			8				4
Permitted Phases	2			6			8		8	4		
Detector Phase	2	2		6	6		8	8	8	4	4	
Switch Phase												
Minimum Initial (s)	10.0	10.0		10.0	10.0		7.0	7.0	7.0	7.0	7.0	
Minimum Split (s)	22.0	22.0		19.0	19.0		29.0	29.0	29.0	27.0	27.0	
Total Split (s)	31.0	31.0		31.0	31.0		29.0	29.0	29.0	29.0	29.0	
Total Split (%)	51.7%	51.7%		51.7%	51.7%		48.3%	48.3%	48.3%	48.3%	48.3%	
Maximum Green (s)	25.4	25.4		25.4	25.4		22.7	22.7	22.7	23.0	23.0	
Yellow Time (s)	3.3	3.3		3.3	3.3		3.1	3.1	3.1	3.4	3.4	
All-Red Time (s)	2.3	2.3		2.3	2.3		3.2	3.2	3.2	2.6	2.6	
Lost Time Adjust (s)	-0.6	-0.6		-0.6	-0.6		-1.3	-1.3	-1.3	-1.0	-1.0	
Total Lost Time (s)	5.0	5.0		5.0	5.0		5.0	5.0	5.0	5.0	5.0	
Lead/Lag												
Lead-Lag Optimize?												
Vehicle Extension (s)	3.0	3.0		3.0	3.0		2.0	2.0	2.0	2.0	2.0	
Recall Mode	C-Max	C-Max		C-Max	C-Max		None	None	None	None	None	
Walk Time (s)	7.0	7.0		7.0	7.0		7.0	7.0	7.0	7.0	7.0	
Flash Dont Walk (s)	9.0	9.0		6.0	6.0		15.0	15.0	15.0	14.0	14.0	
Pedestrian Calls (#/hr)	0	0		0	0		0	0	0	0	0	
Act Effect Green (s)	43.3	43.3		43.3	43.3		10.4	10.4	10.4	10.3	10.3	

Lanes, Volumes, Timings

8: Carolina Square Driveway/Church Street & W. Franklin Street

09/01/2020



Lane Group	EBL	EBT	EBR	WBL	WBT	WBR	NBL	NBT	NBR	SBL	SBT	SBR
Actuated g/C Ratio	0.72	0.72		0.72	0.72			0.17	0.17			0.17
v/c Ratio	0.11	0.41		0.02	0.34			0.05	0.08			0.43
Control Delay	5.1	6.6		1.9	3.7			19.6	20.2			25.6
Queue Delay	0.0	0.0		0.0	0.0			0.0	0.0			0.0
Total Delay	5.1	6.6		1.9	3.7			19.6	20.2			25.6
LOS	A	A		A	A			B	C			C
Approach Delay		6.4			3.6			19.9				25.6
Approach LOS		A			A			B				C
Queue Length 50th (ft)	7	59		2	80			4	6			35
Queue Length 95th (ft)	22	124		m1	m28			9	11			57
Internal Link Dist (ft)		913			218			205				299
Turn Bay Length (ft)	150			200					100			
Base Capacity (vph)	567	1067		512	1045			569	526			527
Starvation Cap Reductn	0	0		0	0			0	0			0
Spillback Cap Reductn	0	0		0	0			0	0			0
Storage Cap Reductn	0	0		0	0			0	0			0
Reduced v/c Ratio	0.11	0.41		0.02	0.34			0.02	0.04			0.19

Intersection Summary

Area Type: CBD
 Cycle Length: 60
 Actuated Cycle Length: 60
 Offset: 42 (70%), Referenced to phase 2:EBTL and 6:WBTL, Start of Green
 Natural Cycle: 60
 Control Type: Actuated-Coordinated
 Maximum v/c Ratio: 0.43
 Intersection Signal Delay: 7.7 Intersection LOS: A
 Intersection Capacity Utilization 64.2% ICU Level of Service C
 Analysis Period (min) 15
 m Volume for 95th percentile queue is metered by upstream signal.

Splits and Phases: 8: Carolina Square Driveway/Church Street & W. Franklin Street

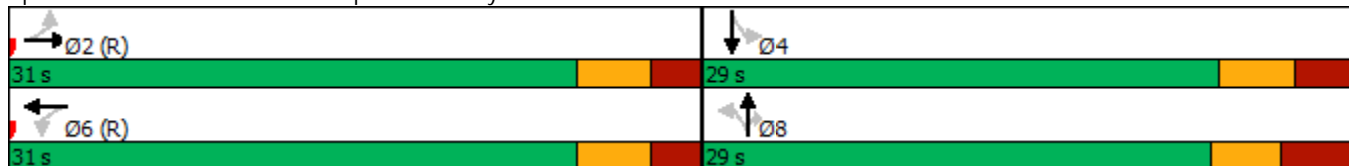

Lanes, Volumes, Timings

9: NC 86 (S. Columbia St)/NC 86 (N. Columbia St) & W. Franklin Street/E. Franklin Street 09/01/2020



Lane Group	EBL	EBT	EBR	WBL	WBT	WBR	NBL	NBT	NBR	SBL	SBT	SBR
Lane Configurations												
Traffic Volume (vph)	77	286	29	66	278	46	30	344	88	36	468	81
Future Volume (vph)	77	286	29	66	278	46	30	344	88	36	468	81
Ideal Flow (vphpl)	1900	1900	1900	1900	1900	1900	1900	1900	1900	1900	1900	1900
Lane Width (ft)	9	12	13	10	10	13	9	10	10	9	9	11
Grade (%)		3%			1%			-2%			3%	
Storage Length (ft)	250		0	125		0	475		0	125		0
Storage Lanes	1		0	1		1	1		0	1		0
Taper Length (ft)	25			25			25			25		
Lane Util. Factor	1.00	0.95	0.95	1.00	1.00	1.00	1.00	0.95	0.95	1.00	0.95	0.95
Ped Bike Factor	0.87	0.99		0.95		0.79	0.97	0.97		0.92	0.99	
Frt		0.986				0.850		0.969			0.978	
Flt Protected	0.950			0.950			0.950			0.950		
Satd. Flow (prot)	1372	2980	0	1410	1484	1397	1342	2605	0	1346	2595	0
Flt Permitted	0.950			0.950			0.950			0.950		
Satd. Flow (perm)	1192	2980	0	1345	1484	1100	1299	2605	0	1233	2595	0
Right Turn on Red			No			No			No			No
Satd. Flow (RTOR)												
Link Speed (mph)		20			20			25			25	
Link Distance (ft)		457			941			981			353	
Travel Time (s)		15.6			32.1			26.8			9.6	
Confl. Peds. (#/hr)	125		49	49		125	29		98	98		29
Peak Hour Factor	0.80	0.80	0.80	0.87	0.87	0.87	0.93	0.93	0.93	0.85	0.85	0.85
Heavy Vehicles (%)	5%	5%	5%	7%	7%	7%	10%	10%	10%	7%	7%	7%
Adj. Flow (vph)	96	358	36	76	320	53	32	370	95	42	551	95
Shared Lane Traffic (%)												
Lane Group Flow (vph)	96	394	0	76	320	53	32	465	0	42	646	0
Turn Type	Prot	NA		Prot	NA	pm+ov	Prot	NA		Prot	NA	
Protected Phases	5	2		1	6	7	3	8		7	4	
Permitted Phases						6						
Detector Phase	5	2		1	6	7	3	8		7	4	
Switch Phase												
Minimum Initial (s)	7.0	10.0		7.0	10.0	7.0	7.0	7.0		7.0	7.0	
Minimum Split (s)	15.0	28.2		15.0	28.2	15.0	15.0	28.0		15.0	28.1	
Total Split (s)	22.0	38.0		22.0	38.0	22.0	22.0	38.0		22.0	38.0	
Total Split (%)	18.3%	31.7%		18.3%	31.7%	18.3%	18.3%	31.7%		18.3%	31.7%	
Maximum Green (s)	16.6	31.8		16.1	31.8	16.1	16.1	32.1		16.1	32.3	
Yellow Time (s)	3.0	3.0		3.0	3.0	3.0	3.0	3.3		3.0	3.1	
All-Red Time (s)	2.4	3.2		2.9	3.2	2.9	2.9	2.6		2.9	2.6	
Lost Time Adjust (s)	-0.4	-1.2		-0.9	-1.2	-2.0	-0.9	-0.9		-0.9	-0.7	
Total Lost Time (s)	5.0	5.0		5.0	5.0	3.9	5.0	5.0		5.0	5.0	
Lead/Lag	Lead	Lag		Lead	Lag	Lead	Lead	Lag		Lead	Lag	
Lead-Lag Optimize?												
Vehicle Extension (s)	1.0	3.0		1.0	3.0	1.0	1.0	2.0		1.0	2.0	
Recall Mode	None	C-Max		None	C-Max	None	None	Ped		None	Ped	
Walk Time (s)		7.0			7.0			7.0			7.0	
Flash Dont Walk (s)		15.0			15.0			15.0			15.0	
Pedestrian Calls (#/hr)		0			0			0			0	
Act Effect Green (s)	12.2	52.2		11.2	48.6	60.0	8.6	32.6		9.2	35.7	

Lanes, Volumes, Timings

9: NC 86 (S. Columbia St)/NC 86 (N. Columbia St) & W. Franklin Street/E. Franklin Street 09/01/2020



Lane Group	EBL	EBT	EBR	WBL	WBT	WBR	NBL	NBT	NBR	SBL	SBT	SBR
Actuated g/C Ratio	0.10	0.44		0.09	0.40	0.50	0.07	0.27		0.08	0.30	
v/c Ratio	0.69	0.30		0.58	0.53	0.09	0.33	0.66		0.41	0.84	
Control Delay	80.1	24.0		78.9	23.7	9.3	83.6	20.9		92.4	26.6	
Queue Delay	0.0	0.0		0.0	0.0	0.0	0.0	0.0		0.0	0.1	
Total Delay	80.1	24.0		78.9	23.7	9.3	83.6	20.9		92.4	26.7	
LOS	F	C		E	C	A	F	C		F	C	
Approach Delay		35.0			31.3			24.9			30.7	
Approach LOS		C			C			C			C	
Queue Length 50th (ft)	76	96		62	95	11	18	174		31	177	
Queue Length 95th (ft)	120	140		111	#173	19	m42	154		71	82	
Internal Link Dist (ft)		377			861			901			273	
Turn Bay Length (ft)	250			125			475			125		
Base Capacity (vph)	194	1295		199	601	666	190	766		190	791	
Starvation Cap Reductn	0	0		0	0	0	0	0		0	6	
Spillback Cap Reductn	0	0		0	0	0	0	0		0	0	
Storage Cap Reductn	0	0		0	0	0	0	0		0	0	
Reduced v/c Ratio	0.49	0.30		0.38	0.53	0.08	0.17	0.61		0.22	0.82	

Intersection Summary

Area Type: CBD
 Cycle Length: 120
 Actuated Cycle Length: 120
 Offset: 0 (0%), Referenced to phase 2:EBT and 6:WBT, Start of Green
 Natural Cycle: 90
 Control Type: Actuated-Coordinated
 Maximum v/c Ratio: 0.84
 Intersection Signal Delay: 30.5 Intersection LOS: C
 Intersection Capacity Utilization 65.0% ICU Level of Service C
 Analysis Period (min) 15
 # 95th percentile volume exceeds capacity, queue may be longer.
 Queue shown is maximum after two cycles.
 m Volume for 95th percentile queue is metered by upstream signal.

Splits and Phases: 9: NC 86 (S. Columbia St)/NC 86 (N. Columbia St) & W. Franklin Street/E. Franklin Street

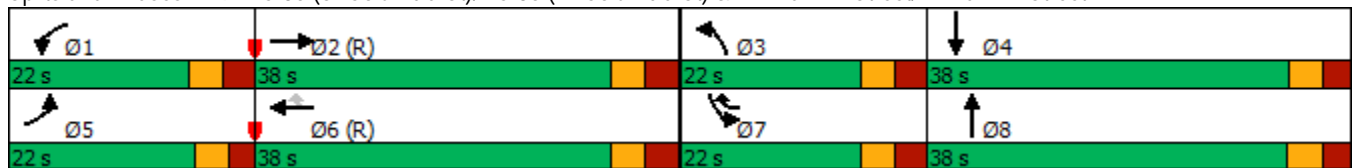

Lanes, Volumes, Timings
 10: E. Franklin Street & Henderson Street

09/01/2020



Lane Group	EBL	EBT	WBT	WBR	SBL	SBR
Lane Configurations		↕↕	↕↔		↔↕	
Traffic Volume (vph)	15	370	388	87	68	17
Future Volume (vph)	15	370	388	87	68	17
Ideal Flow (vphpl)	1900	1900	1900	1900	1900	1900
Lane Width (ft)	10	13	10	10	11	11
Grade (%)		-2%	2%		3%	
Lane Util. Factor	0.95	0.95	0.95	0.95	1.00	1.00
Ped Bike Factor		1.00	0.99		0.95	
Frt			0.972		0.972	
Flt Protected		0.998			0.962	
Satd. Flow (prot)	0	3223	2743	0	1436	0
Flt Permitted		0.932			0.962	
Satd. Flow (perm)	0	3007	2743	0	1389	0
Right Turn on Red				No		No
Satd. Flow (RTOR)						
Link Speed (mph)		20	20		20	
Link Distance (ft)		941	1200		366	
Travel Time (s)		32.1	40.9		12.5	
Confl. Peds. (#/hr)	26			26	44	87
Peak Hour Factor	0.91	0.91	0.90	0.90	0.79	0.79
Heavy Vehicles (%)	5%	5%	5%	5%	4%	4%
Parking (#/hr)						0
Adj. Flow (vph)	16	407	431	97	86	22
Shared Lane Traffic (%)						
Lane Group Flow (vph)	0	423	528	0	108	0
Turn Type	Perm	NA	NA		Prot	
Protected Phases		2	6		4	
Permitted Phases	2					
Detector Phase	2	2	6		4	
Switch Phase						
Minimum Initial (s)	10.0	10.0	10.0		7.0	
Minimum Split (s)	17.0	17.0	22.0		25.0	
Total Split (s)	32.0	32.0	32.0		28.0	
Total Split (%)	53.3%	53.3%	53.3%		46.7%	
Maximum Green (s)	25.8	25.8	25.9		22.9	
Yellow Time (s)	3.0	3.0	3.0		3.0	
All-Red Time (s)	3.2	3.2	3.1		2.1	
Lost Time Adjust (s)		-1.2	-1.1		-0.1	
Total Lost Time (s)		5.0	5.0		5.0	
Lead/Lag						
Lead-Lag Optimize?						
Vehicle Extension (s)	2.0	2.0	2.0		1.0	
Recall Mode	C-Max	C-Max	C-Max		None	
Walk Time (s)			7.0		7.0	
Flash Dont Walk (s)			8.0		12.0	
Pedestrian Calls (#/hr)			0		0	
Act Effct Green (s)		44.5	44.5		8.9	
Actuated g/C Ratio		0.74	0.74		0.15	
v/c Ratio		0.19	0.26		0.51	

Lanes, Volumes, Timings
 10: E. Franklin Street & Henderson Street

09/01/2020



Lane Group	EBL	EBT	WBT	WBR	SBL	SBR
Control Delay		6.8	3.9		29.4	
Queue Delay		0.0	0.0		0.0	
Total Delay		6.8	3.9		29.4	
LOS		A	A		C	
Approach Delay		6.8	3.9		29.4	
Approach LOS		A	A		C	
Queue Length 50th (ft)		108	125		33	
Queue Length 95th (ft)		154	19		55	
Internal Link Dist (ft)		861	1120		286	
Turn Bay Length (ft)						
Base Capacity (vph)		2229	2033		550	
Starvation Cap Reductn		0	0		0	
Spillback Cap Reductn		0	0		0	
Storage Cap Reductn		0	0		0	
Reduced v/c Ratio		0.19	0.26		0.20	

Intersection Summary

Area Type:	CBD
Cycle Length:	60
Actuated Cycle Length:	60
Offset:	53 (88%), Referenced to phase 2:EBTL and 6:WBT, Start of Green
Natural Cycle:	50
Control Type:	Actuated-Coordinated
Maximum v/c Ratio:	0.51
Intersection Signal Delay:	7.7
Intersection LOS:	A
Intersection Capacity Utilization:	47.2%
ICU Level of Service:	A
Analysis Period (min):	15

Splits and Phases: 10: E. Franklin Street & Henderson Street

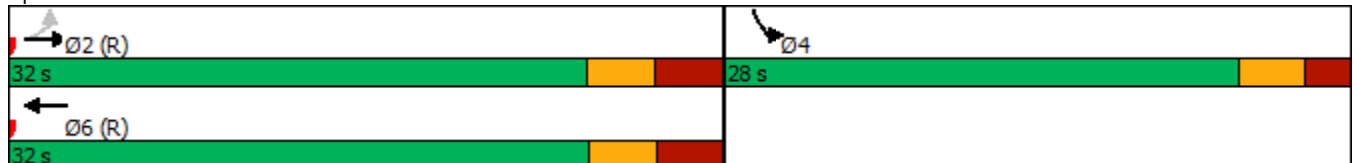

Lanes, Volumes, Timings

11: Raleigh Street/Hillsborough Street & E. Franklin Street

09/01/2020



Lane Group	EBL	EBT	EBR	WBL	WBT	WBR	NBL	NBT	NBR	SBL	SBT	SBR
Lane Configurations	↖	↕		↖	↕			↕		↖	↕	
Traffic Volume (vph)	19	317	105	42	432	97	85	180	23	70	340	18
Future Volume (vph)	19	317	105	42	432	97	85	180	23	70	340	18
Ideal Flow (vphpl)	1900	1900	1900	1900	1900	1900	1900	1900	1900	1900	1900	1900
Lane Width (ft)	9	9	10	9	10	11	12	12	12	10	10	10
Grade (%)		1%			-2%			1%			1%	
Storage Length (ft)	75		0	75		0	0		0	100		0
Storage Lanes	1		0	1		0	0		0	1		0
Taper Length (ft)	25			25			25			25		
Lane Util. Factor	1.00	0.95	0.95	1.00	0.95	0.95	1.00	1.00	1.00	1.00	1.00	1.00
Ped Bike Factor	0.99	0.99		0.99	0.99			0.99		0.99	1.00	
Frt		0.963			0.973			0.989			0.992	
Flt Protected	0.950			0.950				0.986		0.950		
Satd. Flow (prot)	1539	2934	0	1578	3165	0	0	1768	0	1627	1695	0
Flt Permitted	0.375			0.425				0.650		0.504		
Satd. Flow (perm)	605	2934	0	698	3165	0	0	1161	0	856	1695	0
Right Turn on Red			No			No			No			No
Satd. Flow (RTOR)												
Link Speed (mph)		20			30			25			25	
Link Distance (ft)		1200			1013			995			363	
Travel Time (s)		40.9			23.0			27.1			9.9	
Confl. Peds. (#/hr)	9		16	16		9	25		11	11		25
Peak Hour Factor	0.86	0.86	0.86	0.92	0.92	0.92	0.83	0.83	0.83	0.96	0.96	0.96
Heavy Vehicles (%)	5%	5%	5%	4%	4%	4%	4%	4%	4%	3%	3%	3%
Adj. Flow (vph)	22	369	122	46	470	105	102	217	28	73	354	19
Shared Lane Traffic (%)												
Lane Group Flow (vph)	22	491	0	46	575	0	0	347	0	73	373	0
Turn Type	Perm	NA		Perm	NA		pm+pt	NA		D.Pm	NA	
Protected Phases		2			6		7	4				8
Permitted Phases	2			6			4			4		
Detector Phase	2	2		6	6		7	4		4		8
Switch Phase												
Minimum Initial (s)	10.0	10.0		10.0	10.0		7.0	7.0		7.0	7.0	
Minimum Split (s)	16.0	16.0		16.0	16.0		14.0	30.0		30.0	29.0	
Total Split (s)	47.0	47.0		47.0	47.0		28.0	73.0		73.0	45.0	
Total Split (%)	39.2%	39.2%		39.2%	39.2%		23.3%	60.8%		60.8%	37.5%	
Maximum Green (s)	41.7	41.7		41.7	41.7		21.8	66.6		66.6	38.6	
Yellow Time (s)	3.0	3.0		3.0	3.0		3.0	3.1		3.1	3.1	
All-Red Time (s)	2.3	2.3		2.3	2.3		3.2	3.3		3.3	3.3	
Lost Time Adjust (s)	-0.3	-0.3		-0.3	-0.3			-1.4		-1.4	-1.4	
Total Lost Time (s)	5.0	5.0		5.0	5.0			5.0		5.0	5.0	
Lead/Lag							Lead				Lag	
Lead-Lag Optimize?												
Vehicle Extension (s)	3.0	3.0		3.0	3.0		3.0	2.0		2.0	2.0	
Recall Mode	C-Max	C-Max		C-Max	C-Max		None	None		None	None	
Walk Time (s)								7.0		7.0	7.0	
Flash Dont Walk (s)								16.0		16.0	15.0	
Pedestrian Calls (#/hr)								0		0	0	
Act Effect Green (s)	56.4	56.4		56.4	56.4			53.6		53.6	53.6	

Lanes, Volumes, Timings

11: Raleigh Street/Hillsborough Street & E. Franklin Street

09/01/2020



Lane Group	EBL	EBT	EBR	WBL	WBT	WBR	NBL	NBT	NBR	SBL	SBT	SBR
Actuated g/C Ratio	0.47	0.47		0.47	0.47			0.45		0.45	0.45	
v/c Ratio	0.08	0.36		0.14	0.39			0.67		0.19	0.49	
Control Delay	15.5	14.9		24.9	24.0			31.5		15.3	21.4	
Queue Delay	0.0	0.0		0.0	0.0			0.0		0.0	2.1	
Total Delay	15.5	14.9		24.9	24.0			31.5		15.3	23.5	
LOS	B	B		C	C			C		B	C	
Approach Delay		14.9			24.0			31.5			22.2	
Approach LOS		B			C			C			C	
Queue Length 50th (ft)	6	72		20	152			203		32	189	
Queue Length 95th (ft)	15	88		56	242			216		53	225	
Internal Link Dist (ft)		1120			933			915			283	
Turn Bay Length (ft)	75			75						100		
Base Capacity (vph)	284	1379		328	1488			657		485	769	
Starvation Cap Reductn	0	0		0	0			0		0	256	
Spillback Cap Reductn	0	0		0	0			0		0	0	
Storage Cap Reductn	0	0		0	0			0		0	0	
Reduced v/c Ratio	0.08	0.36		0.14	0.39			0.53		0.15	0.73	

Intersection Summary

Area Type:	Other
Cycle Length:	120
Actuated Cycle Length:	120
Offset:	61 (51%), Referenced to phase 2:EBTL and 6:WBTL, Start of Green
Natural Cycle:	60
Control Type:	Actuated-Coordinated
Maximum v/c Ratio:	0.67
Intersection Signal Delay:	22.5
Intersection LOS:	C
Intersection Capacity Utilization	76.0%
ICU Level of Service	D
Analysis Period (min)	15

Splits and Phases: 11: Raleigh Street/Hillsborough Street & E. Franklin Street

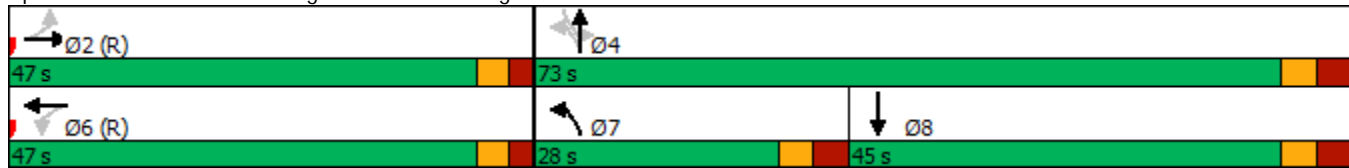

Lanes, Volumes, Timings

13: NC 86 (N. Columbia St)/NC 86 (MLK Jr. Blvd) & North Street & N. Columbia Street 09/01/2020



Lane Group	WBL	WBR	WBR2	NBL	NBT	NBR	SBL	SBT	SBR	SEL2	SEL	SER
Lane Configurations												
Traffic Volume (vph)	2	3	20	38	441	3	77	765	2	2	6	55
Future Volume (vph)	2	3	20	38	441	3	77	765	2	2	6	55
Ideal Flow (vphpl)	1900	1900	1900	1900	1900	1900	1900	1900	1900	1900	1900	1900
Grade (%)	2%				-5%				5%			
Storage Length (ft)	0	50		150		0	70		0		0	0
Storage Lanes	1	1		1		0	1		0		1	0
Taper Length (ft)	25			25			25				25	
Lane Util. Factor	1.00	1.00	1.00	1.00	0.95	0.95	1.00	0.95	0.95	1.00	1.00	1.00
Ped Bike Factor				1.00	1.00		0.99	1.00				
Frt	0.910		0.850		0.999							0.883
Flt Protected	0.980			0.950			0.950					0.993
Satd. Flow (prot)	1525	0	1454	1729	3454	0	1676	3352	0	0	1566	0
Flt Permitted	0.980			0.299			0.473				0.993	
Satd. Flow (perm)	1525	0	1454	544	3454	0	829	3352	0	0	1566	0
Right Turn on Red			No			No			No			No
Satd. Flow (RTOR)												
Link Speed (mph)	20				35				35			
Link Distance (ft)	263				476				2108			
Travel Time (s)	9.0				9.3				41.1			
Confl. Peds. (#/hr)				1		15	15		1			
Peak Hour Factor	0.48	0.48	0.48	0.93	0.93	0.93	0.89	0.89	0.89	0.76	0.76	0.76
Heavy Vehicles (%)	10%	10%	10%	7%	7%	7%	5%	5%	5%	8%	8%	8%
Adj. Flow (vph)	4	6	42	41	474	3	87	860	2	3	8	72
Shared Lane Traffic (%)												
Lane Group Flow (vph)	10	0	42	41	477	0	87	862	0	0	83	0
Turn Type	Prot		Perm	Perm	NA		Perm	NA		Prot	Prot	
Protected Phases	3				2			6		4	4	
Permitted Phases			3	2			6					
Detector Phase	3		3	2	2		6	6		4	4	
Switch Phase												
Minimum Initial (s)	7.0		7.0	10.0	10.0		10.0	10.0		7.0	7.0	
Minimum Split (s)	14.0		14.0	17.0	17.0		17.0	17.0		14.0	14.0	
Total Split (s)	23.0		23.0	70.0	70.0		70.0	70.0		27.0	27.0	
Total Split (%)	19.2%		19.2%	58.3%	58.3%		58.3%	58.3%		22.5%	22.5%	
Maximum Green (s)	16.0		16.0	63.0	63.0		63.0	63.0		20.0	20.0	
Yellow Time (s)	5.0		5.0	5.0	5.0		5.0	5.0		5.0	5.0	
All-Red Time (s)	2.0		2.0	2.0	2.0		2.0	2.0		2.0	2.0	
Lost Time Adjust (s)	-2.0		-2.0	-2.0	-2.0		-2.0	-2.0			-2.0	
Total Lost Time (s)	5.0		5.0	5.0	5.0		5.0	5.0			5.0	
Lead/Lag	Lead		Lead							Lag	Lag	
Lead-Lag Optimize?	Yes		Yes							Yes	Yes	
Vehicle Extension (s)	3.0		3.0	3.0	3.0		3.0	3.0		3.0	3.0	
Recall Mode	None		None	C-Max	C-Max		C-Max	C-Max		None	None	
Act Effct Green (s)	11.2		11.2	86.7	86.7		86.7	86.7			13.7	
Actuated g/C Ratio	0.09		0.09	0.72	0.72		0.72	0.72			0.11	
v/c Ratio	0.07		0.31	0.10	0.19		0.15	0.36			0.47	
Control Delay	49.2		56.1	4.2	3.2		9.2	9.3			57.4	
Queue Delay	0.0		0.0	0.0	0.0		0.0	0.0			0.0	

Lanes, Volumes, Timings

13: NC 86 (N. Columbia St)/NC 86 (MLK Jr. Blvd) & North Street & N. Columbia Street 09/01/2020



Lane Group	WBL	WBR	WBR2	NBL	NBT	NBR	SBL	SBT	SBR	SEL2	SEL	SER
Total Delay	49.2		56.1	4.2	3.2		9.2	9.3			57.4	
LOS	D		E	A	A		A	A			E	
Approach Delay	54.8				3.3			9.3			57.4	
Approach LOS	D				A			A			E	
Queue Length 50th (ft)	7		31	4	25		23	142			61	
Queue Length 95th (ft)	13		34	m9	34		54	220			90	
Internal Link Dist (ft)	183				396			2028			635	
Turn Bay Length (ft)			50	150			70					
Base Capacity (vph)	228		218	393	2495		599	2421			287	
Starvation Cap Reductn	0		0	0	0		0	0			0	
Spillback Cap Reductn	0		0	0	0		0	0			0	
Storage Cap Reductn	0		0	0	0		0	0			0	
Reduced v/c Ratio	0.04		0.19	0.10	0.19		0.15	0.36			0.29	

Intersection Summary

Area Type: Other
 Cycle Length: 120
 Actuated Cycle Length: 120
 Offset: 53 (44%), Referenced to phase 2:NBTL and 6:SBTL, Start of Green
 Natural Cycle: 50
 Control Type: Actuated-Coordinated
 Maximum v/c Ratio: 0.47
 Intersection Signal Delay: 11.3 Intersection LOS: B
 Intersection Capacity Utilization 57.9% ICU Level of Service B
 Analysis Period (min) 15
 m Volume for 95th percentile queue is metered by upstream signal.

Splits and Phases: 13: NC 86 (N. Columbia St)/NC 86 (MLK Jr. Blvd) & North Street & N. Columbia Street

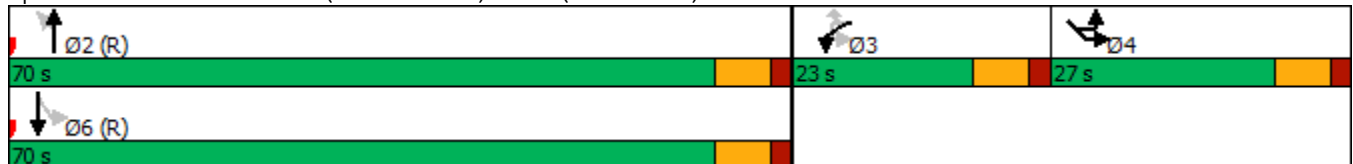

Lanes, Volumes, Timings

14: NC 86 (MLK Jr. Blvd) & Longview Street/Mill Creek Apts Driveway

09/01/2020



Lane Group	EBL	EBT	EBR	WBL	WBT	WBR	NBL	NBT	NBR	SBL	SBT	SBR
Lane Configurations		↕			↕		↕	↕		↕	↕	
Traffic Volume (vph)	78	0	10	6	0	5	2	439	5	0	755	67
Future Volume (vph)	78	0	10	6	0	5	2	439	5	0	755	67
Ideal Flow (vphpl)	1900	1900	1900	1900	1900	1900	1900	1900	1900	1900	1900	1900
Grade (%)		-6%			1%			2%			-4%	
Storage Length (ft)	0		0	0		0	225		0	250		0
Storage Lanes	0		0	0		0	1		0	1		0
Taper Length (ft)	25			25			25			25		
Lane Util. Factor	1.00	1.00	1.00	1.00	1.00	1.00	1.00	0.95	0.95	1.00	0.95	0.95
Ped Bike Factor		1.00			0.99		1.00	1.00			1.00	
Frt		0.985			0.944			0.998			0.988	
Flt Protected		0.958			0.972		0.950					
Satd. Flow (prot)	0	1737	0	0	1701	0	1686	3364	0	1846	3456	0
Flt Permitted		0.741			0.817		0.246					
Satd. Flow (perm)	0	1343	0	0	1420	0	436	3364	0	1846	3456	0
Right Turn on Red			No			No			No			No
Satd. Flow (RTOR)												
Link Speed (mph)		25			20			35			35	
Link Distance (ft)		451			338			2108			784	
Travel Time (s)		12.3			11.5			41.1			15.3	
Confl. Peds. (#/hr)			16	16			4		4	4		4
Peak Hour Factor	0.52	0.52	0.52	0.92	0.92	0.92	0.93	0.93	0.93	0.84	0.84	0.84
Heavy Vehicles (%)	6%	6%	6%	2%	2%	2%	6%	6%	6%	5%	5%	5%
Adj. Flow (vph)	150	0	19	7	0	5	2	472	5	0	899	80
Shared Lane Traffic (%)												
Lane Group Flow (vph)	0	169	0	0	12	0	2	477	0	0	979	0
Turn Type	Perm	NA		Perm	NA		Perm	NA		Perm	NA	
Protected Phases		4			8			2			6	
Permitted Phases	4			8			2			6		
Detector Phase	4	4		8	8		2	2		6	6	
Switch Phase												
Minimum Initial (s)	7.0	7.0		7.0	7.0		12.0	12.0		12.0	12.0	
Minimum Split (s)	31.0	31.0		14.0	14.0		28.0	28.0		28.0	28.0	
Total Split (s)	20.0	20.0		20.0	20.0		60.0	60.0		60.0	60.0	
Total Split (%)	25.0%	25.0%		25.0%	25.0%		75.0%	75.0%		75.0%	75.0%	
Maximum Green (s)	14.0	14.0		13.9	13.9		54.0	54.0		54.5	54.5	
Yellow Time (s)	3.5	3.5		3.0	3.0		4.5	4.5		4.0	4.0	
All-Red Time (s)	2.5	2.5		3.1	3.1		1.5	1.5		1.5	1.5	
Lost Time Adjust (s)		-1.0			-1.0		-1.0	-1.0		-0.5	-0.5	
Total Lost Time (s)		5.0			5.1		5.0	5.0		5.0	5.0	
Lead/Lag												
Lead-Lag Optimize?												
Vehicle Extension (s)	3.0	3.0		3.0	3.0		3.0	3.0		3.0	3.0	
Recall Mode	None	None		None	None		Min	Min		Min	Min	
Walk Time (s)	7.0	7.0					7.0	7.0		7.0	7.0	
Flash Dont Walk (s)	17.0	17.0					9.0	9.0		9.0	9.0	
Pedestrian Calls (#/hr)	0	0					0	0		0	0	
Act Effct Green (s)		12.0			11.9		23.8	23.8			23.8	
Actuated g/C Ratio		0.26			0.26		0.52	0.52			0.52	

Lanes, Volumes, Timings

14: NC 86 (MLK Jr. Blvd) & Longview Street/Mill Creek Apts Driveway

09/01/2020



Lane Group	EBL	EBT	EBR	WBL	WBT	WBR	NBL	NBT	NBR	SBL	SBT	SBR
v/c Ratio		0.48			0.03		0.01	0.27				0.55
Control Delay		19.5			13.3		6.0	7.1				9.2
Queue Delay		0.0			0.0		0.0	0.0				0.0
Total Delay		19.5			13.3		6.0	7.1				9.2
LOS		B			B		A	A				A
Approach Delay		19.5			13.3			7.0				9.2
Approach LOS		B			B			A				A
Queue Length 50th (ft)		34			2		0	32				79
Queue Length 95th (ft)		46			12		3	61				124
Internal Link Dist (ft)		371			258			2028				704
Turn Bay Length (ft)							225					
Base Capacity (vph)		444			466		436	3364				3456
Starvation Cap Reductn		0			0		0	0				0
Spillback Cap Reductn		0			0		0	0				0
Storage Cap Reductn		0			0		0	0				0
Reduced v/c Ratio		0.38			0.03		0.00	0.14				0.28

Intersection Summary

Area Type:	Other
Cycle Length:	80
Actuated Cycle Length:	45.9
Natural Cycle:	60
Control Type:	Actuated-Uncoordinated
Maximum v/c Ratio:	0.55
Intersection Signal Delay:	9.7
Intersection LOS:	A
Intersection Capacity Utilization:	44.2%
ICU Level of Service:	A
Analysis Period (min):	15

Splits and Phases: 14: NC 86 (MLK Jr. Blvd) & Longview Street/Mill Creek Apts Driveway

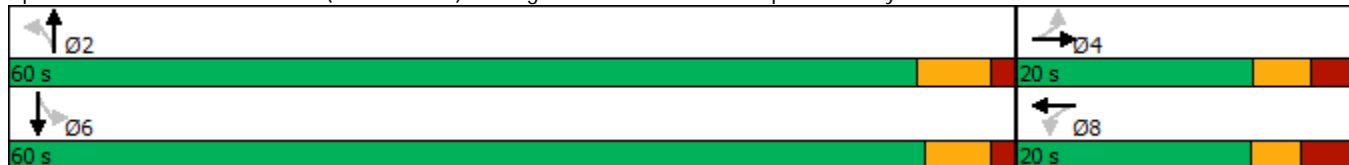

Lanes, Volumes, Timings
 15: NC 86 (Pittsboro St) & W. Cameron Avenue

09/01/2020



Lane Group	EBT	EBR	WBL	WBT	NBL	NBR	Ø1	Ø4
Lane Configurations	↻		↻↻	↻				
Traffic Volume (vph)	120	161	610	135	0	0		
Future Volume (vph)	120	161	610	135	0	0		
Ideal Flow (vphpl)	1900	1900	1900	1900	1900	1900		
Lane Width (ft)	12	12	11	12	12	12		
Grade (%)	3%			-3%	0%			
Storage Length (ft)		0	75		0	0		
Storage Lanes		0	0		0	0		
Taper Length (ft)			25		25			
Lane Util. Factor	1.00	1.00	0.97	1.00	1.00	1.00		
Ped Bike Factor	0.94		0.90					
Frt	0.923							
Flt Protected			0.950					
Satd. Flow (prot)	1434	0	2837	1592	0	0		
Flt Permitted			0.950					
Satd. Flow (perm)	1434	0	2565	1592	0	0		
Right Turn on Red		No				No		
Satd. Flow (RTOR)								
Link Speed (mph)	25			25	25			
Link Distance (ft)	391			120	794			
Travel Time (s)	30.0			10.7	21.7			
Confl. Peds. (#/hr)		57	57					
Peak Hour Factor	0.81	0.81	0.87	0.87	0.90	0.90		
Heavy Vehicles (%)	2%	2%	9%	9%	2%	2%		
Adj. Flow (vph)	148	199	701	155	0	0		
Shared Lane Traffic (%)								
Lane Group Flow (vph)	347	0	701	155	0	0		
Turn Type	NA		Prot	NA				
Protected Phases	2		1 4	6			1	4
Permitted Phases								
Detector Phase	2		1 4	6				
Switch Phase								
Minimum Initial (s)	10.0			10.0			7.0	7.0
Minimum Split (s)	17.0			15.0			13.0	20.0
Total Split (s)	25.0			40.0			15.0	20.0
Total Split (%)	41.7%			66.7%			25%	33%
Maximum Green (s)	19.9			35.0			9.9	16.0
Yellow Time (s)	3.0			3.3			3.0	3.0
All-Red Time (s)	2.1			1.7			2.1	1.0
Lost Time Adjust (s)	-0.1			0.0				
Total Lost Time (s)	5.0			5.0				
Lead/Lag	Lag						Lead	
Lead-Lag Optimize?								
Vehicle Extension (s)	1.0			1.0			4.0	0.2
Recall Mode	None			C-Max			C-Max	None
Walk Time (s)	7.0							7.0
Flash Dont Walk (s)	4.0							9.0
Pedestrian Calls (#/hr)	0							0
Act Effect Green (s)	20.0		30.0	38.6				

Lanes, Volumes, Timings
 15: NC 86 (Pittsboro St) & W. Cameron Avenue

09/01/2020



Lane Group	EBT	EBR	WBL	WBT	NBL	NBR	Ø1	Ø4
Actuated g/C Ratio	0.33		0.50	0.64				
v/c Ratio	0.73		0.49	0.15				
Control Delay	28.7		14.4	6.1				
Queue Delay	0.0		0.0	0.0				
Total Delay	28.7		14.4	6.1				
LOS	C		B	A				
Approach Delay	28.7			12.9				
Approach LOS	C			B				
Queue Length 50th (ft)	108		194	32				
Queue Length 95th (ft)	167		186	m83				
Internal Link Dist (ft)	311			40	714			
Turn Bay Length (ft)			75					
Base Capacity (vph)	478		1370	1025				
Starvation Cap Reductn	0		0	0				
Spillback Cap Reductn	0		0	0				
Storage Cap Reductn	0		0	0				
Reduced v/c Ratio	0.73		0.51	0.15				

Intersection Summary

Area Type: CBD
 Cycle Length: 60
 Actuated Cycle Length: 60
 Offset: 23 (38%), Referenced to phase 1:WBL and 6:WBT, Start of Green
 Natural Cycle: 60
 Control Type: Actuated-Coordinated
 Maximum v/c Ratio: 0.73
 Intersection Signal Delay: 17.5 Intersection LOS: B
 Intersection Capacity Utilization 48.1% ICU Level of Service A
 Analysis Period (min) 15
 m Volume for 95th percentile queue is metered by upstream signal.

Splits and Phases: 15: NC 86 (Pittsboro St) & W. Cameron Avenue

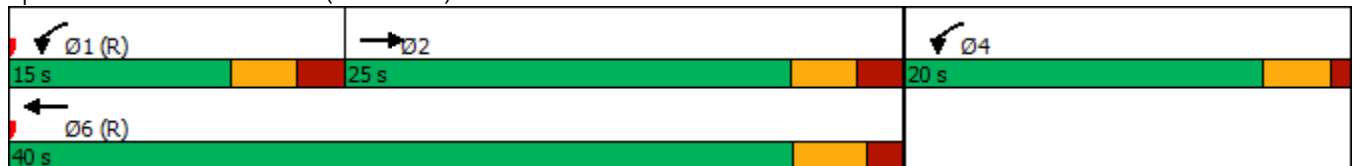

Lanes, Volumes, Timings

16: NC 86 (S. Columbia St) & W. Cameron Avenue/E. Cameron Avenue

09/01/2020



Lane Group	EBL	EBT	EBR	WBL	WBT	WBR	NBL	NBT	NBR	SBL	SBT	SBR
Lane Configurations												
Traffic Volume (vph)	18	92	0	0	96	20	99	417	43	67	0	546
Future Volume (vph)	18	92	0	0	96	20	99	417	43	67	0	546
Ideal Flow (vphpl)	1900	1900	1900	1900	1900	1900	1900	1900	1900	1900	1900	1900
Lane Width (ft)	11	12	12	12	12	12	10	10	10	11	11	12
Grade (%)		1%			-1%			1%			2%	
Storage Length (ft)	100		0	0		0	0		0	310		0
Storage Lanes	1		0	0		0	1		0	1		2
Taper Length (ft)	25			25			25			25		
Lane Util. Factor	1.00	1.00	1.00	1.00	1.00	1.00	0.91	0.91	0.95	1.00	1.00	0.88
Ped Bike Factor	0.95				0.99		0.79	0.95		0.76		0.77
Frt					0.977			0.986				0.850
Flt Protected	0.950						0.950	0.999		0.950		
Satd. Flow (prot)	1532	1668	0	0	1565	0	1248	2466	0	1413	0	2302
Flt Permitted	0.517						0.950	0.999		0.950		
Satd. Flow (perm)	796	1668	0	0	1565	0	982	2454	0	1078	0	1776
Right Turn on Red			No			No			No			No
Satd. Flow (RTOR)												
Link Speed (mph)		25			25			25			25	
Link Distance (ft)		273			989			826			981	
Travel Time (s)		10.7			57.6			22.5			26.8	
Confl. Peds. (#/hr)	39		102	102		39	71		107	107		71
Peak Hour Factor	0.79	0.79	0.79	0.83	0.83	0.83	0.86	0.86	0.86	0.89	0.89	0.89
Heavy Vehicles (%)	2%	2%	2%	6%	6%	6%	10%	10%	10%	10%	10%	10%
Adj. Flow (vph)	23	116	0	0	116	24	115	485	50	75	0	613
Shared Lane Traffic (%)							10%					
Lane Group Flow (vph)	23	116	0	0	140	0	103	547	0	75	0	613
Turn Type	Perm	NA			NA		Split	NA		Prot		Prot
Protected Phases		4			8		2	2		1		1
Permitted Phases	4									1		1
Detector Phase	4	4			8		2	2		1		1
Switch Phase												
Minimum Initial (s)	10.0	10.0			10.0		7.0	7.0		7.0		7.0
Minimum Split (s)	24.0	24.0			31.0		18.0	18.0		26.0		26.0
Total Split (s)	34.0	34.0			34.0		22.0	22.0		36.0		36.0
Total Split (%)	28.3%	28.3%			28.3%		18.3%	18.3%		30.0%		30.0%
Maximum Green (s)	27.8	27.8			27.8		16.1	16.1		30.4		30.4
Yellow Time (s)	3.2	3.2			3.2		3.1	3.1		3.0		3.0
All-Red Time (s)	3.0	3.0			3.0		2.8	2.8		2.6		2.6
Lost Time Adjust (s)	-1.2	-1.2			-1.2		-0.9	-0.9		-0.6		-0.6
Total Lost Time (s)	5.0	5.0			5.0		5.0	5.0		5.0		5.0
Lead/Lag							Lag	Lag		Lead		Lead
Lead-Lag Optimize?							Yes	Yes		Yes		Yes
Vehicle Extension (s)	2.0	2.0			2.0		4.0	4.0		4.0		4.0
Recall Mode	None	None			None		C-Max	C-Max		None		None
Walk Time (s)	7.0	7.0			7.0		7.0	7.0		7.0		7.0
Flash Dont Walk (s)	10.0	10.0			17.0		5.0	5.0		13.0		13.0
Pedestrian Calls (#/hr)	0	0			0		0	0		0		0
Act Effct Green (s)	16.5	16.5			16.5		45.7	45.7		42.8		42.8

Lanes, Volumes, Timings

16: NC 86 (S. Columbia St) & W. Cameron Avenue/E. Cameron Avenue

09/01/2020

Lane Group	Ø9
Lane Configurations	
Traffic Volume (vph)	
Future Volume (vph)	
Ideal Flow (vphpl)	
Lane Width (ft)	
Grade (%)	
Storage Length (ft)	
Storage Lanes	
Taper Length (ft)	
Lane Util. Factor	
Ped Bike Factor	
Frt	
Flt Protected	
Satd. Flow (prot)	
Flt Permitted	
Satd. Flow (perm)	
Right Turn on Red	
Satd. Flow (RTOR)	
Link Speed (mph)	
Link Distance (ft)	
Travel Time (s)	
Confl. Peds. (#/hr)	
Peak Hour Factor	
Heavy Vehicles (%)	
Adj. Flow (vph)	
Shared Lane Traffic (%)	
Lane Group Flow (vph)	
Turn Type	
Protected Phases	9
Permitted Phases	
Detector Phase	
Switch Phase	
Minimum Initial (s)	7.0
Minimum Split (s)	28.0
Total Split (s)	28.0
Total Split (%)	23%
Maximum Green (s)	24.0
Yellow Time (s)	3.0
All-Red Time (s)	1.0
Lost Time Adjust (s)	
Total Lost Time (s)	
Lead/Lag	
Lead-Lag Optimize?	
Vehicle Extension (s)	0.2
Recall Mode	None
Walk Time (s)	7.0
Flash Dont Walk (s)	17.0
Pedestrian Calls (#/hr)	0
Act Effect Green (s)	

Lanes, Volumes, Timings

16: NC 86 (S. Columbia St) & W. Cameron Avenue/E. Cameron Avenue

09/01/2020



Lane Group	EBL	EBT	EBR	WBL	WBT	WBR	NBL	NBT	NBR	SBL	SBT	SBR
Actuated g/C Ratio	0.14	0.14			0.14		0.38	0.38		0.36		0.36
v/c Ratio	0.21	0.51			0.65		0.22	0.58		0.15		0.75
Control Delay	36.3	41.0			62.5		28.5	33.9		7.0		16.6
Queue Delay	0.0	0.0			0.0		0.0	0.0		0.0		0.0
Total Delay	36.3	41.0			62.5		28.5	33.9		7.0		16.6
LOS	D	D			E		C	C		A		B
Approach Delay		40.2			62.5			33.0				15.5
Approach LOS		D			E			C				B
Queue Length 50th (ft)	13	82			104		58	181		5		88
Queue Length 95th (ft)	m17	m108			150		112	257		m16		303
Internal Link Dist (ft)		193			909			746				901
Turn Bay Length (ft)	100									310		
Base Capacity (vph)	192	403			378		475	938		503		820
Starvation Cap Reductn	0	0			0		0	0		0		0
Spillback Cap Reductn	0	0			0		0	0		0		0
Storage Cap Reductn	0	0			0		0	0		0		0
Reduced v/c Ratio	0.12	0.29			0.37		0.22	0.58		0.15		0.75

Intersection Summary

Area Type:	CBD
Cycle Length:	120
Actuated Cycle Length:	120
Offset:	39 (33%), Referenced to phase 2:NBTL, Start of Green
Natural Cycle:	135
Control Type:	Actuated-Coordinated
Maximum v/c Ratio:	0.75
Intersection Signal Delay:	28.7
Intersection LOS:	C
Intersection Capacity Utilization:	69.0%
ICU Level of Service:	C
Analysis Period (min):	15
m Volume for 95th percentile queue is metered by upstream signal.	

Splits and Phases: 16: NC 86 (S. Columbia St) & W. Cameron Avenue/E. Cameron Avenue

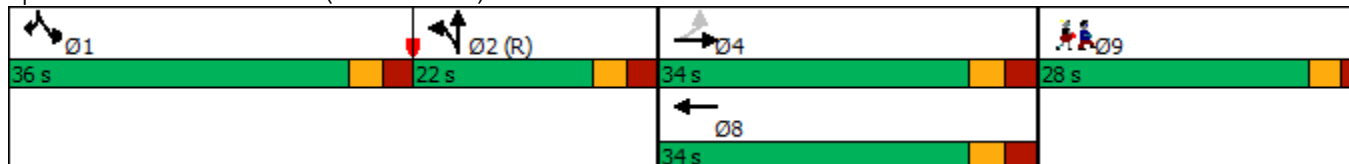

Lanes, Volumes, Timings

16: NC 86 (S. Columbia St) & W. Cameron Avenue/E. Cameron Avenue

09/01/2020

Lane Group	Ø9
Actuated g/C Ratio	
v/c Ratio	
Control Delay	
Queue Delay	
Total Delay	
LOS	
Approach Delay	
Approach LOS	
Queue Length 50th (ft)	
Queue Length 95th (ft)	
Internal Link Dist (ft)	
Turn Bay Length (ft)	
Base Capacity (vph)	
Starvation Cap Reductn	
Spillback Cap Reductn	
Storage Cap Reductn	
Reduced v/c Ratio	
Intersection Summary	

Lanes, Volumes, Timings

17: Raleigh Street & E. Cameron Avenue/Country Club Road

09/01/2020



Lane Group	EBL	EBT	EBR	WBL	WBT	WBR	NBL	NBT	NBR	SBL	SBT	SBR
Lane Configurations		↕		↖	↗		↖	↗		↖	↗	
Traffic Volume (vph)	23	44	32	28	143	224	24	45	17	303	149	48
Future Volume (vph)	23	44	32	28	143	224	24	45	17	303	149	48
Ideal Flow (vphpl)	1900	1900	1900	1900	1900	1900	1900	1900	1900	1900	1900	1900
Grade (%)		-3%			3%			-2%				1%
Storage Length (ft)	0		0	150		0	125		0	75		0
Storage Lanes	0		0	1		0	1		0	1		0
Taper Length (ft)	25			25			25			25		
Lane Util. Factor	1.00	1.00	1.00	1.00	1.00	1.00	1.00	1.00	1.00	1.00	1.00	1.00
Ped Bike Factor		0.98		0.98	0.98		0.91	0.96		0.89	0.95	
Frt		0.956			0.908			0.958			0.964	
Flt Protected		0.989		0.950			0.950			0.950		
Satd. Flow (prot)	0	1493	0	1569	1468	0	1492	1446	0	1569	1511	0
Flt Permitted		0.834		0.574			0.626			0.459		
Satd. Flow (perm)	0	1257	0	934	1468	0	894	1446	0	677	1511	0
Right Turn on Red			No			No			No			No
Satd. Flow (RTOR)												
Link Speed (mph)		25			25			25				25
Link Distance (ft)		598			651			409				995
Travel Time (s)		16.3			17.8			11.2				27.1
Confl. Peds. (#/hr)	3		6	6		3	31		25	25		31
Peak Hour Factor	0.71	0.71	0.71	0.84	0.84	0.84	0.79	0.79	0.79	0.94	0.94	0.94
Heavy Vehicles (%)	8%	8%	8%	2%	2%	2%	10%	10%	10%	3%	3%	3%
Adj. Flow (vph)	32	62	45	33	170	267	30	57	22	322	159	51
Shared Lane Traffic (%)												
Lane Group Flow (vph)	0	139	0	33	437	0	30	79	0	322	210	0
Turn Type	Perm	NA		pm+pt	NA		pm+pt	NA		pm+pt	NA	
Protected Phases		2		1	6		3	8		7	4	
Permitted Phases	2			6			8			4		
Detector Phase	2	2		1	6		3	8		7	4	
Switch Phase												
Minimum Initial (s)	10.0	10.0		7.0	10.0		7.0	7.0		7.0	7.0	
Minimum Split (s)	18.0	18.0		13.0	19.0		13.0	19.0		12.0	16.0	
Total Split (s)	50.0	50.0		20.0	70.0		20.0	35.0		20.0	35.0	
Total Split (%)	40.0%	40.0%		16.0%	56.0%		16.0%	28.0%		16.0%	28.0%	
Maximum Green (s)	43.9	43.9		14.4	64.4		14.7	29.7		15.1	29.9	
Yellow Time (s)	3.3	3.3		3.0	3.1		3.0	3.1		3.0	3.1	
All-Red Time (s)	2.8	2.8		2.6	2.5		2.3	2.2		1.9	2.0	
Lost Time Adjust (s)		-1.1		-0.6	-0.6		-0.3	-0.3		0.1	-0.1	
Total Lost Time (s)		5.0		5.0	5.0		5.0	5.0		5.0	5.0	
Lead/Lag	Lag	Lag		Lead			Lead	Lag		Lead	Lag	
Lead-Lag Optimize?	Yes	Yes		Yes			Yes	Yes		Yes	Yes	
Vehicle Extension (s)	2.0	2.0		2.0	2.0		2.0	2.0		2.0	2.0	
Recall Mode	None	None		None	None		None	None		None	None	
Walk Time (s)	4.0	4.0			4.0			4.0			4.0	
Flash Dont Walk (s)	7.0	7.0			9.0			9.0			6.0	
Pedestrian Calls (#/hr)	0	0			0			0			0	
Act Effect Green (s)		20.6		24.7	24.7		15.5	10.2		25.6	21.7	
Actuated g/C Ratio		0.33		0.40	0.40		0.25	0.17		0.42	0.35	

Lanes, Volumes, Timings

17: Raleigh Street & E. Cameron Avenue/Country Club Road

09/01/2020



Lane Group	EBL	EBT	EBR	WBL	WBT	WBR	NBL	NBT	NBR	SBL	SBT	SBR
v/c Ratio		0.33		0.07	0.74		0.10	0.33		0.65	0.39	
Control Delay		22.0		12.5	25.4		15.1	32.4		22.8	22.5	
Queue Delay		0.0		0.0	0.0		0.0	0.0		0.0	0.0	
Total Delay		22.0		12.5	25.4		15.1	32.4		22.8	22.5	
LOS		C		B	C		B	C		C	C	
Approach Delay		22.0			24.5			27.6			22.7	
Approach LOS		C			C			C			C	
Queue Length 50th (ft)		35		8	141		6	28		80	48	
Queue Length 95th (ft)		80		23	243		24	70		#235	170	
Internal Link Dist (ft)		518			571			329			915	
Turn Bay Length (ft)				150			125			75		
Base Capacity (vph)		923		570	1368		516	797		552	833	
Starvation Cap Reductn		0		0	0		0	0		0	0	
Spillback Cap Reductn		0		0	0		0	0		0	0	
Storage Cap Reductn		0		0	0		0	0		0	0	
Reduced v/c Ratio		0.15		0.06	0.32		0.06	0.10		0.58	0.25	

Intersection Summary

Area Type: CBD
 Cycle Length: 125
 Actuated Cycle Length: 61.6
 Natural Cycle: 65
 Control Type: Actuated-Uncoordinated
 Maximum v/c Ratio: 0.74
 Intersection Signal Delay: 23.7
 Intersection LOS: C
 Intersection Capacity Utilization 61.9%
 ICU Level of Service B
 Analysis Period (min) 15
 # 95th percentile volume exceeds capacity, queue may be longer.
 Queue shown is maximum after two cycles.

Splits and Phases: 17: Raleigh Street & E. Cameron Avenue/Country Club Road

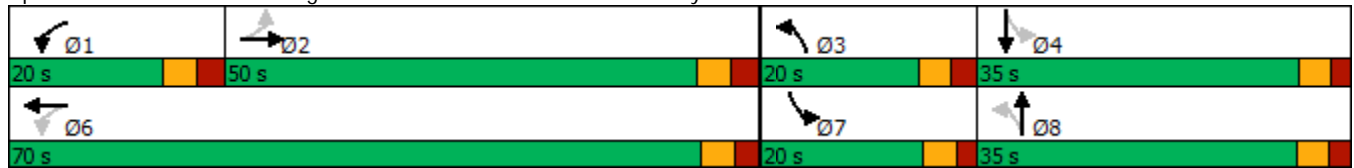

Lanes, Volumes, Timings
1: Church Street & W. Rosemary Street

09/01/2020



Lane Group	EBL	EBT	EBR	WBL	WBT	WBR	NBL	NBT	NBR	SBL	SBT	SBR
Lane Configurations		↕			↕			↕			↕	
Traffic Volume (vph)	6	331	29	46	361	24	23	42	61	14	33	10
Future Volume (vph)	6	331	29	46	361	24	23	42	61	14	33	10
Ideal Flow (vphpl)	1900	1900	1900	1900	1900	1900	1900	1900	1900	1900	1900	1900
Lane Width (ft)	12	14	12	12	14	12	12	12	12	12	12	12
Grade (%)		1%			-1%			0%			0%	
Lane Util. Factor	1.00	1.00	1.00	1.00	1.00	1.00	1.00	1.00	1.00	1.00	1.00	1.00
Ped Bike Factor		0.99			0.99			0.92			0.95	
Frt		0.989			0.992			0.935			0.976	
Flt Protected		0.999			0.995			0.991			0.988	
Satd. Flow (prot)	0	1710	0	0	1748	0	0	1472	0	0	1562	0
Flt Permitted		0.994			0.931			0.924			0.917	
Satd. Flow (perm)	0	1700	0	0	1629	0	0	1334	0	0	1425	0
Right Turn on Red			No			No			No			No
Satd. Flow (RTOR)												
Link Speed (mph)		20			20			25			25	
Link Distance (ft)		964			757			379			430	
Travel Time (s)		32.9			25.8			10.3			11.7	
Confl. Peds. (#/hr)	22		24	24		22	75		39	39		75
Peak Hour Factor	0.88	0.88	0.88	0.93	0.93	0.93	0.92	0.92	0.92	0.64	0.64	0.64
Heavy Vehicles (%)	4%	4%	4%	3%	3%	3%	2%	2%	2%	2%	2%	2%
Adj. Flow (vph)	7	376	33	49	388	26	25	46	66	22	52	16
Shared Lane Traffic (%)												
Lane Group Flow (vph)	0	416	0	0	463	0	0	137	0	0	90	0
Turn Type	Perm	NA		Perm	NA		Perm	NA		Perm	NA	
Protected Phases		2			6			8			4	
Permitted Phases	2			6			8			4		
Detector Phase	2	2		6	6		8	8		4	4	
Switch Phase												
Minimum Initial (s)	10.0	10.0		10.0	10.0		7.0	7.0		7.0	7.0	
Minimum Split (s)	19.0	19.0		20.0	20.0		19.0	19.0		19.0	19.0	
Total Split (s)	43.0	43.0		43.0	43.0		22.0	22.0		22.0	22.0	
Total Split (%)	66.2%	66.2%		66.2%	66.2%		33.8%	33.8%		33.8%	33.8%	
Maximum Green (s)	38.5	38.5		38.4	38.4		17.1	17.1		17.1	17.1	
Yellow Time (s)	3.1	3.1		3.1	3.1		3.2	3.2		3.2	3.2	
All-Red Time (s)	1.4	1.4		1.5	1.5		1.7	1.7		1.7	1.7	
Lost Time Adjust (s)		0.5			0.4			0.1			0.1	
Total Lost Time (s)		5.0			5.0			5.0			5.0	
Lead/Lag												
Lead-Lag Optimize?												
Vehicle Extension (s)	3.0	3.0		3.0	3.0		3.0	3.0		3.0	3.0	
Recall Mode	C-Max	C-Max		C-Max	C-Max		None	None		None	None	
Walk Time (s)	4.0	4.0		4.0	4.0		4.0	4.0		4.0	4.0	
Flash Dont Walk (s)	5.0	5.0		6.0	6.0		10.0	10.0		10.0	10.0	
Pedestrian Calls (#/hr)	0	0		0	0		0	0		0	0	
Act Effct Green (s)		46.7			46.7			11.7			11.7	
Actuated g/C Ratio		0.72			0.72			0.18			0.18	
v/c Ratio		0.34			0.40			0.57			0.35	
Control Delay		6.3			2.6			32.5			25.8	

Lanes, Volumes, Timings
 1: Church Street & W. Rosemary Street

09/01/2020



Lane Group	EBL	EBT	EBR	WBL	WBT	WBR	NBL	NBT	NBR	SBL	SBT	SBR
Queue Delay		0.0			0.0			0.0			0.0	
Total Delay		6.3			2.6			32.5			25.8	
LOS		A			A			C			C	
Approach Delay		6.3			2.6			32.5			25.8	
Approach LOS		A			A			C			C	
Queue Length 50th (ft)		60			23			52			32	
Queue Length 95th (ft)		129			46			66			43	
Internal Link Dist (ft)		884			677			299			350	
Turn Bay Length (ft)												
Base Capacity (vph)		1220			1169			348			372	
Starvation Cap Reductn		0			0			0			0	
Spillback Cap Reductn		0			0			0			0	
Storage Cap Reductn		0			0			0			0	
Reduced v/c Ratio		0.34			0.40			0.39			0.24	

Intersection Summary

Area Type:	CBD
Cycle Length:	65
Actuated Cycle Length:	65
Offset:	23 (35%), Referenced to phase 2:EBTL and 6:WBTL, Start of Green
Natural Cycle:	40
Control Type:	Actuated-Coordinated
Maximum v/c Ratio:	0.57
Intersection Signal Delay:	9.6
Intersection LOS:	A
Intersection Capacity Utilization	71.6%
ICU Level of Service	C
Analysis Period (min)	15

Splits and Phases: 1: Church Street & W. Rosemary Street



Lanes, Volumes, Timings

2: NC 86 (N. Columbia St) & W. Rosemary Street/E. Rosemary Street

09/01/2020



Lane Group	EBL	EBT	EBR	WBL	WBT	WBR	NBL	NBT	NBR	SBL	SBT	SBR
Lane Configurations												
Traffic Volume (vph)	157	212	48	72	224	49	44	318	141	61	360	180
Future Volume (vph)	157	212	48	72	224	49	44	318	141	61	360	180
Ideal Flow (vphpl)	1900	1900	1900	1900	1900	1900	1900	1900	1900	1900	1900	1900
Lane Width (ft)	9	12	13	12	12	12	9	10	12	12	9	11
Grade (%)		1%			1%			-2%			8%	
Storage Length (ft)	100		0	150		0	75		0	150		400
Storage Lanes	1		0	1		0	1		0	1		1
Taper Length (ft)	25			25			25			25		
Lane Util. Factor	1.00	1.00	1.00	1.00	1.00	1.00	1.00	0.95	0.95	1.00	0.95	1.00
Ped Bike Factor	0.97	0.99		0.96	0.98		0.86	0.85		0.80		0.66
Frt		0.972			0.973			0.954				0.850
Flt Protected	0.950			0.950			0.950			0.950		
Satd. Flow (prot)	1426	1599	0	1585	1597	0	1355	2265	0	1485	2673	1285
Flt Permitted	0.254			0.579			0.442			0.411		
Satd. Flow (perm)	369	1599	0	925	1597	0	539	2265	0	517	2673	850
Right Turn on Red			No			No			No			No
Satd. Flow (RTOR)												
Link Speed (mph)		20			20			25			25	
Link Distance (ft)		757			456			353			476	
Travel Time (s)		25.8			15.5			9.6			13.0	
Confl. Peds. (#/hr)	53		41	41		53	80		129	129		80
Peak Hour Factor	0.88	0.88	0.88	0.85	0.85	0.85	0.98	0.98	0.98	0.86	0.86	0.86
Heavy Vehicles (%)	2%	2%	2%	2%	2%	2%	9%	9%	9%	5%	5%	5%
Adj. Flow (vph)	178	241	55	85	264	58	45	324	144	71	419	209
Shared Lane Traffic (%)												
Lane Group Flow (vph)	178	296	0	85	322	0	45	468	0	71	419	209
Turn Type	pm+pt	NA		Perm	NA		pm+pt	NA		pm+pt	NA	pm+ov
Protected Phases	7	4			8		5	2		1	6	7
Permitted Phases	4			8			2			6		6
Detector Phase	7	4		8	8		5	2		1	6	7
Switch Phase												
Minimum Initial (s)	7.0	7.0		7.0	7.0		7.0	10.0		7.0	10.0	7.0
Minimum Split (s)	13.0	31.0		32.0	32.0		13.0	23.0		13.0	22.0	13.0
Total Split (s)	43.0	63.0		20.0	20.0		15.0	52.0		15.0	52.0	43.0
Total Split (%)	33.1%	48.5%		15.4%	15.4%		11.5%	40.0%		11.5%	40.0%	33.1%
Maximum Green (s)	37.2	57.0		14.0	14.0		9.2	46.2		9.9	46.2	37.2
Yellow Time (s)	3.0	3.2		3.2	3.2		3.0	3.3		3.0	3.3	3.0
All-Red Time (s)	2.8	2.8		2.8	2.8		2.8	2.5		2.1	2.5	2.8
Lost Time Adjust (s)	-0.8	-1.0		-1.0	-1.0		0.0	-0.8		-0.1	-0.8	-0.8
Total Lost Time (s)	5.0	5.0		5.0	5.0		5.8	5.0		5.0	5.0	5.0
Lead/Lag	Lead			Lag	Lag		Lead	Lag		Lead	Lag	Lead
Lead-Lag Optimize?												
Vehicle Extension (s)	1.0	1.0		1.0	1.0		1.0	3.0		1.0	3.0	1.0
Recall Mode	None	None		None	None		None	C-Max		None	C-Max	None
Walk Time (s)		7.0		7.0	7.0			7.0			7.0	
Flash Dont Walk (s)		18.0		19.0	19.0			10.0			9.0	
Pedestrian Calls (#/hr)		0		0	0			0			0	
Act Effect Green (s)	58.0	58.0		33.4	33.4		56.6	51.5		58.0	51.5	71.1

Lanes, Volumes, Timings

2: NC 86 (N. Columbia St) & W. Rosemary Street/E. Rosemary Street

09/01/2020



Lane Group	EBL	EBT	EBR	WBL	WBT	WBR	NBL	NBT	NBR	SBL	SBT	SBR
Actuated g/C Ratio	0.45	0.45		0.26	0.26		0.44	0.40		0.45	0.40	0.55
v/c Ratio	0.55	0.42		0.36	0.79		0.16	0.52		0.25	0.40	0.39
Control Delay	30.1	27.6		45.0	57.8		16.6	20.4		18.8	25.2	12.8
Queue Delay	0.0	0.0		0.0	0.0		0.0	0.5		0.0	0.0	0.0
Total Delay	30.1	27.6		45.0	57.8		16.6	20.9		18.8	25.2	12.8
LOS	C	C		D	E		B	C		B	C	B
Approach Delay		28.6			55.1			20.5			20.8	
Approach LOS		C			E			C			C	
Queue Length 50th (ft)	92	192		52	236		11	62		26	117	43
Queue Length 95th (ft)	123	245		112	#426		m26	137		42	106	52
Internal Link Dist (ft)		677			376			273			396	
Turn Bay Length (ft)	100			150			75			150		400
Base Capacity (vph)	473	713		237	409		298	897		310	1058	712
Starvation Cap Reductn	0	0		0	0		0	149		0	0	0
Spillback Cap Reductn	0	0		0	0		0	0		0	7	0
Storage Cap Reductn	0	0		0	0		0	0		0	0	0
Reduced v/c Ratio	0.38	0.42		0.36	0.79		0.15	0.63		0.23	0.40	0.29

Intersection Summary

Area Type: CBD
 Cycle Length: 130
 Actuated Cycle Length: 130
 Offset: 55 (42%), Referenced to phase 2:NBTL and 6:SBTL, Start of Green
 Natural Cycle: 85
 Control Type: Actuated-Coordinated
 Maximum v/c Ratio: 0.79
 Intersection Signal Delay: 29.2 Intersection LOS: C
 Intersection Capacity Utilization 69.9% ICU Level of Service C
 Analysis Period (min) 15
 # 95th percentile volume exceeds capacity, queue may be longer.
 Queue shown is maximum after two cycles.
 m Volume for 95th percentile queue is metered by upstream signal.

Splits and Phases: 2: NC 86 (N. Columbia St) & W. Rosemary Street/E. Rosemary Street

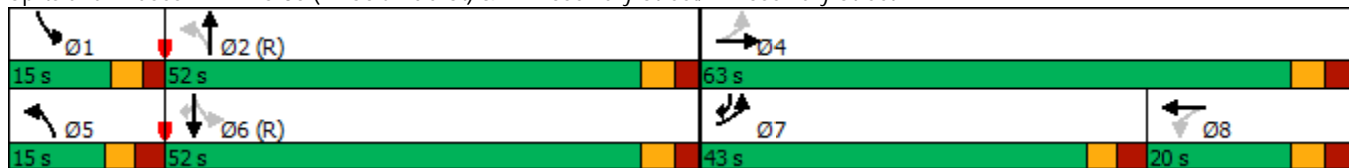

Lanes, Volumes, Timings
6: Henderson Street & E. Rosemary Street

09/01/2020



Lane Group	EBL	EBT	EBR	WBL	WBT	WBR	NBL	NBT	NBR	SBL	SBT	SBR
Lane Configurations												
Traffic Volume (vph)	15	201	130	15	217	31	64	30	11	9	38	13
Future Volume (vph)	15	201	130	15	217	31	64	30	11	9	38	13
Ideal Flow (vphpl)	1900	1900	1900	1900	1900	1900	1900	1900	1900	1900	1900	1900
Grade (%)		0%			0%			0%				3%
Storage Length (ft)	85		0	0		0	0		0	0		0
Storage Lanes	1		0	0		0	0		0	0		0
Taper Length (ft)	25			25			25			25		
Lane Util. Factor	1.00	1.00	1.00	1.00	1.00	1.00	1.00	1.00	1.00	1.00	1.00	1.00
Ped Bike Factor	0.96	0.97			0.99			0.84				0.93
Frt		0.941			0.984			0.986				0.971
Flt Protected	0.950				0.997			0.970				0.992
Satd. Flow (prot)	1593	1531	0	0	1629	0	0	1581	0	0	1497	0
Flt Permitted	0.630				0.977			0.772				0.941
Satd. Flow (perm)	1018	1531	0	0	1593	0	0	1074	0	0	1400	0
Right Turn on Red			No			No			No			No
Satd. Flow (RTOR)												
Link Speed (mph)		20			20			20				20
Link Distance (ft)		232			1195			366				450
Travel Time (s)		7.9			40.7			12.5				15.3
Confl. Peds. (#/hr)	21		19	19		21	106		47	47		106
Peak Hour Factor	0.96	0.96	0.96	0.95	0.95	0.95	0.68	0.68	0.68	0.85	0.85	0.85
Adj. Flow (vph)	16	209	135	16	228	33	94	44	16	11	45	15
Shared Lane Traffic (%)												
Lane Group Flow (vph)	16	344	0	0	277	0	0	154	0	0	71	0
Turn Type	Perm	NA		Perm	NA		Perm	NA		Perm	NA	
Protected Phases		2			2			4				4
Permitted Phases	2			2			4			4		
Detector Phase	2	2		2	2		4	4		4		4
Switch Phase												
Minimum Initial (s)	11.0	11.0		11.0	11.0		8.0	8.0		8.0		8.0
Minimum Split (s)	15.9	15.9		15.9	15.9		17.8	17.8		17.8		17.8
Total Split (s)	38.0	38.0		38.0	38.0		27.0	27.0		27.0		27.0
Total Split (%)	58.5%	58.5%		58.5%	58.5%		41.5%	41.5%		41.5%		41.5%
Maximum Green (s)	33.1	33.1		33.1	33.1		22.2	22.2		22.2		22.2
Yellow Time (s)	3.3	3.3		3.3	3.3		3.3	3.3		3.3		3.3
All-Red Time (s)	1.6	1.6		1.6	1.6		1.5	1.5		1.5		1.5
Lost Time Adjust (s)	0.1	0.1			0.1			0.2				0.2
Total Lost Time (s)	5.0	5.0			5.0			5.0				5.0
Lead/Lag												
Lead-Lag Optimize?												
Vehicle Extension (s)	2.0	2.0		2.0	2.0		2.0	2.0		2.0		2.0
Recall Mode	C-Max	C-Max		C-Max	C-Max		None	None		None		None
Walk Time (s)	4.0	4.0		4.0	4.0		4.0	4.0		4.0		4.0
Flash Dont Walk (s)	7.0	7.0		7.0	7.0		9.0	9.0		9.0		9.0
Pedestrian Calls (#/hr)	0	0		0	0		0	0		0		0
Act Effct Green (s)	45.0	45.0			45.0			13.6				13.6
Actuated g/C Ratio	0.69	0.69			0.69			0.21				0.21
v/c Ratio	0.02	0.32			0.25			0.69				0.24

Lanes, Volumes, Timings
 6: Henderson Street & E. Rosemary Street

09/01/2020



Lane Group	EBL	EBT	EBR	WBL	WBT	WBR	NBL	NBT	NBR	SBL	SBT	SBR
Control Delay	6.5	6.6			6.7			36.5			21.5	
Queue Delay	0.0	0.0			0.0			0.0			0.0	
Total Delay	6.5	6.6			6.7			36.5			21.5	
LOS	A	A			A			D			C	
Approach Delay		6.6			6.7			36.5			21.5	
Approach LOS		A			A			D			C	
Queue Length 50th (ft)	2	51			63			69			24	
Queue Length 95th (ft)	m9	128			119			68			45	
Internal Link Dist (ft)		152			1115			286			370	
Turn Bay Length (ft)	85											
Base Capacity (vph)	704	1060			1102			363			473	
Starvation Cap Reductn	0	0			0			0			0	
Spillback Cap Reductn	0	0			0			0			0	
Storage Cap Reductn	0	0			0			0			0	
Reduced v/c Ratio	0.02	0.32			0.25			0.42			0.15	

Intersection Summary

Area Type: CBD
 Cycle Length: 65
 Actuated Cycle Length: 65
 Offset: 63 (97%), Referenced to phase 2:EBWB, Start of Green
 Natural Cycle: 40
 Control Type: Actuated-Coordinated
 Maximum v/c Ratio: 0.69
 Intersection Signal Delay: 13.2
 Intersection LOS: B
 Intersection Capacity Utilization 50.7%
 ICU Level of Service A
 Analysis Period (min) 15
 m Volume for 95th percentile queue is metered by upstream signal.

Splits and Phases: 6: Henderson Street & E. Rosemary Street



Lanes, Volumes, Timings
7: Hillsborough Street & E. Rosemary Street

09/01/2020



Lane Group	EBL	EBT	EBR	WBL	WBT	WBR	NBL	NBT	NBR	SBL	SBT	SBR
Lane Configurations		↕			↕		↗	↘		↗	↘	
Traffic Volume (vph)	25	91	93	3	52	9	172	181	9	16	220	28
Future Volume (vph)	25	91	93	3	52	9	172	181	9	16	220	28
Ideal Flow (vphpl)	1900	1900	1900	1900	1900	1900	1900	1900	1900	1900	1900	1900
Storage Length (ft)	0		0	0		0	100		0	100		0
Storage Lanes	0		0	0		0	1		0	1		0
Taper Length (ft)	25			25			25			25		
Lane Util. Factor	1.00	1.00	1.00	1.00	1.00	1.00	1.00	1.00	1.00	1.00	1.00	1.00
Ped Bike Factor		0.95			0.98		0.93	1.00		0.99	0.98	
Frt		0.940			0.980			0.993			0.983	
Flt Protected		0.994			0.998		0.950			0.950		
Satd. Flow (prot)	0	1668	0	0	1792	0	1770	1847	0	1719	1743	0
Flt Permitted		0.955			0.982		0.481			0.623		
Satd. Flow (perm)	0	1586	0	0	1759	0	834	1847	0	1114	1743	0
Right Turn on Red			No			No			No			No
Satd. Flow (RTOR)												
Link Speed (mph)		20			20			25			25	
Link Distance (ft)		1195			527			363			726	
Travel Time (s)		40.7			18.0			9.9			19.8	
Confl. Peds. (#/hr)	35		35	35		35	50		5	5		50
Peak Hour Factor	0.93	0.93	0.93	0.78	0.78	0.78	0.88	0.88	0.88	0.91	0.91	0.91
Heavy Vehicles (%)	2%	2%	2%	2%	2%	2%	2%	2%	2%	5%	5%	5%
Adj. Flow (vph)	27	98	100	4	67	12	195	206	10	18	242	31
Shared Lane Traffic (%)												
Lane Group Flow (vph)	0	225	0	0	83	0	195	216	0	18	273	0
Turn Type	Perm	NA		Perm	NA		pm+pt	NA		Perm	NA	
Protected Phases		4			8		5	2			6	
Permitted Phases	4			8			2			6		
Detector Phase	4	4		8	8		5	2		6	6	
Switch Phase												
Minimum Initial (s)	7.0	7.0		7.0	7.0		7.0	10.0		10.0	10.0	
Minimum Split (s)	20.0	20.0		17.0	17.0		12.0	15.0		15.0	15.0	
Total Split (s)	24.0	24.0		24.0	24.0		13.0	41.0		28.0	28.0	
Total Split (%)	36.9%	36.9%		36.9%	36.9%		20.0%	63.1%		43.1%	43.1%	
Maximum Green (s)	19.1	19.1		19.0	19.0		8.2	36.2		23.2	23.2	
Yellow Time (s)	3.0	3.0		3.3	3.3		3.0	3.3		3.1	3.1	
All-Red Time (s)	1.9	1.9		1.7	1.7		1.8	1.5		1.7	1.7	
Lost Time Adjust (s)		0.1			0.0		0.2	0.2		0.2	0.2	
Total Lost Time (s)		5.0			5.0		5.0	5.0		5.0	5.0	
Lead/Lag							Lead			Lag	Lag	
Lead-Lag Optimize?												
Vehicle Extension (s)	2.0	2.0		2.0	2.0		2.0	2.0		2.0	2.0	
Recall Mode	None	None		None	None		None	C-Max		C-Max	C-Max	
Walk Time (s)	4.0	4.0		4.0	4.0			4.0		4.0	4.0	
Flash Dont Walk (s)	11.0	11.0		8.0	8.0			6.0		6.0	6.0	
Pedestrian Calls (#/hr)	0	0		0	0			0		0	0	
Act Effct Green (s)		13.3			13.3		41.7	41.7		29.2	29.2	
Actuated g/C Ratio		0.20			0.20		0.64	0.64		0.45	0.45	
v/c Ratio		0.69			0.23		0.30	0.18		0.04	0.35	

Lanes, Volumes, Timings
 7: Hillsborough Street & E. Rosemary Street

09/01/2020



Lane Group	EBL	EBT	EBR	WBL	WBT	WBR	NBL	NBT	NBR	SBL	SBT	SBR
Control Delay		32.7			21.4		6.4	5.6		13.0	14.9	
Queue Delay		0.0			0.0		0.0	0.0		0.0	0.0	
Total Delay		32.7			21.4		6.4	5.6		13.0	14.9	
LOS		C			C		A	A		B	B	
Approach Delay		32.7			21.4			5.9			14.7	
Approach LOS		C			C			A			B	
Queue Length 50th (ft)		86			28		52	58		4	66	
Queue Length 95th (ft)		114			46		65	73		17	142	
Internal Link Dist (ft)		1115			447			283			646	
Turn Bay Length (ft)							100			100		
Base Capacity (vph)		463			514		651	1184		500	783	
Starvation Cap Reductn		0			0		0	0		0	0	
Spillback Cap Reductn		0			0		0	0		0	0	
Storage Cap Reductn		0			0		0	0		0	0	
Reduced v/c Ratio		0.49			0.16		0.30	0.18		0.04	0.35	

Intersection Summary

Area Type:	Other
Cycle Length:	65
Actuated Cycle Length:	65
Offset:	19 (29%), Referenced to phase 2:NBTL and 6:SBTL, Start of Green
Natural Cycle:	50
Control Type:	Actuated-Coordinated
Maximum v/c Ratio:	0.69
Intersection Signal Delay:	15.7
Intersection LOS:	B
Intersection Capacity Utilization	55.6%
ICU Level of Service	B
Analysis Period (min)	15

Splits and Phases: 7: Hillsborough Street & E. Rosemary Street

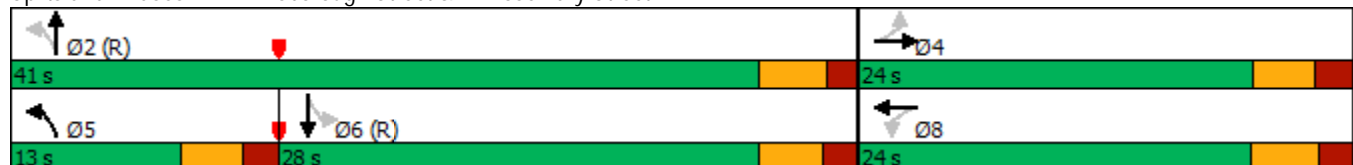

Lanes, Volumes, Timings

8: Carolina Square Driveway/Church Street & W. Franklin Street

09/01/2020



Lane Group	EBL	EBT	EBR	WBL	WBT	WBR	NBL	NBT	NBR	SBL	SBT	SBR
Lane Configurations												
Traffic Volume (vph)	56	367	26	32	336	69	10	10	22	23	23	60
Future Volume (vph)	56	367	26	32	336	69	10	10	22	23	23	60
Ideal Flow (vphpl)	1900	1900	1900	1900	1900	1900	1900	1900	1900	1900	1900	1900
Lane Width (ft)	10	10	16	10	10	10	12	12	12	12	12	12
Grade (%)		2%			-2%			-4%				-3%
Storage Length (ft)	150		0	200		0	0		100	0		0
Storage Lanes	1		0	1		0	0		1	0		0
Taper Length (ft)	25			25			25			25		
Lane Util. Factor	1.00	1.00	1.00	1.00	1.00	1.00	1.00	1.00	1.00	1.00	1.00	1.00
Ped Bike Factor	0.85	0.97		0.79	0.93			0.86	0.87		0.78	
Frt		0.990			0.974				0.850		0.923	
Flt Protected	0.950			0.950				0.976			0.989	
Satd. Flow (prot)	1443	1453	0	1472	1410	0	0	1669	1454	0	1198	0
Flt Permitted	0.475			0.470				0.827			0.928	
Satd. Flow (perm)	610	1453	0	573	1410	0	0	1221	1262	0	1098	0
Right Turn on Red			No			No			No			No
Satd. Flow (RTOR)												
Link Speed (mph)		20			20			20			25	
Link Distance (ft)		993			298			285			379	
Travel Time (s)		33.9			10.2			9.7			10.3	
Confl. Peds. (#/hr)	150		248	248		150	225		77	77		225
Peak Hour Factor	0.87	0.87	0.87	0.91	0.91	0.91	0.81	0.81	0.81	0.71	0.71	0.71
Heavy Vehicles (%)	4%	4%	4%	4%	4%	4%	2%	2%	2%	5%	5%	5%
Adj. Flow (vph)	64	422	30	35	369	76	12	12	27	32	32	85
Shared Lane Traffic (%)												
Lane Group Flow (vph)	64	452	0	35	445	0	0	24	27	0	149	0
Turn Type	Perm	NA		Perm	NA		Perm	NA	Perm	Perm	NA	
Protected Phases		2			6			8				4
Permitted Phases	2			6			8		8	4		
Detector Phase	2	2		6	6		8	8	8	4	4	
Switch Phase												
Minimum Initial (s)	10.0	10.0		10.0	10.0		7.0	7.0	7.0	7.0	7.0	
Minimum Split (s)	22.0	22.0		19.0	19.0		29.0	29.0	29.0	27.0	27.0	
Total Split (s)	36.0	36.0		36.0	36.0		29.0	29.0	29.0	29.0	29.0	
Total Split (%)	55.4%	55.4%		55.4%	55.4%		44.6%	44.6%	44.6%	44.6%	44.6%	
Maximum Green (s)	30.4	30.4		30.4	30.4		22.7	22.7	22.7	23.0	23.0	
Yellow Time (s)	3.3	3.3		3.3	3.3		3.1	3.1	3.1	3.4	3.4	
All-Red Time (s)	2.3	2.3		2.3	2.3		3.2	3.2	3.2	2.6	2.6	
Lost Time Adjust (s)	-0.6	-0.6		-0.6	-0.6		-1.3	-1.3	-1.3	-1.0	-1.0	
Total Lost Time (s)	5.0	5.0		5.0	5.0		5.0	5.0	5.0	5.0	5.0	
Lead/Lag												
Lead-Lag Optimize?												
Vehicle Extension (s)	3.0	3.0		3.0	3.0		2.0	2.0	2.0	2.0	2.0	
Recall Mode	C-Max	C-Max		C-Max	C-Max		None	None	None	None	None	
Walk Time (s)	7.0	7.0		7.0	7.0		7.0	7.0	7.0	7.0	7.0	
Flash Dont Walk (s)	9.0	9.0		6.0	6.0		15.0	15.0	15.0	14.0	14.0	
Pedestrian Calls (#/hr)	0	0		0	0		0	0	0	0	0	
Act Effect Green (s)	44.4	44.4		44.4	44.4		14.3	14.3	14.3	14.2	14.2	

Lanes, Volumes, Timings

8: Carolina Square Driveway/Church Street & W. Franklin Street

09/01/2020



Lane Group	EBL	EBT	EBR	WBL	WBT	WBR	NBL	NBT	NBR	SBL	SBT	SBR
Actuated g/C Ratio	0.68	0.68		0.68	0.68			0.22	0.22		0.22	
v/c Ratio	0.15	0.46		0.09	0.46			0.09	0.10		0.62	
Control Delay	8.0	9.5		8.9	11.6			18.3	18.5		32.3	
Queue Delay	0.0	0.0		0.0	0.0			0.0	0.0		0.0	
Total Delay	8.0	9.5		8.9	11.6			18.3	18.5		32.3	
LOS	A	A		A	B			B	B		C	
Approach Delay		9.3			11.4			18.4			32.3	
Approach LOS		A			B			B			C	
Queue Length 50th (ft)	9	82		3	46			8	9		63	
Queue Length 95th (ft)	32	186		m28	352			19	21		64	
Internal Link Dist (ft)		913			218			205			299	
Turn Bay Length (ft)	150			200					100			
Base Capacity (vph)	416	992		391	962			450	465		405	
Starvation Cap Reductn	0	0		0	0			0	0		0	
Spillback Cap Reductn	0	0		0	0			0	0		0	
Storage Cap Reductn	0	0		0	0			0	0		0	
Reduced v/c Ratio	0.15	0.46		0.09	0.46			0.05	0.06		0.37	

Intersection Summary

Area Type:	CBD
Cycle Length:	65
Actuated Cycle Length:	65
Offset:	2 (3%), Referenced to phase 2:EBTL and 6:WBTL, Start of Green
Natural Cycle:	60
Control Type:	Actuated-Coordinated
Maximum v/c Ratio:	0.62
Intersection Signal Delay:	13.4
Intersection LOS:	B
Intersection Capacity Utilization:	71.2%
ICU Level of Service:	C
Analysis Period (min):	15
m Volume for 95th percentile queue is metered by upstream signal.	

Splits and Phases: 8: Carolina Square Driveway/Church Street & W. Franklin Street



Lanes, Volumes, Timings

9: NC 86 (S. Columbia St)/NC 86 (N. Columbia St) & W. Franklin Street/E. Franklin Street 09/01/2020



Lane Group	EBL	EBT	EBR	WBL	WBT	WBR	NBL	NBT	NBR	SBL	SBT	SBR
Lane Configurations	↖	↗		↖	↗	↗	↖	↗		↖	↗	
Traffic Volume (vph)	108	301	46	83	311	88	62	317	91	51	330	92
Future Volume (vph)	108	301	46	83	311	88	62	317	91	51	330	92
Ideal Flow (vphpl)	1900	1900	1900	1900	1900	1900	1900	1900	1900	1900	1900	1900
Lane Width (ft)	9	12	13	10	10	13	9	10	10	9	9	11
Grade (%)		3%			1%			-2%			3%	
Storage Length (ft)	250		0	125		0	475		0	125		0
Storage Lanes	1		0	1		1	1		0	1		0
Taper Length (ft)	25			25			25			25		
Lane Util. Factor	1.00	0.95	0.95	1.00	1.00	1.00	1.00	0.95	0.95	1.00	0.95	0.95
Ped Bike Factor	0.80	0.96		0.82		0.67	0.83	0.92		0.81	0.92	
Frt		0.980				0.850		0.967			0.967	
Flt Protected	0.950			0.950			0.950			0.950		
Satd. Flow (prot)	1372	2854	0	1437	1512	1423	1342	2477	0	1346	2400	0
Flt Permitted	0.950			0.950			0.950			0.950		
Satd. Flow (perm)	1097	2854	0	1179	1512	947	1109	2477	0	1087	2400	0
Right Turn on Red			No			No			No			No
Satd. Flow (RTOR)												
Link Speed (mph)		20			20			25			25	
Link Distance (ft)		457			941			981			353	
Travel Time (s)		15.6			32.1			26.8			9.6	
Confl. Peds. (#/hr)	251		248	248		251	117		321	321		117
Peak Hour Factor	0.80	0.80	0.80	0.87	0.87	0.87	0.93	0.93	0.93	0.85	0.85	0.85
Heavy Vehicles (%)	5%	5%	5%	5%	5%	5%	10%	10%	10%	7%	7%	7%
Adj. Flow (vph)	135	376	58	95	357	101	67	341	98	60	388	108
Shared Lane Traffic (%)												
Lane Group Flow (vph)	135	434	0	95	357	101	67	439	0	60	496	0
Turn Type	Prot	NA		Prot	NA	pm+ov	Prot	NA		Prot	NA	
Protected Phases	5	2		1	6	7	3	8		7	4	
Permitted Phases						6						
Detector Phase	5	2		1	6	7	3	8		7	4	
Switch Phase												
Minimum Initial (s)	7.0	10.0		7.0	10.0	7.0	7.0	7.0		7.0	7.0	
Minimum Split (s)	15.0	28.2		15.0	28.2	15.0	15.0	28.0		15.0	28.1	
Total Split (s)	25.0	32.0		25.0	32.0	25.0	25.0	48.0		25.0	48.0	
Total Split (%)	19.2%	24.6%		19.2%	24.6%	19.2%	19.2%	36.9%		19.2%	36.9%	
Maximum Green (s)	19.6	25.8		19.1	25.8	19.1	19.1	42.1		19.1	42.3	
Yellow Time (s)	3.0	3.0		3.0	3.0	3.0	3.0	3.3		3.0	3.1	
All-Red Time (s)	2.4	3.2		2.9	3.2	2.9	2.9	2.6		2.9	2.6	
Lost Time Adjust (s)	-0.4	-1.2		-0.9	-1.2	-2.0	-0.9	-0.9		-0.9	-0.7	
Total Lost Time (s)	5.0	5.0		5.0	5.0	3.9	5.0	5.0		5.0	5.0	
Lead/Lag	Lead	Lag		Lead	Lag	Lead	Lead	Lag		Lead	Lag	
Lead-Lag Optimize?												
Vehicle Extension (s)	1.0	3.0		1.0	3.0	1.0	1.0	2.0		1.0	2.0	
Recall Mode	None	C-Max		None	C-Max	None	None	Ped		None	Ped	
Walk Time (s)		7.0			7.0			7.0			7.0	
Flash Dont Walk (s)		15.0			15.0			15.0			15.0	
Pedestrian Calls (#/hr)		0			0			0			0	
Act Effect Green (s)	16.6	53.6		13.1	50.1	63.0	11.3	32.6		10.7	34.6	

Lanes, Volumes, Timings

9: NC 86 (S. Columbia St)/NC 86 (N. Columbia St) & W. Franklin Street/E. Franklin Street 09/01/2020



Lane Group	EBL	EBT	EBR	WBL	WBT	WBR	NBL	NBT	NBR	SBL	SBT	SBR
Actuated g/C Ratio	0.13	0.41		0.10	0.39	0.48	0.09	0.25		0.08	0.27	
v/c Ratio	0.77	0.37		0.66	0.61	0.20	0.58	0.71		0.55	0.78	
Control Delay	75.2	33.6		82.5	42.1	15.9	100.2	28.2		88.8	33.4	
Queue Delay	0.0	0.0		0.0	0.0	0.0	0.0	0.0		0.0	0.1	
Total Delay	75.2	33.6		82.5	42.1	15.9	100.2	28.2		88.8	33.5	
LOS	E	C		F	D	B	F	C		F	C	
Approach Delay		43.5			44.3			37.7			39.4	
Approach LOS		D			D			D			D	
Queue Length 50th (ft)	108	133		73	252	31	58	71		53	101	
Queue Length 95th (ft)	144	215		136	#503	76	107	66		94	97	
Internal Link Dist (ft)		377			861			901			273	
Turn Bay Length (ft)	250			125			475			125		
Base Capacity (vph)	219	1177		221	582	604	206	819		207	793	
Starvation Cap Reductn	0	0		0	0	0	0	0		0	16	
Spillback Cap Reductn	0	0		0	0	0	0	0		0	0	
Storage Cap Reductn	0	0		0	0	0	0	0		0	0	
Reduced v/c Ratio	0.62	0.37		0.43	0.61	0.17	0.33	0.54		0.29	0.64	

Intersection Summary

Area Type: CBD
 Cycle Length: 130
 Actuated Cycle Length: 130
 Offset: 0 (0%), Referenced to phase 2:EBT and 6:WBT, Start of Green
 Natural Cycle: 90
 Control Type: Actuated-Coordinated
 Maximum v/c Ratio: 0.78
 Intersection Signal Delay: 41.3
 Intersection LOS: D
 Intersection Capacity Utilization 65.8%
 ICU Level of Service C
 Analysis Period (min) 15

95th percentile volume exceeds capacity, queue may be longer.
 Queue shown is maximum after two cycles.

Splits and Phases: 9: NC 86 (S. Columbia St)/NC 86 (N. Columbia St) & W. Franklin Street/E. Franklin Street

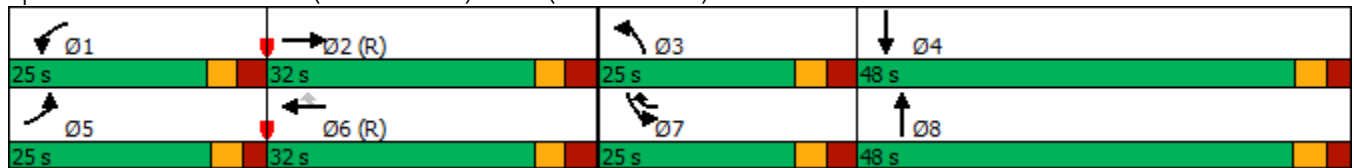

Lanes, Volumes, Timings
10: E. Franklin Street & Henderson Street

09/01/2020



Lane Group	EBL	EBT	WBT	WBR	SBL	SBR
Lane Configurations		↑↑	↑↓		↑↓	
Traffic Volume (vph)	47	381	419	63	104	81
Future Volume (vph)	47	381	419	63	104	81
Ideal Flow (vphpl)	1900	1900	1900	1900	1900	1900
Lane Width (ft)	10	13	10	10	11	11
Grade (%)		-2%	2%		3%	
Lane Util. Factor	0.95	0.95	0.95	0.95	1.00	1.00
Ped Bike Factor		0.99	0.96		0.79	
Frt			0.980		0.941	
Flt Protected		0.995			0.973	
Satd. Flow (prot)	0	3213	2729	0	1256	0
Flt Permitted		0.861			0.973	
Satd. Flow (perm)	0	2745	2729	0	1162	0
Right Turn on Red				No		No
Satd. Flow (RTOR)						
Link Speed (mph)		20	20		20	
Link Distance (ft)		941	1200		366	
Travel Time (s)		32.1	40.9		12.5	
Confl. Peds. (#/hr)	119			119	130	370
Peak Hour Factor	0.95	0.95	0.92	0.92	0.87	0.87
Heavy Vehicles (%)	5%	5%	4%	4%	2%	2%
Parking (#/hr)						0
Adj. Flow (vph)	49	401	455	68	120	93
Shared Lane Traffic (%)						
Lane Group Flow (vph)	0	450	523	0	213	0
Turn Type	Perm	NA	NA		Prot	
Protected Phases		2	6		4	
Permitted Phases	2					
Detector Phase	2	2	6		4	
Switch Phase						
Minimum Initial (s)	10.0	10.0	10.0		7.0	
Minimum Split (s)	17.0	17.0	22.0		25.0	
Total Split (s)	32.0	32.0	32.0		33.0	
Total Split (%)	49.2%	49.2%	49.2%		50.8%	
Maximum Green (s)	25.8	25.8	25.9		27.9	
Yellow Time (s)	3.0	3.0	3.0		3.0	
All-Red Time (s)	3.2	3.2	3.1		2.1	
Lost Time Adjust (s)		-1.2	-1.1		-0.1	
Total Lost Time (s)		5.0	5.0		5.0	
Lead/Lag						
Lead-Lag Optimize?						
Vehicle Extension (s)	2.0	2.0	2.0		1.0	
Recall Mode	C-Max	C-Max	C-Max		None	
Walk Time (s)			7.0		7.0	
Flash Dont Walk (s)			8.0		12.0	
Pedestrian Calls (#/hr)			0		0	
Act Effct Green (s)		40.1	40.1		14.9	
Actuated g/C Ratio		0.62	0.62		0.23	
v/c Ratio		0.27	0.31		0.74	

Lanes, Volumes, Timings
 10: E. Franklin Street & Henderson Street

09/01/2020



Lane Group	EBL	EBT	WBT	WBR	SBL	SBR
Control Delay		7.2	8.8		35.8	
Queue Delay		0.0	0.0		0.0	
Total Delay		7.2	8.8		35.8	
LOS		A	A		D	
Approach Delay		7.2	8.8		35.8	
Approach LOS		A	A		D	
Queue Length 50th (ft)		16	38		91	
Queue Length 95th (ft)		170	170		129	
Internal Link Dist (ft)		861	1120		286	
Turn Bay Length (ft)						
Base Capacity (vph)		1691	1681		541	
Starvation Cap Reductn		0	0		0	
Spillback Cap Reductn		0	0		0	
Storage Cap Reductn		0	0		0	
Reduced v/c Ratio		0.27	0.31		0.39	

Intersection Summary

Area Type:	CBD
Cycle Length:	65
Actuated Cycle Length:	65
Offset:	4 (6%), Referenced to phase 2:EBTL and 6:WBT, Start of Green
Natural Cycle:	50
Control Type:	Actuated-Coordinated
Maximum v/c Ratio:	0.74
Intersection Signal Delay:	13.0
Intersection LOS:	B
Intersection Capacity Utilization:	57.6%
ICU Level of Service:	B
Analysis Period (min):	15

Splits and Phases: 10: E. Franklin Street & Henderson Street

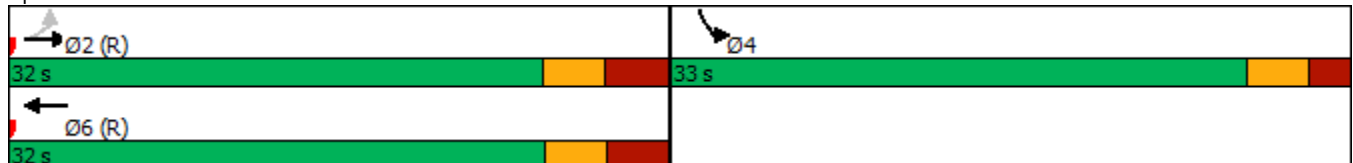

Lanes, Volumes, Timings

11: Raleigh Street/Hillsborough Street & E. Franklin Street

09/01/2020



Lane Group	EBL	EBT	EBR	WBL	WBT	WBR	NBL	NBT	NBR	SBL	SBT	SBR
Lane Configurations	↖	↗		↖	↗			↕		↖	↗	
Traffic Volume (vph)	56	339	151	41	379	150	87	165	23	75	198	23
Future Volume (vph)	56	339	151	41	379	150	87	165	23	75	198	23
Ideal Flow (vphpl)	1900	1900	1900	1900	1900	1900	1900	1900	1900	1900	1900	1900
Lane Width (ft)	9	9	10	9	10	11	12	12	12	10	10	10
Grade (%)		1%			-2%			1%			1%	
Storage Length (ft)	75		0	75		0	0		0	100		0
Storage Lanes	1		0	1		0	0		0	1		0
Taper Length (ft)	25			25			25			25		
Lane Util. Factor	1.00	0.95	0.95	1.00	0.95	0.95	1.00	1.00	1.00	1.00	1.00	1.00
Ped Bike Factor	0.98	0.98		0.99	0.98			0.97		0.97	0.98	
Frt		0.954			0.957			0.989			0.984	
Flt Protected	0.950			0.950				0.984		0.950		
Satd. Flow (prot)	1539	2893	0	1593	3092	0	0	1794	0	1612	1639	0
Flt Permitted	0.401			0.423				0.673		0.499		
Satd. Flow (perm)	634	2893	0	700	3092	0	0	1197	0	821	1639	0
Right Turn on Red			No			No			No			No
Satd. Flow (RTOR)												
Link Speed (mph)		20			30			25			25	
Link Distance (ft)		1200			1013			995			363	
Travel Time (s)		40.9			23.0			27.1			9.9	
Confl. Peds. (#/hr)	50		25	25		50	93		33	33		93
Peak Hour Factor	0.91	0.91	0.91	0.91	0.91	0.91	0.94	0.94	0.94	0.90	0.90	0.90
Heavy Vehicles (%)	5%	5%	5%	3%	3%	3%	2%	2%	2%	4%	4%	4%
Adj. Flow (vph)	62	373	166	45	416	165	93	176	24	83	220	26
Shared Lane Traffic (%)												
Lane Group Flow (vph)	62	539	0	45	581	0	0	293	0	83	246	0
Turn Type	Perm	NA		Perm	NA		pm+pt	NA		D.Pm	NA	
Protected Phases		2			6		7	4				8
Permitted Phases	2			6			4			4		
Detector Phase	2	2		6	6		7	4		4		8
Switch Phase												
Minimum Initial (s)	10.0	10.0		10.0	10.0		7.0	7.0		7.0	7.0	
Minimum Split (s)	16.0	16.0		16.0	16.0		14.0	30.0		30.0	29.0	
Total Split (s)	60.0	60.0		60.0	60.0		31.0	70.0		70.0	39.0	
Total Split (%)	46.2%	46.2%		46.2%	46.2%		23.8%	53.8%		53.8%	30.0%	
Maximum Green (s)	54.7	54.7		54.7	54.7		24.8	63.6		63.6	32.6	
Yellow Time (s)	3.0	3.0		3.0	3.0		3.0	3.1		3.1	3.1	
All-Red Time (s)	2.3	2.3		2.3	2.3		3.2	3.3		3.3	3.3	
Lost Time Adjust (s)	-0.3	-0.3		-0.3	-0.3			-1.4		-1.4	-1.4	
Total Lost Time (s)	5.0	5.0		5.0	5.0			5.0		5.0	5.0	
Lead/Lag							Lead				Lag	
Lead-Lag Optimize?												
Vehicle Extension (s)	3.0	3.0		3.0	3.0		3.0	2.0		2.0	2.0	
Recall Mode	C-Max	C-Max		C-Max	C-Max		None	None		None	None	
Walk Time (s)								7.0		7.0	7.0	
Flash Dont Walk (s)								16.0		16.0	15.0	
Pedestrian Calls (#/hr)								0		0	0	
Act Effect Green (s)	77.2	77.2		77.2	77.2			42.8		42.8	42.8	

Lanes, Volumes, Timings

11: Raleigh Street/Hillsborough Street & E. Franklin Street

09/01/2020



Lane Group	EBL	EBT	EBR	WBL	WBT	WBR	NBL	NBT	NBR	SBL	SBT	SBR
Actuated g/C Ratio	0.59	0.59		0.59	0.59			0.33		0.33	0.33	
v/c Ratio	0.16	0.31		0.11	0.32			0.75		0.31	0.46	
Control Delay	15.4	12.8		16.0	15.5			49.3		30.0	33.6	
Queue Delay	0.0	0.0		0.0	0.0			0.0		0.0	4.0	
Total Delay	15.4	12.8		16.0	15.5			49.3		30.0	37.6	
LOS	B	B		B	B			D		C	D	
Approach Delay		13.1			15.5			49.3			35.7	
Approach LOS		B			B			D			D	
Queue Length 50th (ft)	13	66		16	122			218		49	154	
Queue Length 95th (ft)	57	171		46	206			276		79	197	
Internal Link Dist (ft)		1120			933			915			283	
Turn Bay Length (ft)	75			75						100		
Base Capacity (vph)	376	1717		415	1836			598		410	555	
Starvation Cap Reductn	0	0		0	0			0		0	228	
Spillback Cap Reductn	0	0		0	0			0		0	0	
Storage Cap Reductn	0	0		0	0			0		0	0	
Reduced v/c Ratio	0.16	0.31		0.11	0.32			0.49		0.20	0.75	

Intersection Summary





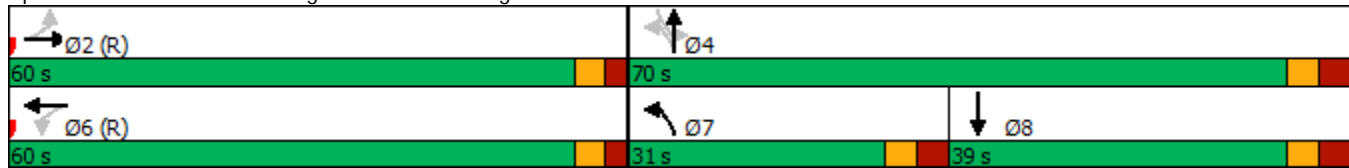













Area Type:	Other
Cycle Length:	130
Actuated Cycle Length:	130
Offset:	57 (44%), Referenced to phase 2:EBTL and 6:WBTL, Start of Green
Natural Cycle:	60
Control Type:	Actuated-Coordinated
Maximum v/c Ratio:	0.75
Intersection Signal Delay:	23.7
Intersection LOS:	C
Intersection Capacity Utilization:	77.3%
ICU Level of Service:	D
Analysis Period (min):	15

Splits and Phases: 11: Raleigh Street/Hillsborough Street & E. Franklin Street



Lanes, Volumes, Timings

13: NC 86 (N. Columbia St)/NC 86 (MLK Jr. Blvd) & North Street & N. Columbia Street 09/01/2020

												
Lane Group	WBL	WBR	WBR2	NBL	NBT	NBR	SBL	SBT	SBR	SEL2	SEL	SER
Lane Configurations												
Traffic Volume (vph)	8	9	85	44	470	4	63	533	6	1	7	60
Future Volume (vph)	8	9	85	44	470	4	63	533	6	1	7	60
Ideal Flow (vphpl)	1900	1900	1900	1900	1900	1900	1900	1900	1900	1900	1900	1900
Grade (%)	2%				-5%			5%				-3%
Storage Length (ft)	0	50		150		0	70		0		0	0
Storage Lanes	1	1		1		0	1		0		1	0
Taper Length (ft)	25			25			25				25	
Lane Util. Factor	1.00	1.00	1.00	1.00	0.95	0.95	1.00	0.95	0.95	1.00	1.00	1.00
Ped Bike Factor			0.98	1.00	1.00		0.98	1.00			1.00	
Frt	0.922		0.850		0.999			0.998			0.880	
Flt Protected	0.977			0.950			0.950				0.994	
Satd. Flow (prot)	1661	0	1567	1729	3453	0	1676	3344	0	0	1562	0
Flt Permitted	0.977			0.405			0.459				0.994	
Satd. Flow (perm)	1661	0	1535	735	3453	0	792	3344	0	0	1560	0
Right Turn on Red			Yes			Yes			Yes			Yes
Satd. Flow (RTOR)			113		1			1			92	
Link Speed (mph)	20				35			35			25	
Link Distance (ft)	264				476			2108			715	
Travel Time (s)	9.0				9.3			41.1			19.5	
Confl. Peds. (#/hr)			8	6		41	41		6	8		
Peak Hour Factor	0.75	0.75	0.75	0.93	0.93	0.93	0.87	0.87	0.87	0.75	0.75	0.75
Heavy Vehicles (%)	2%	2%	2%	7%	7%	7%	5%	5%	5%	8%	8%	8%
Adj. Flow (vph)	11	12	113	47	505	4	72	613	7	1	9	80
Shared Lane Traffic (%)												
Lane Group Flow (vph)	23	0	113	47	509	0	72	620	0	0	90	0
Turn Type	Prot		Perm	Perm	NA		Perm	NA		Prot	Prot	
Protected Phases	3				2			6		4	4	
Permitted Phases			3	2			6					
Detector Phase	3		3	2	2		6	6		4	4	
Switch Phase												
Minimum Initial (s)	7.0		7.0	10.0	10.0		10.0	10.0		7.0	7.0	
Minimum Split (s)	14.0		14.0	17.0	17.0		17.0	17.0		14.0	14.0	
Total Split (s)	39.0		39.0	61.0	61.0		61.0	61.0		30.0	30.0	
Total Split (%)	30.0%		30.0%	46.9%	46.9%		46.9%	46.9%		23.1%	23.1%	
Maximum Green (s)	32.0		32.0	54.0	54.0		54.0	54.0		23.0	23.0	
Yellow Time (s)	5.0		5.0	5.0	5.0		5.0	5.0		5.0	5.0	
All-Red Time (s)	2.0		2.0	2.0	2.0		2.0	2.0		2.0	2.0	
Lost Time Adjust (s)	-2.0		-2.0	-2.0	-2.0		-2.0	-2.0			-2.0	
Total Lost Time (s)	5.0		5.0	5.0	5.0		5.0	5.0			5.0	
Lead/Lag	Lead		Lead							Lag	Lag	
Lead-Lag Optimize?	Yes		Yes							Yes	Yes	
Vehicle Extension (s)	3.0		3.0	3.0	3.0		3.0	3.0		3.0	3.0	
Recall Mode	None		None	C-Max	C-Max		C-Max	C-Max		None	None	
Act Effct Green (s)	10.3		10.3	94.9	94.9		94.9	94.9			9.9	
Actuated g/C Ratio	0.08		0.08	0.73	0.73		0.73	0.73			0.08	
v/c Ratio	0.18		0.50	0.09	0.20		0.12	0.25			0.44	
Control Delay	58.2		17.7	3.5	3.5		6.4	6.4			17.5	
Queue Delay	0.0		0.0	0.0	0.0		0.0	0.0			0.0	

Lanes, Volumes, Timings

13: NC 86 (N. Columbia St)/NC 86 (MLK Jr. Blvd) & North Street & N. Columbia Street 09/01/2020



Lane Group	WBL	WBR	WBR2	NBL	NBT	NBR	SBL	SBT	SBR	SEL2	SEL	SER
Total Delay	58.2		17.7	3.5	3.5		6.4	6.4				17.5
LOS	E		B	A	A		A	A				B
Approach Delay	24.5				3.5			6.4				17.5
Approach LOS	C				A			A				B
Queue Length 50th (ft)	19		0	6	37		15	75				0
Queue Length 95th (ft)	39		32	m14	47		37	121				29
Internal Link Dist (ft)	184				396			2028				635
Turn Bay Length (ft)			50	150			70					
Base Capacity (vph)	434		484	536	2520		577	2440				374
Starvation Cap Reductn	0		0	0	0		0	0				0
Spillback Cap Reductn	0		0	0	0		0	0				0
Storage Cap Reductn	0		0	0	0		0	0				0
Reduced v/c Ratio	0.05		0.23	0.09	0.20		0.12	0.25				0.24

Intersection Summary

Area Type: Other
 Cycle Length: 130
 Actuated Cycle Length: 130
 Offset: 82 (63%), Referenced to phase 2:NBTL and 6:SBTL, Start of Green
 Natural Cycle: 45
 Control Type: Actuated-Coordinated
 Maximum v/c Ratio: 0.50
 Intersection Signal Delay: 7.6
 Intersection LOS: A
 Intersection Capacity Utilization 51.6%
 ICU Level of Service A
 Analysis Period (min) 15
 m Volume for 95th percentile queue is metered by upstream signal.

Splits and Phases: 13: NC 86 (N. Columbia St)/NC 86 (MLK Jr. Blvd) & North Street & N. Columbia Street

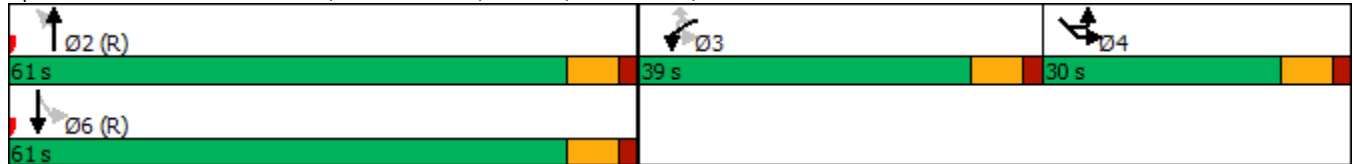

Lanes, Volumes, Timings

14: NC 86 (MLK Jr. Blvd) & Longview Street/Mill Creek Apts Driveway

09/01/2020



Lane Group	EBL	EBT	EBR	WBL	WBT	WBR	NBL	NBT	NBR	SBL	SBT	SBR
Lane Configurations		↕			↕		↕	↕		↕	↕	
Traffic Volume (vph)	37	0	19	4	0	2	7	525	8	1	578	35
Future Volume (vph)	37	0	19	4	0	2	7	525	8	1	578	35
Ideal Flow (vphpl)	1900	1900	1900	1900	1900	1900	1900	1900	1900	1900	1900	1900
Grade (%)		-6%			1%			2%			-4%	
Storage Length (ft)	0		0	0		0	225		0	250		0
Storage Lanes	0		0	0		0	1		0	1		0
Taper Length (ft)	25			25			25			25		
Lane Util. Factor	1.00	1.00	1.00	1.00	1.00	1.00	1.00	0.95	0.95	1.00	0.95	0.95
Ped Bike Factor		0.99			0.98		0.99	1.00		0.98	1.00	
Frt		0.954			0.955			0.998			0.992	
Flt Protected		0.968			0.968		0.950			0.950		
Satd. Flow (prot)	0	1720	0	0	1706	0	1670	3331	0	1753	3472	0
Flt Permitted		0.794			0.754		0.396			0.426		
Satd. Flow (perm)	0	1410	0	0	1314	0	692	3331	0	774	3472	0
Right Turn on Red			No			No			No			No
Satd. Flow (RTOR)												
Link Speed (mph)		25			20			35			35	
Link Distance (ft)		451			338			2108			784	
Travel Time (s)		12.3			11.5			41.1			15.3	
Confl. Peds. (#/hr)	1		19	19		1	7		15	15		7
Peak Hour Factor	0.76	0.76	0.76	0.50	0.50	0.50	0.89	0.89	0.89	0.91	0.91	0.91
Heavy Vehicles (%)	4%	4%	4%	2%	2%	2%	7%	7%	7%	5%	5%	5%
Adj. Flow (vph)	49	0	25	8	0	4	8	590	9	1	635	38
Shared Lane Traffic (%)												
Lane Group Flow (vph)	0	74	0	0	12	0	8	599	0	1	673	0
Turn Type	Perm	NA		Perm	NA		Perm	NA		Perm	NA	
Protected Phases		4			8			2			6	
Permitted Phases	4			8			2			6		
Detector Phase	4	4		8	8		2	2		6	6	
Switch Phase												
Minimum Initial (s)	7.0	7.0		7.0	7.0		12.0	12.0		12.0	12.0	
Minimum Split (s)	31.0	31.0		14.0	14.0		28.0	28.0		28.0	28.0	
Total Split (s)	20.0	20.0		20.0	20.0		60.0	60.0		60.0	60.0	
Total Split (%)	25.0%	25.0%		25.0%	25.0%		75.0%	75.0%		75.0%	75.0%	
Maximum Green (s)	14.0	14.0		13.9	13.9		54.0	54.0		54.5	54.5	
Yellow Time (s)	3.5	3.5		3.0	3.0		4.5	4.5		4.0	4.0	
All-Red Time (s)	2.5	2.5		3.1	3.1		1.5	1.5		1.5	1.5	
Lost Time Adjust (s)		-1.0			-1.0		-1.0	-1.0		-0.5	-0.5	
Total Lost Time (s)		5.0			5.1		5.0	5.0		5.0	5.0	
Lead/Lag												
Lead-Lag Optimize?												
Vehicle Extension (s)	3.0	3.0		3.0	3.0		3.0	3.0		3.0	3.0	
Recall Mode	None	None		None	None		Min	Min		Min	Min	
Walk Time (s)	7.0	7.0					7.0	7.0		7.0	7.0	
Flash Dont Walk (s)	17.0	17.0					9.0	9.0		9.0	9.0	
Pedestrian Calls (#/hr)	0	0					0	0		0	0	
Act Effct Green (s)		8.7			8.6		24.6	24.6		24.6	24.6	
Actuated g/C Ratio		0.24			0.24		0.69	0.69		0.69	0.69	

Lanes, Volumes, Timings

14: NC 86 (MLK Jr. Blvd) & Longview Street/Mill Creek Apts Driveway

09/01/2020



Lane Group	EBL	EBT	EBR	WBL	WBT	WBR	NBL	NBT	NBR	SBL	SBT	SBR
v/c Ratio		0.22			0.04		0.02	0.26		0.00	0.28	
Control Delay		12.8			11.0		5.4	5.1		5.0	5.1	
Queue Delay		0.0			0.0		0.0	0.0		0.0	0.0	
Total Delay		12.8			11.0		5.4	5.1		5.0	5.1	
LOS		B			B		A	A		A	A	
Approach Delay		12.8			11.0			5.1			5.1	
Approach LOS		B			B			A			A	
Queue Length 50th (ft)		14			2		1	33		0	37	
Queue Length 95th (ft)		28			5		5	61		2	70	
Internal Link Dist (ft)		371			258			2028			704	
Turn Bay Length (ft)							225			250		
Base Capacity (vph)		597			553		692	3331		774	3472	
Starvation Cap Reductn		0			0		0	0		0	0	
Spillback Cap Reductn		0			0		0	0		0	0	
Storage Cap Reductn		0			0		0	0		0	0	
Reduced v/c Ratio		0.12			0.02		0.01	0.18		0.00	0.19	

Intersection Summary

Area Type:	Other
Cycle Length:	80
Actuated Cycle Length:	35.6
Natural Cycle:	60
Control Type:	Actuated-Uncoordinated
Maximum v/c Ratio:	0.28
Intersection Signal Delay:	5.6
Intersection LOS:	A
Intersection Capacity Utilization:	37.9%
ICU Level of Service:	A
Analysis Period (min):	15

Splits and Phases: 14: NC 86 (MLK Jr. Blvd) & Longview Street/Mill Creek Apts Driveway

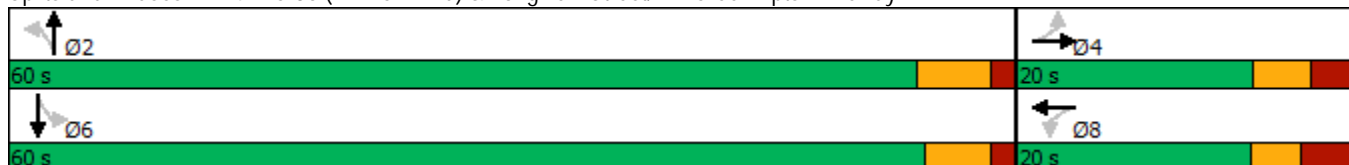

Lanes, Volumes, Timings
 15: NC 86 (Pittsboro St) & W. Cameron Avenue

09/01/2020



Lane Group	EBT	EBR	WBL	WBT	NBL	NBR	Ø1	Ø4
Lane Configurations	↷		↶↶	↶				
Traffic Volume (vph)	80	154	463	218	0	0		
Future Volume (vph)	80	154	463	218	0	0		
Ideal Flow (vphpl)	1900	1900	1900	1900	1900	1900		
Lane Width (ft)	12	12	11	12	12	12		
Grade (%)	3%			-3%	0%			
Storage Length (ft)		0	75		0	0		
Storage Lanes		0	0		0	0		
Taper Length (ft)			25		25			
Lane Util. Factor	1.00	1.00	0.97	1.00	1.00	1.00		
Ped Bike Factor	0.78		0.65					
Frt	0.911							
Flt Protected			0.950					
Satd. Flow (prot)	1171	0	2837	1592	0	0		
Flt Permitted			0.950					
Satd. Flow (perm)	1171	0	1846	1592	0	0		
Right Turn on Red		No				No		
Satd. Flow (RTOR)								
Link Speed (mph)	25			25	25			
Link Distance (ft)	391			120	794			
Travel Time (s)	30.0			10.7	21.7			
Confl. Peds. (#/hr)		129	129					
Peak Hour Factor	0.71	0.71	0.93	0.93	0.90	0.90		
Heavy Vehicles (%)	2%	2%	9%	9%	2%	2%		
Adj. Flow (vph)	113	217	498	234	0	0		
Shared Lane Traffic (%)								
Lane Group Flow (vph)	330	0	498	234	0	0		
Turn Type	NA		Prot	NA				
Protected Phases	2		1 4	6			1	4
Permitted Phases								
Detector Phase	2		1 4	6				
Switch Phase								
Minimum Initial (s)	10.0			10.0			7.0	7.0
Minimum Split (s)	20.0			20.0			20.0	20.0
Total Split (s)	77.0			110.0			33.0	20.0
Total Split (%)	59.2%			84.6%			25%	15%
Maximum Green (s)	71.9			105.0			27.9	16.0
Yellow Time (s)	3.0			3.3			3.0	3.0
All-Red Time (s)	2.1			1.7			2.1	1.0
Lost Time Adjust (s)	-0.1			0.0				
Total Lost Time (s)	5.0			5.0				
Lead/Lag	Lag						Lead	
Lead-Lag Optimize?								
Vehicle Extension (s)	1.0			1.0			4.0	0.2
Recall Mode	None			C-Max			C-Max	None
Walk Time (s)	7.0							7.0
Flash Dont Walk (s)	4.0							9.0
Pedestrian Calls (#/hr)	0							0
Act Effect Green (s)	72.0		48.0	105.4				

Lanes, Volumes, Timings
 15: NC 86 (Pittsboro St) & W. Cameron Avenue

09/01/2020



Lane Group	EBT	EBR	WBL	WBT	NBL	NBR	Ø1	Ø4
Actuated g/C Ratio	0.55		0.37	0.81				
v/c Ratio	0.51		0.48	0.18				
Control Delay	21.5		26.4	3.3				
Queue Delay	0.0		1.3	0.6				
Total Delay	21.5		27.7	3.9				
LOS	C		C	A				
Approach Delay	21.5			20.1				
Approach LOS	C			C				
Queue Length 50th (ft)	166		167	31				
Queue Length 95th (ft)	177		251	m64				
Internal Link Dist (ft)	311			40	714			
Turn Bay Length (ft)			75					
Base Capacity (vph)	648		1033	1290				
Starvation Cap Reductn	0		326	721				
Spillback Cap Reductn	0		0	0				
Storage Cap Reductn	0		0	0				
Reduced v/c Ratio	0.51		0.70	0.41				

Intersection Summary

Area Type: CBD
 Cycle Length: 130
 Actuated Cycle Length: 130
 Offset: 28 (22%), Referenced to phase 1:WBL and 6:WBT, Start of Green
 Natural Cycle: 65
 Control Type: Actuated-Coordinated
 Maximum v/c Ratio: 0.51
 Intersection Signal Delay: 20.5 Intersection LOS: C
 Intersection Capacity Utilization 42.6% ICU Level of Service A
 Analysis Period (min) 15
 m Volume for 95th percentile queue is metered by upstream signal.

Splits and Phases: 15: NC 86 (Pittsboro St) & W. Cameron Avenue

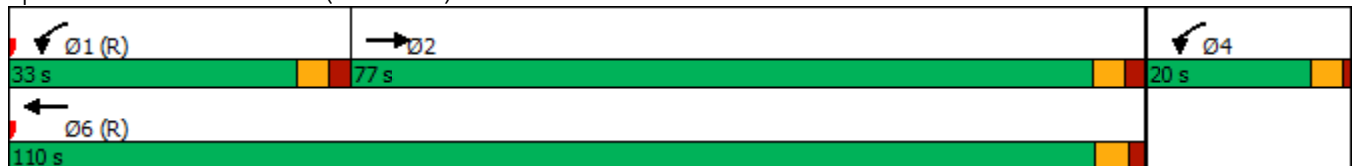

Lanes, Volumes, Timings

16: NC 86 (S. Columbia St) & W. Cameron Avenue/E. Cameron Avenue

09/01/2020



Lane Group	EBL	EBT	EBR	WBL	WBT	WBR	NBL	NBT	NBR	SBL	SBT	SBR
Lane Configurations												
Traffic Volume (vph)	21	52	0	0	91	37	171	398	27	43	0	418
Future Volume (vph)	21	52	0	0	91	37	171	398	27	43	0	418
Ideal Flow (vphpl)	1900	1900	1900	1900	1900	1900	1900	1900	1900	1900	1900	1900
Lane Width (ft)	11	12	12	12	12	12	10	10	10	11	11	12
Grade (%)		1%			-1%			1%			2%	
Storage Length (ft)	100		0	0		0	0		0	310		0
Storage Lanes	1		0	0		0	1		0	1		2
Taper Length (ft)	25			25			25			25		
Lane Util. Factor	1.00	1.00	1.00	1.00	1.00	1.00	0.91	0.91	0.95	1.00	1.00	0.88
Ped Bike Factor	0.77				0.91		0.60	0.94		0.62		0.43
Frt					0.961			0.991				0.850
Flt Protected	0.950						0.950	0.998		0.950		
Satd. Flow (prot)	1488	1620	0	0	1404	0	1259	2499	0	1439	0	2345
Flt Permitted	0.487						0.950	0.998		0.950		
Satd. Flow (perm)	588	1620	0	0	1404	0	757	2460	0	891	0	1014
Right Turn on Red			No			No			No			No
Satd. Flow (RTOR)												
Link Speed (mph)		25			25			25			25	
Link Distance (ft)		273			989			826			981	
Travel Time (s)		10.7			57.6			22.5			26.8	
Confl. Peds. (#/hr)	207		358	358		207	244		349	349		244
Peak Hour Factor	0.93	0.93	0.93	0.84	0.84	0.84	0.86	0.86	0.86	0.86	0.86	0.86
Heavy Vehicles (%)	5%	5%	5%	7%	7%	7%	9%	9%	9%	8%	8%	8%
Adj. Flow (vph)	23	56	0	0	108	44	199	463	31	50	0	486
Shared Lane Traffic (%)							10%					
Lane Group Flow (vph)	23	56	0	0	152	0	179	514	0	50	0	486
Turn Type	Perm	NA			NA		Split	NA		Prot		Prot
Protected Phases		4			8		2	2		1		1
Permitted Phases	4									1		1
Detector Phase	4	4			8		2	2		1		1
Switch Phase												
Minimum Initial (s)	10.0	10.0			10.0		7.0	7.0		7.0		7.0
Minimum Split (s)	24.0	24.0			31.0		18.0	18.0		26.0		26.0
Total Split (s)	40.0	40.0			40.0		23.0	23.0		39.0		39.0
Total Split (%)	30.8%	30.8%			30.8%		17.7%	17.7%		30.0%		30.0%
Maximum Green (s)	33.8	33.8			33.8		17.1	17.1		33.4		33.4
Yellow Time (s)	3.2	3.2			3.2		3.1	3.1		3.0		3.0
All-Red Time (s)	3.0	3.0			3.0		2.8	2.8		2.6		2.6
Lost Time Adjust (s)	-1.2	-1.2			-1.2		-0.9	-0.9		-0.6		-0.6
Total Lost Time (s)	5.0	5.0			5.0		5.0	5.0		5.0		5.0
Lead/Lag							Lead	Lead		Lag		Lag
Lead-Lag Optimize?												
Vehicle Extension (s)	2.0	2.0			2.0		4.0	4.0		4.0		4.0
Recall Mode	None	None			None		C-Max	C-Max		None		None
Walk Time (s)	7.0	7.0			7.0		7.0	7.0		7.0		7.0
Flash Dont Walk (s)	10.0	10.0			17.0		5.0	5.0		13.0		13.0
Pedestrian Calls (#/hr)	0	0			0		0	0		0		0
Act Effect Green (s)	19.7	19.7			19.7		63.7	63.7		31.6		31.6

Lanes, Volumes, Timings

16: NC 86 (S. Columbia St) & W. Cameron Avenue/E. Cameron Avenue

09/01/2020

Lane Group	Ø9
Lane Configurations	
Traffic Volume (vph)	
Future Volume (vph)	
Ideal Flow (vphpl)	
Lane Width (ft)	
Grade (%)	
Storage Length (ft)	
Storage Lanes	
Taper Length (ft)	
Lane Util. Factor	
Ped Bike Factor	
Frt	
Flt Protected	
Satd. Flow (prot)	
Flt Permitted	
Satd. Flow (perm)	
Right Turn on Red	
Satd. Flow (RTOR)	
Link Speed (mph)	
Link Distance (ft)	
Travel Time (s)	
Confl. Peds. (#/hr)	
Peak Hour Factor	
Heavy Vehicles (%)	
Adj. Flow (vph)	
Shared Lane Traffic (%)	
Lane Group Flow (vph)	
Turn Type	
Protected Phases	9
Permitted Phases	
Detector Phase	
Switch Phase	
Minimum Initial (s)	7.0
Minimum Split (s)	28.0
Total Split (s)	28.0
Total Split (%)	22%
Maximum Green (s)	24.0
Yellow Time (s)	3.0
All-Red Time (s)	1.0
Lost Time Adjust (s)	
Total Lost Time (s)	
Lead/Lag	
Lead-Lag Optimize?	
Vehicle Extension (s)	0.2
Recall Mode	None
Walk Time (s)	7.0
Flash Dont Walk (s)	17.0
Pedestrian Calls (#/hr)	0
Act Effect Green (s)	

Lanes, Volumes, Timings

16: NC 86 (S. Columbia St) & W. Cameron Avenue/E. Cameron Avenue

09/01/2020



Lane Group	EBL	EBT	EBR	WBL	WBT	WBR	NBL	NBT	NBR	SBL	SBT	SBR
Actuated g/C Ratio	0.15	0.15			0.15		0.49	0.49		0.24		0.24
v/c Ratio	0.26	0.23			0.72		0.29	0.42		0.14		0.85
Control Delay	38.8	33.8			70.1		23.6	24.3		18.9		37.5
Queue Delay	0.0	0.0			0.0		0.0	0.0		0.0		0.0
Total Delay	38.8	33.8			70.1		23.6	24.3		18.9		37.5
LOS	D	C			E		C	C		B		D
Approach Delay		35.2			70.1			24.1			35.7	
Approach LOS		D			E			C			D	
Queue Length 50th (ft)	18	43			123		100	154		18		204
Queue Length 95th (ft)	m36	86			173		171	217		m33		293
Internal Link Dist (ft)		193			909			746			901	
Turn Bay Length (ft)	100									310		
Base Capacity (vph)	158	436			378		616	1223		376		613
Starvation Cap Reductn	0	0			0		0	0		0		0
Spillback Cap Reductn	0	0			0		0	0		0		0
Storage Cap Reductn	0	0			0		0	0		0		0
Reduced v/c Ratio	0.15	0.13			0.40		0.29	0.42		0.13		0.79

Intersection Summary

Area Type: CBD
 Cycle Length: 130
 Actuated Cycle Length: 130
 Offset: 67 (52%), Referenced to phase 2:NBTL, Start of Green
 Natural Cycle: 105
 Control Type: Actuated-Coordinated
 Maximum v/c Ratio: 0.85
 Intersection Signal Delay: 33.8
 Intersection LOS: C
 Intersection Capacity Utilization 69.8%
 ICU Level of Service C
 Analysis Period (min) 15
 m Volume for 95th percentile queue is metered by upstream signal.

Splits and Phases: 16: NC 86 (S. Columbia St) & W. Cameron Avenue/E. Cameron Avenue

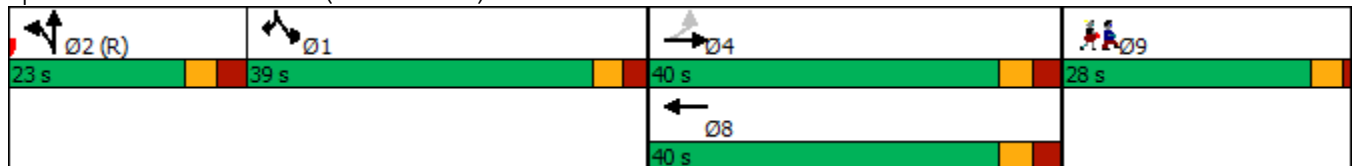

Lanes, Volumes, Timings

16: NC 86 (S. Columbia St) & W. Cameron Avenue/E. Cameron Avenue

09/01/2020

Lane Group	Ø9
Actuated g/C Ratio	
v/c Ratio	
Control Delay	
Queue Delay	
Total Delay	
LOS	
Approach Delay	
Approach LOS	
Queue Length 50th (ft)	
Queue Length 95th (ft)	
Internal Link Dist (ft)	
Turn Bay Length (ft)	
Base Capacity (vph)	
Starvation Cap Reductn	
Spillback Cap Reductn	
Storage Cap Reductn	
Reduced v/c Ratio	
Intersection Summary	

Lanes, Volumes, Timings

17: Raleigh Street & E. Cameron Avenue/Country Club Road

09/01/2020



Lane Group	EBL	EBT	EBR	WBL	WBT	WBR	NBL	NBT	NBR	SBL	SBT	SBR
Lane Configurations		↕		↖	↗		↖	↗		↖	↗	
Traffic Volume (vph)	31	65	33	21	87	172	33	77	28	240	112	44
Future Volume (vph)	31	65	33	21	87	172	33	77	28	240	112	44
Ideal Flow (vphpl)	1900	1900	1900	1900	1900	1900	1900	1900	1900	1900	1900	1900
Grade (%)		-3%			3%			-2%				1%
Storage Length (ft)	0		0	150		0	125		0	75		0
Storage Lanes	0		0	1		0	1		0	1		0
Taper Length (ft)	25			25			25			25		
Lane Util. Factor	1.00	1.00	1.00	1.00	1.00	1.00	1.00	1.00	1.00	1.00	1.00	1.00
Ped Bike Factor		0.91		0.90	0.87		0.67	0.95		0.87	0.85	
Frt		0.966			0.901			0.960			0.958	
Flt Protected		0.988		0.950			0.950			0.950		
Satd. Flow (prot)	0	1517	0	1569	1291	0	1505	1450	0	1554	1331	0
Flt Permitted		0.844		0.536			0.653			0.455		
Satd. Flow (perm)	0	1257	0	795	1291	0	698	1450	0	649	1331	0
Right Turn on Red			No			No			No			No
Satd. Flow (RTOR)												
Link Speed (mph)		25			25			25				25
Link Distance (ft)		598			651			409				995
Travel Time (s)		16.3			17.8			11.2				27.1
Confl. Peds. (#/hr)	38		43	43		38	103		33	33		103
Peak Hour Factor	0.87	0.87	0.87	0.91	0.91	0.91	0.93	0.93	0.93	0.95	0.95	0.95
Heavy Vehicles (%)	2%	2%	2%	2%	2%	2%	9%	9%	9%	4%	4%	4%
Adj. Flow (vph)	36	75	38	23	96	189	35	83	30	253	118	46
Shared Lane Traffic (%)												
Lane Group Flow (vph)	0	149	0	23	285	0	35	113	0	253	164	0
Turn Type	Perm	NA		pm+pt	NA		pm+pt	NA		pm+pt	NA	
Protected Phases		2		1	6		3	8		7	4	
Permitted Phases	2			6			8			4		
Detector Phase	2	2		1	6		3	8		7	4	
Switch Phase												
Minimum Initial (s)	10.0	10.0		7.0	10.0		7.0	7.0		7.0	7.0	
Minimum Split (s)	18.0	18.0		13.0	19.0		13.0	19.0		12.0	16.0	
Total Split (s)	50.0	50.0		20.0	70.0		20.0	35.0		20.0	35.0	
Total Split (%)	40.0%	40.0%		16.0%	56.0%		16.0%	28.0%		16.0%	28.0%	
Maximum Green (s)	43.9	43.9		14.4	64.4		14.7	29.7		15.1	29.9	
Yellow Time (s)	3.3	3.3		3.0	3.1		3.0	3.1		3.0	3.1	
All-Red Time (s)	2.8	2.8		2.6	2.5		2.3	2.2		1.9	2.0	
Lost Time Adjust (s)		-1.1		-0.6	-0.6		-0.3	-0.3		0.1	-0.1	
Total Lost Time (s)		5.0		5.0	5.0		5.0	5.0		5.0	5.0	
Lead/Lag	Lag	Lag		Lead			Lead	Lag		Lead	Lag	
Lead-Lag Optimize?	Yes	Yes		Yes			Yes	Yes		Yes	Yes	
Vehicle Extension (s)	2.0	2.0		2.0	2.0		2.0	2.0		2.0	2.0	
Recall Mode	None	None		None	None		None	None		None	None	
Walk Time (s)	4.0	4.0			4.0			4.0			4.0	
Flash Dont Walk (s)	7.0	7.0			9.0			9.0			6.0	
Pedestrian Calls (#/hr)	0	0			0			0			0	
Act Effect Green (s)		16.3		20.0	20.0		16.0	10.6		24.9	21.2	
Actuated g/C Ratio		0.29		0.36	0.36		0.28	0.19		0.44	0.38	

Lanes, Volumes, Timings

17: Raleigh Street & E. Cameron Avenue/Country Club Road

09/01/2020

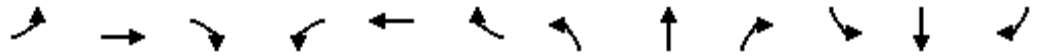

Lane Group	EBL	EBT	EBR	WBL	WBT	WBR	NBL	NBT	NBR	SBL	SBT	SBR
v/c Ratio		0.41		0.06	0.62		0.11	0.41		0.50	0.33	
Control Delay		25.4		13.7	23.2		12.5	30.2		15.1	19.1	
Queue Delay		0.0		0.0	0.0		0.0	0.0		0.0	0.0	
Total Delay		25.4		13.7	23.2		12.5	30.2		15.1	19.1	
LOS		C		B	C		B	C		B	B	
Approach Delay		25.4			22.5			26.0			16.7	
Approach LOS		C			C			C			B	
Queue Length 50th (ft)		40		6	86		5	35		45	28	
Queue Length 95th (ft)		111		19	172		25	96		131	119	
Internal Link Dist (ft)		518			571			329			915	
Turn Bay Length (ft)				150			125			75		
Base Capacity (vph)		996		544	1250		549	862		589	791	
Starvation Cap Reductn		0		0	0		0	0		0	0	
Spillback Cap Reductn		0		0	0		0	0		0	0	
Storage Cap Reductn		0		0	0		0	0		0	0	
Reduced v/c Ratio		0.15		0.04	0.23		0.06	0.13		0.43	0.21	

Intersection Summary

Area Type: CBD
 Cycle Length: 125
 Actuated Cycle Length: 56.2
 Natural Cycle: 65
 Control Type: Actuated-Uncoordinated
 Maximum v/c Ratio: 0.62
 Intersection Signal Delay: 21.0
 Intersection Capacity Utilization 69.1%
 Analysis Period (min) 15
 Intersection LOS: C
 ICU Level of Service C

Splits and Phases: 17: Raleigh Street & E. Cameron Avenue/Country Club Road



Lanes, Volumes, Timings
1: Church Street & W. Rosemary Street

09/01/2020



Lane Group	EBL	EBT	EBR	WBL	WBT	WBR	NBL	NBT	NBR	SBL	SBT	SBR
Lane Configurations		↕			↕			↕			↕	
Traffic Volume (vph)	24	428	66	65	451	37	47	80	65	24	76	26
Future Volume (vph)	24	428	66	65	451	37	47	80	65	24	76	26
Ideal Flow (vphpl)	1900	1900	1900	1900	1900	1900	1900	1900	1900	1900	1900	1900
Lane Width (ft)	12	14	12	12	14	12	12	12	12	12	12	12
Grade (%)		1%			-1%			0%			0%	
Lane Util. Factor	1.00	1.00	1.00	1.00	1.00	1.00	1.00	1.00	1.00	1.00	1.00	1.00
Ped Bike Factor		0.98			0.98			0.93			0.95	
Frt		0.983			0.991			0.955			0.972	
Flt Protected		0.998			0.994			0.988			0.991	
Satd. Flow (prot)	0	1710	0	0	1752	0	0	1515	0	0	1558	0
Flt Permitted		0.967			0.894			0.904			0.925	
Satd. Flow (perm)	0	1654	0	0	1568	0	0	1346	0	0	1436	0
Right Turn on Red			No			No			No			No
Satd. Flow (RTOR)												
Link Speed (mph)		20			20			25			25	
Link Distance (ft)		964			757			379			430	
Travel Time (s)		32.9			25.8			10.3			11.7	
Confl. Peds. (#/hr)	40		37	37		40	62		43	43		62
Peak Hour Factor	0.95	0.95	0.95	0.97	0.97	0.97	0.91	0.91	0.91	0.93	0.93	0.93
Adj. Flow (vph)	25	451	69	67	465	38	52	88	71	26	82	28
Shared Lane Traffic (%)												
Lane Group Flow (vph)	0	545	0	0	570	0	0	211	0	0	136	0
Turn Type	Perm	NA		Perm	NA		Perm	NA		Perm	NA	
Protected Phases		2			6			8			4	
Permitted Phases	2			6			8			4		
Detector Phase	2	2		6	6		8	8		4	4	
Switch Phase												
Minimum Initial (s)	10.0	10.0		10.0	10.0		7.0	7.0		7.0	7.0	
Minimum Split (s)	19.0	19.0		20.0	20.0		19.0	19.0		19.0	19.0	
Total Split (s)	45.0	45.0		45.0	45.0		25.0	25.0		25.0	25.0	
Total Split (%)	64.3%	64.3%		64.3%	64.3%		35.7%	35.7%		35.7%	35.7%	
Maximum Green (s)	40.5	40.5		40.4	40.4		20.1	20.1		20.1	20.1	
Yellow Time (s)	3.1	3.1		3.1	3.1		3.2	3.2		3.2	3.2	
All-Red Time (s)	1.4	1.4		1.5	1.5		1.7	1.7		1.7	1.7	
Lost Time Adjust (s)		0.5			0.4			0.1			0.1	
Total Lost Time (s)		5.0			5.0			5.0			5.0	
Lead/Lag												
Lead-Lag Optimize?												
Vehicle Extension (s)	3.0	3.0		3.0	3.0		3.0	3.0		3.0	3.0	
Recall Mode	C-Max	C-Max		C-Max	C-Max		None	None		None	None	
Walk Time (s)	4.0	4.0		4.0	4.0		4.0	4.0		4.0	4.0	
Flash Dont Walk (s)	5.0	5.0		6.0	6.0		10.0	10.0		10.0	10.0	
Pedestrian Calls (#/hr)	0	0		0	0		0	0		0	0	
Act Effct Green (s)		44.5			44.5			15.5			15.5	
Actuated g/C Ratio		0.64			0.64			0.22			0.22	
v/c Ratio		0.52			0.57			0.71			0.43	
Control Delay		10.1			5.6			37.0			26.6	
Queue Delay		0.0			0.0			0.0			0.0	

Lanes, Volumes, Timings
 1: Church Street & W. Rosemary Street

09/01/2020



Lane Group	EBL	EBT	EBR	WBL	WBT	WBR	NBL	NBT	NBR	SBL	SBT	SBR
Total Delay		10.1			5.6			37.0			26.6	
LOS		B			A			D			C	
Approach Delay		10.1			5.6			37.0			26.6	
Approach LOS		B			A			D			C	
Queue Length 50th (ft)		114			79			72			50	
Queue Length 95th (ft)		222			m84			m94			91	
Internal Link Dist (ft)		884			677			299			350	
Turn Bay Length (ft)												
Base Capacity (vph)		1051			996			384			410	
Starvation Cap Reductn		0			0			0			0	
Spillback Cap Reductn		0			0			0			0	
Storage Cap Reductn		0			0			0			0	
Reduced v/c Ratio		0.52			0.57			0.55			0.33	

Intersection Summary

Area Type: CBD
 Cycle Length: 70
 Actuated Cycle Length: 70
 Offset: 25 (36%), Referenced to phase 2:EBTL and 6:WBTL, Start of Green
 Natural Cycle: 55
 Control Type: Actuated-Coordinated
 Maximum v/c Ratio: 0.71
 Intersection Signal Delay: 13.8
 Intersection LOS: B
 Intersection Capacity Utilization 83.6%
 ICU Level of Service E
 Analysis Period (min) 15
 m Volume for 95th percentile queue is metered by upstream signal.

Splits and Phases: 1: Church Street & W. Rosemary Street



Lanes, Volumes, Timings

2: NC 86 (N. Columbia St) & W. Rosemary Street/E. Rosemary Street

09/01/2020



Lane Group	EBL	EBT	EBR	WBL	WBT	WBR	NBL	NBT	NBR	SBL	SBT	SBR
Lane Configurations												
Traffic Volume (vph)	232	275	49	117	243	63	52	597	96	68	515	277
Future Volume (vph)	232	275	49	117	243	63	52	597	96	68	515	277
Ideal Flow (vphpl)	1900	1900	1900	1900	1900	1900	1900	1900	1900	1900	1900	1900
Lane Width (ft)	9	12	13	12	12	12	9	10	12	12	9	11
Grade (%)		1%			1%			-2%				8%
Storage Length (ft)	100		0	150		0	75		0	150		400
Storage Lanes	1		0	1		0	1		0	1		1
Taper Length (ft)	25			25			25			25		
Lane Util. Factor	1.00	1.00	1.00	1.00	1.00	1.00	1.00	0.95	0.95	1.00	0.95	1.00
Ped Bike Factor	0.97	0.99		0.96	0.98		0.94	0.95				0.73
Frt		0.977			0.969			0.979				0.850
Flt Protected	0.950			0.950			0.950			0.950		
Satd. Flow (prot)	1426	1612	0	1585	1587	0	1420	2741	0	1514	2725	1310
Flt Permitted	0.126			0.542			0.350			0.236		
Satd. Flow (perm)	184	1612	0	871	1587	0	490	2741	0	376	2725	952
Right Turn on Red			No			No			No			No
Satd. Flow (RTOR)												
Link Speed (mph)		20			20			25			25	
Link Distance (ft)		757			461			353			476	
Travel Time (s)		25.8			15.7			9.6			13.0	
Confl. Peds. (#/hr)	49		36	36		49	59		83	83		59
Peak Hour Factor	0.88	0.88	0.88	0.94	0.94	0.94	0.83	0.83	0.83	0.82	0.82	0.82
Heavy Vehicles (%)	2%	2%	2%	2%	2%	2%	4%	4%	4%	3%	3%	3%
Adj. Flow (vph)	264	313	56	124	259	67	63	719	116	83	628	338
Shared Lane Traffic (%)												
Lane Group Flow (vph)	264	369	0	124	326	0	63	835	0	83	628	338
Turn Type	pm+pt	NA		Perm	NA		pm+pt	NA		pm+pt	NA	pm+ov
Protected Phases	7	4			8		5	2		1	6	7
Permitted Phases	4			8			2			6		6
Detector Phase	7	4		8	8		5	2		1	6	7
Switch Phase												
Minimum Initial (s)	7.0	7.0		7.0	7.0		7.0	10.0		7.0	10.0	7.0
Minimum Split (s)	13.0	31.0		32.0	32.0		13.0	23.0		13.0	22.0	13.0
Total Split (s)	24.0	56.0		32.0	32.0		20.0	64.0		20.0	64.0	24.0
Total Split (%)	17.1%	40.0%		22.9%	22.9%		14.3%	45.7%		14.3%	45.7%	17.1%
Maximum Green (s)	18.2	50.0		26.0	26.0		14.2	58.2		14.9	58.2	18.2
Yellow Time (s)	3.0	3.2		3.2	3.2		3.0	3.3		3.0	3.3	3.0
All-Red Time (s)	2.8	2.8		2.8	2.8		2.8	2.5		2.1	2.5	2.8
Lost Time Adjust (s)	-0.8	-1.0		-1.0	-1.0		-1.0	-0.8		-0.1	-0.8	-0.8
Total Lost Time (s)	5.0	5.0		5.0	5.0		4.8	5.0		5.0	5.0	5.0
Lead/Lag	Lead			Lag	Lag		Lead	Lag		Lead	Lag	Lead
Lead-Lag Optimize?												
Vehicle Extension (s)	1.0	1.0		1.0	1.0		1.0	3.0		1.0	3.0	1.0
Recall Mode	None	None		None	None		None	C-Max		None	C-Max	None
Walk Time (s)		7.0		7.0	7.0			7.0			7.0	
Flash Dont Walk (s)		18.0		19.0	19.0			10.0			9.0	
Pedestrian Calls (#/hr)		0		0	0			0			0	
Act Effect Green (s)	51.0	51.0		27.0	27.0		74.7	66.1		74.8	68.3	87.3

Lanes, Volumes, Timings

2: NC 86 (N. Columbia St) & W. Rosemary Street/E. Rosemary Street

09/01/2020



Lane Group	EBL	EBT	EBR	WBL	WBT	WBR	NBL	NBT	NBR	SBL	SBT	SBR
Actuated g/C Ratio	0.36	0.36		0.19	0.19		0.53	0.47		0.53	0.49	0.62
v/c Ratio	1.12	0.63		0.74	1.07		0.20	0.65		0.31	0.47	0.53
Control Delay	129.8	44.5		78.3	120.9		5.5	7.7		16.0	20.8	12.7
Queue Delay	0.0	0.0		0.0	0.0		0.0	3.6		0.0	0.3	0.0
Total Delay	129.8	44.5		78.3	120.9		5.5	11.4		16.0	21.1	12.7
LOS	F	D		E	F		A	B		B	C	B
Approach Delay		80.1			109.2			11.0			18.0	
Approach LOS		F			F			B			B	
Queue Length 50th (ft)	~238	298		104	~330		7	51		29	126	73
Queue Length 95th (ft)	#399	412		#210	#526		m7	m51		43	144	97
Internal Link Dist (ft)		677			381			273			396	
Turn Bay Length (ft)	100			150			75			150		400
Base Capacity (vph)	235	587		167	306		378	1294		334	1330	642
Starvation Cap Reductn	0	0		0	0		0	358		0	226	7
Spillback Cap Reductn	0	0		0	0		0	0		0	73	0
Storage Cap Reductn	0	0		0	0		0	0		0	0	0
Reduced v/c Ratio	1.12	0.63		0.74	1.07		0.17	0.89		0.25	0.57	0.53

Intersection Summary

Area Type: CBD
 Cycle Length: 140
 Actuated Cycle Length: 140
 Offset: 62 (44%), Referenced to phase 2:NBTL and 6:SBTL, Start of Green
 Natural Cycle: 85
 Control Type: Actuated-Coordinated
 Maximum v/c Ratio: 1.12
 Intersection Signal Delay: 42.4 Intersection LOS: D
 Intersection Capacity Utilization 80.5% ICU Level of Service D
 Analysis Period (min) 15
 ~ Volume exceeds capacity, queue is theoretically infinite.
 Queue shown is maximum after two cycles.
 # 95th percentile volume exceeds capacity, queue may be longer.
 Queue shown is maximum after two cycles.
 m Volume for 95th percentile queue is metered by upstream signal.

Splits and Phases: 2: NC 86 (N. Columbia St) & W. Rosemary Street/E. Rosemary Street

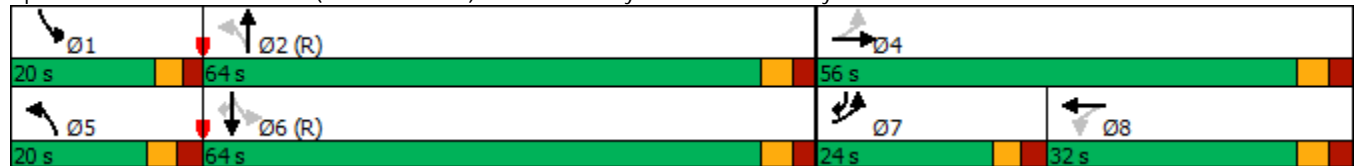

Lanes, Volumes, Timings
6: Henderson Street & E. Rosemary Street

09/01/2020



Lane Group	EBL	EBT	EBR	WBL	WBT	WBR	NBL	NBT	NBR	SBL	SBT	SBR
Lane Configurations												
Traffic Volume (vph)	43	294	155	12	201	58	67	24	5	23	57	10
Future Volume (vph)	43	294	155	12	201	58	67	24	5	23	57	10
Ideal Flow (vphpl)	1900	1900	1900	1900	1900	1900	1900	1900	1900	1900	1900	1900
Grade (%)		0%			0%			0%			3%	
Storage Length (ft)	85		0	0		0	0		0	0		0
Storage Lanes	1		0	0		0	0		0	0		0
Taper Length (ft)	25			25			25			25		
Lane Util. Factor	1.00	1.00	1.00	1.00	1.00	1.00	1.00	1.00	1.00	1.00	1.00	1.00
Ped Bike Factor	0.98	0.96			0.99			0.88			0.95	
Frt		0.948			0.971			0.993			0.985	
Flt Protected	0.950				0.998			0.966			0.987	
Satd. Flow (prot)	1593	1520	0	0	1603	0	0	1596	0	0	1566	0
Flt Permitted	0.613				0.977			0.757			0.908	
Satd. Flow (perm)	1006	1520	0	0	1569	0	0	1104	0	0	1401	0
Right Turn on Red			No			No			No			No
Satd. Flow (RTOR)												
Link Speed (mph)		20			20			20			20	
Link Distance (ft)		234			1195			366			450	
Travel Time (s)		8.0			40.7			12.5			15.3	
Confl. Peds. (#/hr)	14		34	34		14	73		51	51		73
Peak Hour Factor	0.90	0.90	0.90	0.93	0.93	0.93	0.67	0.67	0.67	0.79	0.79	0.79
Adj. Flow (vph)	48	327	172	13	216	62	100	36	7	29	72	13
Shared Lane Traffic (%)												
Lane Group Flow (vph)	48	499	0	0	291	0	0	143	0	0	114	0
Turn Type	Perm	NA		Perm	NA		Perm	NA		Perm	NA	
Protected Phases		2			2			4			4	
Permitted Phases	2			2			4			4		
Detector Phase	2	2		2	2		4	4		4	4	
Switch Phase												
Minimum Initial (s)	11.0	11.0		11.0	11.0		8.0	8.0		8.0	8.0	
Minimum Split (s)	15.9	15.9		15.9	15.9		17.8	17.8		17.8	17.8	
Total Split (s)	32.0	32.0		32.0	32.0		38.0	38.0		38.0	38.0	
Total Split (%)	45.7%	45.7%		45.7%	45.7%		54.3%	54.3%		54.3%	54.3%	
Maximum Green (s)	27.1	27.1		27.1	27.1		33.2	33.2		33.2	33.2	
Yellow Time (s)	3.3	3.3		3.3	3.3		3.3	3.3		3.3	3.3	
All-Red Time (s)	1.6	1.6		1.6	1.6		1.5	1.5		1.5	1.5	
Lost Time Adjust (s)	0.1	0.0			0.1			0.2			0.2	
Total Lost Time (s)	5.0	4.9			5.0			5.0			5.0	
Lead/Lag												
Lead-Lag Optimize?												
Vehicle Extension (s)	2.0	2.0		2.0	2.0		2.0	2.0		2.0	2.0	
Recall Mode	C-Max	C-Max		C-Max	C-Max		None	None		None	None	
Walk Time (s)	4.0	4.0		4.0	4.0		4.0	4.0		4.0	4.0	
Flash Dont Walk (s)	7.0	7.0		7.0	7.0		9.0	9.0		9.0	9.0	
Pedestrian Calls (#/hr)	0	0		0	0		0	0		0	0	
Act Effct Green (s)	46.0	46.1			46.0			14.0			14.0	
Actuated g/C Ratio	0.66	0.66			0.66			0.20			0.20	
v/c Ratio	0.07	0.50			0.28			0.65			0.41	

Lanes, Volumes, Timings
 6: Henderson Street & E. Rosemary Street

09/01/2020



Lane Group	EBL	EBT	EBR	WBL	WBT	WBR	NBL	NBT	NBR	SBL	SBT	SBR
Control Delay	6.7	8.6			5.9			29.3			27.0	
Queue Delay	0.0	0.0			0.0			0.0			0.0	
Total Delay	6.7	8.6			5.9			29.3			27.0	
LOS	A	A			A			C			C	
Approach Delay		8.5			5.9			29.3			27.0	
Approach LOS		A			A			C			C	
Queue Length 50th (ft)	7	86			58			53			44	
Queue Length 95th (ft)	m22	206			118			40			65	
Internal Link Dist (ft)		154			1115			286			370	
Turn Bay Length (ft)	85											
Base Capacity (vph)	660	1000			1030			520			660	
Starvation Cap Reductn	0	0			0			0			0	
Spillback Cap Reductn	0	0			0			0			0	
Storage Cap Reductn	0	0			0			0			0	
Reduced v/c Ratio	0.07	0.50			0.28			0.28			0.17	

Intersection Summary

Area Type: CBD
 Cycle Length: 70
 Actuated Cycle Length: 70
 Offset: 14 (20%), Referenced to phase 2:EBWB, Start of Green
 Natural Cycle: 50
 Control Type: Actuated-Coordinated
 Maximum v/c Ratio: 0.65
 Intersection Signal Delay: 12.4
 Intersection LOS: B
 Intersection Capacity Utilization 49.7%
 ICU Level of Service A
 Analysis Period (min) 15
 m Volume for 95th percentile queue is metered by upstream signal.

Splits and Phases: 6: Henderson Street & E. Rosemary Street

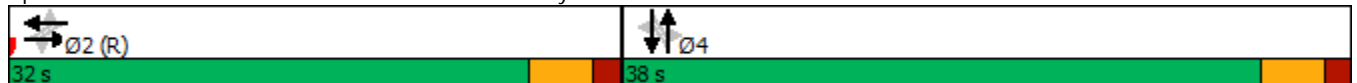

Lanes, Volumes, Timings
 7: Hillsborough Street & E. Rosemary Street

09/01/2020



Lane Group	EBL	EBT	EBR	WBL	WBT	WBR	NBL	NBT	NBR	SBL	SBT	SBR
Lane Configurations		↕			↕		↗	↘		↗	↘	
Traffic Volume (vph)	44	136	79	10	100	57	167	298	23	37	205	28
Future Volume (vph)	44	136	79	10	100	57	167	298	23	37	205	28
Ideal Flow (vphpl)	1900	1900	1900	1900	1900	1900	1900	1900	1900	1900	1900	1900
Storage Length (ft)	0		0	0		0	100		0	100		0
Storage Lanes	0		0	0		0	1		0	1		0
Taper Length (ft)	25			25			25			25		
Lane Util. Factor	1.00	1.00	1.00	1.00	1.00	1.00	1.00	1.00	1.00	1.00	1.00	1.00
Ped Bike Factor		0.98			0.97		0.92	1.00		0.98	0.98	
Frt		0.959			0.954			0.989			0.982	
Flt Protected		0.992			0.997		0.950			0.950		
Satd. Flow (prot)	0	1744	0	0	1713	0	1770	1836	0	1770	1786	0
Flt Permitted		0.911			0.976		0.497			0.552		
Satd. Flow (perm)	0	1588	0	0	1675	0	852	1836	0	1008	1786	0
Right Turn on Red			No			No			No			No
Satd. Flow (RTOR)												
Link Speed (mph)		20			20			25			25	
Link Distance (ft)		1195			527			363			726	
Travel Time (s)		40.7			18.0			9.9			19.8	
Confl. Peds. (#/hr)	27		14	14		27	52		9	9		52
Peak Hour Factor	0.86	0.86	0.86	0.79	0.79	0.79	0.92	0.92	0.92	0.96	0.96	0.96
Adj. Flow (vph)	51	158	92	13	127	72	182	324	25	39	214	29
Shared Lane Traffic (%)												
Lane Group Flow (vph)	0	301	0	0	212	0	182	349	0	39	243	0
Turn Type	Perm	NA		Perm	NA		pm+pt	NA		Perm	NA	
Protected Phases		4			8		5	2			6	
Permitted Phases	4			8			2			6		
Detector Phase	4	4		8	8		5	2		6	6	
Switch Phase												
Minimum Initial (s)	7.0	7.0		7.0	7.0		7.0	10.0		10.0	10.0	
Minimum Split (s)	20.0	20.0		17.0	17.0		12.0	15.0		15.0	15.0	
Total Split (s)	30.0	30.0		30.0	30.0		14.0	40.0		26.0	26.0	
Total Split (%)	42.9%	42.9%		42.9%	42.9%		20.0%	57.1%		37.1%	37.1%	
Maximum Green (s)	25.1	25.1		25.0	25.0		9.2	35.2		21.2	21.2	
Yellow Time (s)	3.0	3.0		3.3	3.3		3.0	3.3		3.1	3.1	
All-Red Time (s)	1.9	1.9		1.7	1.7		1.8	1.5		1.7	1.7	
Lost Time Adjust (s)		0.1			0.0		0.2	0.2		0.2	0.2	
Total Lost Time (s)		5.0			5.0		5.0	5.0		5.0	5.0	
Lead/Lag							Lead			Lag	Lag	
Lead-Lag Optimize?												
Vehicle Extension (s)	2.0	2.0		2.0	2.0		2.0	2.0		2.0	2.0	
Recall Mode	None	None		None	None		None	C-Max		C-Max	C-Max	
Walk Time (s)	4.0	4.0		4.0	4.0			4.0		4.0	4.0	
Flash Dont Walk (s)	11.0	11.0		8.0	8.0			6.0		6.0	6.0	
Pedestrian Calls (#/hr)	0	0		0	0			0		0	0	
Act Effct Green (s)		17.6			17.6		42.4	42.4		29.6	29.6	
Actuated g/C Ratio		0.25			0.25		0.61	0.61		0.42	0.42	
v/c Ratio		0.76			0.50		0.29	0.31		0.09	0.32	
Control Delay		30.0			25.6		6.9	7.3		16.2	17.2	

Lanes, Volumes, Timings
 7: Hillsborough Street & E. Rosemary Street

09/01/2020



Lane Group	EBL	EBT	EBR	WBL	WBT	WBR	NBL	NBT	NBR	SBL	SBT	SBR
Queue Delay		0.0			0.0		0.0	0.3		0.0	0.0	
Total Delay		30.0			25.6		6.9	7.6		16.2	17.2	
LOS		C			C		A	A		B	B	
Approach Delay		30.0			25.6			7.3			17.0	
Approach LOS		C			C			A			B	
Queue Length 50th (ft)		118			78		35	85		10	66	
Queue Length 95th (ft)		121			101		71	152		34	146	
Internal Link Dist (ft)		1115			447			283			646	
Turn Bay Length (ft)							100			100		
Base Capacity (vph)		567			598		635	1112		426	754	
Starvation Cap Reductn		0			0		0	319		0	0	
Spillback Cap Reductn		0			0		0	0		0	0	
Storage Cap Reductn		0			0		0	0		0	0	
Reduced v/c Ratio		0.53			0.35		0.29	0.44		0.09	0.32	

Intersection Summary

Area Type:	Other
Cycle Length:	70
Actuated Cycle Length:	70
Offset:	32 (46%), Referenced to phase 2:NBTL and 6:SBTL, Start of Green
Natural Cycle:	50
Control Type:	Actuated-Coordinated
Maximum v/c Ratio:	0.76
Intersection Signal Delay:	17.5
Intersection LOS:	B
Intersection Capacity Utilization	65.9%
ICU Level of Service	C
Analysis Period (min)	15

Splits and Phases: 7: Hillsborough Street & E. Rosemary Street

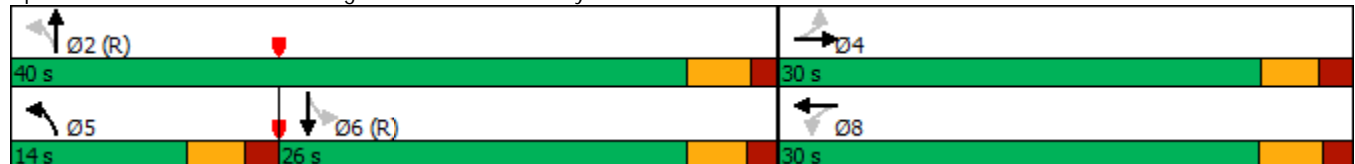

Lanes, Volumes, Timings

8: Carolina Square Driveway/Church Street & W. Franklin Street

09/01/2020



Lane Group	EBL	EBT	EBR	WBL	WBT	WBR	NBL	NBT	NBR	SBL	SBT	SBR
Lane Configurations												
Traffic Volume (vph)	67	468	18	41	577	73	24	48	40	74	60	81
Future Volume (vph)	67	468	18	41	577	73	24	48	40	74	60	81
Ideal Flow (vphpl)	1900	1900	1900	1900	1900	1900	1900	1900	1900	1900	1900	1900
Lane Width (ft)	10	10	16	10	10	10	12	12	12	12	12	12
Grade (%)		2%			-2%			-4%				-3%
Storage Length (ft)	150		0	200		0	0		100	0		0
Storage Lanes	1		0	1		0	0		1	0		0
Taper Length (ft)	25			25			25			25		
Lane Util. Factor	1.00	1.00	1.00	1.00	1.00	1.00	1.00	1.00	1.00	1.00	1.00	1.00
Ped Bike Factor		0.99		0.88	0.96			0.94	0.88		0.86	
Frt		0.994			0.983				0.850		0.949	
Flt Protected	0.950			0.950				0.983			0.983	
Satd. Flow (prot)	1457	1504	0	1501	1493	0	0	1681	1454	0	1404	0
Flt Permitted	0.274			0.387				0.865			0.855	
Satd. Flow (perm)	420	1504	0	538	1493	0	0	1387	1282	0	1184	0
Right Turn on Red			No			No			No			No
Satd. Flow (RTOR)												
Link Speed (mph)		20			20			20			25	
Link Distance (ft)		993			294			285			379	
Travel Time (s)		33.9			10.0			9.7			10.3	
Confl. Peds. (#/hr)	124		164	164		124	175		63	63		175
Peak Hour Factor	0.91	0.91	0.91	0.93	0.93	0.93	0.81	0.81	0.81	0.91	0.91	0.91
Heavy Vehicles (%)	3%	3%	3%	2%	2%	2%	2%	2%	2%	2%	2%	2%
Adj. Flow (vph)	74	514	20	44	620	78	30	59	49	81	66	89
Shared Lane Traffic (%)												
Lane Group Flow (vph)	74	534	0	44	698	0	0	89	49	0	236	0
Turn Type	Perm	NA		Perm	NA		Perm	NA	Perm	Perm	NA	
Protected Phases		2			6			8				4
Permitted Phases	2			6			8		8	4		
Detector Phase	2	2		6	6		8	8	8	4	4	
Switch Phase												
Minimum Initial (s)	10.0	10.0		10.0	10.0		7.0	7.0	7.0	7.0	7.0	
Minimum Split (s)	22.0	22.0		19.0	19.0		29.0	29.0	29.0	27.0	27.0	
Total Split (s)	41.0	41.0		41.0	41.0		29.0	29.0	29.0	29.0	29.0	
Total Split (%)	58.6%	58.6%		58.6%	58.6%		41.4%	41.4%	41.4%	41.4%	41.4%	
Maximum Green (s)	35.4	35.4		35.4	35.4		22.7	22.7	22.7	23.0	23.0	
Yellow Time (s)	3.3	3.3		3.3	3.3		3.1	3.1	3.1	3.4	3.4	
All-Red Time (s)	2.3	2.3		2.3	2.3		3.2	3.2	3.2	2.6	2.6	
Lost Time Adjust (s)	-0.6	-0.6		-0.6	-0.6		-1.3	-1.3	-1.3		-1.0	
Total Lost Time (s)	5.0	5.0		5.0	5.0		5.0	5.0	5.0		5.0	
Lead/Lag												
Lead-Lag Optimize?												
Vehicle Extension (s)	3.0	3.0		3.0	3.0		2.0	2.0	2.0	2.0	2.0	
Recall Mode	C-Max	C-Max		C-Max	C-Max		None	None	None	None	None	
Walk Time (s)	7.0	7.0		7.0	7.0		7.0	7.0	7.0	7.0	7.0	
Flash Dont Walk (s)	9.0	9.0		6.0	6.0		15.0	15.0	15.0	14.0	14.0	
Pedestrian Calls (#/hr)	0	0		0	0		0	0	0	0	0	
Act Effect Green (s)	41.5	41.5		41.5	41.5		18.5	18.5	18.5		18.5	

Lanes, Volumes, Timings

8: Carolina Square Driveway/Church Street & W. Franklin Street

09/01/2020



Lane Group	EBL	EBT	EBR	WBL	WBT	WBR	NBL	NBT	NBR	SBL	SBT	SBR
Actuated g/C Ratio	0.59	0.59		0.59	0.59			0.26	0.26		0.26	
v/c Ratio	0.30	0.60		0.14	0.79			0.24	0.14		0.76	
Control Delay	13.2	14.0		10.1	18.2			20.1	18.6		36.2	
Queue Delay	0.0	0.0		0.0	0.0			0.0	0.0		0.0	
Total Delay	13.2	14.0		10.1	18.2			20.1	18.6		36.2	
LOS	B	B		B	B			C	B		D	
Approach Delay		13.9			17.7			19.5			36.2	
Approach LOS		B			B			B			D	
Queue Length 50th (ft)	14	134		15	331			30	16		107	
Queue Length 95th (ft)	49	274		m18	m329			51	32		119	
Internal Link Dist (ft)		913			214			205			299	
Turn Bay Length (ft)	150			200					100			
Base Capacity (vph)	249	892		319	885			475	439		405	
Starvation Cap Reductn	0	0		0	0			0	0		0	
Spillback Cap Reductn	0	0		0	0			0	0		0	
Storage Cap Reductn	0	0		0	0			0	0		0	
Reduced v/c Ratio	0.30	0.60		0.14	0.79			0.19	0.11		0.58	

Intersection Summary

Area Type: CBD
 Cycle Length: 70
 Actuated Cycle Length: 70
 Offset: 66 (94%), Referenced to phase 2:EBTL and 6:WBTL, Start of Green
 Natural Cycle: 70
 Control Type: Actuated-Coordinated
 Maximum v/c Ratio: 0.79
 Intersection Signal Delay: 19.0 Intersection LOS: B
 Intersection Capacity Utilization 83.3% ICU Level of Service E
 Analysis Period (min) 15
 m Volume for 95th percentile queue is metered by upstream signal.

Splits and Phases: 8: Carolina Square Driveway/Church Street & W. Franklin Street

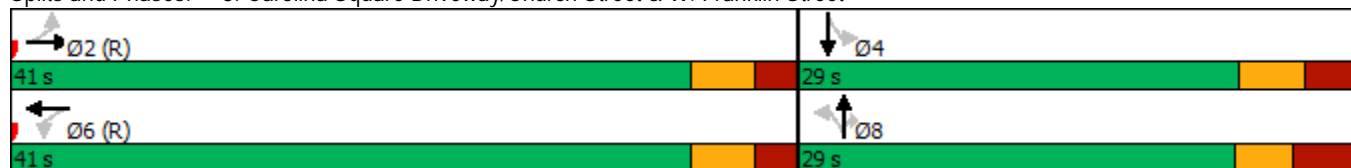

Lanes, Volumes, Timings

9: NC 86 (S. Columbia St)/NC 86 (N. Columbia St) & W. Franklin Street/E. Franklin Street 09/01/2020



Lane Group	EBL	EBT	EBR	WBL	WBT	WBR	NBL	NBT	NBR	SBL	SBT	SBR
Lane Configurations												
Traffic Volume (vph)	180	434	76	102	519	67	65	572	113	74	442	126
Future Volume (vph)	180	434	76	102	519	67	65	572	113	74	442	126
Ideal Flow (vphpl)	1900	1900	1900	1900	1900	1900	1900	1900	1900	1900	1900	1900
Lane Width (ft)	9	12	13	10	10	13	9	10	10	9	9	11
Grade (%)		3%			1%			-2%			3%	
Storage Length (ft)	250		0	125		0	475		0	125		0
Storage Lanes	1		0	1		1	1		0	1		0
Taper Length (ft)	25			25			25			25		
Lane Util. Factor	1.00	0.95	0.95	1.00	1.00	1.00	1.00	0.95	0.95	1.00	0.95	0.95
Ped Bike Factor	0.87	0.96		0.87		0.68	0.91	0.96		0.93	0.95	
Frt		0.978				0.850		0.975			0.967	
Flt Protected	0.950			0.950			0.950			0.950		
Satd. Flow (prot)	1412	2933	0	1479	1557	1465	1380	2692	0	1385	2542	0
Flt Permitted	0.950			0.950			0.950			0.950		
Satd. Flow (perm)	1224	2933	0	1289	1557	997	1253	2692	0	1286	2542	0
Right Turn on Red			No			No			No			No
Satd. Flow (RTOR)												
Link Speed (mph)		20			20			25			25	
Link Distance (ft)		461			941			981			353	
Travel Time (s)		15.7			32.1			26.8			9.6	
Confl. Peds. (#/hr)	193		152	152		193	67		108	108		67
Peak Hour Factor	0.87	0.87	0.87	0.84	0.84	0.84	0.90	0.90	0.90	0.94	0.94	0.94
Heavy Vehicles (%)	2%	2%	2%	2%	2%	2%	7%	7%	7%	4%	4%	4%
Adj. Flow (vph)	207	499	87	121	618	80	72	636	126	79	470	134
Shared Lane Traffic (%)												
Lane Group Flow (vph)	207	586	0	121	618	80	72	762	0	79	604	0
Turn Type	Prot	NA		Prot	NA	pm+ov	Prot	NA		Prot	NA	
Protected Phases	5	2		1	6	7	3	8		7	4	
Permitted Phases						6						
Detector Phase	5	2		1	6	7	3	8		7	4	
Switch Phase												
Minimum Initial (s)	7.0	10.0		7.0	10.0	7.0	7.0	7.0		7.0	7.0	
Minimum Split (s)	15.0	28.2		15.0	28.2	15.0	15.0	28.0		15.0	28.1	
Total Split (s)	22.0	36.0		43.0	57.0	15.0	21.0	46.0		15.0	40.0	
Total Split (%)	15.7%	25.7%		30.7%	40.7%	10.7%	15.0%	32.9%		10.7%	28.6%	
Maximum Green (s)	16.6	29.8		37.1	50.8	9.1	15.1	40.1		9.1	34.3	
Yellow Time (s)	3.0	3.0		3.0	3.0	3.0	3.0	3.3		3.0	3.1	
All-Red Time (s)	2.4	3.2		2.9	3.2	2.9	2.9	2.6		2.9	2.6	
Lost Time Adjust (s)	-0.4	-1.2		-0.9	-1.2	-2.0	-0.9	-0.9		-0.9	-0.7	
Total Lost Time (s)	5.0	5.0		5.0	5.0	3.9	5.0	5.0		5.0	5.0	
Lead/Lag	Lead	Lag		Lead	Lag	Lead	Lead	Lag		Lead	Lag	
Lead-Lag Optimize?	Yes	Yes		Yes	Yes	Yes	Yes	Yes		Yes	Yes	
Vehicle Extension (s)	1.0	3.0		1.0	3.0	1.0	1.0	2.0		1.0	2.0	
Recall Mode	None	C-Max		None	C-Max	None	None	Ped		None	Ped	
Walk Time (s)		7.0			7.0			7.0			7.0	
Flash Dont Walk (s)		15.0			15.0			15.0			15.0	
Pedestrian Calls (#/hr)		0			0			0			0	
Act Effect Green (s)	17.6	53.7		15.9	52.0	63.8	11.7	40.8		9.6	41.2	

Lanes, Volumes, Timings

9: NC 86 (S. Columbia St)/NC 86 (N. Columbia St) & W. Franklin Street/E. Franklin Street 09/01/2020



Lane Group	EBL	EBT	EBR	WBL	WBT	WBR	NBL	NBT	NBR	SBL	SBT	SBR
Actuated g/C Ratio	0.13	0.38		0.11	0.37	0.46	0.08	0.29		0.07	0.29	
v/c Ratio	1.17	0.52		0.72	1.07	0.16	0.63	0.97		0.84	0.81	
Control Delay	166.2	36.7		93.2	91.8	21.7	102.0	18.6		125.7	38.4	
Queue Delay	0.0	0.0		0.0	0.0	0.0	0.0	0.0		0.0	1.1	
Total Delay	166.2	36.7		93.2	91.8	21.7	102.0	18.6		125.7	39.6	
LOS	F	D		F	F	C	F	B		F	D	
Approach Delay		70.5			85.1			25.8			49.5	
Approach LOS		E			F			C			D	
Queue Length 50th (ft)	~232	203		113	-639	31	69	108		75	133	
Queue Length 95th (ft)	#374	301		169	#785	m57	m61	m61		m#157	#397	
Internal Link Dist (ft)		381			861			901			273	
Turn Bay Length (ft)	250			125			475			125		
Base Capacity (vph)	177	1125		401	578	494	157	788		98	748	
Starvation Cap Reductn	0	0		0	0	0	0	0		0	37	
Spillback Cap Reductn	0	0		0	0	0	0	0		0	0	
Storage Cap Reductn	0	0		0	0	0	0	0		0	0	
Reduced v/c Ratio	1.17	0.52		0.30	1.07	0.16	0.46	0.97		0.81	0.85	

Intersection Summary

Area Type: CBD
 Cycle Length: 140
 Actuated Cycle Length: 140
 Offset: 0 (0%), Referenced to phase 2:EBT and 6:WBT, Start of Green
 Natural Cycle: 150
 Control Type: Actuated-Coordinated
 Maximum v/c Ratio: 1.17
 Intersection Signal Delay: 57.8 Intersection LOS: E
 Intersection Capacity Utilization 86.5% ICU Level of Service E
 Analysis Period (min) 15
 ~ Volume exceeds capacity, queue is theoretically infinite.
 Queue shown is maximum after two cycles.
 # 95th percentile volume exceeds capacity, queue may be longer.
 Queue shown is maximum after two cycles.
 m Volume for 95th percentile queue is metered by upstream signal.

Splits and Phases: 9: NC 86 (S. Columbia St)/NC 86 (N. Columbia St) & W. Franklin Street/E. Franklin Street



Lanes, Volumes, Timings
 10: E. Franklin Street & Henderson Street

09/01/2020



Lane Group	EBL	EBT	WBT	WBR	SBL	SBR
Lane Configurations		↕↕	↕↔		↔↕	
Traffic Volume (vph)	34	607	654	71	168	58
Future Volume (vph)	34	607	654	71	168	58
Ideal Flow (vphpl)	1900	1900	1900	1900	1900	1900
Lane Width (ft)	10	13	10	10	11	11
Grade (%)		-2%	2%		3%	
Lane Util. Factor	0.95	0.95	0.95	0.95	1.00	1.00
Ped Bike Factor		1.00	0.97		0.87	
Frt			0.985		0.965	
Flt Protected		0.997			0.964	
Satd. Flow (prot)	0	3282	2820	0	1398	0
Flt Permitted		0.884			0.964	
Satd. Flow (perm)	0	2898	2820	0	1297	0
Right Turn on Red				No		No
Satd. Flow (RTOR)						
Link Speed (mph)		20	20		20	
Link Distance (ft)		941	1200		366	
Travel Time (s)		32.1	40.9		12.5	
Confl. Peds. (#/hr)	114			114	88	198
Peak Hour Factor	0.90	0.90	0.93	0.93	0.83	0.83
Heavy Vehicles (%)	3%	3%	2%	2%	2%	2%
Parking (#/hr)						0
Adj. Flow (vph)	38	674	703	76	202	70
Shared Lane Traffic (%)						
Lane Group Flow (vph)	0	712	779	0	272	0
Turn Type	Perm	NA	NA		Prot	
Protected Phases		2	6		4	
Permitted Phases	2					
Detector Phase	2	2	6		4	
Switch Phase						
Minimum Initial (s)	10.0	10.0	10.0		7.0	
Minimum Split (s)	16.2	16.2	21.1		24.1	
Total Split (s)	43.0	43.0	43.0		27.0	
Total Split (%)	61.4%	61.4%	61.4%		38.6%	
Maximum Green (s)	36.8	36.8	36.9		21.9	
Yellow Time (s)	3.0	3.0	3.0		3.0	
All-Red Time (s)	3.2	3.2	3.1		2.1	
Lost Time Adjust (s)		-1.2	-1.1		-0.1	
Total Lost Time (s)		5.0	5.0		5.0	
Lead/Lag						
Lead-Lag Optimize?						
Vehicle Extension (s)	2.0	2.0	2.0		1.0	
Recall Mode	C-Max	C-Max	C-Max		None	
Walk Time (s)			7.0		7.0	
Flash Dont Walk (s)			8.0		12.0	
Pedestrian Calls (#/hr)			0		0	
Act Effct Green (s)		43.3	43.3		16.7	
Actuated g/C Ratio		0.62	0.62		0.24	
v/c Ratio		0.40	0.45		0.82	

Lanes, Volumes, Timings
 10: E. Franklin Street & Henderson Street

09/01/2020



Lane Group	EBL	EBT	WBT	WBR	SBL	SBR
Control Delay		9.4	6.0		42.3	
Queue Delay		0.0	0.0		0.0	
Total Delay		9.4	6.0		42.3	
LOS		A	A		D	
Approach Delay		9.4	6.0		42.3	
Approach LOS		A	A		D	
Queue Length 50th (ft)		194	74		114	
Queue Length 95th (ft)		m164	161		145	
Internal Link Dist (ft)		861	1120		286	
Turn Bay Length (ft)						
Base Capacity (vph)		1793	1745		439	
Starvation Cap Reductn		0	0		0	
Spillback Cap Reductn		0	0		0	
Storage Cap Reductn		0	0		0	
Reduced v/c Ratio		0.40	0.45		0.62	

Intersection Summary

Area Type:	CBD
Cycle Length:	70
Actuated Cycle Length:	70
Offset:	27 (39%), Referenced to phase 2:EBTL and 6:WBT, Start of Green
Natural Cycle:	50
Control Type:	Actuated-Coordinated
Maximum v/c Ratio:	0.82
Intersection Signal Delay:	13.0
Intersection LOS:	B
Intersection Capacity Utilization:	71.4%
ICU Level of Service:	C
Analysis Period (min):	15
m Volume for 95th percentile queue is metered by upstream signal.	

Splits and Phases: 10: E. Franklin Street & Henderson Street

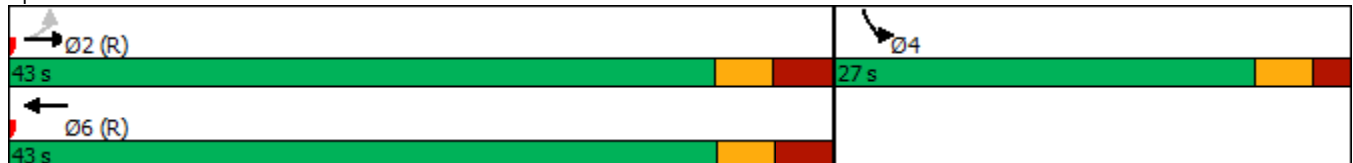

Lanes, Volumes, Timings

11: Raleigh Street/Hillsborough Street & E. Franklin Street

09/01/2020



Lane Group	EBL	EBT	EBR	WBL	WBT	WBR	NBL	NBT	NBR	SBL	SBT	SBR
Lane Configurations												
Traffic Volume (vph)	52	555	239	63	671	244	52	200	23	65	208	13
Future Volume (vph)	52	555	239	63	671	244	52	200	23	65	208	13
Ideal Flow (vphpl)	1900	1900	1900	1900	1900	1900	1900	1900	1900	1900	1900	1900
Lane Width (ft)	9	9	10	9	10	11	12	12	12	10	10	10
Grade (%)		1%			-2%			1%			1%	
Storage Length (ft)	75		0	75		0	0		0	100		0
Storage Lanes	1		0	1		0	0		0	1		0
Taper Length (ft)	25			25			25			25		
Lane Util. Factor	1.00	0.95	0.95	1.00	0.95	0.95	1.00	1.00	1.00	1.00	1.00	1.00
Ped Bike Factor	1.00	0.99		1.00	0.99			0.99		0.99	0.99	
Frt		0.955			0.960			0.989			0.991	
Flt Protected	0.950			0.950				0.991		0.950		
Satd. Flow (prot)	1585	2995	0	1609	3173	0	0	1813	0	1643	1702	0
Flt Permitted	0.244			0.286				0.697		0.406		
Satd. Flow (perm)	406	2995	0	482	3173	0	0	1263	0	698	1702	0
Right Turn on Red			No			No			No			No
Satd. Flow (RTOR)												
Link Speed (mph)		20			30			25			25	
Link Distance (ft)		1200			1013			995			363	
Travel Time (s)		40.9			23.0			27.1			9.9	
Confl. Peds. (#/hr)	16		16	16		16	58		7	7		58
Peak Hour Factor	0.91	0.91	0.91	0.92	0.92	0.92	0.93	0.93	0.93	0.88	0.88	0.88
Adj. Flow (vph)	57	610	263	68	729	265	56	215	25	74	236	15
Shared Lane Traffic (%)												
Lane Group Flow (vph)	57	873	0	68	994	0	0	296	0	74	251	0
Turn Type	Perm	NA		Perm	NA		pm+pt	NA		D.Pm	NA	
Protected Phases		2			6		7	4			8	
Permitted Phases	2			6			4			4		
Detector Phase	2	2		6	6		7	4		4	8	
Switch Phase												
Minimum Initial (s)	10.0	10.0		10.0	10.0		7.0	7.0		7.0	7.0	
Minimum Split (s)	16.0	16.0		16.0	16.0		14.0	30.0		30.0	29.0	
Total Split (s)	79.0	79.0		79.0	79.0		14.0	61.0		61.0	47.0	
Total Split (%)	56.4%	56.4%		56.4%	56.4%		10.0%	43.6%		43.6%	33.6%	
Maximum Green (s)	73.7	73.7		73.7	73.7		7.8	54.6		54.6	40.6	
Yellow Time (s)	3.0	3.0		3.0	3.0		3.0	3.1		3.1	3.1	
All-Red Time (s)	2.3	2.3		2.3	2.3		3.2	3.3		3.3	3.3	
Lost Time Adjust (s)	-0.3	-0.3		-0.3	-0.3			-1.4		-1.4	-1.4	
Total Lost Time (s)	5.0	5.0		5.0	5.0			5.0		5.0	5.0	
Lead/Lag							Lead				Lag	
Lead-Lag Optimize?												
Vehicle Extension (s)	3.0	3.0		3.0	3.0		3.0	2.0		2.0	2.0	
Recall Mode	C-Max	C-Max		C-Max	C-Max		None	None		None	None	
Walk Time (s)								7.0		7.0	7.0	
Flash Dont Walk (s)								16.0		16.0	15.0	
Pedestrian Calls (#/hr)								0		0	0	
Act Effect Green (s)	93.0	93.0		93.0	93.0			37.0		37.0	37.0	
Actuated g/C Ratio	0.66	0.66		0.66	0.66			0.26		0.26	0.26	

Lanes, Volumes, Timings

11: Raleigh Street/Hillsborough Street & E. Franklin Street

09/01/2020

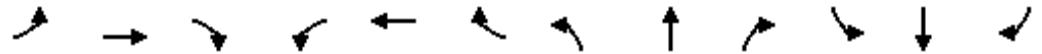

Lane Group	EBL	EBT	EBR	WBL	WBT	WBR	NBL	NBT	NBR	SBL	SBT	SBR
v/c Ratio	0.21	0.44		0.21	0.47			0.89		0.40	0.56	
Control Delay	6.6	5.6		13.5	13.5			76.2		42.1	43.1	
Queue Delay	0.0	0.0		0.0	0.0			0.0		0.0	1.1	
Total Delay	6.6	5.6		13.5	13.5			76.2		42.1	44.2	
LOS	A	A		B	B			E		D	D	
Approach Delay		5.6			13.5			76.2			43.7	
Approach LOS		A			B			E			D	
Queue Length 50th (ft)	8	74		23	218			260		53	179	
Queue Length 95th (ft)	m20	143		60	337			343		83	221	
Internal Link Dist (ft)		1120			933			915			283	
Turn Bay Length (ft)	75			75						100		
Base Capacity (vph)	269	1989		320	2107			505		279	526	
Starvation Cap Reductn	0	0		0	0			0		0	113	
Spillback Cap Reductn	0	0		0	0			0		0	0	
Storage Cap Reductn	0	0		0	0			0		0	0	
Reduced v/c Ratio	0.21	0.44		0.21	0.47			0.59		0.27	0.61	

Intersection Summary





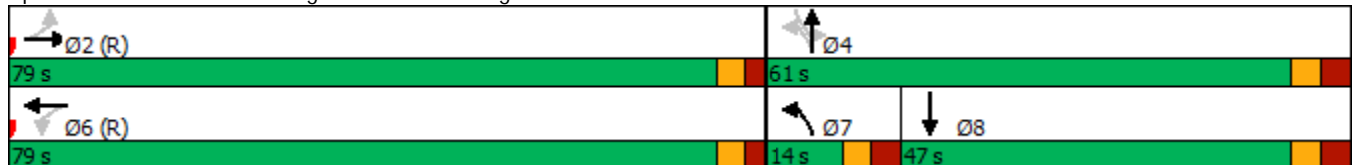













Area Type: Other
 Cycle Length: 140
 Actuated Cycle Length: 140
 Offset: 73 (52%), Referenced to phase 2:EBTL and 6:WBTL, Start of Green
 Natural Cycle: 70
 Control Type: Actuated-Coordinated
 Maximum v/c Ratio: 0.89
 Intersection Signal Delay: 21.6
 Intersection LOS: C
 Intersection Capacity Utilization 84.9%
 ICU Level of Service E
 Analysis Period (min) 15
 m Volume for 95th percentile queue is metered by upstream signal.

Splits and Phases: 11: Raleigh Street/Hillsborough Street & E. Franklin Street



Lanes, Volumes, Timings

13: NC 86 (N. Columbia St)/NC 86 (MLK Jr. Blvd) & North Street & N. Columbia Street 09/01/2020

												
Lane Group	WBL	WBR	WBR2	NBL	NBT	NBR	SBL	SBT	SBR	SEL2	SEL	SER
Lane Configurations												
Traffic Volume (vph)	24	21	148	49	826	23	54	737	6	4	5	101
Future Volume (vph)	24	21	148	49	826	23	54	737	6	4	5	101
Ideal Flow (vphpl)	1900	1900	1900	1900	1900	1900	1900	1900	1900	1900	1900	1900
Grade (%)	2%				-5%			5%			-3%	
Storage Length (ft)	0	50		150		0	70		0		0	0
Storage Lanes	1	1		1		0	1		0		1	0
Taper Length (ft)	25			25			25				25	
Lane Util. Factor	1.00	1.00	1.00	1.00	0.95	0.95	1.00	0.95	0.95	1.00	1.00	1.00
Ped Bike Factor				1.00	1.00		0.99	1.00			1.00	
Frt	0.931		0.850		0.996			0.999			0.875	
Flt Protected	0.974			0.950			0.950				0.996	
Satd. Flow (prot)	1672	0	1567	1796	3573	0	1709	3413	0	0	1601	0
Flt Permitted	0.974			0.310			0.250				0.996	
Satd. Flow (perm)	1672	0	1567	585	3573	0	447	3413	0	0	1598	0
Right Turn on Red			Yes			Yes			Yes			Yes
Satd. Flow (RTOR)			170		3			1			110	
Link Speed (mph)	20				35			35			25	
Link Distance (ft)	246				476			2108			715	
Travel Time (s)	8.4				9.3			41.1			19.5	
Confl. Peds. (#/hr)				7		32	32		7	8		
Peak Hour Factor	0.87	0.87	0.87	0.83	0.83	0.83	0.88	0.88	0.88	0.92	0.92	0.92
Heavy Vehicles (%)	2%	2%	2%	3%	3%	3%	3%	3%	3%	5%	5%	5%
Adj. Flow (vph)	28	24	170	59	995	28	61	838	7	4	5	110
Shared Lane Traffic (%)												
Lane Group Flow (vph)	52	0	170	59	1023	0	61	845	0	0	119	0
Turn Type	Prot		Perm	Perm	NA		Perm	NA		Prot	Prot	
Protected Phases	3				2			6		4	4	
Permitted Phases			3	2			6					
Detector Phase	3		3	2	2		6	6		4	4	
Switch Phase												
Minimum Initial (s)	7.0		7.0	10.0	10.0		10.0	10.0		7.0	7.0	
Minimum Split (s)	14.0		14.0	17.0	17.0		17.0	17.0		14.0	14.0	
Total Split (s)	35.0		35.0	82.0	82.0		82.0	82.0		23.0	23.0	
Total Split (%)	25.0%		25.0%	58.6%	58.6%		58.6%	58.6%		16.4%	16.4%	
Maximum Green (s)	28.0		28.0	75.0	75.0		75.0	75.0		16.0	16.0	
Yellow Time (s)	5.0		5.0	5.0	5.0		5.0	5.0		5.0	5.0	
All-Red Time (s)	2.0		2.0	2.0	2.0		2.0	2.0		2.0	2.0	
Lost Time Adjust (s)	-2.0		-2.0	-2.0	-2.0		-2.0	-2.0			-2.0	
Total Lost Time (s)	5.0		5.0	5.0	5.0		5.0	5.0			5.0	
Lead/Lag	Lead		Lead							Lag	Lag	
Lead-Lag Optimize?	Yes		Yes							Yes	Yes	
Vehicle Extension (s)	3.0		3.0	3.0	3.0		3.0	3.0		3.0	3.0	
Recall Mode	None		None	C-Max	C-Max		C-Max	C-Max		None	None	
Act Effct Green (s)	12.0		12.0	102.5	102.5		102.5	102.5			10.5	
Actuated g/C Ratio	0.09		0.09	0.73	0.73		0.73	0.73			0.08	
v/c Ratio	0.36		0.59	0.14	0.39		0.19	0.34			0.54	
Control Delay	66.8		16.8	3.2	3.0		8.5	7.5			21.8	
Queue Delay	0.0		0.0	0.0	0.3		0.0	0.0			0.0	

Lanes, Volumes, Timings

13: NC 86 (N. Columbia St)/NC 86 (MLK Jr. Blvd) & North Street & N. Columbia Street 09/01/2020



Lane Group	WBL	WBR	WBR2	NBL	NBT	NBR	SBL	SBT	SBR	SEL2	SEL	SER
Total Delay	66.8		16.8	3.2	3.3		8.5	7.5			21.8	
LOS	E		B	A	A		A	A			C	
Approach Delay	28.5				3.3			7.6			21.8	
Approach LOS	C				A			A			C	
Queue Length 50th (ft)	46		0	6	60		15	122			8	
Queue Length 95th (ft)	85		63	m9	m61		41	192			69	
Internal Link Dist (ft)	166				396			2028			635	
Turn Bay Length (ft)			50	150			70					
Base Capacity (vph)	358		469	428	2615		327	2497			301	
Starvation Cap Reductn	0		0	0	872		0	0			0	
Spillback Cap Reductn	0		0	0	0		0	0			0	
Storage Cap Reductn	0		0	0	0		0	0			0	
Reduced v/c Ratio	0.15		0.36	0.14	0.59		0.19	0.34			0.40	

Intersection Summary

Area Type: Other
 Cycle Length: 140
 Actuated Cycle Length: 140
 Offset: 77 (55%), Referenced to phase 2:NBTL and 6:SBTL, Start of Green
 Natural Cycle: 60
 Control Type: Actuated-Coordinated
 Maximum v/c Ratio: 0.59
 Intersection Signal Delay: 8.3
 Intersection LOS: A
 Intersection Capacity Utilization 61.2%
 ICU Level of Service B
 Analysis Period (min) 15
 m Volume for 95th percentile queue is metered by upstream signal.

Splits and Phases: 13: NC 86 (N. Columbia St)/NC 86 (MLK Jr. Blvd) & North Street & N. Columbia Street

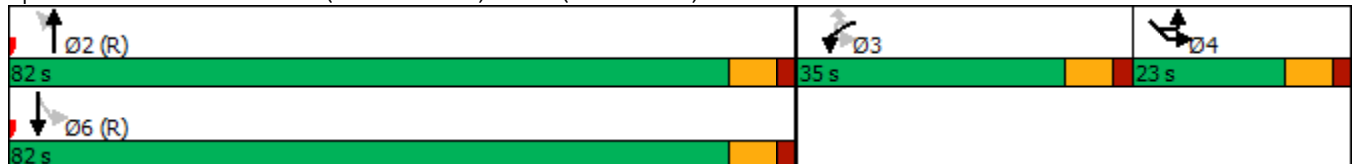

Lanes, Volumes, Timings

14: NC 86 (MLK Jr. Blvd) & Longview Street/Mill Creek Apts Driveway

09/01/2020



Lane Group	EBL	EBT	EBR	WBL	WBT	WBR	NBL	NBT	NBR	SBL	SBT	SBR
Lane Configurations		↕			↕		↗	↕↔		↗	↕↔	
Traffic Volume (vph)	97	2	18	34	1	8	14	955	13	11	672	78
Future Volume (vph)	97	2	18	34	1	8	14	955	13	11	672	78
Ideal Flow (vphpl)	1900	1900	1900	1900	1900	1900	1900	1900	1900	1900	1900	1900
Grade (%)		-6%			1%			2%			-4%	
Storage Length (ft)	0		0	0		0	225		0	250		0
Storage Lanes	0		0	0		0	1		0	1		0
Taper Length (ft)	25			25			25			25		
Lane Util. Factor	1.00	1.00	1.00	1.00	1.00	1.00	1.00	0.95	0.95	1.00	0.95	0.95
Ped Bike Factor		0.99			0.99		0.99	1.00		0.99	1.00	
Frt		0.979			0.974			0.998			0.984	
Flt Protected		0.960			0.962		0.950			0.950		
Satd. Flow (prot)	0	1795	0	0	1732	0	1735	3459	0	1787	3504	0
Flt Permitted		0.722			0.754		0.336			0.214		
Satd. Flow (perm)	0	1348	0	0	1341	0	610	3459	0	398	3504	0
Right Turn on Red			No			No			No			No
Satd. Flow (RTOR)												
Link Speed (mph)		25			20			35			35	
Link Distance (ft)		451			338			2108			784	
Travel Time (s)		12.3			11.5			41.1			15.3	
Confl. Peds. (#/hr)	2		20	20		2	7		28	28		7
Peak Hour Factor	0.89	0.89	0.89	0.75	0.75	0.75	0.86	0.86	0.86	0.93	0.93	0.93
Heavy Vehicles (%)	2%	2%	2%	2%	2%	2%	3%	3%	3%	3%	3%	3%
Adj. Flow (vph)	109	2	20	45	1	11	16	1110	15	12	723	84
Shared Lane Traffic (%)												
Lane Group Flow (vph)	0	131	0	0	57	0	16	1125	0	12	807	0
Turn Type	Perm	NA		Perm	NA		Perm	NA		Perm	NA	
Protected Phases		4			8			2			6	
Permitted Phases	4			8			2			6		
Detector Phase	4	4		8	8		2	2		6	6	
Switch Phase												
Minimum Initial (s)	7.0	7.0		7.0	7.0		12.0	12.0		12.0	12.0	
Minimum Split (s)	31.0	31.0		14.0	14.0		28.0	28.0		28.0	28.0	
Total Split (s)	20.0	20.0		20.0	20.0		60.0	60.0		60.0	60.0	
Total Split (%)	25.0%	25.0%		25.0%	25.0%		75.0%	75.0%		75.0%	75.0%	
Maximum Green (s)	14.0	14.0		13.9	13.9		54.0	54.0		54.5	54.5	
Yellow Time (s)	3.5	3.5		3.0	3.0		4.5	4.5		4.0	4.0	
All-Red Time (s)	2.5	2.5		3.1	3.1		1.5	1.5		1.5	1.5	
Lost Time Adjust (s)		-1.0			-1.0		-1.0	-1.0		-0.5	-0.5	
Total Lost Time (s)		5.0			5.1		5.0	5.0		5.0	5.0	
Lead/Lag												
Lead-Lag Optimize?												
Vehicle Extension (s)	3.0	3.0		3.0	3.0		3.0	3.0		3.0	3.0	
Recall Mode	None	None		None	None		Min	Min		Min	Min	
Walk Time (s)	7.0	7.0					7.0	7.0		7.0	7.0	
Flash Dont Walk (s)	17.0	17.0					9.0	9.0		9.0	9.0	
Pedestrian Calls (#/hr)	0	0					0	0		0	0	
Act Effct Green (s)		11.0			10.9		29.4	29.4		29.4	29.4	
Actuated g/C Ratio		0.24			0.24		0.64	0.64		0.64	0.64	

Lanes, Volumes, Timings

14: NC 86 (MLK Jr. Blvd) & Longview Street/Mill Creek Apts Driveway

09/01/2020



Lane Group	EBL	EBT	EBR	WBL	WBT	WBR	NBL	NBT	NBR	SBL	SBT	SBR
v/c Ratio		0.41			0.18		0.04	0.51		0.05	0.36	
Control Delay		21.1			17.7		5.6	7.5		5.9	6.3	
Queue Delay		0.0			0.0		0.0	0.0		0.0	0.0	
Total Delay		21.1			17.7		5.6	7.5		5.9	6.3	
LOS		C			B		A	A		A	A	
Approach Delay		21.1			17.7			7.5			6.3	
Approach LOS		C			B			A			A	
Queue Length 50th (ft)		29			12		2	89		1	55	
Queue Length 95th (ft)		82			34		9	151		8	104	
Internal Link Dist (ft)		371			258			2028			704	
Turn Bay Length (ft)							225			250		
Base Capacity (vph)		460			455		600	3400		391	3444	
Starvation Cap Reductn		0			0		0	0		0	0	
Spillback Cap Reductn		0			0		0	0		0	0	
Storage Cap Reductn		0			0		0	0		0	0	
Reduced v/c Ratio		0.28			0.13		0.03	0.33		0.03	0.23	

Intersection Summary

Area Type:	Other
Cycle Length:	80
Actuated Cycle Length:	45.8
Natural Cycle:	60
Control Type:	Actuated-Uncoordinated
Maximum v/c Ratio:	0.51
Intersection Signal Delay:	8.1
Intersection LOS:	A
Intersection Capacity Utilization:	48.8%
ICU Level of Service:	A
Analysis Period (min):	15

Splits and Phases: 14: NC 86 (MLK Jr. Blvd) & Longview Street/Mill Creek Apts Driveway

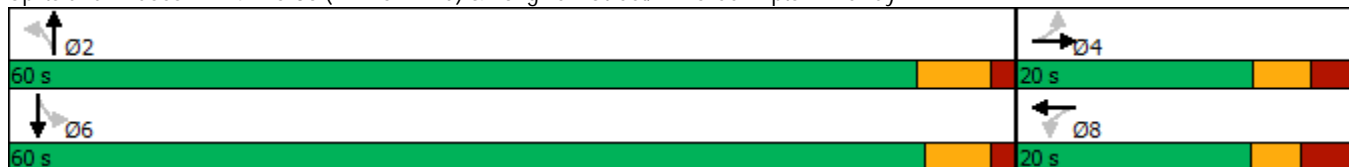

Lanes, Volumes, Timings
 15: NC 86 (Pittsboro St) & W. Cameron Avenue

09/01/2020



Lane Group	EBT	EBR	WBL	WBT	NBL	NBR	Ø1	Ø4
Lane Configurations	↻		↻↻	↻				
Traffic Volume (vph)	149	222	568	365	0	0		
Future Volume (vph)	149	222	568	365	0	0		
Ideal Flow (vphpl)	1900	1900	1900	1900	1900	1900		
Lane Width (ft)	12	12	11	12	12	12		
Grade (%)	3%			-3%	0%			
Storage Length (ft)		0	75		0	0		
Storage Lanes		0	0		0	0		
Taper Length (ft)			25		25			
Lane Util. Factor	1.00	1.00	0.97	1.00	1.00	1.00		
Ped Bike Factor	0.84		0.74					
Frt	0.919							
Flt Protected			0.950					
Satd. Flow (prot)	1269	0	2890	1622	0	0		
Flt Permitted			0.950					
Satd. Flow (perm)	1269	0	2150	1622	0	0		
Right Turn on Red		No				No		
Satd. Flow (RTOR)								
Link Speed (mph)	25			25	25			
Link Distance (ft)	391			120	794			
Travel Time (s)	30.0			10.7	21.7			
Confl. Peds. (#/hr)		70	70					
Peak Hour Factor	0.93	0.93	0.96	0.96	0.90	0.90		
Heavy Vehicles (%)	2%	2%	7%	7%	2%	2%		
Adj. Flow (vph)	160	239	592	380	0	0		
Shared Lane Traffic (%)								
Lane Group Flow (vph)	399	0	592	380	0	0		
Turn Type	NA		Prot	NA				
Protected Phases	2		1 4	6			1	4
Permitted Phases								
Detector Phase	2		1 4	6				
Switch Phase								
Minimum Initial (s)	10.0			10.0			7.0	7.0
Minimum Split (s)	20.1			20.0			20.0	21.0
Total Split (s)	44.0			102.0			58.0	38.0
Total Split (%)	31.4%			72.9%			41%	27%
Maximum Green (s)	38.9			97.0			52.9	34.0
Yellow Time (s)	3.0			3.3			3.0	3.0
All-Red Time (s)	2.1			1.7			2.1	1.0
Lost Time Adjust (s)	-0.1			0.0				
Total Lost Time (s)	5.0			5.0				
Lead/Lag	Lead						Lag	
Lead-Lag Optimize?								
Vehicle Extension (s)	1.0			1.0			4.0	0.2
Recall Mode	None			C-Max			C-Max	None
Walk Time (s)	7.0							7.0
Flash Dont Walk (s)	4.0							9.0
Pedestrian Calls (#/hr)	0							0
Act Effect Green (s)	57.6		72.4	124.0				

Lanes, Volumes, Timings
 15: NC 86 (Pittsboro St) & W. Cameron Avenue

09/01/2020



Lane Group	EBT	EBR	WBL	WBT	NBL	NBR	Ø1	Ø4
Actuated g/C Ratio	0.41		0.52	0.89				
v/c Ratio	0.77		0.40	0.26				
Control Delay	47.5		13.3	1.0				
Queue Delay	0.0		0.1	0.8				
Total Delay	47.5		13.4	1.8				
LOS	D		B	A				
Approach Delay	47.5			8.9				
Approach LOS	D			A				
Queue Length 50th (ft)	325		89	6				
Queue Length 95th (ft)	447		m121	m47				
Internal Link Dist (ft)	311			40	714			
Turn Bay Length (ft)			75					
Base Capacity (vph)	521		2052	1436				
Starvation Cap Reductn	0		505	741				
Spillback Cap Reductn	0		0	0				
Storage Cap Reductn	0		0	0				
Reduced v/c Ratio	0.77		0.38	0.55				

Intersection Summary

Area Type: CBD
 Cycle Length: 140
 Actuated Cycle Length: 140
 Offset: 104 (74%), Referenced to phase 1:WBL and 6:WBT, Start of Green
 Natural Cycle: 70
 Control Type: Actuated-Coordinated
 Maximum v/c Ratio: 0.77
 Intersection Signal Delay: 20.1
 Intersection LOS: C
 Intersection Capacity Utilization 53.1%
 ICU Level of Service A
 Analysis Period (min) 15
 m Volume for 95th percentile queue is metered by upstream signal.

Splits and Phases: 15: NC 86 (Pittsboro St) & W. Cameron Avenue

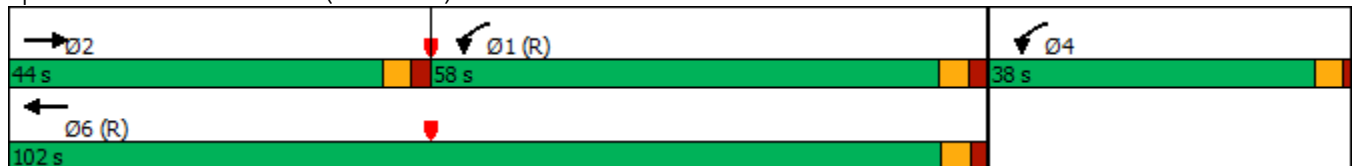

Lanes, Volumes, Timings

16: NC 86 (S. Columbia St) & W. Cameron Avenue/E. Cameron Avenue

09/01/2020

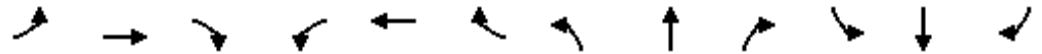

Lane Group	EBL	EBT	EBR	WBL	WBT	WBR	NBL	NBT	NBR	SBL	SBT	SBR
Lane Configurations												
Traffic Volume (vph)	20	123	0	0	168	52	222	675	60	120	0	530
Future Volume (vph)	20	123	0	0	168	52	222	675	60	120	0	530
Ideal Flow (vphpl)	1900	1900	1900	1900	1900	1900	1900	1900	1900	1900	1900	1900
Lane Width (ft)	11	12	12	12	12	12	10	10	10	11	11	12
Grade (%)		1%			-1%			1%			2%	
Storage Length (ft)	100		0	0		0	0		0	310		0
Storage Lanes	1		0	0		0	1		0	1		2
Taper Length (ft)	25			25			25			25		
Lane Util. Factor	1.00	1.00	1.00	1.00	1.00	1.00	0.91	0.91	0.95	1.00	1.00	0.88
Ped Bike Factor	0.86				0.93		0.68	0.94		0.79		0.60
Frt					0.968			0.988				0.850
Flt Protected	0.950						0.950	0.999		0.950		
Satd. Flow (prot)	1532	1668	0	0	1493	0	1295	2543	0	1453	0	2367
Flt Permitted	0.290						0.950	0.999		0.950		
Satd. Flow (perm)	401	1668	0	0	1493	0	884	2519	0	1154	0	1418
Right Turn on Red			No			No			No			No
Satd. Flow (RTOR)												
Link Speed (mph)		25			25			25				25
Link Distance (ft)		273			989			826				981
Travel Time (s)		10.7			57.6			22.5				26.8
Confl. Peds. (#/hr)	157		172	172		157	111		248	248		111
Peak Hour Factor	0.91	0.91	0.91	0.90	0.90	0.90	0.87	0.87	0.87	0.85	0.85	0.85
Heavy Vehicles (%)	2%	2%	2%	4%	4%	4%	6%	6%	6%	7%	7%	7%
Adj. Flow (vph)	22	135	0	0	187	58	255	776	69	141	0	624
Shared Lane Traffic (%)							10%					
Lane Group Flow (vph)	22	135	0	0	245	0	229	871	0	141	0	624
Turn Type	Perm	NA			NA		Split	NA		Prot		Prot
Protected Phases		4			8		2	2		1		1
Permitted Phases	4									1		1
Detector Phase	4	4			8		2	2		1		1
Switch Phase												
Minimum Initial (s)	10.0	10.0			10.0		7.0	7.0		7.0		7.0
Minimum Split (s)	24.0	24.0			31.0		18.0	18.0		26.0		26.0
Total Split (s)	31.0	31.0			31.0		47.0	47.0		34.0		34.0
Total Split (%)	22.1%	22.1%			22.1%		33.6%	33.6%		24.3%		24.3%
Maximum Green (s)	24.8	24.8			24.8		41.1	41.1		28.4		28.4
Yellow Time (s)	3.2	3.2			3.2		3.1	3.1		3.0		3.0
All-Red Time (s)	3.0	3.0			3.0		2.8	2.8		2.6		2.6
Lost Time Adjust (s)	-1.2	-1.2			-1.2		-0.9	-0.9		-0.6		-0.6
Total Lost Time (s)	5.0	5.0			5.0		5.0	5.0		5.0		5.0
Lead/Lag							Lag	Lag		Lead		Lead
Lead-Lag Optimize?												
Vehicle Extension (s)	2.0	2.0			2.0		4.0	4.0		4.0		4.0
Recall Mode	None	None			None		C-Max	C-Max		None		None
Walk Time (s)	7.0	7.0			7.0		7.0	7.0		7.0		7.0
Flash Dont Walk (s)	10.0	10.0			17.0		5.0	5.0		13.0		13.0
Pedestrian Calls (#/hr)	0	0			0		0	0		0		0
Act Effect Green (s)	25.1	25.1			25.1		44.0	44.0		55.9		55.9

Lanes, Volumes, Timings

16: NC 86 (S. Columbia St) & W. Cameron Avenue/E. Cameron Avenue

09/01/2020

Lane Group	Ø9
Lane Configurations	
Traffic Volume (vph)	
Future Volume (vph)	
Ideal Flow (vphpl)	
Lane Width (ft)	
Grade (%)	
Storage Length (ft)	
Storage Lanes	
Taper Length (ft)	
Lane Util. Factor	
Ped Bike Factor	
Flt	
Flt Protected	
Satd. Flow (prot)	
Flt Permitted	
Satd. Flow (perm)	
Right Turn on Red	
Satd. Flow (RTOR)	
Link Speed (mph)	
Link Distance (ft)	
Travel Time (s)	
Confl. Peds. (#/hr)	
Peak Hour Factor	
Heavy Vehicles (%)	
Adj. Flow (vph)	
Shared Lane Traffic (%)	
Lane Group Flow (vph)	
Turn Type	
Protected Phases	9
Permitted Phases	
Detector Phase	
Switch Phase	
Minimum Initial (s)	7.0
Minimum Split (s)	28.0
Total Split (s)	28.0
Total Split (%)	20%
Maximum Green (s)	24.0
Yellow Time (s)	3.0
All-Red Time (s)	1.0
Lost Time Adjust (s)	
Total Lost Time (s)	
Lead/Lag	
Lead-Lag Optimize?	
Vehicle Extension (s)	0.2
Recall Mode	None
Walk Time (s)	7.0
Flash Dont Walk (s)	17.0
Pedestrian Calls (#/hr)	0
Act Effect Green (s)	

Lanes, Volumes, Timings

16: NC 86 (S. Columbia St) & W. Cameron Avenue/E. Cameron Avenue

09/01/2020

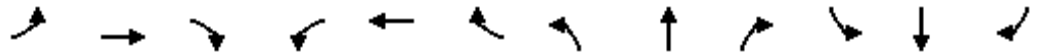

Lane Group	EBL	EBT	EBR	WBL	WBT	WBR	NBL	NBT	NBR	SBL	SBT	SBR
Actuated g/C Ratio	0.18	0.18			0.18		0.31	0.31		0.40		0.40
v/c Ratio	0.31	0.45			0.92		0.56	1.09		0.24		0.66
Control Delay	24.8	21.1			93.4		46.0	103.8		16.1		25.7
Queue Delay	0.0	0.0			0.0		0.0	0.0		0.0		0.0
Total Delay	24.8	21.1			93.4		46.0	103.8		16.1		25.7
LOS	C	C			F		D	F		B		C
Approach Delay		21.6			93.4			91.7			24.0	
Approach LOS		C			F			F			C	
Queue Length 50th (ft)	11	74			220		189	~481		79		266
Queue Length 95th (ft)	m16	m104			#377		278	#593		m97		342
Internal Link Dist (ft)		193			909			746			901	
Turn Bay Length (ft)	100									310		
Base Capacity (vph)	74	309			277		407	799		579		944
Starvation Cap Reductn	0	0			0		0	0		0		0
Spillback Cap Reductn	0	0			0		0	0		0		0
Storage Cap Reductn	0	0			0		0	0		0		0
Reduced v/c Ratio	0.30	0.44			0.88		0.56	1.09		0.24		0.66

Intersection Summary

Area Type: CBD
 Cycle Length: 140
 Actuated Cycle Length: 140
 Offset: 23 (16%), Referenced to phase 2:NBTL, Start of Green
 Natural Cycle: 145
 Control Type: Actuated-Coordinated
 Maximum v/c Ratio: 1.09
 Intersection Signal Delay: 64.2 Intersection LOS: E
 Intersection Capacity Utilization 80.9% ICU Level of Service D
 Analysis Period (min) 15
 ~ Volume exceeds capacity, queue is theoretically infinite.
 Queue shown is maximum after two cycles.
 # 95th percentile volume exceeds capacity, queue may be longer.
 Queue shown is maximum after two cycles.
 m Volume for 95th percentile queue is metered by upstream signal.

Splits and Phases: 16: NC 86 (S. Columbia St) & W. Cameron Avenue/E. Cameron Avenue

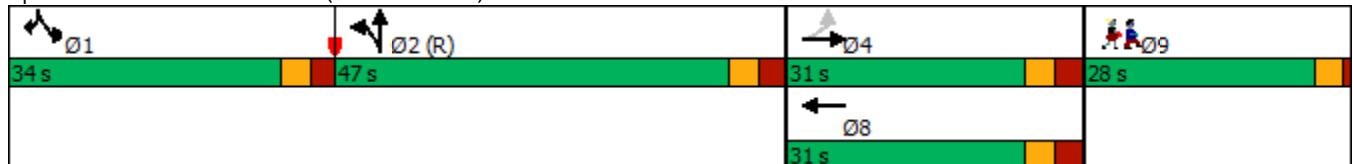

Lanes, Volumes, Timings

16: NC 86 (S. Columbia St) & W. Cameron Avenue/E. Cameron Avenue

09/01/2020

Lane Group	Ø9
Actuated g/C Ratio	
v/c Ratio	
Control Delay	
Queue Delay	
Total Delay	
LOS	
Approach Delay	
Approach LOS	
Queue Length 50th (ft)	
Queue Length 95th (ft)	
Internal Link Dist (ft)	
Turn Bay Length (ft)	
Base Capacity (vph)	
Starvation Cap Reductn	
Spillback Cap Reductn	
Storage Cap Reductn	
Reduced v/c Ratio	
Intersection Summary	

Lanes, Volumes, Timings

17: Raleigh Street & E. Cameron Avenue/Country Club Road

09/01/2020



Lane Group	EBL	EBT	EBR	WBL	WBT	WBR	NBL	NBT	NBR	SBL	SBT	SBR
Lane Configurations		↕		↖	↗		↖	↗		↖	↗	
Traffic Volume (vph)	27	164	47	35	130	183	56	93	62	275	188	54
Future Volume (vph)	27	164	47	35	130	183	56	93	62	275	188	54
Ideal Flow (vphpl)	1900	1900	1900	1900	1900	1900	1900	1900	1900	1900	1900	1900
Grade (%)		-3%			3%			-2%				1%
Storage Length (ft)	0		0	150		0	125		0	75		0
Storage Lanes	0		0	1		0	1		0	1		0
Taper Length (ft)	25			25			25			25		
Lane Util. Factor	1.00	1.00	1.00	1.00	1.00	1.00	1.00	1.00	1.00	1.00	1.00	1.00
Ped Bike Factor		0.94			0.88			0.88		0.82	0.88	
Frt		0.973			0.912			0.940			0.967	
Flt Protected		0.994		0.950			0.950			0.950		
Satd. Flow (prot)	0	1572	0	1569	1326	0	1563	1358	0	1585	1418	0
Flt Permitted		0.924		0.371			0.583			0.447		
Satd. Flow (perm)	0	1442	0	613	1326	0	959	1358	0	610	1418	0
Right Turn on Red			No			No			No			No
Satd. Flow (RTOR)												
Link Speed (mph)		25			25			25				25
Link Distance (ft)		598			651			409				995
Travel Time (s)		16.3			17.8			11.2				27.1
Confl. Peds. (#/hr)	39		37	37		39	107		60	60		107
Peak Hour Factor	0.75	0.75	0.75	0.89	0.89	0.89	0.89	0.89	0.89	0.84	0.84	0.84
Heavy Vehicles (%)	2%	2%	2%	2%	2%	2%	5%	5%	5%	2%	2%	2%
Adj. Flow (vph)	36	219	63	39	146	206	63	104	70	327	224	64
Shared Lane Traffic (%)												
Lane Group Flow (vph)	0	318	0	39	352	0	63	174	0	327	288	0
Turn Type	Perm	NA		pm+pt	NA		pm+pt	NA		pm+pt	NA	
Protected Phases		2		1	6		3	8		7	4	
Permitted Phases	2			6			8			4		
Detector Phase	2	2		1	6		3	8		7	4	
Switch Phase												
Minimum Initial (s)	10.0	10.0		7.0	10.0		7.0	7.0		7.0	7.0	
Minimum Split (s)	18.0	18.0		13.0	19.0		13.0	19.0		12.0	16.0	
Total Split (s)	50.0	50.0		20.0	70.0		20.0	35.0		20.0	35.0	
Total Split (%)	40.0%	40.0%		16.0%	56.0%		16.0%	28.0%		16.0%	28.0%	
Maximum Green (s)	43.9	43.9		14.4	64.4		14.7	29.7		15.1	29.9	
Yellow Time (s)	3.3	3.3		3.0	3.1		3.0	3.1		3.0	3.1	
All-Red Time (s)	2.8	2.8		2.6	2.5		2.3	2.2		1.9	2.0	
Lost Time Adjust (s)		-1.1		-0.6	-0.6		-0.3	-0.3		0.1	-0.1	
Total Lost Time (s)		5.0		5.0	5.0		5.0	5.0		5.0	5.0	
Lead/Lag	Lag	Lag		Lead			Lead	Lag		Lead	Lag	
Lead-Lag Optimize?	Yes	Yes		Yes			Yes	Yes		Yes	Yes	
Vehicle Extension (s)	2.0	2.0		2.0	2.0		2.0	2.0		2.0	2.0	
Recall Mode	None	None		None	None		None	None		None	None	
Walk Time (s)	4.0	4.0			4.0			4.0			4.0	
Flash Dont Walk (s)	7.0	7.0			9.0			9.0			6.0	
Pedestrian Calls (#/hr)	0	0			0			0			0	
Act Effect Green (s)		24.8		31.3	31.3		24.3	16.0		37.3	27.4	
Actuated g/C Ratio		0.31		0.39	0.39		0.31	0.20		0.47	0.35	

Lanes, Volumes, Timings

17: Raleigh Street & E. Cameron Avenue/Country Club Road

09/01/2020



Lane Group	EBL	EBT	EBR	WBL	WBT	WBR	NBL	NBT	NBR	SBL	SBT	SBR
v/c Ratio		0.71		0.11	0.67		0.18	0.64		0.68	0.59	
Control Delay		35.5		15.3	26.5		17.7	43.3		26.8	33.0	
Queue Delay		0.0		0.0	0.0		0.0	0.0		0.0	0.0	
Total Delay		35.5		15.3	26.5		17.7	43.3		26.8	33.0	
LOS		D		B	C		B	D		C	C	
Approach Delay		35.5			25.4			36.5			29.7	
Approach LOS		D			C			D			C	
Queue Length 50th (ft)		149		11	134		19	85		119	135	
Queue Length 95th (ft)		216		32	256		52	175		#243	253	
Internal Link Dist (ft)		518			571			329			915	
Turn Bay Length (ft)				150			125			75		
Base Capacity (vph)		883		441	1080		512	555		485	583	
Starvation Cap Reductn		0		0	0		0	0		0	0	
Spillback Cap Reductn		0		0	0		0	0		0	0	
Storage Cap Reductn		0		0	0		0	0		0	0	
Reduced v/c Ratio		0.36		0.09	0.33		0.12	0.31		0.67	0.49	

Intersection Summary

Area Type: CBD
 Cycle Length: 125
 Actuated Cycle Length: 79.4
 Natural Cycle: 70
 Control Type: Actuated-Uncoordinated
 Maximum v/c Ratio: 0.71
 Intersection Signal Delay: 30.8
 Intersection LOS: C
 Intersection Capacity Utilization 80.2%
 ICU Level of Service D
 Analysis Period (min) 15
 # 95th percentile volume exceeds capacity, queue may be longer.
 Queue shown is maximum after two cycles.

Splits and Phases: 17: Raleigh Street & E. Cameron Avenue/Country Club Road

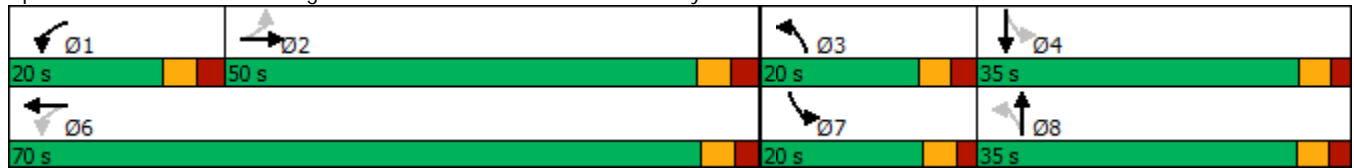



Appendix E – Synchro Unsignalized HCM Analysis Output

2020 Existing Base Year

HCM 6th TWSC
 3: E. Rosemary Street & Rosemary Deck Ent/Exit

2020 Existing AM Peak
 Timing Plan: AM Peak

Intersection						
Int Delay, s/veh	0.6					
Movement	EBL	EBT	WBT	WBR	SBL	SBR
Lane Configurations						
Traffic Vol, veh/h	27	253	220	40	2	2
Future Vol, veh/h	27	253	220	40	2	2
Conflicting Peds, #/hr	16	0	0	16	0	0
Sign Control	Free	Free	Free	Free	Stop	Stop
RT Channelized	-	None	-	None	-	None
Storage Length	125	-	-	-	0	-
Veh in Median Storage, #	-	0	0	-	0	-
Grade, %	-	-3	2	-	0	-
Peak Hour Factor	90	90	90	90	50	50
Heavy Vehicles, %	2	2	2	2	2	2
Mvmt Flow	30	281	244	44	4	4

Major/Minor	Major1	Major2	Minor2		
Conflicting Flow All	304	0	-	0	623
Stage 1	-	-	-	-	282
Stage 2	-	-	-	-	341
Critical Hdwy	4.12	-	-	-	6.42
Critical Hdwy Stg 1	-	-	-	-	5.42
Critical Hdwy Stg 2	-	-	-	-	5.42
Follow-up Hdwy	2.218	-	-	-	3.518
Pot Cap-1 Maneuver	1257	-	-	-	450
Stage 1	-	-	-	-	766
Stage 2	-	-	-	-	720
Platoon blocked, %		-	-	-	
Mov Cap-1 Maneuver	1238	-	-	-	426
Mov Cap-2 Maneuver	-	-	-	-	524
Stage 1	-	-	-	-	736
Stage 2	-	-	-	-	709

Approach	EB	WB	SB
HCM Control Delay, s	0.8	0	10.9
HCM LOS			B

Minor Lane/Major Mvmt	EBL	EBT	WBT	WBR	SBLn1
Capacity (veh/h)	1238	-	-	-	615
HCM Lane V/C Ratio	0.024	-	-	-	0.013
HCM Control Delay (s)	8	-	-	-	10.9
HCM Lane LOS	A	-	-	-	B
HCM 95th %tile Q(veh)	0.1	-	-	-	0

HCM 6th TWSC
 4: Wallace Parking Deck Ent, Exit 1 & E. Rosemary Street

2020 Existing AM Peak
 Timing Plan: AM Peak

Intersection						
Int Delay, s/veh	1.1					
Movement	EBT	EBR	WBL	WBT	NBL	NBR
Lane Configurations						
Traffic Vol, veh/h	189	57	56	268	5	3
Future Vol, veh/h	189	57	56	268	5	3
Conflicting Peds, #/hr	0	12	12	0	0	0
Sign Control	Free	Free	Free	Free	Stop	Stop
RT Channelized	-	None	-	None	-	None
Storage Length	-	-	90	-	0	-
Veh in Median Storage, #	0	-	-	0	0	-
Grade, %	0	-	-	-2	0	-
Peak Hour Factor	90	90	90	90	50	50
Heavy Vehicles, %	2	2	2	2	2	2
Mvmt Flow	210	63	62	298	10	6

Major/Minor	Major1	Major2	Minor1		
Conflicting Flow All	0	0	285	0	676 254
Stage 1	-	-	-	-	254 -
Stage 2	-	-	-	-	422 -
Critical Hdwy	-	-	4.12	-	6.42 6.22
Critical Hdwy Stg 1	-	-	-	-	5.42 -
Critical Hdwy Stg 2	-	-	-	-	5.42 -
Follow-up Hdwy	-	-	2.218	-	3.518 3.318
Pot Cap-1 Maneuver	-	-	1277	-	419 785
Stage 1	-	-	-	-	788 -
Stage 2	-	-	-	-	662 -
Platoon blocked, %	-	-	-	-	-
Mov Cap-1 Maneuver	-	-	1262	-	394 776
Mov Cap-2 Maneuver	-	-	-	-	493 -
Stage 1	-	-	-	-	779 -
Stage 2	-	-	-	-	630 -

Approach	EB	WB	NB
HCM Control Delay, s	0	1.4	11.5
HCM LOS			B

Minor Lane/Major Mvmt	NBLn1	EBT	EBR	WBL	WBT
Capacity (veh/h)	571	-	-	1262	-
HCM Lane V/C Ratio	0.028	-	-	0.049	-
HCM Control Delay (s)	11.5	-	-	8	-
HCM Lane LOS	B	-	-	A	-
HCM 95th %tile Q(veh)	0.1	-	-	0.2	-

HCM 6th TWSC
5: Wallace Parking Deck Exit 2 & E. Rosemary Street

2020 Existing AM Peak
Timing Plan: AM Peak

Intersection						
Int Delay, s/veh	0.3					
Movement	EBT	EBR	WBL	WBT	NBL	NBR
Lane Configurations						
Traffic Vol, veh/h	189	3	5	321	3	3
Future Vol, veh/h	189	3	5	321	3	3
Conflicting Peds, #/hr	0	0	0	0	0	0
Sign Control	Free	Free	Free	Free	Stop	Stop
RT Channelized	-	None	-	None	-	None
Storage Length	-	-	-	-	0	-
Veh in Median Storage, #	0	-	-	0	0	-
Grade, %	2	-	-	-2	0	-
Peak Hour Factor	90	90	90	90	50	50
Heavy Vehicles, %	2	2	2	2	2	2
Mvmt Flow	210	3	6	357	6	6

Major/Minor	Major1	Major2	Minor1		
Conflicting Flow All	0	0	213	0	581 212
Stage 1	-	-	-	-	212 -
Stage 2	-	-	-	-	369 -
Critical Hdwy	-	-	4.12	-	6.42 6.22
Critical Hdwy Stg 1	-	-	-	-	5.42 -
Critical Hdwy Stg 2	-	-	-	-	5.42 -
Follow-up Hdwy	-	-	2.218	-	3.518 3.318
Pot Cap-1 Maneuver	-	-	1357	-	476 828
Stage 1	-	-	-	-	823 -
Stage 2	-	-	-	-	699 -
Platoon blocked, %	-	-	-	-	-
Mov Cap-1 Maneuver	-	-	1357	-	473 828
Mov Cap-2 Maneuver	-	-	-	-	556 -
Stage 1	-	-	-	-	823 -
Stage 2	-	-	-	-	695 -

Approach	EB	WB	NB
HCM Control Delay, s	0	0.1	10.5
HCM LOS			B

Minor Lane/Major Mvmt	NBLn1	EBT	EBR	WBL	WBT
Capacity (veh/h)	665	-	-	1357	-
HCM Lane V/C Ratio	0.018	-	-	0.004	-
HCM Control Delay (s)	10.5	-	-	7.7	0
HCM Lane LOS	B	-	-	A	A
HCM 95th %tile Q(veh)	0.1	-	-	0	-

Intersection

Int Delay, s/veh 1.5

Movement	WBL	WBR	NBL	NBT	NBR	SBL	SBT	SBR	SEL	SER
Lane Configurations										
Traffic Vol, veh/h	2	3	37	423	3	9	715	2	6	53
Future Vol, veh/h	2	3	37	423	3	9	715	2	6	53
Conflicting Peds, #/hr	0	0	1	0	15	15	0	1	0	0
Sign Control	Stop	Stop	Free	Free	Free	Free	Free	Free	Stop	Stop
RT Channelized	-	-	-	-	None	-	-	None	-	None
Storage Length	0	-	150	-	-	70	-	-	0	-
Veh in Median Storage, #	0	-	-	0	-	-	0	-	0	-
Grade, %	2	-	-	-5	-	-	5	-	-3	-
Peak Hour Factor	48	48	93	93	93	89	89	89	76	76
Heavy Vehicles, %	10	10	7	7	7	5	5	5	8	8
Mvmt Flow	4	6	40	455	3	10	803	2	8	70

Major/Minor	Minor1	Major1	Major2	Minor2
Conflicting Flow All	978	244	806	404
Stage 1	552	-	-	-
Stage 2	426	-	-	-
Critical Hdwy	8.1	7.3	4.24	6.76
Critical Hdwy Stg 1	7.1	-	-	-
Critical Hdwy Stg 2	7.1	-	-	-
Follow-up Hdwy	3.6	3.4	2.27	3.38
Pot Cap-1 Maneuver	174	723	783	599
Stage 1	438	-	-	-
Stage 2	530	-	-	-
Platoon blocked, %				
Mov Cap-1 Maneuver	139	713	782	598
Mov Cap-2 Maneuver	139	-	-	-
Stage 1	410	-	-	-
Stage 2	455	-	-	-

Approach	WB	NB	SB	SE
HCM Control Delay, s	13.2	0.8	0.1	15.1
HCM LOS	B			C

Minor Lane/Major Mvmt	NBL	NBT	NBRWBLn1	SELn1	SBL	SBT	SBR
Capacity (veh/h)	782	-	-	470	438	1049	-
HCM Lane V/C Ratio	0.051	-	-	0.071	0.183	0.01	-
HCM Control Delay (s)	9.8	-	-	13.2	15.1	8.5	-
HCM Lane LOS	A	-	-	B	C	A	-
HCM 95th %tile Q(veh)	0.2	-	-	0.2	0.7	0	-

HCM 6th TWSC
 3: E. Rosemary Street & Rosemary Deck Ent/Exit

2020 Existing Noon Peak
 Timing Plan: Noon Peak

Intersection						
Int Delay, s/veh	1.7					
Movement	EBL	EBT	WBT	WBR	SBL	SBR
Lane Configurations						
Traffic Vol, veh/h	43	316	230	40	19	26
Future Vol, veh/h	43	316	230	40	19	26
Conflicting Peds, #/hr	16	0	0	16	0	0
Sign Control	Free	Free	Free	Free	Stop	Stop
RT Channelized	-	None	-	None	-	None
Storage Length	125	-	-	-	0	-
Veh in Median Storage, #	-	0	0	-	0	-
Grade, %	-	-3	2	-	0	-
Peak Hour Factor	90	90	90	90	56	56
Heavy Vehicles, %	2	2	2	2	2	2
Mvmt Flow	48	351	256	44	34	46

Major/Minor	Major1	Major2	Minor2		
Conflicting Flow All	316	0	-	0	741
Stage 1	-	-	-	-	294
Stage 2	-	-	-	-	447
Critical Hdwy	4.12	-	-	-	6.42
Critical Hdwy Stg 1	-	-	-	-	5.42
Critical Hdwy Stg 2	-	-	-	-	5.42
Follow-up Hdwy	2.218	-	-	-	3.518
Pot Cap-1 Maneuver	1244	-	-	-	384
Stage 1	-	-	-	-	756
Stage 2	-	-	-	-	644
Platoon blocked, %		-	-	-	
Mov Cap-1 Maneuver	1225	-	-	-	358
Mov Cap-2 Maneuver	-	-	-	-	469
Stage 1	-	-	-	-	716
Stage 2	-	-	-	-	634

Approach	EB	WB	SB
HCM Control Delay, s	1	0	12
HCM LOS			B

Minor Lane/Major Mvmt	EBL	EBT	WBT	WBR	SBLn1
Capacity (veh/h)	1225	-	-	-	593
HCM Lane V/C Ratio	0.039	-	-	-	0.136
HCM Control Delay (s)	8.1	-	-	-	12
HCM Lane LOS	A	-	-	-	B
HCM 95th %tile Q(veh)	0.1	-	-	-	0.5

HCM 6th TWSC
4: Wallace Parking Deck Ent, Exit 1 & E. Rosemary Street

2020 Existing Noon Peak
Timing Plan: Noon Peak

Intersection						
Int Delay, s/veh	1.5					
Movement	EBT	EBR	WBL	WBT	NBL	NBR
Lane Configurations						
Traffic Vol, veh/h	295	38	33	255	17	23
Future Vol, veh/h	295	38	33	255	17	23
Conflicting Peds, #/hr	0	12	12	0	0	0
Sign Control	Free	Free	Free	Free	Stop	Stop
RT Channelized	-	None	-	None	-	None
Storage Length	-	-	90	-	0	-
Veh in Median Storage, #	0	-	-	0	0	-
Grade, %	0	-	-	-2	0	-
Peak Hour Factor	90	90	90	90	59	59
Heavy Vehicles, %	2	2	2	2	2	2
Mvmt Flow	328	42	37	283	29	39

Major/Minor	Major1	Major2	Minor1		
Conflicting Flow All	0	0	382	0	718 361
Stage 1	-	-	-	-	361 -
Stage 2	-	-	-	-	357 -
Critical Hdwy	-	-	4.12	-	6.42 6.22
Critical Hdwy Stg 1	-	-	-	-	5.42 -
Critical Hdwy Stg 2	-	-	-	-	5.42 -
Follow-up Hdwy	-	-	2.218	-	3.518 3.318
Pot Cap-1 Maneuver	-	-	1176	-	396 684
Stage 1	-	-	-	-	705 -
Stage 2	-	-	-	-	708 -
Platoon blocked, %	-	-	-	-	-
Mov Cap-1 Maneuver	-	-	1163	-	379 676
Mov Cap-2 Maneuver	-	-	-	-	488 -
Stage 1	-	-	-	-	697 -
Stage 2	-	-	-	-	685 -

Approach	EB	WB	NB
HCM Control Delay, s	0	0.9	12
HCM LOS			B

Minor Lane/Major Mvmt	NBLn1	EBT	EBR	WBL	WBT
Capacity (veh/h)	581	-	-	1163	-
HCM Lane V/C Ratio	0.117	-	-	0.032	-
HCM Control Delay (s)	12	-	-	8.2	-
HCM Lane LOS	B	-	-	A	-
HCM 95th %tile Q(veh)	0.4	-	-	0.1	-

HCM 6th TWSC
 5: Wallace Parking Deck Exit 2 & E. Rosemary Street

2020 Existing Noon Peak
 Timing Plan: Noon Peak

Intersection						
Int Delay, s/veh	0.8					
Movement	EBT	EBR	WBL	WBT	NBL	NBR
Lane Configurations						
Traffic Vol, veh/h	315	3	1	276	12	26
Future Vol, veh/h	315	3	1	276	12	26
Conflicting Peds, #/hr	0	0	0	0	0	0
Sign Control	Free	Free	Free	Free	Stop	Stop
RT Channelized	-	None	-	None	-	None
Storage Length	-	-	-	-	0	-
Veh in Median Storage, #	0	-	-	0	0	-
Grade, %	2	-	-	-2	0	-
Peak Hour Factor	90	90	90	90	72	72
Heavy Vehicles, %	2	2	2	2	2	2
Mvmt Flow	350	3	1	307	17	36

Major/Minor	Major1	Major2	Minor1	Minor2	Minor3
Conflicting Flow All	0	0	353	0	661
Stage 1	-	-	-	-	352
Stage 2	-	-	-	-	309
Critical Hdwy	-	-	4.12	-	6.42
Critical Hdwy Stg 1	-	-	-	-	5.42
Critical Hdwy Stg 2	-	-	-	-	5.42
Follow-up Hdwy	-	-	2.218	-	3.518
Pot Cap-1 Maneuver	-	-	1206	-	427
Stage 1	-	-	-	-	712
Stage 2	-	-	-	-	745
Platoon blocked, %	-	-	-	-	-
Mov Cap-1 Maneuver	-	-	1206	-	427
Mov Cap-2 Maneuver	-	-	-	-	527
Stage 1	-	-	-	-	712
Stage 2	-	-	-	-	744

Approach	EB	WB	NB
HCM Control Delay, s	0	0	11.2
HCM LOS			B

Minor Lane/Major Mvmt	NBLn1	EBT	EBR	WBL	WBT
Capacity (veh/h)	630	-	-	1206	-
HCM Lane V/C Ratio	0.084	-	-	0.001	-
HCM Control Delay (s)	11.2	-	-	8	0
HCM Lane LOS	B	-	-	A	A
HCM 95th %tile Q(veh)	0.3	-	-	0	-

Intersection

Int Delay, s/veh 2.2

Movement	WBL	WBR	NBL	NBT	NBR	SBL	SBT	SBR	SEL	SER
Lane Configurations										
Traffic Vol, veh/h	8	9	43	439	4	9	506	6	7	58
Future Vol, veh/h	8	9	43	439	4	9	506	6	7	58
Conflicting Peds, #/hr	0	0	6	0	41	41	0	6	0	0
Sign Control	Stop	Stop	Free	Free	Free	Free	Free	Free	Stop	Stop
RT Channelized	-	-	-	-	None	-	-	None	-	None
Storage Length	0	-	150	-	-	70	-	-	0	-
Veh in Median Storage, #	0	-	-	0	-	-	0	-	0	-
Grade, %	2	-	-	-5	-	-	5	-	-3	-
Peak Hour Factor	75	75	93	93	93	87	87	87	75	75
Heavy Vehicles, %	2	2	7	7	7	5	5	5	8	8
Mvmt Flow	11	12	46	472	4	10	582	7	9	77

Major/Minor	Minor1	Major1	Major2	Minor2
Conflicting Flow All	923	287	595	0
Stage 1	607	-	-	-
Stage 2	316	-	-	-
Critical Hdwy	7.94	7.14	4.24	-
Critical Hdwy Stg 1	6.94	-	-	-
Critical Hdwy Stg 2	6.94	-	-	-
Follow-up Hdwy	3.52	3.32	2.27	-
Pot Cap-1 Maneuver	203	698	944	-
Stage 1	421	-	-	-
Stage 2	646	-	-	-
Platoon blocked, %				
Mov Cap-1 Maneuver	159	666	939	-
Mov Cap-2 Maneuver	159	-	-	-
Stage 1	385	-	-	-
Stage 2	557	-	-	-

Approach	WB	NB	SB	SE
HCM Control Delay, s	14.6	0.8	0.2	13.3
HCM LOS	B			B

Minor Lane/Major Mvmt	NBL	NBT	NBR	WBLn1	SELn1	SBL	SBT	SBR
Capacity (veh/h)	939	-	-	444	522	984	-	-
HCM Lane V/C Ratio	0.049	-	-	0.153	0.169	0.011	-	-
HCM Control Delay (s)	9	-	-	14.6	13.3	8.7	-	-
HCM Lane LOS	A	-	-	B	B	A	-	-
HCM 95th %tile Q(veh)	0.2	-	-	0.5	0.6	0	-	-

HCM 6th TWSC
 3: E. Rosemary Street & Rosemary Deck Ent/Exit

2020 Existing PM Peak
 Timing Plan: PM Peak

Intersection						
Int Delay, s/veh	1.5					
Movement	EBL	EBT	WBT	WBR	SBL	SBR
Lane Configurations						
Traffic Vol, veh/h	13	394	267	10	27	52
Future Vol, veh/h	13	394	267	10	27	52
Conflicting Peds, #/hr	16	0	0	16	0	0
Sign Control	Free	Free	Free	Free	Stop	Stop
RT Channelized	-	None	-	None	-	None
Storage Length	125	-	-	-	0	-
Veh in Median Storage, #	-	0	0	-	0	-
Grade, %	-	-3	2	-	0	-
Peak Hour Factor	92	92	92	92	83	83
Heavy Vehicles, %	2	2	2	2	2	2
Mvmt Flow	14	428	290	11	33	63

Major/Minor	Major1	Major2	Minor2		
Conflicting Flow All	317	0	-	0	768
Stage 1	-	-	-	-	312
Stage 2	-	-	-	-	456
Critical Hdwy	4.12	-	-	-	6.42
Critical Hdwy Stg 1	-	-	-	-	5.42
Critical Hdwy Stg 2	-	-	-	-	5.42
Follow-up Hdwy	2.218	-	-	-	3.518
Pot Cap-1 Maneuver	1243	-	-	-	370
Stage 1	-	-	-	-	742
Stage 2	-	-	-	-	638
Platoon blocked, %		-	-	-	
Mov Cap-1 Maneuver	1224	-	-	-	355
Mov Cap-2 Maneuver	-	-	-	-	467
Stage 1	-	-	-	-	723
Stage 2	-	-	-	-	628

Approach	EB	WB	SB
HCM Control Delay, s	0.3	0	12
HCM LOS			B

Minor Lane/Major Mvmt	EBL	EBT	WBT	WBR	SBLn1
Capacity (veh/h)	1224	-	-	-	606
HCM Lane V/C Ratio	0.012	-	-	-	0.157
HCM Control Delay (s)	8	-	-	-	12
HCM Lane LOS	A	-	-	-	B
HCM 95th %tile Q(veh)	0	-	-	-	0.6

HCM 6th TWSC
 4: Wallace Parking Deck Ent, Exit 1 & E. Rosemary Street

2020 Existing PM Peak
 Timing Plan: PM Peak

Intersection						
Int Delay, s/veh	1.6					
Movement	EBT	EBR	WBL	WBT	NBL	NBR
Lane Configurations						
Traffic Vol, veh/h	398	31	25	253	15	60
Future Vol, veh/h	398	31	25	253	15	60
Conflicting Peds, #/hr	0	12	12	0	0	0
Sign Control	Free	Free	Free	Free	Stop	Stop
RT Channelized	-	None	-	None	-	None
Storage Length	-	-	90	-	0	-
Veh in Median Storage, #	0	-	-	0	0	-
Grade, %	0	-	-	-2	0	-
Peak Hour Factor	92	92	92	92	82	82
Heavy Vehicles, %	2	2	2	2	2	2
Mvmt Flow	433	34	27	275	18	73

Major/Minor	Major1	Major2	Minor1	Minor2	Minor3
Conflicting Flow All	0	0	479	0	791
Stage 1	-	-	-	-	462
Stage 2	-	-	-	-	329
Critical Hdwy	-	-	4.12	-	6.42
Critical Hdwy Stg 1	-	-	-	-	5.42
Critical Hdwy Stg 2	-	-	-	-	5.42
Follow-up Hdwy	-	-	2.218	-	3.518
Pot Cap-1 Maneuver	-	-	1083	-	358
Stage 1	-	-	-	-	634
Stage 2	-	-	-	-	729
Platoon blocked, %	-	-	-	-	-
Mov Cap-1 Maneuver	-	-	1071	-	345
Mov Cap-2 Maneuver	-	-	-	-	460
Stage 1	-	-	-	-	627
Stage 2	-	-	-	-	711

Approach	EB	WB	NB
HCM Control Delay, s	0	0.8	12.7
HCM LOS			B

Minor Lane/Major Mvmt	NBLn1	EBT	EBR	WBL	WBT
Capacity (veh/h)	561	-	-	1071	-
HCM Lane V/C Ratio	0.163	-	-	0.025	-
HCM Control Delay (s)	12.7	-	-	8.4	-
HCM Lane LOS	B	-	-	A	-
HCM 95th %tile Q(veh)	0.6	-	-	0.1	-

Intersection						
Int Delay, s/veh	1.1					
Movement	EBT	EBR	WBL	WBT	NBL	NBR
Lane Configurations						
Traffic Vol, veh/h	458	0	3	258	20	35
Future Vol, veh/h	458	0	3	258	20	35
Conflicting Peds, #/hr	0	0	0	0	0	0
Sign Control	Free	Free	Free	Free	Stop	Stop
RT Channelized	-	None	-	None	-	None
Storage Length	-	-	-	-	0	-
Veh in Median Storage, #	0	-	-	0	0	-
Grade, %	2	-	-	-2	0	-
Peak Hour Factor	92	92	92	92	75	75
Heavy Vehicles, %	2	2	2	2	2	2
Mvmt Flow	498	0	3	280	27	47

Major/Minor	Major1	Major2	Minor1	Minor2	Minor3
Conflicting Flow All	0	0	498	0	784
Stage 1	-	-	-	-	498
Stage 2	-	-	-	-	286
Critical Hdwy	-	-	4.12	-	6.42
Critical Hdwy Stg 1	-	-	-	-	5.42
Critical Hdwy Stg 2	-	-	-	-	5.42
Follow-up Hdwy	-	-	2.218	-	3.518
Pot Cap-1 Maneuver	-	-	1066	-	362
Stage 1	-	-	-	-	611
Stage 2	-	-	-	-	763
Platoon blocked, %	-	-	-	-	-
Mov Cap-1 Maneuver	-	-	1066	-	361
Mov Cap-2 Maneuver	-	-	-	-	470
Stage 1	-	-	-	-	611
Stage 2	-	-	-	-	761

Approach	EB	WB	NB
HCM Control Delay, s	0	0.1	12.9
HCM LOS			B

Minor Lane/Major Mvmt	NBLn1	EBT	EBR	WBL	WBT
Capacity (veh/h)	530	-	-	1066	-
HCM Lane V/C Ratio	0.138	-	-	0.003	-
HCM Control Delay (s)	12.9	-	-	8.4	0
HCM Lane LOS	B	-	-	A	A
HCM 95th %tile Q(veh)	0.5	-	-	0	-

Intersection

Int Delay, s/veh 7.2

Movement	WBL	WBR	NBL	NBT	NBR	SBL	SBT	SBR	SEL	SER
Lane Configurations										
Traffic Vol, veh/h	24	21	48	755	23	25	708	6	5	98
Future Vol, veh/h	24	21	48	755	23	25	708	6	5	98
Conflicting Peds, #/hr	0	0	7	0	32	32	0	7	0	0
Sign Control	Stop	Stop	Free	Free	Free	Free	Free	Free	Stop	Stop
RT Channelized	-	-	-	-	None	-	-	None	-	None
Storage Length	0	-	150	-	-	70	-	-	0	-
Veh in Median Storage, #	0	-	-	0	-	-	0	-	0	-
Grade, %	2	-	-	-5	-	-	5	-	-3	-
Peak Hour Factor	87	87	83	83	83	88	88	88	92	92
Heavy Vehicles, %	2	2	3	3	3	3	3	3	5	5
Mvmt Flow	28	24	58	910	28	28	805	7	5	107

Major/Minor	Minor1	Major1	Major2	Minor2
Conflicting Flow All	1533	509	819	413
Stage 1	1072	-	-	-
Stage 2	461	-	-	-
Critical Hdwy	7.94	7.14	4.16	6.7
Critical Hdwy Stg 1	6.94	-	-	-
Critical Hdwy Stg 2	6.94	-	-	-
Follow-up Hdwy	3.52	3.32	2.23	3.35
Pot Cap-1 Maneuver	67	495	799	600
Stage 1	209	-	-	-
Stage 2	522	-	-	-
Platoon blocked, %				
Mov Cap-1 Maneuver	46	476	794	596
Mov Cap-2 Maneuver	46	-	-	-
Stage 1	188	-	-	-
Stage 2	405	-	-	-

Approach	WB	NB	SB	SE
HCM Control Delay, s	85.5	0.6	0.4	21.4
HCM LOS	F			C

Minor Lane/Major Mvmt	NBL	NBT	NBR	WBLn1	SELn1	SBL	SBT	SBR
Capacity (veh/h)	794	-	-	144	335	679	-	-
HCM Lane V/C Ratio	0.073	-	-	0.774	0.347	0.042	-	-
HCM Control Delay (s)	9.9	-	-	85.5	21.4	10.5	-	-
HCM Lane LOS	A	-	-	F	C	B	-	-
HCM 95th %tile Q(veh)	0.2	-	-	4.7	1.5	0.1	-	-



2022 Without Parking Deck Site

Intersection						
Int Delay, s/veh	0.6					
Movement	EBL	EBT	WBT	WBR	SBL	SBR
Lane Configurations						
Traffic Vol, veh/h	28	267	229	41	2	2
Future Vol, veh/h	28	267	229	41	2	2
Conflicting Peds, #/hr	16	0	0	16	0	0
Sign Control	Free	Free	Free	Free	Stop	Stop
RT Channelized	-	None	-	None	-	None
Storage Length	125	-	-	-	0	-
Veh in Median Storage, #	-	0	0	-	0	-
Grade, %	-	-3	2	-	0	-
Peak Hour Factor	90	90	90	90	50	50
Heavy Vehicles, %	2	2	2	2	2	2
Mvmt Flow	31	297	254	46	4	4

Major/Minor	Major1	Major2	Minor2		
Conflicting Flow All	316	0	-	0	652 293
Stage 1	-	-	-	-	293 -
Stage 2	-	-	-	-	359 -
Critical Hdwy	4.12	-	-	-	6.42 6.22
Critical Hdwy Stg 1	-	-	-	-	5.42 -
Critical Hdwy Stg 2	-	-	-	-	5.42 -
Follow-up Hdwy	2.218	-	-	-	3.518 3.318
Pot Cap-1 Maneuver	1244	-	-	-	433 746
Stage 1	-	-	-	-	757 -
Stage 2	-	-	-	-	707 -
Platoon blocked, %		-	-	-	
Mov Cap-1 Maneuver	1225	-	-	-	410 735
Mov Cap-2 Maneuver	-	-	-	-	511 -
Stage 1	-	-	-	-	727 -
Stage 2	-	-	-	-	696 -

Approach	EB	WB	SB
HCM Control Delay, s	0.8	0	11.1
HCM LOS			B

Minor Lane/Major Mvmt	EBL	EBT	WBT	WBR	SBLn1
Capacity (veh/h)	1225	-	-	-	603
HCM Lane V/C Ratio	0.025	-	-	-	0.013
HCM Control Delay (s)	8	-	-	-	11.1
HCM Lane LOS	A	-	-	-	B
HCM 95th %tile Q(veh)	0.1	-	-	-	0

Intersection						
Int Delay, s/veh	1.1					
Movement	EBT	EBR	WBL	WBT	NBL	NBR
Lane Configurations						
Traffic Vol, veh/h	198	58	57	278	5	3
Future Vol, veh/h	198	58	57	278	5	3
Conflicting Peds, #/hr	0	12	12	0	0	0
Sign Control	Free	Free	Free	Free	Stop	Stop
RT Channelized	-	None	-	None	-	None
Storage Length	-	-	90	-	0	-
Veh in Median Storage, #	0	-	-	0	0	-
Grade, %	0	-	-	-2	0	-
Peak Hour Factor	90	90	90	90	50	50
Heavy Vehicles, %	2	2	2	2	2	2
Mvmt Flow	220	64	63	309	10	6

Major/Minor	Major1	Major2	Minor1		
Conflicting Flow All	0	0	296	0	699
Stage 1	-	-	-	-	264
Stage 2	-	-	-	-	435
Critical Hdwy	-	-	4.12	-	6.42
Critical Hdwy Stg 1	-	-	-	-	5.42
Critical Hdwy Stg 2	-	-	-	-	5.42
Follow-up Hdwy	-	-	2.218	-	3.518
Pot Cap-1 Maneuver	-	-	1265	-	406
Stage 1	-	-	-	-	780
Stage 2	-	-	-	-	653
Platoon blocked, %	-	-	-	-	-
Mov Cap-1 Maneuver	-	-	1251	-	382
Mov Cap-2 Maneuver	-	-	-	-	483
Stage 1	-	-	-	-	771
Stage 2	-	-	-	-	620

Approach	EB	WB	NB
HCM Control Delay, s	0	1.4	11.6
HCM LOS			B

Minor Lane/Major Mvmt	NBLn1	EBT	EBR	WBL	WBT
Capacity (veh/h)	561	-	-	1251	-
HCM Lane V/C Ratio	0.029	-	-	0.051	-
HCM Control Delay (s)	11.6	-	-	8	-
HCM Lane LOS	B	-	-	A	-
HCM 95th %tile Q(veh)	0.1	-	-	0.2	-

HCM 6th TWSC
 5: Wallace Parking Deck Exit 2 & E. Rosemary Street

09/01/2020

Intersection						
Int Delay, s/veh	0.3					
Movement	EBT	EBR	WBL	WBT	NBL	NBR
Lane Configurations						
Traffic Vol, veh/h	203	3	5	332	3	3
Future Vol, veh/h	203	3	5	332	3	3
Conflicting Peds, #/hr	0	0	0	0	0	0
Sign Control	Free	Free	Free	Free	Stop	Stop
RT Channelized	-	None	-	None	-	None
Storage Length	-	-	-	-	0	-
Veh in Median Storage, #	0	-	-	0	0	-
Grade, %	2	-	-	-2	0	-
Peak Hour Factor	90	90	90	90	50	50
Heavy Vehicles, %	2	2	2	2	2	2
Mvmt Flow	226	3	6	369	6	6

Major/Minor	Major1	Major2	Minor1			
Conflicting Flow All	0	0	229	0	609	228
Stage 1	-	-	-	-	228	-
Stage 2	-	-	-	-	381	-
Critical Hdwy	-	-	4.12	-	6.42	6.22
Critical Hdwy Stg 1	-	-	-	-	5.42	-
Critical Hdwy Stg 2	-	-	-	-	5.42	-
Follow-up Hdwy	-	-	2.218	-	3.518	3.318
Pot Cap-1 Maneuver	-	-	1339	-	458	811
Stage 1	-	-	-	-	810	-
Stage 2	-	-	-	-	691	-
Platoon blocked, %	-	-	-	-	-	-
Mov Cap-1 Maneuver	-	-	1339	-	455	811
Mov Cap-2 Maneuver	-	-	-	-	543	-
Stage 1	-	-	-	-	810	-
Stage 2	-	-	-	-	687	-

Approach	EB	WB	NB
HCM Control Delay, s	0	0.1	10.6
HCM LOS			B

Minor Lane/Major Mvmt	NBLn1	EBT	EBR	WBL	WBT
Capacity (veh/h)	650	-	-	1339	-
HCM Lane V/C Ratio	0.018	-	-	0.004	-
HCM Control Delay (s)	10.6	-	-	7.7	0
HCM Lane LOS	B	-	-	A	A
HCM 95th %tile Q(veh)	0.1	-	-	0	-

HCM 6th TWSC

13: NC 86 (N. Columbia St)/NC 86 (MLK Jr. Blvd) & North Street & N. Columbia Street 09/01/2020

Intersection

Int Delay, s/veh 1.5

Movement	WBL	WBR	NBL	NBT	NBR	SBL	SBT	SBR	SEL	SER
Lane Configurations										
Traffic Vol, veh/h	2	3	38	438	3	9	758	2	6	54
Future Vol, veh/h	2	3	38	438	3	9	758	2	6	54
Conflicting Peds, #/hr	0	0	1	0	15	15	0	1	0	0
Sign Control	Stop	Stop	Free	Free	Free	Free	Free	Free	Stop	Stop
RT Channelized	-	-	-	-	None	-	-	None	-	None
Storage Length	0	-	150	-	-	70	-	-	0	-
Veh in Median Storage, #	0	-	-	0	-	-	0	-	0	-
Grade, %	2	-	-	-5	-	-	5	-	-3	-
Peak Hour Factor	48	48	93	93	93	89	89	89	76	76
Heavy Vehicles, %	10	10	7	7	7	5	5	5	8	8
Mvmt Flow	4	6	41	471	3	10	852	2	8	71

Major/Minor	Minor1	Major1	Major2	Minor2
Conflicting Flow All	1020	252	855	428
Stage 1	570	-	-	874
Stage 2	450	-	-	321
Critical Hdwy	8.1	7.3	4.24	6.76
Critical Hdwy Stg 1	7.1	-	-	6.06
Critical Hdwy Stg 2	7.1	-	-	6.06
Follow-up Hdwy	3.6	3.4	2.27	3.38
Pot Cap-1 Maneuver	161	714	749	579
Stage 1	426	-	-	346
Stage 2	511	-	-	684
Platoon blocked, %				
Mov Cap-1 Maneuver	127	704	748	578
Mov Cap-2 Maneuver	127	-	-	143
Stage 1	397	-	-	327
Stage 2	435	-	-	611

Approach	WB	NB	SB	SE
HCM Control Delay, s	13.7	0.8	0.1	15.7
HCM LOS	B			C

Minor Lane/Major Mvmt	NBL	NBT	NBRWBLn1	SELn1	SBL	SBT	SBR
Capacity (veh/h)	748	-	-	449	417	1035	-
HCM Lane V/C Ratio	0.055	-	-	0.074	0.196	0.01	-
HCM Control Delay (s)	10.1	-	-	13.7	15.7	8.5	-
HCM Lane LOS	B	-	-	B	C	A	-
HCM 95th %tile Q(veh)	0.2	-	-	0.2	0.7	0	-

Intersection						
Int Delay, s/veh	1.8					
Movement	EBL	EBT	WBT	WBR	SBL	SBR
Lane Configurations						
Traffic Vol, veh/h	44	330	239	41	19	27
Future Vol, veh/h	44	330	239	41	19	27
Conflicting Peds, #/hr	16	0	0	16	0	0
Sign Control	Free	Free	Free	Free	Stop	Stop
RT Channelized	-	None	-	None	-	None
Storage Length	125	-	-	-	0	-
Veh in Median Storage, #	-	0	0	-	0	-
Grade, %	-	-3	2	-	0	-
Peak Hour Factor	90	90	90	90	56	56
Heavy Vehicles, %	2	2	2	2	2	2
Mvmt Flow	49	367	266	46	34	48

Major/Minor	Major1	Major2	Minor2		
Conflicting Flow All	328	0	-	0	770
Stage 1	-	-	-	-	305
Stage 2	-	-	-	-	465
Critical Hdwy	4.12	-	-	-	6.42
Critical Hdwy Stg 1	-	-	-	-	5.42
Critical Hdwy Stg 2	-	-	-	-	5.42
Follow-up Hdwy	2.218	-	-	-	3.518
Pot Cap-1 Maneuver	1232	-	-	-	369
Stage 1	-	-	-	-	748
Stage 2	-	-	-	-	632
Platoon blocked, %		-	-	-	
Mov Cap-1 Maneuver	1213	-	-	-	344
Mov Cap-2 Maneuver	-	-	-	-	458
Stage 1	-	-	-	-	708
Stage 2	-	-	-	-	623

Approach	EB	WB	SB
HCM Control Delay, s	1	0	12.2
HCM LOS			B

Minor Lane/Major Mvmt	EBL	EBT	WBT	WBR	SBLn1
Capacity (veh/h)	1213	-	-	-	584
HCM Lane V/C Ratio	0.04	-	-	-	0.141
HCM Control Delay (s)	8.1	-	-	-	12.2
HCM Lane LOS	A	-	-	-	B
HCM 95th %tile Q(veh)	0.1	-	-	-	0.5

Intersection						
Int Delay, s/veh	1.4					
Movement	EBT	EBR	WBL	WBT	NBL	NBR
Lane Configurations						
Traffic Vol, veh/h	309	39	34	264	17	23
Future Vol, veh/h	309	39	34	264	17	23
Conflicting Peds, #/hr	0	12	12	0	0	0
Sign Control	Free	Free	Free	Free	Stop	Stop
RT Channelized	-	None	-	None	-	None
Storage Length	-	-	90	-	0	-
Veh in Median Storage, #	0	-	-	0	0	-
Grade, %	0	-	-	-2	0	-
Peak Hour Factor	90	90	90	90	59	59
Heavy Vehicles, %	2	2	2	2	2	2
Mvmt Flow	343	43	38	293	29	39

Major/Minor	Major1	Major2	Minor1		
Conflicting Flow All	0	0	398	0	746 377
Stage 1	-	-	-	-	377 -
Stage 2	-	-	-	-	369 -
Critical Hdwy	-	-	4.12	-	6.42 6.22
Critical Hdwy Stg 1	-	-	-	-	5.42 -
Critical Hdwy Stg 2	-	-	-	-	5.42 -
Follow-up Hdwy	-	-	2.218	-	3.518 3.318
Pot Cap-1 Maneuver	-	-	1161	-	381 670
Stage 1	-	-	-	-	694 -
Stage 2	-	-	-	-	699 -
Platoon blocked, %	-	-	-	-	-
Mov Cap-1 Maneuver	-	-	1148	-	364 662
Mov Cap-2 Maneuver	-	-	-	-	477 -
Stage 1	-	-	-	-	686 -
Stage 2	-	-	-	-	676 -

Approach	EB	WB	NB
HCM Control Delay, s	0	0.9	12.2
HCM LOS			B

Minor Lane/Major Mvmt	NBLn1	EBT	EBR	WBL	WBT
Capacity (veh/h)	568	-	-	1148	-
HCM Lane V/C Ratio	0.119	-	-	0.033	-
HCM Control Delay (s)	12.2	-	-	8.2	-
HCM Lane LOS	B	-	-	A	-
HCM 95th %tile Q(veh)	0.4	-	-	0.1	-

HCM 6th TWSC
 5: Wallace Parking Deck Exit 2 & E. Rosemary Street

09/01/2020

Intersection						
Int Delay, s/veh	0.8					
Movement	EBT	EBR	WBL	WBT	NBL	NBR
Lane Configurations						
Traffic Vol, veh/h	329	3	1	286	12	26
Future Vol, veh/h	329	3	1	286	12	26
Conflicting Peds, #/hr	0	0	0	0	0	0
Sign Control	Free	Free	Free	Free	Stop	Stop
RT Channelized	-	None	-	None	-	None
Storage Length	-	-	-	-	0	-
Veh in Median Storage, #	0	-	-	0	0	-
Grade, %	2	-	-	-2	0	-
Peak Hour Factor	90	90	90	90	72	72
Heavy Vehicles, %	2	2	2	2	2	2
Mvmt Flow	366	3	1	318	17	36

Major/Minor	Major1	Major2	Minor1		
Conflicting Flow All	0	0	369	0	688 368
Stage 1	-	-	-	-	368 -
Stage 2	-	-	-	-	320 -
Critical Hdwy	-	-	4.12	-	6.42 6.22
Critical Hdwy Stg 1	-	-	-	-	5.42 -
Critical Hdwy Stg 2	-	-	-	-	5.42 -
Follow-up Hdwy	-	-	2.218	-	3.518 3.318
Pot Cap-1 Maneuver	-	-	1190	-	412 677
Stage 1	-	-	-	-	700 -
Stage 2	-	-	-	-	736 -
Platoon blocked, %	-	-	-	-	-
Mov Cap-1 Maneuver	-	-	1190	-	412 677
Mov Cap-2 Maneuver	-	-	-	-	515 -
Stage 1	-	-	-	-	700 -
Stage 2	-	-	-	-	735 -

Approach	EB	WB	NB
HCM Control Delay, s	0	0	11.4
HCM LOS			B

Minor Lane/Major Mvmt	NBLn1	EBT	EBR	WBL	WBT
Capacity (veh/h)	616	-	-	1190	-
HCM Lane V/C Ratio	0.086	-	-	0.001	-
HCM Control Delay (s)	11.4	-	-	8	0
HCM Lane LOS	B	-	-	A	A
HCM 95th %tile Q(veh)	0.3	-	-	0	-

HCM 6th TWSC

13: NC 86 (N. Columbia St)/NC 86 (MLK Jr. Blvd) & North Street & N. Columbia Street 09/01/2020

Intersection

Int Delay, s/veh 2.2

Movement	WBL	WBR	NBL	NBT	NBR	SBL	SBT	SBR	SEL	SER
Lane Configurations										
Traffic Vol, veh/h	8	9	44	470	4	9	538	6	7	59
Future Vol, veh/h	8	9	44	470	4	9	538	6	7	59
Conflicting Peds, #/hr	0	0	6	0	41	41	0	6	0	0
Sign Control	Stop	Stop	Free	Free	Free	Free	Free	Free	Stop	Stop
RT Channelized	-	-	-	-	None	-	-	None	-	None
Storage Length	0	-	150	-	-	70	-	-	0	-
Veh in Median Storage, #	0	-	-	0	-	-	0	-	0	-
Grade, %	2	-	-	-5	-	-	5	-	-3	-
Peak Hour Factor	75	75	93	93	93	87	87	87	75	75
Heavy Vehicles, %	2	2	7	7	7	5	5	5	8	8
Mvmt Flow	11	12	47	505	4	10	618	7	9	79

Major/Minor	Minor1	Major1	Major2	Minor2
Conflicting Flow All	976	304	631	0
Stage 1	642	-	-	-
Stage 2	334	-	-	-
Critical Hdwy	7.94	7.14	4.24	-
Critical Hdwy Stg 1	6.94	-	-	-
Critical Hdwy Stg 2	6.94	-	-	-
Follow-up Hdwy	3.52	3.32	2.27	-
Pot Cap-1 Maneuver	184	680	914	-
Stage 1	399	-	-	-
Stage 2	630	-	-	-
Platoon blocked, %				
Mov Cap-1 Maneuver	143	648	909	-
Mov Cap-2 Maneuver	143	-	-	-
Stage 1	363	-	-	-
Stage 2	540	-	-	-

Approach	WB	NB	SB	SE
HCM Control Delay, s	15.3	0.8	0.1	13.8
HCM LOS	C			B

Minor Lane/Major Mvmt	NBL	NBT	NBRWBLn1	SELn1	SBL	SBT	SBR
Capacity (veh/h)	909	-	-	420	499	956	-
HCM Lane V/C Ratio	0.052	-	-	0.165	0.179	0.011	-
HCM Control Delay (s)	9.2	-	-	15.3	13.8	8.8	-
HCM Lane LOS	A	-	-	C	B	A	-
HCM 95th %tile Q(veh)	0.2	-	-	0.6	0.6	0	-

Intersection						
Int Delay, s/veh	1.5					
Movement	EBL	EBT	WBT	WBR	SBL	SBR
Lane Configurations						
Traffic Vol, veh/h	13	410	280	10	28	53
Future Vol, veh/h	13	410	280	10	28	53
Conflicting Peds, #/hr	16	0	0	16	0	0
Sign Control	Free	Free	Free	Free	Stop	Stop
RT Channelized	-	None	-	None	-	None
Storage Length	125	-	-	-	0	-
Veh in Median Storage, #	-	0	0	-	0	-
Grade, %	-	-3	2	-	0	-
Peak Hour Factor	92	92	92	92	83	83
Heavy Vehicles, %	2	2	2	2	2	2
Mvmt Flow	14	446	304	11	34	64

Major/Minor	Major1	Major2	Minor2		
Conflicting Flow All	331	0	-	0	800 326
Stage 1	-	-	-	-	326 -
Stage 2	-	-	-	-	474 -
Critical Hdwy	4.12	-	-	-	6.42 6.22
Critical Hdwy Stg 1	-	-	-	-	5.42 -
Critical Hdwy Stg 2	-	-	-	-	5.42 -
Follow-up Hdwy	2.218	-	-	-	3.518 3.318
Pot Cap-1 Maneuver	1228	-	-	-	354 715
Stage 1	-	-	-	-	731 -
Stage 2	-	-	-	-	626 -
Platoon blocked, %		-	-	-	
Mov Cap-1 Maneuver	1209	-	-	-	339 704
Mov Cap-2 Maneuver	-	-	-	-	455 -
Stage 1	-	-	-	-	711 -
Stage 2	-	-	-	-	617 -

Approach	EB	WB	SB
HCM Control Delay, s	0.2	0	12.3
HCM LOS			B

Minor Lane/Major Mvmt	EBL	EBT	WBT	WBR	SBLn1
Capacity (veh/h)	1209	-	-	-	592
HCM Lane V/C Ratio	0.012	-	-	-	0.165
HCM Control Delay (s)	8	-	-	-	12.3
HCM Lane LOS	A	-	-	-	B
HCM 95th %tile Q(veh)	0	-	-	-	0.6

Intersection						
Int Delay, s/veh	1.6					
Movement	EBT	EBR	WBL	WBT	NBL	NBR
Lane Configurations						
Traffic Vol, veh/h	414	32	26	266	15	61
Future Vol, veh/h	414	32	26	266	15	61
Conflicting Peds, #/hr	0	12	12	0	0	0
Sign Control	Free	Free	Free	Free	Stop	Stop
RT Channelized	-	None	-	None	-	None
Storage Length	-	-	90	-	0	-
Veh in Median Storage, #	0	-	-	0	0	-
Grade, %	0	-	-	-2	0	-
Peak Hour Factor	92	92	92	92	82	82
Heavy Vehicles, %	2	2	2	2	2	2
Mvmt Flow	450	35	28	289	18	74

Major/Minor	Major1	Major2	Minor1	Minor2	Minor3
Conflicting Flow All	0	0	497	0	825
Stage 1	-	-	-	-	480
Stage 2	-	-	-	-	345
Critical Hdwy	-	-	4.12	-	6.42
Critical Hdwy Stg 1	-	-	-	-	5.42
Critical Hdwy Stg 2	-	-	-	-	5.42
Follow-up Hdwy	-	-	2.218	-	3.518
Pot Cap-1 Maneuver	-	-	1067	-	342
Stage 1	-	-	-	-	622
Stage 2	-	-	-	-	717
Platoon blocked, %	-	-	-	-	-
Mov Cap-1 Maneuver	-	-	1055	-	329
Mov Cap-2 Maneuver	-	-	-	-	447
Stage 1	-	-	-	-	615
Stage 2	-	-	-	-	698

Approach	EB	WB	NB
HCM Control Delay, s	0	0.8	12.9
HCM LOS			B

Minor Lane/Major Mvmt	NBLn1	EBT	EBR	WBL	WBT
Capacity (veh/h)	547	-	-	1055	-
HCM Lane V/C Ratio	0.169	-	-	0.027	-
HCM Control Delay (s)	12.9	-	-	8.5	-
HCM Lane LOS	B	-	-	A	-
HCM 95th %tile Q(veh)	0.6	-	-	0.1	-

HCM 6th TWSC
5: Wallace Parking Deck Exit 2 & E. Rosemary Street

09/01/2020

Intersection						
Int Delay, s/veh	1.1					
Movement	EBT	EBR	WBL	WBT	NBL	NBR
Lane Configurations						
Traffic Vol, veh/h	475	0	3	271	20	35
Future Vol, veh/h	475	0	3	271	20	35
Conflicting Peds, #/hr	0	0	0	0	0	0
Sign Control	Free	Free	Free	Free	Stop	Stop
RT Channelized	-	None	-	None	-	None
Storage Length	-	-	-	-	0	-
Veh in Median Storage, #	0	-	-	0	0	-
Grade, %	2	-	-	-2	0	-
Peak Hour Factor	92	92	92	92	75	75
Heavy Vehicles, %	2	2	2	2	2	2
Mvmt Flow	516	0	3	295	27	47

Major/Minor	Major1	Major2	Minor1		
Conflicting Flow All	0	0	516	0	817
Stage 1	-	-	-	-	516
Stage 2	-	-	-	-	301
Critical Hdwy	-	-	4.12	-	6.42
Critical Hdwy Stg 1	-	-	-	-	5.42
Critical Hdwy Stg 2	-	-	-	-	5.42
Follow-up Hdwy	-	-	2.218	-	3.518
Pot Cap-1 Maneuver	-	-	1050	-	346
Stage 1	-	-	-	-	599
Stage 2	-	-	-	-	751
Platoon blocked, %	-	-	-	-	-
Mov Cap-1 Maneuver	-	-	1050	-	345
Mov Cap-2 Maneuver	-	-	-	-	457
Stage 1	-	-	-	-	599
Stage 2	-	-	-	-	749

Approach	EB	WB	NB
HCM Control Delay, s	0	0.1	13.1
HCM LOS			B

Minor Lane/Major Mvmt	NBLn1	EBT	EBR	WBL	WBT
Capacity (veh/h)	517	-	-	1050	-
HCM Lane V/C Ratio	0.142	-	-	0.003	-
HCM Control Delay (s)	13.1	-	-	8.4	0
HCM Lane LOS	B	-	-	A	A
HCM 95th %tile Q(veh)	0.5	-	-	0	-

HCM 6th TWSC

13: NC 86 (N. Columbia St)/NC 86 (MLK Jr. Blvd) & North Street & N. Columbia Street 09/01/2020

Intersection

Int Delay, s/veh 9.3

Movement	WBL	WBR	NBL	NBT	NBR	SBL	SBT	SBR	SEL	SER
Lane Configurations										
Traffic Vol, veh/h	24	21	49	799	23	26	738	6	5	100
Future Vol, veh/h	24	21	49	799	23	26	738	6	5	100
Conflicting Peds, #/hr	0	0	7	0	32	32	0	7	0	0
Sign Control	Stop	Stop	Free	Free	Free	Free	Free	Free	Stop	Stop
RT Channelized	-	-	-	-	None	-	-	None	-	None
Storage Length	0	-	150	-	-	70	-	-	0	-
Veh in Median Storage, #	0	-	-	0	-	-	0	-	0	-
Grade, %	2	-	-	-5	-	-	5	-	-3	-
Peak Hour Factor	87	87	83	83	83	88	88	88	92	92
Heavy Vehicles, %	2	2	3	3	3	3	3	3	5	5
Mvmt Flow	28	24	59	963	28	30	839	7	5	109

Major/Minor	Minor1	Major1	Major2	Minor2
Conflicting Flow All	1609	536	853	0
Stage 1	1127	-	-	-
Stage 2	482	-	-	-
Critical Hdwy	7.94	7.14	4.16	-
Critical Hdwy Stg 1	6.94	-	-	-
Critical Hdwy Stg 2	6.94	-	-	-
Follow-up Hdwy	3.52	3.32	2.23	-
Pot Cap-1 Maneuver	58	475	776	-
Stage 1	192	-	-	-
Stage 2	506	-	-	-
Platoon blocked, %				
Mov Cap-1 Maneuver	39	457	771	-
Mov Cap-2 Maneuver	39	-	-	-
Stage 1	172	-	-	-
Stage 2	387	-	-	-

Approach	WB	NB	SB	SE
HCM Control Delay, s	119.6	0.6	0.4	24.4
HCM LOS	F			C

Minor Lane/Major Mvmt	NBL	NBT	NBRWBLn1	SELn1	SBL	SBT	SBR
Capacity (veh/h)	771	-	-	126	302	648	-
HCM Lane V/C Ratio	0.077	-	-	0.894	0.392	0.046	-
HCM Control Delay (s)	10.1	-	-	119.6	24.4	10.8	-
HCM Lane LOS	B	-	-	F	C	B	-
HCM 95th %tile Q(veh)	0.2	-	-	5.7	1.8	0.1	-



2022 With Parking Deck – Current Site Plan

HCM 6th TWSC
 3: E. Rosemary Street & Rosemary Deck West Ent/Exit

Intersection						
Int Delay, s/veh	2.1					
Movement	EBL	EBT	WBT	WBR	SBL	SBR
Lane Configurations						
Traffic Vol, veh/h	134	251	226	27	2	12
Future Vol, veh/h	134	251	226	27	2	12
Conflicting Peds, #/hr	16	0	0	16	16	16
Sign Control	Free	Free	Free	Free	Stop	Stop
RT Channelized	-	None	-	None	-	None
Storage Length	75	-	-	-	0	-
Veh in Median Storage, #	-	0	0	-	0	-
Grade, %	-	-3	2	-	0	-
Peak Hour Factor	90	90	90	90	50	50
Heavy Vehicles, %	2	2	2	2	2	2
Mvmt Flow	149	279	251	30	4	24

Major/Minor	Major1	Major2	Minor2		
Conflicting Flow All	297	0	0	875	298
Stage 1	-	-	-	282	-
Stage 2	-	-	-	593	-
Critical Hdwy	4.12	-	-	6.42	6.22
Critical Hdwy Stg 1	-	-	-	5.42	-
Critical Hdwy Stg 2	-	-	-	5.42	-
Follow-up Hdwy	2.218	-	-	3.518	3.318
Pot Cap-1 Maneuver	1264	-	-	320	741
Stage 1	-	-	-	766	-
Stage 2	-	-	-	552	-
Platoon blocked, %		-	-		
Mov Cap-1 Maneuver	1245	-	-	273	719
Mov Cap-2 Maneuver	-	-	-	395	-
Stage 1	-	-	-	664	-
Stage 2	-	-	-	544	-

Approach	EB	WB	SB
HCM Control Delay, s	2.9	0	10.8
HCM LOS			B

Minor Lane/Major Mvmt	EBL	EBT	WBT	WBR	SBLn1
Capacity (veh/h)	1245	-	-	-	644
HCM Lane V/C Ratio	0.12	-	-	-	0.043
HCM Control Delay (s)	8.3	-	-	-	10.8
HCM Lane LOS	A	-	-	-	B
HCM 95th %tile Q(veh)	0.4	-	-	-	0.1

Intersection						
Int Delay, s/veh	1.1					
Movement	EBL	EBT	WBT	WBR	SBL	SBR
Lane Configurations						
Traffic Vol, veh/h	54	199	248	54	5	5
Future Vol, veh/h	54	199	248	54	5	5
Conflicting Peds, #/hr	16	0	0	16	16	16
Sign Control	Free	Free	Free	Free	Stop	Stop
RT Channelized	-	None	-	None	-	None
Storage Length	75	-	-	-	0	-
Veh in Median Storage, #	-	0	0	-	0	-
Grade, %	-	0	2	-	0	-
Peak Hour Factor	90	90	90	90	50	50
Heavy Vehicles, %	2	2	2	2	2	2
Mvmt Flow	60	221	276	60	10	10

Major/Minor	Major1	Major2	Minor2		
Conflicting Flow All	352	0	-	0	679 338
Stage 1	-	-	-	-	322 -
Stage 2	-	-	-	-	357 -
Critical Hdwy	4.12	-	-	-	6.42 6.22
Critical Hdwy Stg 1	-	-	-	-	5.42 -
Critical Hdwy Stg 2	-	-	-	-	5.42 -
Follow-up Hdwy	2.218	-	-	-	3.518 3.318
Pot Cap-1 Maneuver	1207	-	-	-	417 704
Stage 1	-	-	-	-	735 -
Stage 2	-	-	-	-	708 -
Platoon blocked, %		-	-	-	
Mov Cap-1 Maneuver	1189	-	-	-	384 683
Mov Cap-2 Maneuver	-	-	-	-	491 -
Stage 1	-	-	-	-	688 -
Stage 2	-	-	-	-	697 -

Approach	EB	WB	SB
HCM Control Delay, s	1.7	0	11.5
HCM LOS			B

Minor Lane/Major Mvmt	EBL	EBT	WBT	WBR	SBLn1
Capacity (veh/h)	1189	-	-	-	571
HCM Lane V/C Ratio	0.05	-	-	-	0.035
HCM Control Delay (s)	8.2	-	-	-	11.5
HCM Lane LOS	A	-	-	-	B
HCM 95th %tile Q(veh)	0.2	-	-	-	0.1

Intersection

Int Delay, s/veh 1.5

Movement	WBL	WBR	NBL	NBT	NBR	SBL	SBT	SBR	SEL	SER
Lane Configurations										
Traffic Vol, veh/h	2	3	38	440	3	9	801	2	6	54
Future Vol, veh/h	2	3	38	440	3	9	801	2	6	54
Conflicting Peds, #/hr	0	0	1	0	15	15	0	1	0	0
Sign Control	Stop	Stop	Free	Free	Free	Free	Free	Free	Stop	Stop
RT Channelized	-	-	-	-	None	-	-	None	-	None
Storage Length	0	-	150	-	-	70	-	-	0	-
Veh in Median Storage, #	0	-	-	0	-	-	0	-	0	-
Grade, %	2	-	-	-5	-	-	5	-	-3	-
Peak Hour Factor	48	48	93	93	93	89	89	89	76	76
Heavy Vehicles, %	10	10	7	7	7	5	5	5	8	8
Mvmt Flow	4	6	41	473	3	10	900	2	8	71

Major/Minor	Minor1	Major1	Major2	Minor2
Conflicting Flow All	1046	253	903	0
Stage 1	572	-	-	-
Stage 2	474	-	-	-
Critical Hdwy	8.1	7.3	4.24	-
Critical Hdwy Stg 1	7.1	-	-	-
Critical Hdwy Stg 2	7.1	-	-	-
Follow-up Hdwy	3.6	3.4	2.27	-
Pot Cap-1 Maneuver	153	713	718	-
Stage 1	425	-	-	-
Stage 2	493	-	-	-
Platoon blocked, %				
Mov Cap-1 Maneuver	119	703	717	-
Mov Cap-2 Maneuver	119	-	-	-
Stage 1	395	-	-	-
Stage 2	417	-	-	-

Approach	WB	NB	SB	SE
HCM Control Delay, s	13.9	0.8	0.1	16.4
HCM LOS	B			C

Minor Lane/Major Mvmt	NBL	NBT	NBRWBLn1	SELn1	SBL	SBT	SBR
Capacity (veh/h)	717	-	-	436	397	1033	-
HCM Lane V/C Ratio	0.057	-	-	0.076	0.205	0.01	-
HCM Control Delay (s)	10.3	-	-	13.9	16.4	8.5	-
HCM Lane LOS	B	-	-	B	C	A	-
HCM 95th %tile Q(veh)	0.2	-	-	0.2	0.8	0	-

HCM 6th TWSC
 3: E. Rosemary Street & Rosemary Deck Ent/Exit

2022 Build Alternative 1 Noon Peak
 Timing Plan: Noon Peak

Intersection						
Int Delay, s/veh	3.3					
Movement	EBL	EBT	WBT	WBR	SBL	SBR
Lane Configurations						
Traffic Vol, veh/h	106	327	242	21	16	80
Future Vol, veh/h	106	327	242	21	16	80
Conflicting Peds, #/hr	16	0	0	16	0	0
Sign Control	Free	Free	Free	Free	Stop	Stop
RT Channelized	-	None	-	None	-	None
Storage Length	75	-	-	-	0	-
Veh in Median Storage, #	-	0	0	-	0	-
Grade, %	-	-3	2	-	0	-
Peak Hour Factor	90	90	90	90	56	56
Heavy Vehicles, %	2	2	2	2	2	2
Mvmt Flow	118	363	269	23	29	143

Major/Minor	Major1	Major2	Minor2		
Conflicting Flow All	308	0	-	0	896 297
Stage 1	-	-	-	-	297 -
Stage 2	-	-	-	-	599 -
Critical Hdwy	4.12	-	-	-	6.42 6.22
Critical Hdwy Stg 1	-	-	-	-	5.42 -
Critical Hdwy Stg 2	-	-	-	-	5.42 -
Follow-up Hdwy	2.218	-	-	-	3.518 3.318
Pot Cap-1 Maneuver	1253	-	-	-	311 742
Stage 1	-	-	-	-	754 -
Stage 2	-	-	-	-	549 -
Platoon blocked, %		-	-	-	
Mov Cap-1 Maneuver	1234	-	-	-	273 731
Mov Cap-2 Maneuver	-	-	-	-	395 -
Stage 1	-	-	-	-	671 -
Stage 2	-	-	-	-	541 -

Approach	EB	WB	SB
HCM Control Delay, s	2	0	12.7
HCM LOS			B

Minor Lane/Major Mvmt	EBL	EBT	WBT	WBR	SBLn1
Capacity (veh/h)	1234	-	-	-	640
HCM Lane V/C Ratio	0.095	-	-	-	0.268
HCM Control Delay (s)	8.2	-	-	-	12.7
HCM Lane LOS	A	-	-	-	B
HCM 95th %tile Q(veh)	0.3	-	-	-	1.1

Intersection						
Int Delay, s/veh	2.3					
Movement	EBL	EBT	WBT	WBR	SBL	SBR
Lane Configurations						
Traffic Vol, veh/h	42	302	230	42	32	32
Future Vol, veh/h	42	302	230	42	32	32
Conflicting Peds, #/hr	16	0	0	16	0	0
Sign Control	Free	Free	Free	Free	Stop	Stop
RT Channelized	-	None	-	None	-	None
Storage Length	75	-	-	-	0	-
Veh in Median Storage, #	-	0	0	-	0	-
Grade, %	-	0	2	-	0	-
Peak Hour Factor	90	90	90	90	56	56
Heavy Vehicles, %	2	2	2	2	2	2
Mvmt Flow	47	336	256	47	57	57

Major/Minor	Major1	Major2	Minor2		
Conflicting Flow All	319	0	-	0	726 296
Stage 1	-	-	-	-	296 -
Stage 2	-	-	-	-	430 -
Critical Hdwy	4.12	-	-	-	6.42 6.22
Critical Hdwy Stg 1	-	-	-	-	5.42 -
Critical Hdwy Stg 2	-	-	-	-	5.42 -
Follow-up Hdwy	2.218	-	-	-	3.518 3.318
Pot Cap-1 Maneuver	1241	-	-	-	391 743
Stage 1	-	-	-	-	755 -
Stage 2	-	-	-	-	656 -
Platoon blocked, %		-	-	-	
Mov Cap-1 Maneuver	1222	-	-	-	365 732
Mov Cap-2 Maneuver	-	-	-	-	476 -
Stage 1	-	-	-	-	716 -
Stage 2	-	-	-	-	646 -

Approach	EB	WB	SB
HCM Control Delay, s	1	0	12.8
HCM LOS			B

Minor Lane/Major Mvmt	EBL	EBT	WBT	WBR	SBLn1
Capacity (veh/h)	1222	-	-	-	577
HCM Lane V/C Ratio	0.038	-	-	-	0.198
HCM Control Delay (s)	8.1	-	-	-	12.8
HCM Lane LOS	A	-	-	-	B
HCM 95th %tile Q(veh)	0.1	-	-	-	0.7

Intersection

Int Delay, s/veh 2.2

Movement	WBL	WBR	NBL	NBT	NBR	SBL	SBT	SBR	SEL	SER
Lane Configurations										
Traffic Vol, veh/h	8	9	44	494	4	9	567	6	7	59
Future Vol, veh/h	8	9	44	494	4	9	567	6	7	59
Conflicting Peds, #/hr	0	0	6	0	41	41	0	6	0	0
Sign Control	Stop	Stop	Free	Free	Free	Free	Free	Free	Stop	Stop
RT Channelized	-	-	-	-	None	-	-	None	-	None
Storage Length	0	-	150	-	-	70	-	-	0	-
Veh in Median Storage, #	0	-	-	0	-	-	0	-	0	-
Grade, %	2	-	-	-5	-	-	5	-	-3	-
Peak Hour Factor	75	75	93	93	93	87	87	87	75	75
Heavy Vehicles, %	2	2	7	7	7	5	5	5	8	8
Mvmt Flow	11	12	47	531	4	10	652	7	9	79

Major/Minor	Minor1	Major1	Major2	Minor2
Conflicting Flow All	1019	317	665	0
Stage 1	668	-	-	-
Stage 2	351	-	-	-
Critical Hdwy	7.94	7.14	4.24	-
Critical Hdwy Stg 1	6.94	-	-	-
Critical Hdwy Stg 2	6.94	-	-	-
Follow-up Hdwy	3.52	3.32	2.27	-
Pot Cap-1 Maneuver	171	667	887	-
Stage 1	384	-	-	-
Stage 2	614	-	-	-
Platoon blocked, %				
Mov Cap-1 Maneuver	131	636	882	-
Mov Cap-2 Maneuver	131	-	-	-
Stage 1	349	-	-	-
Stage 2	524	-	-	-

Approach	WB	NB	SB	SE
HCM Control Delay, s	15.9	0.8	0.1	14.3
HCM LOS	C			B

Minor Lane/Major Mvmt	NBL	NBT	NBR	WBLn1	SELn1	SBL	SBT	SBR
Capacity (veh/h)	882	-	-	399	477	935	-	-
HCM Lane V/C Ratio	0.054	-	-	0.174	0.187	0.011	-	-
HCM Control Delay (s)	9.3	-	-	15.9	14.3	8.9	-	-
HCM Lane LOS	A	-	-	C	B	A	-	-
HCM 95th %tile Q(veh)	0.2	-	-	0.6	0.7	0	-	-

HCM 6th TWSC
 3: E. Rosemary Street & Rosemary Deck Ent/Exit

Intersection						
Int Delay, s/veh	3.3					
Movement	EBL	EBT	WBT	WBR	SBL	SBR
Lane Configurations						
Traffic Vol, veh/h	54	398	294	11	29	146
Future Vol, veh/h	54	398	294	11	29	146
Conflicting Peds, #/hr	16	0	0	16	0	0
Sign Control	Free	Free	Free	Free	Stop	Stop
RT Channelized	-	None	-	None	-	None
Storage Length	75	-	-	-	0	-
Veh in Median Storage, #	-	0	0	-	0	-
Grade, %	-	-3	2	-	0	-
Peak Hour Factor	92	92	92	92	83	83
Heavy Vehicles, %	2	2	2	2	2	2
Mvmt Flow	59	433	320	12	35	176

Major/Minor	Major1	Major2	Minor2		
Conflicting Flow All	348	0	-	0	893
Stage 1	-	-	-	-	342
Stage 2	-	-	-	-	551
Critical Hdwy	4.12	-	-	-	6.42
Critical Hdwy Stg 1	-	-	-	-	5.42
Critical Hdwy Stg 2	-	-	-	-	5.42
Follow-up Hdwy	2.218	-	-	-	3.518
Pot Cap-1 Maneuver	1211	-	-	-	312
Stage 1	-	-	-	-	719
Stage 2	-	-	-	-	577
Platoon blocked, %		-	-	-	
Mov Cap-1 Maneuver	1193	-	-	-	288
Mov Cap-2 Maneuver	-	-	-	-	411
Stage 1	-	-	-	-	674
Stage 2	-	-	-	-	568

Approach	EB	WB	SB
HCM Control Delay, s	1	0	13.8
HCM LOS			B

Minor Lane/Major Mvmt	EBL	EBT	WBT	WBR	SBLn1
Capacity (veh/h)	1193	-	-	-	620
HCM Lane V/C Ratio	0.049	-	-	-	0.34
HCM Control Delay (s)	8.2	-	-	-	13.8
HCM Lane LOS	A	-	-	-	B
HCM 95th %tile Q(veh)	0.2	-	-	-	1.5

Intersection						
Int Delay, s/veh	2.3					
Movement	EBL	EBT	WBT	WBR	SBL	SBR
Lane Configurations						
Traffic Vol, veh/h	21	405	247	21	58	58
Future Vol, veh/h	21	405	247	21	58	58
Conflicting Peds, #/hr	16	0	0	16	0	0
Sign Control	Free	Free	Free	Free	Stop	Stop
RT Channelized	-	None	-	None	-	None
Storage Length	75	-	-	-	0	-
Veh in Median Storage, #	-	0	0	-	0	-
Grade, %	-	0	2	-	0	-
Peak Hour Factor	92	92	92	92	83	83
Heavy Vehicles, %	2	2	2	2	2	2
Mvmt Flow	23	440	268	23	70	70

Major/Minor	Major1	Major2	Minor2		
Conflicting Flow All	307	0	-	0	782 296
Stage 1	-	-	-	-	296 -
Stage 2	-	-	-	-	486 -
Critical Hdwy	4.12	-	-	-	6.42 6.22
Critical Hdwy Stg 1	-	-	-	-	5.42 -
Critical Hdwy Stg 2	-	-	-	-	5.42 -
Follow-up Hdwy	2.218	-	-	-	3.518 3.318
Pot Cap-1 Maneuver	1254	-	-	-	363 743
Stage 1	-	-	-	-	755 -
Stage 2	-	-	-	-	618 -
Platoon blocked, %		-	-	-	
Mov Cap-1 Maneuver	1235	-	-	-	346 732
Mov Cap-2 Maneuver	-	-	-	-	458 -
Stage 1	-	-	-	-	729 -
Stage 2	-	-	-	-	609 -

Approach	EB	WB	SB
HCM Control Delay, s	0.4	0	13.5
HCM LOS			B

Minor Lane/Major Mvmt	EBL	EBT	WBT	WBR	SBLn1
Capacity (veh/h)	1235	-	-	-	563
HCM Lane V/C Ratio	0.018	-	-	-	0.248
HCM Control Delay (s)	8	-	-	-	13.5
HCM Lane LOS	A	-	-	-	B
HCM 95th %tile Q(veh)	0.1	-	-	-	1

Intersection

Int Delay, s/veh 12.2

Movement	WBL	WBR	NBL	NBT	NBR	SBL	SBT	SBR	SEL	SER
Lane Configurations										
Traffic Vol, veh/h	24	21	49	865	23	26	751	6	5	100
Future Vol, veh/h	24	21	49	865	23	26	751	6	5	100
Conflicting Peds, #/hr	0	0	7	0	32	32	0	7	0	0
Sign Control	Stop	Stop	Free	Free	Free	Free	Free	Free	Stop	Stop
RT Channelized	-	-	-	-	None	-	-	None	-	None
Storage Length	0	-	150	-	-	70	-	-	0	-
Veh in Median Storage, #	0	-	-	0	-	-	0	-	0	-
Grade, %	2	-	-	-5	-	-	5	-	-3	-
Peak Hour Factor	87	87	83	83	83	88	88	88	92	92
Heavy Vehicles, %	2	2	3	3	3	3	3	3	5	5
Mvmt Flow	28	24	59	1042	28	30	853	7	5	109

Major/Minor	Minor1	Major1	Major2	Minor2
Conflicting Flow All	1695	575	867	0
Stage 1	1206	-	-	-
Stage 2	489	-	-	-
Critical Hdwy	7.94	7.14	4.16	-
Critical Hdwy Stg 1	6.94	-	-	-
Critical Hdwy Stg 2	6.94	-	-	-
Follow-up Hdwy	3.52	3.32	2.23	-
Pot Cap-1 Maneuver	50	447	766	-
Stage 1	170	-	-	-
Stage 2	501	-	-	-
Platoon blocked, %				
Mov Cap-1 Maneuver	33	430	761	-
Mov Cap-2 Maneuver	33	-	-	-
Stage 1	152	-	-	-
Stage 2	381	-	-	-

Approach	WB	NB	SB	SE
HCM Control Delay, s	169.7	0.5	0.4	29.6
HCM LOS	F			D

Minor Lane/Major Mvmt	NBL	NBT	NBR	WBLn1	SELn1	SBL	SBT	SBR
Capacity (veh/h)	761	-	-	109	262	604	-	-
HCM Lane V/C Ratio	0.078	-	-	1.033	0.452	0.049	-	-
HCM Control Delay (s)	10.1	-	-	169.7	29.6	11.3	-	-
HCM Lane LOS	B	-	-	F	D	B	-	-
HCM 95th %tile Q(veh)	0.3	-	-	6.7	2.2	0.2	-	-



2022 With Parking Deck – North Street Site Access

HCM 6th TWSC
 5: E. Rosemary Street & E Rosemary Deck

09/01/2020

Intersection						
Int Delay, s/veh	2.1					
Movement	EBL	EBT	WBT	WBR	SBL	SBR
Lane Configurations						
Traffic Vol, veh/h	121	197	221	80	6	11
Future Vol, veh/h	121	197	221	80	6	11
Conflicting Peds, #/hr	16	0	0	16	16	16
Sign Control	Free	Free	Free	Free	Stop	Stop
RT Channelized	-	None	-	None	-	None
Storage Length	150	-	-	-	0	0
Veh in Median Storage, #	-	0	0	-	0	-
Grade, %	-	0	2	-	0	-
Peak Hour Factor	90	90	90	90	50	50
Heavy Vehicles, %	2	2	2	2	2	2
Mvmt Flow	134	219	246	89	12	22

Major/Minor	Major1	Major2	Minor2		
Conflicting Flow All	351	0	-	0	810 323
Stage 1	-	-	-	-	307 -
Stage 2	-	-	-	-	503 -
Critical Hdwy	4.12	-	-	-	6.42 6.22
Critical Hdwy Stg 1	-	-	-	-	5.42 -
Critical Hdwy Stg 2	-	-	-	-	5.42 -
Follow-up Hdwy	2.218	-	-	-	3.518 3.318
Pot Cap-1 Maneuver	1208	-	-	-	349 718
Stage 1	-	-	-	-	746 -
Stage 2	-	-	-	-	607 -
Platoon blocked, %		-	-	-	
Mov Cap-1 Maneuver	1190	-	-	-	300 696
Mov Cap-2 Maneuver	-	-	-	-	421 -
Stage 1	-	-	-	-	652 -
Stage 2	-	-	-	-	598 -

Approach	EB	WB	SB
HCM Control Delay, s	3.2	0	11.5
HCM LOS			B

Minor Lane/Major Mvmt	EBL	EBT	WBT	WBR	SBLn1	SBLn2
Capacity (veh/h)	1190	-	-	-	421	696
HCM Lane V/C Ratio	0.113	-	-	-	0.029	0.032
HCM Control Delay (s)	8.4	-	-	-	13.8	10.3
HCM Lane LOS	A	-	-	-	B	B
HCM 95th %tile Q(veh)	0.4	-	-	-	0.1	0.1

Intersection						
Int Delay, s/veh	0.6					
Movement	EBT	EBR	WBL	WBT	NBL	NBR
Lane Configurations						
Traffic Vol, veh/h	18	67	0	19	6	1
Future Vol, veh/h	18	67	0	19	6	1
Conflicting Peds, #/hr	0	0	0	0	0	0
Sign Control	Free	Free	Free	Free	Stop	Stop
RT Channelized	-	None	-	None	-	None
Storage Length	-	-	-	-	0	-
Veh in Median Storage, #	0	-	-	0	0	-
Grade, %	0	-	-	2	0	-
Peak Hour Factor	92	92	92	92	92	92
Heavy Vehicles, %	2	2	2	2	2	2
Mvmt Flow	20	73	0	21	7	1

Major/Minor	Major1	Major2	Minor1	Minor2	Minor3
Conflicting Flow All	0	0	93	0	78
Stage 1	-	-	-	-	57
Stage 2	-	-	-	-	21
Critical Hdwy	-	-	4.12	-	6.42
Critical Hdwy Stg 1	-	-	-	-	5.42
Critical Hdwy Stg 2	-	-	-	-	5.42
Follow-up Hdwy	-	-	2.218	-	3.518
Pot Cap-1 Maneuver	-	-	1501	-	925
Stage 1	-	-	-	-	966
Stage 2	-	-	-	-	1002
Platoon blocked, %	-	-	-	-	-
Mov Cap-1 Maneuver	-	-	1501	-	925
Mov Cap-2 Maneuver	-	-	-	-	925
Stage 1	-	-	-	-	966
Stage 2	-	-	-	-	1002

Approach	EB	WB	NB
HCM Control Delay, s	0	0	8.9
HCM LOS			A

Minor Lane/Major Mvmt	NBLn1	EBT	EBR	WBL	WBT
Capacity (veh/h)	936	-	-	1501	-
HCM Lane V/C Ratio	0.008	-	-	-	-
HCM Control Delay (s)	8.9	-	-	0	-
HCM Lane LOS	A	-	-	A	-
HCM 95th %tile Q(veh)	0	-	-	0	-

HCM 6th TWSC
4: E. Rosemary Street

09/01/2020

Intersection						
Int Delay, s/veh	3.6					
Movement	EBL	EBT	WBT	WBR	SBL	SBR
Lane Configurations	↙	↑	↘		↙	↘
Traffic Vol, veh/h	95	286	209	63	40	72
Future Vol, veh/h	95	286	209	63	40	72
Conflicting Peds, #/hr	16	0	0	16	0	0
Sign Control	Free	Free	Free	Free	Stop	Stop
RT Channelized	-	None	-	None	-	None
Storage Length	150	-	-	-	0	0
Veh in Median Storage, #	-	0	0	-	0	-
Grade, %	-	0	2	-	0	-
Peak Hour Factor	90	90	90	90	56	56
Heavy Vehicles, %	2	2	2	2	2	2
Mvmt Flow	106	318	232	70	71	129

Major/Minor	Major1	Major2	Minor2		
Conflicting Flow All	318	0	-	0	813 283
Stage 1	-	-	-	-	283 -
Stage 2	-	-	-	-	530 -
Critical Hdwy	4.12	-	-	-	6.42 6.22
Critical Hdwy Stg 1	-	-	-	-	5.42 -
Critical Hdwy Stg 2	-	-	-	-	5.42 -
Follow-up Hdwy	2.218	-	-	-	3.518 3.318
Pot Cap-1 Maneuver	1242	-	-	-	348 756
Stage 1	-	-	-	-	765 -
Stage 2	-	-	-	-	590 -
Platoon blocked, %		-	-	-	
Mov Cap-1 Maneuver	1223	-	-	-	308 744
Mov Cap-2 Maneuver	-	-	-	-	426 -
Stage 1	-	-	-	-	688 -
Stage 2	-	-	-	-	581 -

Approach	EB	WB	SB
HCM Control Delay, s	2	0	12.3
HCM LOS			B

Minor Lane/Major Mvmt	EBL	EBT	WBT	WBR	SBLn1	SBLn2
Capacity (veh/h)	1223	-	-	-	426	744
HCM Lane V/C Ratio	0.086	-	-	-	0.168	0.173
HCM Control Delay (s)	8.2	-	-	-	15.1	10.8
HCM Lane LOS	A	-	-	-	C	B
HCM 95th %tile Q(veh)	0.3	-	-	-	0.6	0.6

Intersection						
Int Delay, s/veh	2.5					
Movement	EBT	EBR	WBL	WBT	NBL	NBR
Lane Configurations						
Traffic Vol, veh/h	20	53	0	61	40	8
Future Vol, veh/h	20	53	0	61	40	8
Conflicting Peds, #/hr	0	0	0	0	0	0
Sign Control	Free	Free	Free	Free	Stop	Stop
RT Channelized	-	None	-	None	-	None
Storage Length	-	-	-	-	0	-
Veh in Median Storage, #	0	-	-	0	0	-
Grade, %	0	-	-	2	0	-
Peak Hour Factor	92	92	92	92	92	92
Heavy Vehicles, %	2	2	2	2	2	2
Mvmt Flow	22	58	0	66	43	9

Major/Minor	Major1	Major2	Minor1	Minor2	Minor3
Conflicting Flow All	0	0	80	0	117
Stage 1	-	-	-	-	51
Stage 2	-	-	-	-	66
Critical Hdwy	-	-	4.12	-	6.42
Critical Hdwy Stg 1	-	-	-	-	5.42
Critical Hdwy Stg 2	-	-	-	-	5.42
Follow-up Hdwy	-	-	2.218	-	3.518
Pot Cap-1 Maneuver	-	-	1518	-	879
Stage 1	-	-	-	-	971
Stage 2	-	-	-	-	957
Platoon blocked, %	-	-	-	-	-
Mov Cap-1 Maneuver	-	-	1518	-	879
Mov Cap-2 Maneuver	-	-	-	-	879
Stage 1	-	-	-	-	971
Stage 2	-	-	-	-	957

Approach	EB	WB	NB
HCM Control Delay, s	0	0	9.3
HCM LOS			A

Minor Lane/Major Mvmt	NBLn1	EBT	EBR	WBL	WBT
Capacity (veh/h)	899	-	-	1518	-
HCM Lane V/C Ratio	0.058	-	-	-	-
HCM Control Delay (s)	9.3	-	-	0	-
HCM Lane LOS	A	-	-	A	-
HCM 95th %tile Q(veh)	0.2	-	-	0	-

HCM 6th TWSC
5: E. Rosemary Street

09/01/2020

Intersection						
Int Delay, s/veh	3.5					
Movement	EBL	EBT	WBT	WBR	SBL	SBR
Lane Configurations	↖	↑	↗		↖	↗
Traffic Vol, veh/h	48	376	236	32	73	131
Future Vol, veh/h	48	376	236	32	73	131
Conflicting Peds, #/hr	16	0	0	16	0	0
Sign Control	Free	Free	Free	Free	Stop	Stop
RT Channelized	-	None	-	None	-	None
Storage Length	150	-	-	-	0	0
Veh in Median Storage, #	-	0	0	-	0	-
Grade, %	-	0	2	-	0	-
Peak Hour Factor	92	92	92	92	83	83
Heavy Vehicles, %	2	2	2	2	2	2
Mvmt Flow	52	409	257	35	88	158

Major/Minor	Major1	Major2	Minor2		
Conflicting Flow All	308	0	-	0	804 291
Stage 1	-	-	-	-	291 -
Stage 2	-	-	-	-	513 -
Critical Hdwy	4.12	-	-	-	6.42 6.22
Critical Hdwy Stg 1	-	-	-	-	5.42 -
Critical Hdwy Stg 2	-	-	-	-	5.42 -
Follow-up Hdwy	2.218	-	-	-	3.518 3.318
Pot Cap-1 Maneuver	1253	-	-	-	352 748
Stage 1	-	-	-	-	759 -
Stage 2	-	-	-	-	601 -
Platoon blocked, %		-	-	-	
Mov Cap-1 Maneuver	1234	-	-	-	327 737
Mov Cap-2 Maneuver	-	-	-	-	442 -
Stage 1	-	-	-	-	716 -
Stage 2	-	-	-	-	592 -

Approach	EB	WB	SB
HCM Control Delay, s	0.9	0	12.6
HCM LOS			B

Minor Lane/Major Mvmt	EBL	EBT	WBT	WBR	SBLn1	SBLn2
Capacity (veh/h)	1234	-	-	-	442	737
HCM Lane V/C Ratio	0.042	-	-	-	0.199	0.214
HCM Control Delay (s)	8	-	-	-	15.2	11.2
HCM Lane LOS	A	-	-	-	C	B
HCM 95th %tile Q(veh)	0.1	-	-	-	0.7	0.8

Intersection						
Int Delay, s/veh	3					
Movement	EBT	EBR	WBL	WBT	NBL	NBR
Lane Configurations						
Traffic Vol, veh/h	54	27	0	120	73	15
Future Vol, veh/h	54	27	0	120	73	15
Conflicting Peds, #/hr	0	0	0	0	0	0
Sign Control	Free	Free	Free	Free	Stop	Stop
RT Channelized	-	None	-	None	-	None
Storage Length	-	-	-	-	0	-
Veh in Median Storage, #	0	-	-	0	0	-
Grade, %	0	-	-	2	0	-
Peak Hour Factor	92	92	92	92	92	92
Heavy Vehicles, %	2	2	2	2	2	2
Mvmt Flow	59	29	0	130	79	16

Major/Minor	Major1	Major2	Minor1		
Conflicting Flow All	0	0	88	0	204 74
Stage 1	-	-	-	-	74 -
Stage 2	-	-	-	-	130 -
Critical Hdwy	-	-	4.12	-	6.42 6.22
Critical Hdwy Stg 1	-	-	-	-	5.42 -
Critical Hdwy Stg 2	-	-	-	-	5.42 -
Follow-up Hdwy	-	-	2.218	-	3.518 3.318
Pot Cap-1 Maneuver	-	-	1508	-	784 988
Stage 1	-	-	-	-	949 -
Stage 2	-	-	-	-	896 -
Platoon blocked, %	-	-	-	-	-
Mov Cap-1 Maneuver	-	-	1508	-	784 988
Mov Cap-2 Maneuver	-	-	-	-	784 -
Stage 1	-	-	-	-	949 -
Stage 2	-	-	-	-	896 -

Approach	EB	WB	NB
HCM Control Delay, s	0	0	10
HCM LOS			B

Minor Lane/Major Mvmt	NBLn1	EBT	EBR	WBL	WBT
Capacity (veh/h)	813	-	-	1508	-
HCM Lane V/C Ratio	0.118	-	-	-	-
HCM Control Delay (s)	10	-	-	0	-
HCM Lane LOS	B	-	-	A	-
HCM 95th %tile Q(veh)	0.4	-	-	0	-



2023 Without Office Building Site

HCM 6th TWSC
5: E. Rosemary Street & E Rosemary Deck

09/01/2020

Intersection						
Int Delay, s/veh	2.1					
Movement	EBL	EBT	WBT	WBR	SBL	SBR
Lane Configurations	↖	↑	↗		↖	↗
Traffic Vol, veh/h	121	199	223	80	6	11
Future Vol, veh/h	121	199	223	80	6	11
Conflicting Peds, #/hr	16	0	0	16	16	16
Sign Control	Free	Free	Free	Free	Stop	Stop
RT Channelized	-	None	-	None	-	None
Storage Length	150	-	-	-	0	0
Veh in Median Storage, #	-	0	0	-	0	-
Grade, %	-	0	2	-	0	-
Peak Hour Factor	90	90	90	90	50	50
Heavy Vehicles, %	2	2	2	2	2	2
Mvmt Flow	134	221	248	89	12	22

Major/Minor	Major1	Major2	Minor2		
Conflicting Flow All	353	0	-	0	814 325
Stage 1	-	-	-	-	309 -
Stage 2	-	-	-	-	505 -
Critical Hdwy	4.12	-	-	-	6.42 6.22
Critical Hdwy Stg 1	-	-	-	-	5.42 -
Critical Hdwy Stg 2	-	-	-	-	5.42 -
Follow-up Hdwy	2.218	-	-	-	3.518 3.318
Pot Cap-1 Maneuver	1206	-	-	-	347 716
Stage 1	-	-	-	-	745 -
Stage 2	-	-	-	-	606 -
Platoon blocked, %		-	-	-	
Mov Cap-1 Maneuver	1188	-	-	-	299 694
Mov Cap-2 Maneuver	-	-	-	-	420 -
Stage 1	-	-	-	-	651 -
Stage 2	-	-	-	-	597 -

Approach	EB	WB	SB
HCM Control Delay, s	3.2	0	11.6
HCM LOS			B

Minor Lane/Major Mvmt	EBL	EBT	WBT	WBR	SBLn1	SBLn2
Capacity (veh/h)	1188	-	-	-	420	694
HCM Lane V/C Ratio	0.113	-	-	-	0.029	0.032
HCM Control Delay (s)	8.4	-	-	-	13.8	10.4
HCM Lane LOS	A	-	-	-	B	B
HCM 95th %tile Q(veh)	0.4	-	-	-	0.1	0.1

Intersection						
Int Delay, s/veh	0.6					
Movement	EBT	EBR	WBL	WBT	NBL	NBR
Lane Configurations						
Traffic Vol, veh/h	18	67	0	19	6	1
Future Vol, veh/h	18	67	0	19	6	1
Conflicting Peds, #/hr	0	0	0	0	0	0
Sign Control	Free	Free	Free	Free	Stop	Stop
RT Channelized	-	None	-	None	-	None
Storage Length	-	-	-	-	0	-
Veh in Median Storage, #	0	-	-	0	0	-
Grade, %	0	-	-	2	0	-
Peak Hour Factor	92	92	92	92	92	92
Heavy Vehicles, %	2	2	2	2	2	2
Mvmt Flow	20	73	0	21	7	1

Major/Minor	Major1	Major2	Minor1	Minor2	Minor3
Conflicting Flow All	0	0	93	0	78
Stage 1	-	-	-	-	57
Stage 2	-	-	-	-	21
Critical Hdwy	-	-	4.12	-	6.42
Critical Hdwy Stg 1	-	-	-	-	5.42
Critical Hdwy Stg 2	-	-	-	-	5.42
Follow-up Hdwy	-	-	2.218	-	3.518
Pot Cap-1 Maneuver	-	-	1501	-	925
Stage 1	-	-	-	-	966
Stage 2	-	-	-	-	1002
Platoon blocked, %	-	-	-	-	-
Mov Cap-1 Maneuver	-	-	1501	-	925
Mov Cap-2 Maneuver	-	-	-	-	925
Stage 1	-	-	-	-	966
Stage 2	-	-	-	-	1002

Approach	EB	WB	NB
HCM Control Delay, s	0	0	8.9
HCM LOS			A

Minor Lane/Major Mvmt	NBLn1	EBT	EBR	WBL	WBT
Capacity (veh/h)	936	-	-	1501	-
HCM Lane V/C Ratio	0.008	-	-	-	-
HCM Control Delay (s)	8.9	-	-	0	-
HCM Lane LOS	A	-	-	A	-
HCM 95th %tile Q(veh)	0	-	-	0	-

HCM 6th TWSC
4: E. Rosemary Street

09/01/2020

Intersection						
Int Delay, s/veh	3.6					
Movement	EBL	EBT	WBT	WBR	SBL	SBR
Lane Configurations	↙	↑	↘		↙	↘
Traffic Vol, veh/h	95	289	211	63	40	72
Future Vol, veh/h	95	289	211	63	40	72
Conflicting Peds, #/hr	16	0	0	16	0	0
Sign Control	Free	Free	Free	Free	Stop	Stop
RT Channelized	-	None	-	None	-	None
Storage Length	150	-	-	-	0	0
Veh in Median Storage, #	-	0	0	-	0	-
Grade, %	-	0	2	-	0	-
Peak Hour Factor	90	90	90	90	56	56
Heavy Vehicles, %	2	2	2	2	2	2
Mvmt Flow	106	321	234	70	71	129

Major/Minor	Major1	Major2	Minor2		
Conflicting Flow All	320	0	-	0	818 285
Stage 1	-	-	-	-	285 -
Stage 2	-	-	-	-	533 -
Critical Hdwy	4.12	-	-	-	6.42 6.22
Critical Hdwy Stg 1	-	-	-	-	5.42 -
Critical Hdwy Stg 2	-	-	-	-	5.42 -
Follow-up Hdwy	2.218	-	-	-	3.518 3.318
Pot Cap-1 Maneuver	1240	-	-	-	346 754
Stage 1	-	-	-	-	763 -
Stage 2	-	-	-	-	588 -
Platoon blocked, %		-	-	-	
Mov Cap-1 Maneuver	1221	-	-	-	307 743
Mov Cap-2 Maneuver	-	-	-	-	425 -
Stage 1	-	-	-	-	686 -
Stage 2	-	-	-	-	579 -

Approach	EB	WB	SB
HCM Control Delay, s	2	0	12.4
HCM LOS			B

Minor Lane/Major Mvmt	EBL	EBT	WBT	WBR	SBLn1	SBLn2
Capacity (veh/h)	1221	-	-	-	425	743
HCM Lane V/C Ratio	0.086	-	-	-	0.168	0.173
HCM Control Delay (s)	8.2	-	-	-	15.2	10.9
HCM Lane LOS	A	-	-	-	C	B
HCM 95th %tile Q(veh)	0.3	-	-	-	0.6	0.6

Intersection						
Int Delay, s/veh	2.4					
Movement	EBT	EBR	WBL	WBT	NBL	NBR
Lane Configurations						
Traffic Vol, veh/h	20	53	0	62	40	8
Future Vol, veh/h	20	53	0	62	40	8
Conflicting Peds, #/hr	0	0	0	0	0	0
Sign Control	Free	Free	Free	Free	Stop	Stop
RT Channelized	-	None	-	None	-	None
Storage Length	-	-	-	-	0	-
Veh in Median Storage, #	0	-	-	0	0	-
Grade, %	0	-	-	2	0	-
Peak Hour Factor	92	92	92	92	92	92
Heavy Vehicles, %	2	2	2	2	2	2
Mvmt Flow	22	58	0	67	43	9

Major/Minor	Major1	Major2	Minor1		
Conflicting Flow All	0	0	80	0	118 51
Stage 1	-	-	-	-	51 -
Stage 2	-	-	-	-	67 -
Critical Hdwy	-	-	4.12	-	6.42 6.22
Critical Hdwy Stg 1	-	-	-	-	5.42 -
Critical Hdwy Stg 2	-	-	-	-	5.42 -
Follow-up Hdwy	-	-	2.218	-	3.518 3.318
Pot Cap-1 Maneuver	-	-	1518	-	878 1017
Stage 1	-	-	-	-	971 -
Stage 2	-	-	-	-	956 -
Platoon blocked, %	-	-	-	-	-
Mov Cap-1 Maneuver	-	-	1518	-	878 1017
Mov Cap-2 Maneuver	-	-	-	-	878 -
Stage 1	-	-	-	-	971 -
Stage 2	-	-	-	-	956 -

Approach	EB	WB	NB
HCM Control Delay, s	0	0	9.3
HCM LOS			A

Minor Lane/Major Mvmt	NBLn1	EBT	EBR	WBL	WBT
Capacity (veh/h)	898	-	-	1518	-
HCM Lane V/C Ratio	0.058	-	-	-	-
HCM Control Delay (s)	9.3	-	-	0	-
HCM Lane LOS	A	-	-	A	-
HCM 95th %tile Q(veh)	0.2	-	-	0	-

HCM 6th TWSC
5: E. Rosemary Street

09/01/2020

Intersection						
Int Delay, s/veh	3.5					
Movement	EBL	EBT	WBT	WBR	SBL	SBR
Lane Configurations	↖	↗	↖		↖	↗
Traffic Vol, veh/h	48	380	238	32	73	131
Future Vol, veh/h	48	380	238	32	73	131
Conflicting Peds, #/hr	16	0	0	16	0	0
Sign Control	Free	Free	Free	Free	Stop	Stop
RT Channelized	-	None	-	None	-	None
Storage Length	150	-	-	-	0	0
Veh in Median Storage, #	-	0	0	-	0	-
Grade, %	-	0	2	-	0	-
Peak Hour Factor	92	92	92	92	83	83
Heavy Vehicles, %	2	2	2	2	2	2
Mvmt Flow	52	413	259	35	88	158

Major/Minor	Major1	Major2	Minor2		
Conflicting Flow All	310	0	-	0	810 293
Stage 1	-	-	-	-	293 -
Stage 2	-	-	-	-	517 -
Critical Hdwy	4.12	-	-	-	6.42 6.22
Critical Hdwy Stg 1	-	-	-	-	5.42 -
Critical Hdwy Stg 2	-	-	-	-	5.42 -
Follow-up Hdwy	2.218	-	-	-	3.518 3.318
Pot Cap-1 Maneuver	1250	-	-	-	349 746
Stage 1	-	-	-	-	757 -
Stage 2	-	-	-	-	598 -
Platoon blocked, %		-	-	-	
Mov Cap-1 Maneuver	1231	-	-	-	324 735
Mov Cap-2 Maneuver	-	-	-	-	440 -
Stage 1	-	-	-	-	715 -
Stage 2	-	-	-	-	589 -

Approach	EB	WB	SB
HCM Control Delay, s	0.9	0	12.6
HCM LOS			B

Minor Lane/Major Mvmt	EBL	EBT	WBT	WBR	SBLn1	SBLn2
Capacity (veh/h)	1231	-	-	-	440	735
HCM Lane V/C Ratio	0.042	-	-	-	0.2	0.215
HCM Control Delay (s)	8.1	-	-	-	15.2	11.2
HCM Lane LOS	A	-	-	-	C	B
HCM 95th %tile Q(veh)	0.1	-	-	-	0.7	0.8

Intersection						
Int Delay, s/veh	3					
Movement	EBT	EBR	WBL	WBT	NBL	NBR
Lane Configurations						
Traffic Vol, veh/h	55	27	0	121	73	15
Future Vol, veh/h	55	27	0	121	73	15
Conflicting Peds, #/hr	0	0	0	0	0	0
Sign Control	Free	Free	Free	Free	Stop	Stop
RT Channelized	-	None	-	None	-	None
Storage Length	-	-	-	-	0	-
Veh in Median Storage, #	0	-	-	0	0	-
Grade, %	0	-	-	2	0	-
Peak Hour Factor	92	92	92	92	92	92
Heavy Vehicles, %	2	2	2	2	2	2
Mvmt Flow	60	29	0	132	79	16

Major/Minor	Major1	Major2	Minor1	Minor2	Minor3
Conflicting Flow All	0	0	89	0	207
Stage 1	-	-	-	-	75
Stage 2	-	-	-	-	132
Critical Hdwy	-	-	4.12	-	6.42
Critical Hdwy Stg 1	-	-	-	-	5.42
Critical Hdwy Stg 2	-	-	-	-	5.42
Follow-up Hdwy	-	-	2.218	-	3.518
Pot Cap-1 Maneuver	-	-	1506	-	781
Stage 1	-	-	-	-	948
Stage 2	-	-	-	-	894
Platoon blocked, %	-	-	-	-	-
Mov Cap-1 Maneuver	-	-	1506	-	781
Mov Cap-2 Maneuver	-	-	-	-	781
Stage 1	-	-	-	-	948
Stage 2	-	-	-	-	894

Approach	EB	WB	NB
HCM Control Delay, s	0	0	10
HCM LOS			B

Minor Lane/Major Mvmt	NBLn1	EBT	EBR	WBL	WBT
Capacity (veh/h)	810	-	-	1506	-
HCM Lane V/C Ratio	0.118	-	-	-	-
HCM Control Delay (s)	10	-	-	0	-
HCM Lane LOS	B	-	-	A	-
HCM 95th %tile Q(veh)	0.4	-	-	0	-



2023 With Office Building Site

HCM 6th TWSC
 5: E. Rosemary Street & E Rosemary Deck

09/01/2020

Intersection						
Int Delay, s/veh	1.9					
Movement	EBL	EBT	WBT	WBR	SBL	SBR
Lane Configurations	↖	↑	↗		↖	↗
Traffic Vol, veh/h	121	271	233	80	6	11
Future Vol, veh/h	121	271	233	80	6	11
Conflicting Peds, #/hr	16	0	0	16	16	16
Sign Control	Free	Free	Free	Free	Stop	Stop
RT Channelized	-	None	-	None	-	None
Storage Length	150	-	-	-	0	0
Veh in Median Storage, #	-	0	0	-	0	-
Grade, %	-	0	2	-	0	-
Peak Hour Factor	90	90	90	90	50	50
Heavy Vehicles, %	2	2	2	2	2	2
Mvmt Flow	134	301	259	89	12	22

Major/Minor	Major1	Major2	Minor2		
Conflicting Flow All	364	0	-	0	905 336
Stage 1	-	-	-	-	320 -
Stage 2	-	-	-	-	585 -
Critical Hdwy	4.12	-	-	-	6.42 6.22
Critical Hdwy Stg 1	-	-	-	-	5.42 -
Critical Hdwy Stg 2	-	-	-	-	5.42 -
Follow-up Hdwy	2.218	-	-	-	3.518 3.318
Pot Cap-1 Maneuver	1195	-	-	-	307 706
Stage 1	-	-	-	-	736 -
Stage 2	-	-	-	-	557 -
Platoon blocked, %		-	-	-	
Mov Cap-1 Maneuver	1177	-	-	-	264 685
Mov Cap-2 Maneuver	-	-	-	-	264 -
Stage 1	-	-	-	-	643 -
Stage 2	-	-	-	-	549 -

Approach	EB	WB	SB
HCM Control Delay, s	2.6	0	13.5
HCM LOS			B

Minor Lane/Major Mvmt	EBL	EBT	WBT	WBR	SBLn1	SBLn2
Capacity (veh/h)	1177	-	-	-	264	685
HCM Lane V/C Ratio	0.114	-	-	-	0.045	0.032
HCM Control Delay (s)	8.5	-	-	-	19.3	10.4
HCM Lane LOS	A	-	-	-	C	B
HCM 95th %tile Q(veh)	0.4	-	-	-	0.1	0.1

HCM 6th TWSC
18: E Rosemary Deck & North Street

09/01/2020

Intersection						
Int Delay, s/veh	0.6					
Movement	EBT	EBR	WBL	WBT	NBL	NBR
Lane Configurations						
Traffic Vol, veh/h	18	67	0	19	6	1
Future Vol, veh/h	18	67	0	19	6	1
Conflicting Peds, #/hr	0	0	0	0	0	0
Sign Control	Free	Free	Free	Free	Stop	Stop
RT Channelized	-	None	-	None	-	None
Storage Length	-	-	-	-	0	-
Veh in Median Storage, #	0	-	-	0	0	-
Grade, %	0	-	-	2	0	-
Peak Hour Factor	92	92	92	92	92	92
Heavy Vehicles, %	2	2	2	2	2	2
Mvmt Flow	20	73	0	21	7	1

Major/Minor	Major1	Major2	Minor1	Minor2	Minor3
Conflicting Flow All	0	0	93	0	78
Stage 1	-	-	-	-	57
Stage 2	-	-	-	-	21
Critical Hdwy	-	-	4.12	-	6.42
Critical Hdwy Stg 1	-	-	-	-	5.42
Critical Hdwy Stg 2	-	-	-	-	5.42
Follow-up Hdwy	-	-	2.218	-	3.518
Pot Cap-1 Maneuver	-	-	1501	-	925
Stage 1	-	-	-	-	966
Stage 2	-	-	-	-	1002
Platoon blocked, %	-	-	-	-	-
Mov Cap-1 Maneuver	-	-	1501	-	925
Mov Cap-2 Maneuver	-	-	-	-	925
Stage 1	-	-	-	-	966
Stage 2	-	-	-	-	1002

Approach	EB	WB	NB
HCM Control Delay, s	0	0	8.9
HCM LOS			A

Minor Lane/Major Mvmt	NBLn1	EBT	EBR	WBL	WBT
Capacity (veh/h)	936	-	-	1501	-
HCM Lane V/C Ratio	0.008	-	-	-	-
HCM Control Delay (s)	8.9	-	-	0	-
HCM Lane LOS	A	-	-	A	-
HCM 95th %tile Q(veh)	0	-	-	0	-

HCM 6th TWSC
 39: Office West Driveway & E. Rosemary Street

09/01/2020

Intersection						
Int Delay, s/veh	0.5					
Movement	EBT	EBR	WBL	WBT	NBL	NBR
Lane Configurations						
Traffic Vol, veh/h	229	48	18	307	6	2
Future Vol, veh/h	229	48	18	307	6	2
Conflicting Peds, #/hr	0	0	0	0	0	0
Sign Control	Free	Free	Free	Free	Stop	Stop
RT Channelized	-	None	-	None	-	None
Storage Length	-	-	100	-	0	-
Veh in Median Storage, #	0	-	-	0	0	-
Grade, %	0	-	-	2	0	-
Peak Hour Factor	92	92	92	92	50	50
Heavy Vehicles, %	2	2	2	2	2	2
Mvmt Flow	249	52	20	334	12	4

Major/Minor	Major1	Major2	Minor1			
Conflicting Flow All	0	0	301	0	649	275
Stage 1	-	-	-	-	275	-
Stage 2	-	-	-	-	374	-
Critical Hdwy	-	-	4.12	-	6.42	6.22
Critical Hdwy Stg 1	-	-	-	-	5.42	-
Critical Hdwy Stg 2	-	-	-	-	5.42	-
Follow-up Hdwy	-	-	2.218	-	3.518	3.318
Pot Cap-1 Maneuver	-	-	1260	-	434	764
Stage 1	-	-	-	-	771	-
Stage 2	-	-	-	-	696	-
Platoon blocked, %	-	-	-	-	-	-
Mov Cap-1 Maneuver	-	-	1260	-	427	764
Mov Cap-2 Maneuver	-	-	-	-	427	-
Stage 1	-	-	-	-	771	-
Stage 2	-	-	-	-	685	-

Approach	EB	WB	NB
HCM Control Delay, s	0	0.4	12.8
HCM LOS			B

Minor Lane/Major Mvmt	NBLn1	EBT	EBR	WBL	WBT
Capacity (veh/h)	480	-	-	1260	-
HCM Lane V/C Ratio	0.033	-	-	0.016	-
HCM Control Delay (s)	12.8	-	-	7.9	-
HCM Lane LOS	B	-	-	A	-
HCM 95th %tile Q(veh)	0.1	-	-	0	-

HCM 6th TWSC
 40: Office East Driveway & E. Rosemary Street

09/01/2020

Intersection						
Int Delay, s/veh	0.6					
Movement	EBT	EBR	WBL	WBT	NBL	NBR
Lane Configurations	↶		↷	↶	↷	
Traffic Vol, veh/h	207	24	30	322	3	4
Future Vol, veh/h	207	24	30	322	3	4
Conflicting Peds, #/hr	0	0	0	0	0	0
Sign Control	Free	Free	Free	Free	Stop	Stop
RT Channelized	-	None	-	None	-	None
Storage Length	-	-	65	-	0	-
Veh in Median Storage, #	0	-	-	0	0	-
Grade, %	0	-	-	2	0	-
Peak Hour Factor	92	92	92	92	50	50
Heavy Vehicles, %	2	2	2	2	2	2
Mvmt Flow	225	26	33	350	6	8

Major/Minor	Major1	Major2	Minor1		
Conflicting Flow All	0	0	251	0	654 238
Stage 1	-	-	-	-	238 -
Stage 2	-	-	-	-	416 -
Critical Hdwy	-	-	4.12	-	6.42 6.22
Critical Hdwy Stg 1	-	-	-	-	5.42 -
Critical Hdwy Stg 2	-	-	-	-	5.42 -
Follow-up Hdwy	-	-	2.218	-	3.518 3.318
Pot Cap-1 Maneuver	-	-	1314	-	431 801
Stage 1	-	-	-	-	802 -
Stage 2	-	-	-	-	666 -
Platoon blocked, %	-	-	-	-	-
Mov Cap-1 Maneuver	-	-	1314	-	420 801
Mov Cap-2 Maneuver	-	-	-	-	514 -
Stage 1	-	-	-	-	802 -
Stage 2	-	-	-	-	649 -

Approach	EB	WB	NB
HCM Control Delay, s	0	0.7	10.7
HCM LOS			B

Minor Lane/Major Mvmt	NBLn1	EBT	EBR	WBL	WBT
Capacity (veh/h)	646	-	-	1314	-
HCM Lane V/C Ratio	0.022	-	-	0.025	-
HCM Control Delay (s)	10.7	-	-	7.8	-
HCM Lane LOS	B	-	-	A	-
HCM 95th %tile Q(veh)	0.1	-	-	0.1	-

Intersection						
Int Delay, s/veh	3.5					
Movement	EBL	EBT	WBT	WBR	SBL	SBR
Lane Configurations						
Traffic Vol, veh/h	95	324	241	63	40	72
Future Vol, veh/h	95	324	241	63	40	72
Conflicting Peds, #/hr	16	0	0	16	0	0
Sign Control	Free	Free	Free	Free	Stop	Stop
RT Channelized	-	None	-	None	-	None
Storage Length	150	-	-	-	0	0
Veh in Median Storage, #	-	0	0	-	0	-
Grade, %	-	0	2	-	0	-
Peak Hour Factor	90	90	90	90	56	56
Heavy Vehicles, %	2	2	2	2	2	2
Mvmt Flow	106	360	268	70	71	129

Major/Minor	Major1	Major2	Minor2		
Conflicting Flow All	354	0	-	0	891 319
Stage 1	-	-	-	-	319 -
Stage 2	-	-	-	-	572 -
Critical Hdwy	4.12	-	-	-	6.42 6.22
Critical Hdwy Stg 1	-	-	-	-	5.42 -
Critical Hdwy Stg 2	-	-	-	-	5.42 -
Follow-up Hdwy	2.218	-	-	-	3.518 3.318
Pot Cap-1 Maneuver	1205	-	-	-	313 722
Stage 1	-	-	-	-	737 -
Stage 2	-	-	-	-	565 -
Platoon blocked, %		-	-	-	
Mov Cap-1 Maneuver	1187	-	-	-	277 711
Mov Cap-2 Maneuver	-	-	-	-	401 -
Stage 1	-	-	-	-	661 -
Stage 2	-	-	-	-	557 -

Approach	EB	WB	SB
HCM Control Delay, s	1.9	0	12.9
HCM LOS			B

Minor Lane/Major Mvmt	EBL	EBT	WBT	WBR	SBLn1	SBLn2
Capacity (veh/h)	1187	-	-	-	401	711
HCM Lane V/C Ratio	0.089	-	-	-	0.178	0.181
HCM Control Delay (s)	8.3	-	-	-	15.9	11.2
HCM Lane LOS	A	-	-	-	C	B
HCM 95th %tile Q(veh)	0.3	-	-	-	0.6	0.7

HCM 6th TWSC
 18: E Rosemary Deck & North Street

09/01/2020

Intersection						
Int Delay, s/veh	2.4					
Movement	EBT	EBR	WBL	WBT	NBL	NBR
Lane Configurations						
Traffic Vol, veh/h	20	53	0	62	40	8
Future Vol, veh/h	20	53	0	62	40	8
Conflicting Peds, #/hr	0	0	0	0	0	0
Sign Control	Free	Free	Free	Free	Stop	Stop
RT Channelized	-	None	-	None	-	None
Storage Length	-	-	-	-	0	-
Veh in Median Storage, #	0	-	-	0	0	-
Grade, %	0	-	-	2	0	-
Peak Hour Factor	92	92	92	92	92	92
Heavy Vehicles, %	2	2	2	2	2	2
Mvmt Flow	22	58	0	67	43	9

Major/Minor	Major1	Major2	Minor1		
Conflicting Flow All	0	0	80	0	118
Stage 1	-	-	-	-	51
Stage 2	-	-	-	-	67
Critical Hdwy	-	-	4.12	-	6.42
Critical Hdwy Stg 1	-	-	-	-	5.42
Critical Hdwy Stg 2	-	-	-	-	5.42
Follow-up Hdwy	-	-	2.218	-	3.518
Pot Cap-1 Maneuver	-	-	1518	-	878
Stage 1	-	-	-	-	971
Stage 2	-	-	-	-	956
Platoon blocked, %	-	-	-	-	-
Mov Cap-1 Maneuver	-	-	1518	-	878
Mov Cap-2 Maneuver	-	-	-	-	878
Stage 1	-	-	-	-	971
Stage 2	-	-	-	-	956

Approach	EB	WB	NB
HCM Control Delay, s	0	0	9.3
HCM LOS			A

Minor Lane/Major Mvmt	NBLn1	EBT	EBR	WBL	WBT
Capacity (veh/h)	898	-	-	1518	-
HCM Lane V/C Ratio	0.058	-	-	-	-
HCM Control Delay (s)	9.3	-	-	0	-
HCM Lane LOS	A	-	-	A	-
HCM 95th %tile Q(veh)	0.2	-	-	0	-

HCM 6th TWSC
 39: Office West Driveway & E. Rosemary Street

09/01/2020

Intersection						
Int Delay, s/veh	0.7					
Movement	EBT	EBR	WBL	WBT	NBL	NBR
Lane Configurations	↔		↔	↑	↔	
Traffic Vol, veh/h	342	21	8	286	18	7
Future Vol, veh/h	342	21	8	286	18	7
Conflicting Peds, #/hr	0	0	0	0	0	0
Sign Control	Free	Free	Free	Free	Stop	Stop
RT Channelized	-	None	-	None	-	None
Storage Length	-	-	100	-	0	-
Veh in Median Storage, #	0	-	-	0	0	-
Grade, %	0	-	-	2	0	-
Peak Hour Factor	92	92	92	92	59	100
Heavy Vehicles, %	2	2	2	2	2	2
Mvmt Flow	372	23	9	311	31	7

Major/Minor	Major1	Major2	Minor1		
Conflicting Flow All	0	0	395	0	713 384
Stage 1	-	-	-	-	384 -
Stage 2	-	-	-	-	329 -
Critical Hdwy	-	-	4.12	-	6.42 6.22
Critical Hdwy Stg 1	-	-	-	-	5.42 -
Critical Hdwy Stg 2	-	-	-	-	5.42 -
Follow-up Hdwy	-	-	2.218	-	3.518 3.318
Pot Cap-1 Maneuver	-	-	1164	-	398 664
Stage 1	-	-	-	-	688 -
Stage 2	-	-	-	-	729 -
Platoon blocked, %	-	-	-	-	-
Mov Cap-1 Maneuver	-	-	1164	-	395 664
Mov Cap-2 Maneuver	-	-	-	-	502 -
Stage 1	-	-	-	-	688 -
Stage 2	-	-	-	-	723 -

Approach	EB	WB	NB
HCM Control Delay, s	0	0.2	12.4
HCM LOS			B

Minor Lane/Major Mvmt	NBLn1	EBT	EBR	WBL	WBT
Capacity (veh/h)	526	-	-	1164	-
HCM Lane V/C Ratio	0.071	-	-	0.007	-
HCM Control Delay (s)	12.4	-	-	8.1	-
HCM Lane LOS	B	-	-	A	-
HCM 95th %tile Q(veh)	0.2	-	-	0	-

HCM 6th TWSC
40: Office East Driveway & E. Rosemary Street

09/01/2020

Intersection						
Int Delay, s/veh	0.6					
Movement	EBT	EBR	WBL	WBT	NBL	NBR
Lane Configurations						
Traffic Vol, veh/h	336	13	11	283	11	9
Future Vol, veh/h	336	13	11	283	11	9
Conflicting Peds, #/hr	0	0	0	0	0	0
Sign Control	Free	Free	Free	Free	Stop	Stop
RT Channelized	-	None	-	None	-	None
Storage Length	-	-	65	-	0	-
Veh in Median Storage, #	0	-	-	0	0	-
Grade, %	0	-	-	2	0	-
Peak Hour Factor	92	92	92	92	72	72
Heavy Vehicles, %	2	2	2	2	2	2
Mvmt Flow	365	14	12	308	15	13

Major/Minor	Major1	Major2	Minor1		
Conflicting Flow All	0	0	379	0	704 372
Stage 1	-	-	-	-	372 -
Stage 2	-	-	-	-	332 -
Critical Hdwy	-	-	4.12	-	6.42 6.22
Critical Hdwy Stg 1	-	-	-	-	5.42 -
Critical Hdwy Stg 2	-	-	-	-	5.42 -
Follow-up Hdwy	-	-	2.218	-	3.518 3.318
Pot Cap-1 Maneuver	-	-	1179	-	403 674
Stage 1	-	-	-	-	697 -
Stage 2	-	-	-	-	727 -
Platoon blocked, %	-	-	-	-	-
Mov Cap-1 Maneuver	-	-	1179	-	399 674
Mov Cap-2 Maneuver	-	-	-	-	505 -
Stage 1	-	-	-	-	697 -
Stage 2	-	-	-	-	720 -

Approach	EB	WB	NB
HCM Control Delay, s	0	0.3	11.7
HCM LOS			B

Minor Lane/Major Mvmt	NBLn1	EBT	EBR	WBL	WBT
Capacity (veh/h)	569	-	-	1179	-
HCM Lane V/C Ratio	0.049	-	-	0.01	-
HCM Control Delay (s)	11.7	-	-	8.1	-
HCM Lane LOS	B	-	-	A	-
HCM 95th %tile Q(veh)	0.2	-	-	0	-

HCM 6th TWSC
 5: E. Rosemary Street & E Rosemary Deck

09/01/2020

Intersection						
Int Delay, s/veh	3.4					
Movement	EBL	EBT	WBT	WBR	SBL	SBR
Lane Configurations	↔	↑	↔		↔	↔
Traffic Vol, veh/h	48	395	306	32	73	131
Future Vol, veh/h	48	395	306	32	73	131
Conflicting Peds, #/hr	16	0	0	16	0	0
Sign Control	Free	Free	Free	Free	Stop	Stop
RT Channelized	-	None	-	None	-	None
Storage Length	150	-	-	-	0	0
Veh in Median Storage, #	-	0	0	-	0	-
Grade, %	-	0	2	-	0	-
Peak Hour Factor	92	92	92	92	83	83
Heavy Vehicles, %	2	2	2	2	2	2
Mvmt Flow	52	429	333	35	88	158

Major/Minor	Major1	Major2	Minor2		
Conflicting Flow All	384	0	-	0	900
Stage 1	-	-	-	-	367
Stage 2	-	-	-	-	533
Critical Hdwy	4.12	-	-	-	6.42
Critical Hdwy Stg 1	-	-	-	-	5.42
Critical Hdwy Stg 2	-	-	-	-	5.42
Follow-up Hdwy	2.218	-	-	-	3.518
Pot Cap-1 Maneuver	1174	-	-	-	309
Stage 1	-	-	-	-	701
Stage 2	-	-	-	-	588
Platoon blocked, %		-	-	-	
Mov Cap-1 Maneuver	1156	-	-	-	286
Mov Cap-2 Maneuver	-	-	-	-	411
Stage 1	-	-	-	-	660
Stage 2	-	-	-	-	579

Approach	EB	WB	SB
HCM Control Delay, s	0.9	0	13.5
HCM LOS			B

Minor Lane/Major Mvmt	EBL	EBT	WBT	WBR	SBLn1	SBLn2
Capacity (veh/h)	1156	-	-	-	411	668
HCM Lane V/C Ratio	0.045	-	-	-	0.214	0.236
HCM Control Delay (s)	8.3	-	-	-	16.1	12
HCM Lane LOS	A	-	-	-	C	B
HCM 95th %tile Q(veh)	0.1	-	-	-	0.8	0.9

HCM 6th TWSC
 18: E Rosemary Deck & North Street

09/01/2020

Intersection						
Int Delay, s/veh	3					
Movement	EBT	EBR	WBL	WBT	NBL	NBR
Lane Configurations						
Traffic Vol, veh/h	55	27	0	121	73	15
Future Vol, veh/h	55	27	0	121	73	15
Conflicting Peds, #/hr	0	0	0	0	0	0
Sign Control	Free	Free	Free	Free	Stop	Stop
RT Channelized	-	None	-	None	-	None
Storage Length	-	-	-	-	0	-
Veh in Median Storage, #	0	-	-	0	0	-
Grade, %	0	-	-	2	0	-
Peak Hour Factor	92	92	92	92	92	92
Heavy Vehicles, %	2	2	2	2	2	2
Mvmt Flow	60	29	0	132	79	16

Major/Minor	Major1	Major2	Minor1		
Conflicting Flow All	0	0	89	0	207
Stage 1	-	-	-	-	75
Stage 2	-	-	-	-	132
Critical Hdwy	-	-	4.12	-	6.42
Critical Hdwy Stg 1	-	-	-	-	5.42
Critical Hdwy Stg 2	-	-	-	-	5.42
Follow-up Hdwy	-	-	2.218	-	3.518
Pot Cap-1 Maneuver	-	-	1506	-	781
Stage 1	-	-	-	-	948
Stage 2	-	-	-	-	894
Platoon blocked, %	-	-	-	-	-
Mov Cap-1 Maneuver	-	-	1506	-	781
Mov Cap-2 Maneuver	-	-	-	-	781
Stage 1	-	-	-	-	948
Stage 2	-	-	-	-	894

Approach	EB	WB	NB
HCM Control Delay, s	0	0	10
HCM LOS			B

Minor Lane/Major Mvmt	NBLn1	EBT	EBR	WBL	WBT
Capacity (veh/h)	810	-	-	1506	-
HCM Lane V/C Ratio	0.118	-	-	-	-
HCM Control Delay (s)	10	-	-	0	-
HCM Lane LOS	B	-	-	A	-
HCM 95th %tile Q(veh)	0.4	-	-	0	-

HCM 6th TWSC
 39: Office West Driveway & E. Rosemary Street

09/01/2020

Intersection						
Int Delay, s/veh	1.1					
Movement	EBT	EBR	WBL	WBT	NBL	NBR
Lane Configurations						
Traffic Vol, veh/h	461	9	3	297	42	16
Future Vol, veh/h	461	9	3	297	42	16
Conflicting Peds, #/hr	0	0	0	0	0	0
Sign Control	Free	Free	Free	Free	Stop	Stop
RT Channelized	-	None	-	None	-	None
Storage Length	-	-	100	-	0	-
Veh in Median Storage, #	0	-	-	0	0	-
Grade, %	0	-	-	2	0	-
Peak Hour Factor	92	92	92	92	82	82
Heavy Vehicles, %	2	2	2	2	2	2
Mvmt Flow	501	10	3	323	51	20

Major/Minor	Major1	Major2	Minor1		
Conflicting Flow All	0	0	511	0	835 506
Stage 1	-	-	-	-	506 -
Stage 2	-	-	-	-	329 -
Critical Hdwy	-	-	4.12	-	6.42 6.22
Critical Hdwy Stg 1	-	-	-	-	5.42 -
Critical Hdwy Stg 2	-	-	-	-	5.42 -
Follow-up Hdwy	-	-	2.218	-	3.518 3.318
Pot Cap-1 Maneuver	-	-	1054	-	338 566
Stage 1	-	-	-	-	606 -
Stage 2	-	-	-	-	729 -
Platoon blocked, %	-	-	-	-	-
Mov Cap-1 Maneuver	-	-	1054	-	337 566
Mov Cap-2 Maneuver	-	-	-	-	453 -
Stage 1	-	-	-	-	606 -
Stage 2	-	-	-	-	727 -

Approach	EB	WB	NB
HCM Control Delay, s	0	0.1	13.8
HCM LOS			B

Minor Lane/Major Mvmt	NBLn1	EBT	EBR	WBL	WBT
Capacity (veh/h)	479	-	-	1054	-
HCM Lane V/C Ratio	0.148	-	-	0.003	-
HCM Control Delay (s)	13.8	-	-	8.4	-
HCM Lane LOS	B	-	-	A	-
HCM 95th %tile Q(veh)	0.5	-	-	0	-

HCM 6th TWSC
40: Office East Driveway & E. Rosemary Street

09/01/2020

Intersection						
Int Delay, s/veh	1					
Movement	EBT	EBR	WBL	WBT	NBL	NBR
Lane Configurations						
Traffic Vol, veh/h	471	6	5	273	26	21
Future Vol, veh/h	471	6	5	273	26	21
Conflicting Peds, #/hr	0	0	0	0	0	0
Sign Control	Free	Free	Free	Free	Stop	Stop
RT Channelized	-	None	-	None	-	None
Storage Length	-	-	65	-	0	-
Veh in Median Storage, #	0	-	-	0	0	-
Grade, %	0	-	-	2	0	-
Peak Hour Factor	92	92	92	92	75	75
Heavy Vehicles, %	2	2	2	2	2	2
Mvmt Flow	512	7	5	297	35	28

Major/Minor	Major1	Major2	Minor1		
Conflicting Flow All	0	0	519	0	823 516
Stage 1	-	-	-	-	516 -
Stage 2	-	-	-	-	307 -
Critical Hdwy	-	-	4.12	-	6.42 6.22
Critical Hdwy Stg 1	-	-	-	-	5.42 -
Critical Hdwy Stg 2	-	-	-	-	5.42 -
Follow-up Hdwy	-	-	2.218	-	3.518 3.318
Pot Cap-1 Maneuver	-	-	1047	-	343 559
Stage 1	-	-	-	-	599 -
Stage 2	-	-	-	-	746 -
Platoon blocked, %	-	-	-	-	-
Mov Cap-1 Maneuver	-	-	1047	-	341 559
Mov Cap-2 Maneuver	-	-	-	-	455 -
Stage 1	-	-	-	-	599 -
Stage 2	-	-	-	-	742 -

Approach	EB	WB	NB
HCM Control Delay, s	0	0.2	13.3
HCM LOS			B

Minor Lane/Major Mvmt	NBLn1	EBT	EBR	WBL	WBT
Capacity (veh/h)	496	-	-	1047	-
HCM Lane V/C Ratio	0.126	-	-	0.005	-
HCM Control Delay (s)	13.3	-	-	8.5	-
HCM Lane LOS	B	-	-	A	-
HCM 95th %tile Q(veh)	0.4	-	-	0	-



2023 With Office Building Site – 1 Site Access Driveway

HCM 6th TWSC
 5: E. Rosemary Street & E Rosemary Deck

09/01/2020

Intersection						
Int Delay, s/veh	1.9					
Movement	EBL	EBT	WBT	WBR	SBL	SBR
Lane Configurations						
Traffic Vol, veh/h	121	271	233	80	6	11
Future Vol, veh/h	121	271	233	80	6	11
Conflicting Peds, #/hr	16	0	0	16	16	16
Sign Control	Free	Free	Free	Free	Stop	Stop
RT Channelized	-	None	-	None	-	None
Storage Length	150	-	-	-	0	0
Veh in Median Storage, #	-	0	0	-	0	-
Grade, %	-	0	2	-	0	-
Peak Hour Factor	90	90	90	90	50	50
Heavy Vehicles, %	2	2	2	2	2	2
Mvmt Flow	134	301	259	89	12	22

Major/Minor	Major1	Major2	Minor2		
Conflicting Flow All	364	0	-	0	905 336
Stage 1	-	-	-	-	320 -
Stage 2	-	-	-	-	585 -
Critical Hdwy	4.12	-	-	-	6.42 6.22
Critical Hdwy Stg 1	-	-	-	-	5.42 -
Critical Hdwy Stg 2	-	-	-	-	5.42 -
Follow-up Hdwy	2.218	-	-	-	3.518 3.318
Pot Cap-1 Maneuver	1195	-	-	-	307 706
Stage 1	-	-	-	-	736 -
Stage 2	-	-	-	-	557 -
Platoon blocked, %		-	-	-	
Mov Cap-1 Maneuver	1177	-	-	-	264 685
Mov Cap-2 Maneuver	-	-	-	-	264 -
Stage 1	-	-	-	-	643 -
Stage 2	-	-	-	-	549 -

Approach	EB	WB	SB
HCM Control Delay, s	2.6	0	13.5
HCM LOS			B

Minor Lane/Major Mvmt	EBL	EBT	WBT	WBR	SBLn1	SBLn2
Capacity (veh/h)	1177	-	-	-	264	685
HCM Lane V/C Ratio	0.114	-	-	-	0.045	0.032
HCM Control Delay (s)	8.5	-	-	-	19.3	10.4
HCM Lane LOS	A	-	-	-	C	B
HCM 95th %tile Q(veh)	0.4	-	-	-	0.1	0.1

HCM 6th TWSC
 18: E Rosemary Deck & North Street

09/01/2020

Intersection						
Int Delay, s/veh	0.6					
Movement	EBT	EBR	WBL	WBT	NBL	NBR
Lane Configurations						
Traffic Vol, veh/h	18	67	0	19	6	1
Future Vol, veh/h	18	67	0	19	6	1
Conflicting Peds, #/hr	0	0	0	0	0	0
Sign Control	Free	Free	Free	Free	Stop	Stop
RT Channelized	-	None	-	None	-	None
Storage Length	-	-	-	-	0	-
Veh in Median Storage, #	0	-	-	0	0	-
Grade, %	0	-	-	2	0	-
Peak Hour Factor	92	92	92	92	92	92
Heavy Vehicles, %	2	2	2	2	2	2
Mvmt Flow	20	73	0	21	7	1

Major/Minor	Major1	Major2	Minor1	Minor2	Minor3
Conflicting Flow All	0	0	93	0	78
Stage 1	-	-	-	-	57
Stage 2	-	-	-	-	21
Critical Hdwy	-	-	4.12	-	6.42
Critical Hdwy Stg 1	-	-	-	-	5.42
Critical Hdwy Stg 2	-	-	-	-	5.42
Follow-up Hdwy	-	-	2.218	-	3.518
Pot Cap-1 Maneuver	-	-	1501	-	925
Stage 1	-	-	-	-	966
Stage 2	-	-	-	-	1002
Platoon blocked, %	-	-	-	-	-
Mov Cap-1 Maneuver	-	-	1501	-	925
Mov Cap-2 Maneuver	-	-	-	-	925
Stage 1	-	-	-	-	966
Stage 2	-	-	-	-	1002

Approach	EB	WB	NB
HCM Control Delay, s	0	0	8.9
HCM LOS			A

Minor Lane/Major Mvmt	NBLn1	EBT	EBR	WBL	WBT
Capacity (veh/h)	936	-	-	1501	-
HCM Lane V/C Ratio	0.008	-	-	-	-
HCM Control Delay (s)	8.9	-	-	0	-
HCM Lane LOS	A	-	-	A	-
HCM 95th %tile Q(veh)	0	-	-	0	-

HCM 6th TWSC
40: Office Single Driveway & E. Rosemary Street

09/01/2020

Intersection						
Int Delay, s/veh	1.1					
Movement	EBT	EBR	WBL	WBT	NBL	NBR
Lane Configurations						
Traffic Vol, veh/h	205	72	48	304	9	6
Future Vol, veh/h	205	72	48	304	9	6
Conflicting Peds, #/hr	0	0	0	0	0	0
Sign Control	Free	Free	Free	Free	Stop	Stop
RT Channelized	-	None	-	None	-	None
Storage Length	-	-	65	-	0	-
Veh in Median Storage, #	0	-	-	0	0	-
Grade, %	0	-	-	2	0	-
Peak Hour Factor	92	92	92	92	50	50
Heavy Vehicles, %	2	2	2	2	2	2
Mvmt Flow	223	78	52	330	18	12

Major/Minor	Major1	Major2	Minor1		
Conflicting Flow All	0	0	301	0	696 262
Stage 1	-	-	-	-	262 -
Stage 2	-	-	-	-	434 -
Critical Hdwy	-	-	4.12	-	6.42 6.22
Critical Hdwy Stg 1	-	-	-	-	5.42 -
Critical Hdwy Stg 2	-	-	-	-	5.42 -
Follow-up Hdwy	-	-	2.218	-	3.518 3.318
Pot Cap-1 Maneuver	-	-	1260	-	408 777
Stage 1	-	-	-	-	782 -
Stage 2	-	-	-	-	653 -
Platoon blocked, %	-	-	-	-	-
Mov Cap-1 Maneuver	-	-	1260	-	391 777
Mov Cap-2 Maneuver	-	-	-	-	491 -
Stage 1	-	-	-	-	782 -
Stage 2	-	-	-	-	626 -

Approach	EB	WB	NB
HCM Control Delay, s	0	1.1	11.6
HCM LOS			B

Minor Lane/Major Mvmt	NBLn1	EBT	EBR	WBL	WBT
Capacity (veh/h)	576	-	-	1260	-
HCM Lane V/C Ratio	0.052	-	-	0.041	-
HCM Control Delay (s)	11.6	-	-	8	-
HCM Lane LOS	B	-	-	A	-
HCM 95th %tile Q(veh)	0.2	-	-	0.1	-

Intersection						
Int Delay, s/veh	3.5					
Movement	EBL	EBT	WBT	WBR	SBL	SBR
Lane Configurations						
Traffic Vol, veh/h	95	324	241	63	40	72
Future Vol, veh/h	95	324	241	63	40	72
Conflicting Peds, #/hr	16	0	0	16	0	0
Sign Control	Free	Free	Free	Free	Stop	Stop
RT Channelized	-	None	-	None	-	None
Storage Length	150	-	-	-	0	0
Veh in Median Storage, #	-	0	0	-	0	-
Grade, %	-	0	2	-	0	-
Peak Hour Factor	90	90	90	90	56	56
Heavy Vehicles, %	2	2	2	2	2	2
Mvmt Flow	106	360	268	70	71	129

Major/Minor	Major1	Major2	Minor2
Conflicting Flow All	354	0	0
Stage 1	-	-	-
Stage 2	-	-	-
Critical Hdwy	4.12	-	-
Critical Hdwy Stg 1	-	-	-
Critical Hdwy Stg 2	-	-	-
Follow-up Hdwy	2.218	-	-
Pot Cap-1 Maneuver	1205	-	-
Stage 1	-	-	-
Stage 2	-	-	-
Platoon blocked, %	-	-	-
Mov Cap-1 Maneuver	1187	-	-
Mov Cap-2 Maneuver	-	-	-
Stage 1	-	-	-
Stage 2	-	-	-

Approach	EB	WB	SB
HCM Control Delay, s	1.9	0	12.9
HCM LOS			B

Minor Lane/Major Mvmt	EBL	EBT	WBT	WBR	SBLn1	SBLn2
Capacity (veh/h)	1187	-	-	-	401	711
HCM Lane V/C Ratio	0.089	-	-	-	0.178	0.181
HCM Control Delay (s)	8.3	-	-	-	15.9	11.2
HCM Lane LOS	A	-	-	-	C	B
HCM 95th %tile Q(veh)	0.3	-	-	-	0.6	0.7

HCM 6th TWSC
 18: E Rosemary Deck & North Street

09/01/2020

Intersection						
Int Delay, s/veh	2.4					
Movement	EBT	EBR	WBL	WBT	NBL	NBR
Lane Configurations						
Traffic Vol, veh/h	20	53	0	62	40	8
Future Vol, veh/h	20	53	0	62	40	8
Conflicting Peds, #/hr	0	0	0	0	0	0
Sign Control	Free	Free	Free	Free	Stop	Stop
RT Channelized	-	None	-	None	-	None
Storage Length	-	-	-	-	0	-
Veh in Median Storage, #	0	-	-	0	0	-
Grade, %	0	-	-	2	0	-
Peak Hour Factor	92	92	92	92	92	92
Heavy Vehicles, %	2	2	2	2	2	2
Mvmt Flow	22	58	0	67	43	9

Major/Minor	Major1	Major2	Minor1		
Conflicting Flow All	0	0	80	0	118
Stage 1	-	-	-	-	51
Stage 2	-	-	-	-	67
Critical Hdwy	-	-	4.12	-	6.42
Critical Hdwy Stg 1	-	-	-	-	5.42
Critical Hdwy Stg 2	-	-	-	-	5.42
Follow-up Hdwy	-	-	2.218	-	3.518
Pot Cap-1 Maneuver	-	-	1518	-	878
Stage 1	-	-	-	-	971
Stage 2	-	-	-	-	956
Platoon blocked, %	-	-	-	-	-
Mov Cap-1 Maneuver	-	-	1518	-	878
Mov Cap-2 Maneuver	-	-	-	-	878
Stage 1	-	-	-	-	971
Stage 2	-	-	-	-	956

Approach	EB	WB	NB
HCM Control Delay, s	0	0	9.3
HCM LOS			A

Minor Lane/Major Mvmt	NBLn1	EBT	EBR	WBL	WBT
Capacity (veh/h)	898	-	-	1518	-
HCM Lane V/C Ratio	0.058	-	-	-	-
HCM Control Delay (s)	9.3	-	-	0	-
HCM Lane LOS	A	-	-	A	-
HCM 95th %tile Q(veh)	0.2	-	-	0	-

HCM 6th TWSC
 40: Office Single Driveway & E. Rosemary Street

09/01/2020

Intersection						
Int Delay, s/veh	1.2					
Movement	EBT	EBR	WBL	WBT	NBL	NBR
Lane Configurations	↶		↷	↶	↷	
Traffic Vol, veh/h	329	34	19	275	29	16
Future Vol, veh/h	329	34	19	275	29	16
Conflicting Peds, #/hr	0	0	0	0	0	0
Sign Control	Free	Free	Free	Free	Stop	Stop
RT Channelized	-	None	-	None	-	None
Storage Length	-	-	65	-	0	-
Veh in Median Storage, #	0	-	-	0	0	-
Grade, %	0	-	-	2	0	-
Peak Hour Factor	92	92	92	92	72	72
Heavy Vehicles, %	2	2	2	2	2	2
Mvmt Flow	358	37	21	299	40	22

Major/Minor	Major1	Major2	Minor1	Minor2	Minor3
Conflicting Flow All	0	0	395	0	718
Stage 1	-	-	-	-	377
Stage 2	-	-	-	-	341
Critical Hdwy	-	-	4.12	-	6.42
Critical Hdwy Stg 1	-	-	-	-	5.42
Critical Hdwy Stg 2	-	-	-	-	5.42
Follow-up Hdwy	-	-	2.218	-	3.518
Pot Cap-1 Maneuver	-	-	1164	-	396
Stage 1	-	-	-	-	694
Stage 2	-	-	-	-	720
Platoon blocked, %	-	-	-	-	-
Mov Cap-1 Maneuver	-	-	1164	-	389
Mov Cap-2 Maneuver	-	-	-	-	497
Stage 1	-	-	-	-	694
Stage 2	-	-	-	-	707

Approach	EB	WB	NB
HCM Control Delay, s	0	0.5	12.4
HCM LOS			B

Minor Lane/Major Mvmt	NBLn1	EBT	EBR	WBL	WBT
Capacity (veh/h)	547	-	-	1164	-
HCM Lane V/C Ratio	0.114	-	-	0.018	-
HCM Control Delay (s)	12.4	-	-	8.1	-
HCM Lane LOS	B	-	-	A	-
HCM 95th %tile Q(veh)	0.4	-	-	0.1	-

HCM 6th TWSC
 5: E. Rosemary Street & E Rosemary Deck

09/01/2020

Intersection						
Int Delay, s/veh	3.4					
Movement	EBL	EBT	WBT	WBR	SBL	SBR
Lane Configurations						
Traffic Vol, veh/h	48	395	306	32	73	131
Future Vol, veh/h	48	395	306	32	73	131
Conflicting Peds, #/hr	16	0	0	16	0	0
Sign Control	Free	Free	Free	Free	Stop	Stop
RT Channelized	-	None	-	None	-	None
Storage Length	150	-	-	-	0	0
Veh in Median Storage, #	-	0	0	-	0	-
Grade, %	-	0	2	-	0	-
Peak Hour Factor	92	92	92	92	83	83
Heavy Vehicles, %	2	2	2	2	2	2
Mvmt Flow	52	429	333	35	88	158

Major/Minor	Major1	Major2	Minor2		
Conflicting Flow All	384	0	-	0	900
Stage 1	-	-	-	-	367
Stage 2	-	-	-	-	533
Critical Hdwy	4.12	-	-	-	6.42
Critical Hdwy Stg 1	-	-	-	-	5.42
Critical Hdwy Stg 2	-	-	-	-	5.42
Follow-up Hdwy	2.218	-	-	-	3.518
Pot Cap-1 Maneuver	1174	-	-	-	309
Stage 1	-	-	-	-	701
Stage 2	-	-	-	-	588
Platoon blocked, %		-	-	-	
Mov Cap-1 Maneuver	1156	-	-	-	286
Mov Cap-2 Maneuver	-	-	-	-	411
Stage 1	-	-	-	-	660
Stage 2	-	-	-	-	579

Approach	EB	WB	SB
HCM Control Delay, s	0.9	0	13.5
HCM LOS			B

Minor Lane/Major Mvmt	EBL	EBT	WBT	WBR	SBLn1	SBLn2
Capacity (veh/h)	1156	-	-	-	411	668
HCM Lane V/C Ratio	0.045	-	-	-	0.214	0.236
HCM Control Delay (s)	8.3	-	-	-	16.1	12
HCM Lane LOS	A	-	-	-	C	B
HCM 95th %tile Q(veh)	0.1	-	-	-	0.8	0.9

HCM 6th TWSC
18: E Rosemary Deck & North Street

09/01/2020

Intersection						
Int Delay, s/veh	3					
Movement	EBT	EBR	WBL	WBT	NBL	NBR
Lane Configurations						
Traffic Vol, veh/h	55	27	0	121	73	15
Future Vol, veh/h	55	27	0	121	73	15
Conflicting Peds, #/hr	0	0	0	0	0	0
Sign Control	Free	Free	Free	Free	Stop	Stop
RT Channelized	-	None	-	None	-	None
Storage Length	-	-	-	-	0	-
Veh in Median Storage, #	0	-	-	0	0	-
Grade, %	0	-	-	2	0	-
Peak Hour Factor	92	92	92	92	92	92
Heavy Vehicles, %	2	2	2	2	2	2
Mvmt Flow	60	29	0	132	79	16

Major/Minor	Major1	Major2	Minor1		
Conflicting Flow All	0	0	89	0	207 75
Stage 1	-	-	-	-	75 -
Stage 2	-	-	-	-	132 -
Critical Hdwy	-	-	4.12	-	6.42 6.22
Critical Hdwy Stg 1	-	-	-	-	5.42 -
Critical Hdwy Stg 2	-	-	-	-	5.42 -
Follow-up Hdwy	-	-	2.218	-	3.518 3.318
Pot Cap-1 Maneuver	-	-	1506	-	781 986
Stage 1	-	-	-	-	948 -
Stage 2	-	-	-	-	894 -
Platoon blocked, %	-	-	-	-	-
Mov Cap-1 Maneuver	-	-	1506	-	781 986
Mov Cap-2 Maneuver	-	-	-	-	781 -
Stage 1	-	-	-	-	948 -
Stage 2	-	-	-	-	894 -

Approach	EB	WB	NB
HCM Control Delay, s	0	0	10
HCM LOS			B

Minor Lane/Major Mvmt	NBLn1	EBT	EBR	WBL	WBT
Capacity (veh/h)	810	-	-	1506	-
HCM Lane V/C Ratio	0.118	-	-	-	-
HCM Control Delay (s)	10	-	-	0	-
HCM Lane LOS	B	-	-	A	-
HCM 95th %tile Q(veh)	0.4	-	-	0	-

HCM 6th TWSC
 40: Office East Driveway & E. Rosemary Street

09/01/2020

Intersection						
Int Delay, s/veh	2.3					
Movement	EBT	EBR	WBL	WBT	NBL	NBR
Lane Configurations						
Traffic Vol, veh/h	455	15	8	270	68	37
Future Vol, veh/h	455	15	8	270	68	37
Conflicting Peds, #/hr	0	0	0	0	0	0
Sign Control	Free	Free	Free	Free	Stop	Stop
RT Channelized	-	None	-	None	-	None
Storage Length	-	-	65	-	0	-
Veh in Median Storage, #	0	-	-	0	0	-
Grade, %	0	-	-	2	0	-
Peak Hour Factor	92	92	92	92	75	75
Heavy Vehicles, %	2	2	2	2	2	2
Mvmt Flow	495	16	9	293	91	49

Major/Minor	Major1	Major2	Minor1		
Conflicting Flow All	0	0	511	0	814 503
Stage 1	-	-	-	-	503 -
Stage 2	-	-	-	-	311 -
Critical Hdwy	-	-	4.12	-	6.42 6.22
Critical Hdwy Stg 1	-	-	-	-	5.42 -
Critical Hdwy Stg 2	-	-	-	-	5.42 -
Follow-up Hdwy	-	-	2.218	-	3.518 3.318
Pot Cap-1 Maneuver	-	-	1054	-	347 569
Stage 1	-	-	-	-	607 -
Stage 2	-	-	-	-	743 -
Platoon blocked, %	-	-	-	-	-
Mov Cap-1 Maneuver	-	-	1054	-	344 569
Mov Cap-2 Maneuver	-	-	-	-	458 -
Stage 1	-	-	-	-	607 -
Stage 2	-	-	-	-	736 -

Approach	EB	WB	NB
HCM Control Delay, s	0	0.2	15.2
HCM LOS			C

Minor Lane/Major Mvmt	NBLn1	EBT	EBR	WBL	WBT
Capacity (veh/h)	492	-	-	1054	-
HCM Lane V/C Ratio	0.285	-	-	0.008	-
HCM Control Delay (s)	15.2	-	-	8.4	-
HCM Lane LOS	C	-	-	A	-
HCM 95th %tile Q(veh)	1.2	-	-	0	-



Appendix F – SimTraffic Queuing and Blocking Reports

Summary of All Intervals

Run Number	1	2	3	4	5	Avg
Start Time	4:55	4:55	4:55	4:55	4:55	4:55
End Time	6:00	6:00	6:00	6:00	6:00	6:00
Total Time (min)	65	65	65	65	65	65
Time Recorded (min)	60	60	60	60	60	60
# of Intervals	2	2	2	2	2	2
# of Recorded Intervals	1	1	1	1	1	1
Vehs Entered	8129	8097	8167	8247	8128	8152
Vehs Exited	7781	7893	7873	7929	7806	7854
Starting Vehs	346	359	311	306	314	323
Ending Vehs	694	563	605	624	636	623
Travel Distance (mi)	4880	4924	4931	4974	4905	4923
Travel Time (hr)	571.9	587.0	499.1	571.7	614.1	568.8
Total Delay (hr)	363.9	376.4	287.0	359.2	404.2	358.2
Total Stops	17436	17525	17566	17807	18127	17693
Fuel Used (gal)	256.7	261.2	241.6	259.5	267.6	257.3

Interval #0 Information Seeding

Start Time	4:55
End Time	5:00
Total Time (min)	5
Volumes adjusted by Growth Factors.	
No data recorded this interval.	

Interval #1 Information Recording

Start Time	5:00
End Time	6:00
Total Time (min)	60
Volumes adjusted by PHF, Growth Factors.	

Run Number	1	2	3	4	5	Avg
Vehs Entered	8129	8097	8167	8247	8128	8152
Vehs Exited	7781	7893	7873	7929	7806	7854
Starting Vehs	346	359	311	306	314	323
Ending Vehs	694	563	605	624	636	623
Travel Distance (mi)	4880	4924	4931	4974	4905	4923
Travel Time (hr)	571.9	587.0	499.1	571.7	614.1	568.8
Total Delay (hr)	363.9	376.4	287.0	359.2	404.2	358.2
Total Stops	17436	17525	17566	17807	18127	17693
Fuel Used (gal)	256.7	261.2	241.6	259.5	267.6	257.3

Intersection: 1: Church Street & W. Rosemary Street

Movement	EB	WB	NB	SB
Directions Served	LTR	LTR	LTR	LTR
Maximum Queue (ft)	399	630	206	174
Average Queue (ft)	170	213	106	66
95th Queue (ft)	337	455	172	125
Link Distance (ft)	936	676	311	396
Upstream Blk Time (%)		0		
Queuing Penalty (veh)		2		
Storage Bay Dist (ft)				
Storage Blk Time (%)				
Queuing Penalty (veh)				

Intersection: 2: NC 86 (N. Columbia St) & W. Rosemary Street/E. Rosemary Street

Movement	EB	EB	WB	WB	NB	NB	NB	SB	SB	SB	SB
Directions Served	L	TR	L	TR	L	T	TR	L	T	T	R
Maximum Queue (ft)	124	690	225	397	97	166	182	174	278	272	216
Average Queue (ft)	119	432	158	304	42	81	101	66	135	153	89
95th Queue (ft)	144	723	279	462	85	132	152	139	232	240	172
Link Distance (ft)		676		379		275	275		405	405	
Upstream Blk Time (%)		2		19							
Queuing Penalty (veh)		14		96							
Storage Bay Dist (ft)	100		200		75			150			400
Storage Blk Time (%)	41	25	10	35	4	26		0	5		
Queuing Penalty (veh)	151	67	32	44	15	16		1	4		

Intersection: 5: E. Rosemary Street & E Rosemary Deck

Movement	EB	EB	WB	B39	SB	SB
Directions Served	L	T	TR	T	L	R
Maximum Queue (ft)	70	68	102	172	178	197
Average Queue (ft)	16	9	36	41	65	95
95th Queue (ft)	52	83	107	151	160	202
Link Distance (ft)		379	21	116	177	177
Upstream Blk Time (%)			19	7	6	23
Queuing Penalty (veh)			73	26	0	0
Storage Bay Dist (ft)	100					
Storage Blk Time (%)		2				
Queuing Penalty (veh)		1				

Intersection: 6: Henderson Street & E. Rosemary Street

Movement	EB	EB	WB	NB	SB
Directions Served	L	TR	LTR	LTR	LTR
Maximum Queue (ft)	109	202	469	154	200
Average Queue (ft)	29	131	123	66	67
95th Queue (ft)	88	215	366	124	148
Link Distance (ft)		185	1133	287	416
Upstream Blk Time (%)		7	0		0
Queuing Penalty (veh)		39	1		0
Storage Bay Dist (ft)	85				
Storage Blk Time (%)	0	21			
Queuing Penalty (veh)	1	10			

Intersection: 7: Hillsborough Street & E. Rosemary Street

Movement	EB	WB	NB	NB	SB	SB
Directions Served	LTR	LTR	L	TR	L	TR
Maximum Queue (ft)	309	197	124	217	88	187
Average Queue (ft)	141	104	66	90	24	87
95th Queue (ft)	263	174	121	169	64	152
Link Distance (ft)	1133	493		293		697
Upstream Blk Time (%)				0		
Queuing Penalty (veh)				0		
Storage Bay Dist (ft)			100		100	
Storage Blk Time (%)			2	4		6
Queuing Penalty (veh)			6	8		2

Intersection: 8: Carolina Square Driveway/Church Street & W. Franklin Street

Movement	EB	EB	WB	WB	B36	NB	NB	SB
Directions Served	L	TR	L	TR	T	LT	R	LTR
Maximum Queue (ft)	174	336	225	314	110	127	99	199
Average Queue (ft)	70	184	43	248	17	52	33	112
95th Queue (ft)	155	298	148	334	68	104	74	181
Link Distance (ft)		964		226	388	253		311
Upstream Blk Time (%)			0	13				
Queuing Penalty (veh)			0	108				
Storage Bay Dist (ft)	150		200				100	
Storage Blk Time (%)	0	12		17		2	0	
Queuing Penalty (veh)	1	9		7		1	0	

Queuing and Blocking Report
 2023 Build w 1 Office Access PM Peak

09/03/2020

Intersection: 9: NC 86 (S. Columbia St)/NC 86 (N. Columbia St) & W. Franklin Street/E. Franklin Street

Movement	EB	EB	EB	B36	WB	WB	WB	NB	NB	NB	SB	SB
Directions Served	L	T	TR	T	L	T	R	L	T	TR	L	T
Maximum Queue (ft)	274	401	332	114	149	911	905	149	359	377	142	287
Average Queue (ft)	224	235	190	8	113	800	586	66	124	166	74	140
95th Queue (ft)	319	405	298	71	182	1096	1199	127	264	293	142	274
Link Distance (ft)		388	388	226		877	877		885	885		275
Upstream Blk Time (%)		3	0	0		25	9					1
Queuing Penalty (veh)		11	0	2		96	33					5
Storage Bay Dist (ft)	250				125			475			125	
Storage Blk Time (%)	27	0			12	56			0		4	10
Queuing Penalty (veh)	68	1			72	68			0		10	8

Intersection: 9: NC 86 (S. Columbia St)/NC 86 (N. Columbia St) & W. Franklin Street/E. Franklin Street

Movement	SB
Directions Served	TR
Maximum Queue (ft)	283
Average Queue (ft)	179
95th Queue (ft)	292
Link Distance (ft)	275
Upstream Blk Time (%)	2
Queuing Penalty (veh)	8
Storage Bay Dist (ft)	
Storage Blk Time (%)	
Queuing Penalty (veh)	

Intersection: 10: E. Franklin Street & Henderson Street

Movement	EB	EB	WB	WB	SB
Directions Served	LT	T	T	TR	LR
Maximum Queue (ft)	250	251	911	896	291
Average Queue (ft)	142	155	441	412	181
95th Queue (ft)	231	242	950	943	301
Link Distance (ft)	877	877	1130	1130	287
Upstream Blk Time (%)			2	1	7
Queuing Penalty (veh)			6	5	17
Storage Bay Dist (ft)					
Storage Blk Time (%)					
Queuing Penalty (veh)					

Intersection: 11: Raleigh Street/Hillsborough Street & E. Franklin Street

Movement	EB	EB	EB	WB	WB	WB	NB	SB	SB
Directions Served	L	T	TR	L	T	TR	LTR	L	TR
Maximum Queue (ft)	100	339	358	100	376	380	420	125	285
Average Queue (ft)	49	121	158	51	204	206	221	64	164
95th Queue (ft)	101	265	301	105	329	334	353	132	268
Link Distance (ft)		1130	1130		978	978	917		293
Upstream Blk Time (%)									0
Queuing Penalty (veh)									0
Storage Bay Dist (ft)	75			75				100	
Storage Blk Time (%)	12	11		8	28			2	29
Queuing Penalty (veh)	38	6		31	19			5	22

Intersection: 13: NC 86 (N. Columbia St)/NC 86 (MLK Jr. Blvd) & North Street & N. Columbia Street

Movement	WB	WB	NB	NB	NB	SB	SB	SB	SE
Directions Served	ULR	>	L	T	TR	L	T	TR	<LR
Maximum Queue (ft)	141	75	113	138	155	94	183	248	157
Average Queue (ft)	47	56	32	43	49	30	65	101	65
95th Queue (ft)	109	83	81	104	119	73	158	216	123
Link Distance (ft)	137			405	405		1983	1983	618
Upstream Blk Time (%)	1								
Queuing Penalty (veh)	2								
Storage Bay Dist (ft)		50	150			70			
Storage Blk Time (%)	8	15	1	0		2	6		
Queuing Penalty (veh)	13	8	3	0		7	3		

Intersection: 14: NC 86 (MLK Jr. Blvd) & Longview Street/Mill Creek Apts Driveway

Movement	EB	WB	NB	NB	NB	SB	SB	SB
Directions Served	LTR	LTR	L	T	TR	L	T	TR
Maximum Queue (ft)	156	83	49	244	293	39	141	146
Average Queue (ft)	61	27	10	101	117	7	68	61
95th Queue (ft)	112	60	36	186	210	27	119	120
Link Distance (ft)	403	282		1983	1983		742	742
Upstream Blk Time (%)								
Queuing Penalty (veh)								
Storage Bay Dist (ft)			225			250		
Storage Blk Time (%)				0				
Queuing Penalty (veh)				0				

Intersection: 15: NC 86 (Pittsboro St) & W. Cameron Avenue

Movement	EB	WB	WB	WB	B30	B30
Directions Served	TR	L	L	T	T	T
Maximum Queue (ft)	377	166	147	146	114	165
Average Queue (ft)	280	96	80	86	15	34
95th Queue (ft)	404	170	155	162	68	118
Link Distance (ft)	347	76	76	76	196	196
Upstream Blk Time (%)	7	21	14	6		0
Queuing Penalty (veh)	0	76	50	23		2
Storage Bay Dist (ft)						
Storage Blk Time (%)						
Queuing Penalty (veh)						

Intersection: 16: NC 86 (S. Columbia St) & W. Cameron Avenue/E. Cameron Avenue

Movement	EB	EB	WB	NB	NB	NB	SB	SB	SB
Directions Served	L	T	TR	L	LT	TR	L	R	R
Maximum Queue (ft)	105	192	973	830	844	840	335	591	621
Average Queue (ft)	22	59	683	518	676	660	185	374	433
95th Queue (ft)	70	142	1116	1057	980	972	377	576	615
Link Distance (ft)		196	946	791	791	791		885	885
Upstream Blk Time (%)		0	21	24	46	31			
Queuing Penalty (veh)		0	0	0	0	0			
Storage Bay Dist (ft)	100						310		
Storage Blk Time (%)	1	3					0	21	
Queuing Penalty (veh)	2	1					0	29	

Intersection: 17: Raleigh Street & E. Cameron Avenue/Country Club Road

Movement	EB	WB	WB	NB	NB	SB	SB
Directions Served	LTR	L	TR	L	TR	L	TR
Maximum Queue (ft)	390	154	269	134	230	100	780
Average Queue (ft)	179	32	152	48	105	96	396
95th Queue (ft)	335	96	238	114	186	114	768
Link Distance (ft)	563		616		374		917
Upstream Blk Time (%)	0						
Queuing Penalty (veh)	0						
Storage Bay Dist (ft)		150		125		75	
Storage Blk Time (%)			9	0	5	40	30
Queuing Penalty (veh)			3	0	3	116	97

Intersection: 18: E Rosemary Deck & North Street

Movement	WB	NB
Directions Served	LT	LR
Maximum Queue (ft)	14	64
Average Queue (ft)	0	35
95th Queue (ft)	10	57
Link Distance (ft)	400	164
Upstream Blk Time (%)		
Queuing Penalty (veh)		
Storage Bay Dist (ft)		
Storage Blk Time (%)		
Queuing Penalty (veh)		

Intersection: 40: Office East Driveway & E. Rosemary Street

Movement	EB	B39	WB	WB	NB
Directions Served	TR	T	L	T	LR
Maximum Queue (ft)	185	54	31	122	129
Average Queue (ft)	32	7	3	16	69
95th Queue (ft)	131	47	18	92	126
Link Distance (ft)	116	21		185	121
Upstream Blk Time (%)	6	4		2	12
Queuing Penalty (veh)	29	18		6	0
Storage Bay Dist (ft)			65		
Storage Blk Time (%)				4	
Queuing Penalty (veh)				0	

Network Summary

Network wide Queuing Penalty: 1760



Appendix G – Signal Warrant Analysis

Warrants Summary												
Information												
Analyst	CRS						Intersection	NC 86 & North/N. Columbia				
Agency/Co	HNTB North Carolina, PC						Jurisdiction	Chapel Hill, NC				
Date Performed	9/2/2020						Units	U.S. Customary				
Project ID	Rosemary Parking Deck/Office						Time Period Analyzed	2023 - Alt 2 + Office Building				
East/West Street	North St/N. Columbia St						North/South Street	NC 86 (MLK Jr. Blvd)				
File Name	2023 Build Alt2 Deck+Office.xhy						Major Street	North-South				
Project Description <i>Rosemary Parking Deck/Office</i>												
General						Roadway Network						
Major Street Speed (mph)	35	<input type="checkbox"/>	Population < 10,000				Two Major Routes			<input type="checkbox"/>		
Nearest Signal (ft)	0	<input type="checkbox"/>	Coordinated Signal System				Weekend Count			<input type="checkbox"/>		
Crashes (per year)	0	<input type="checkbox"/>	Adequate Trials of Alternatives				5-yr Growth Factor			0		
Geometry and Traffic	EB			WB			NB			SB		
	LT	TH	RT	LT	TH	RT	LT	TH	RT	LT	TH	RT
Number of lanes, N	0	1	0	0	1	0	1	2	0	1	2	0
Lane usage	LTR			LTR			L	TR	L			TR
Vehicle Volume Averages (vph)	0	1	9	2	2	10	10	144	2	16	169	1
Peds (ped/h) / Gaps (gaps/h)	--	0 / 0	--	--	0 / 0	--	--	0 / 0	--	--	0 / 0	--
Delay (s/veh) / (veh-hr)	--	6.0 / 0.1	--	--	20.8 / 0.6	--	--	0.2 / 0.0	--	--	0.2 / 0.1	--
Warrant 1: Eight-Hour Vehicular Volume												<input type="checkbox"/>
1 A. Minimum Vehicular Volumes (Both major approaches --and-- higher minor approach) --or--												<input type="checkbox"/>
1 B. Interruption of Continuous Traffic (Both major approaches --and-- higher minor approach) --or--												<input type="checkbox"/>
1 (80%) Vehicular --and-- Interruption Volumes (Both major approaches --and-- higher minor approach)												<input type="checkbox"/>
Warrant 2: Four-Hour Vehicular Volume												<input type="checkbox"/>
2 A. Four-Hour Vehicular Volumes (Both major approaches --and-- higher minor approach)												<input type="checkbox"/>
Warrant 3: Peak Hour												<input checked="" type="checkbox"/>
3 A. Peak-Hour Conditions (Minor delay --and-- minor volume --and-- total volume) --or--												<input checked="" type="checkbox"/>
3 B. Peak- Hour Vehicular Volumes (Both major approaches --and-- higher minor approach)												<input checked="" type="checkbox"/>
Warrant 4: Pedestrian Volume												<input type="checkbox"/>
4 A. Four Hour Volumes --or--												<input type="checkbox"/>
4 B. One-Hour Volumes												<input type="checkbox"/>
Warrant 5: School Crossing												<input type="checkbox"/>
5. Student Volumes --and--												<input type="checkbox"/>
5. Gaps Same Period												<input type="checkbox"/>
Warrant 6: Coordinated Signal System												<input type="checkbox"/>
6. Degree of Platooning (Predominant direction or both directions)												<input type="checkbox"/>
Warrant 7: Crash Experience												<input type="checkbox"/>
7 A. Adequate trials of alternatives, observance and enforcement failed --and--												<input type="checkbox"/>
7 B. Reported crashes susceptible to correction by signal (12-month period) --and--												<input type="checkbox"/>

7 C. (80%) Volumes for Warrants 1A, 1B --or-- 4 are satisfied	<input type="checkbox"/>
Warrant 8: Roadway Network	<input type="checkbox"/>
8 A. Weekday Volume (Peak hour total --and-- projected warrants 1, 2 or 3) --or--	<input type="checkbox"/>
8 B. Weekend Volume (Five hours total)	<input type="checkbox"/>
Warrant 9: Grade Crossing	<input type="checkbox"/>
9 A. Grade Crossing within 140 ft --and--	<input type="checkbox"/>
9 B. Peak-Hour Vehicular Volumes	<input type="checkbox"/>

Warrants Volume

Information			
Analyst	CRS	Intersection	NC 86 & North/N. Columbia
Agency/Co	HNTB North Carolina, PC	Jurisdiction	Chapel Hill, NC
Date Performed	9/2/2020	Units	U.S. Customary
Project ID	Rosemary Parking Deck/Office	Time Period Analyzed	2023 - Alt 2 + Office Building
East/West Street	North St/N. Columbia St	North/South Street	NC 86 (MLK Jr. Blvd)
File Name	2023 Build Alt2 Deck+Office.xhy	Major Street	North-South

Project Description *Rosemary Parking Deck/Office*

Warrant 1

Condition A—Minimum Vehicular Volume										Condition B—Interruption of Continuous Traffic									
Number of lanes for moving traffic on each approach		Vehicles per hour on major street (total of both approaches)				Vehicles per hour on higher-volume minor-street approach (one direction only)				Number of lanes for moving traffic on each approach		Vehicles per hour on major street (total of both approaches)				Vehicles per hour on higher-volume minor-street approach (one direction only)			
Major Street	Minor Street	100%	80%	70%	56%	100%	80%	70%	56%	Major Street	Minor Street	100%	80%	70%	56%	100%	80%	70%	56%
1	1	500	400	350	280	150	120	105	84	1	1	750	600	525	420	75	60	53	42
2 or more	1	600	480	420	336	150	120	105	84	2 or more	1	900	720	630	504	75	60	53	42
2 or more	2 or more	600	480	420	336	200	160	140	112	2 or more	2 or more	900	720	630	504	100	80	70	56
1	2 or more	500	400	350	280	200	160	140	112	1	2 or more	750	600	525	420	100	80	70	56

Warrant 2

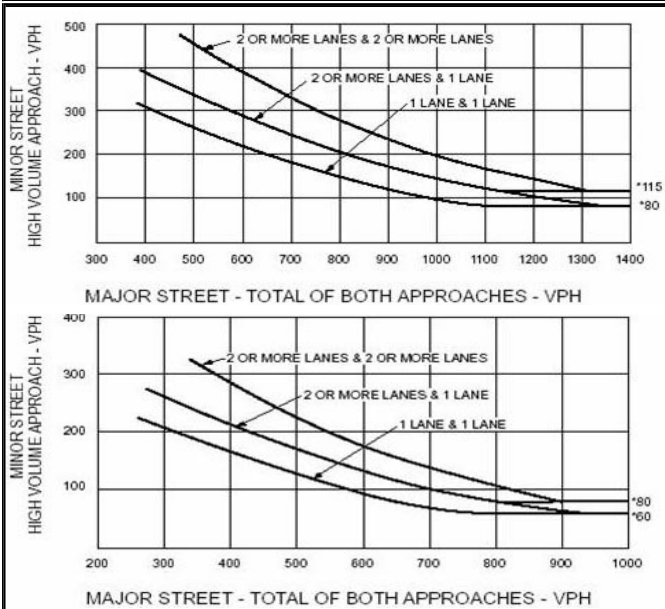

Warrant 3

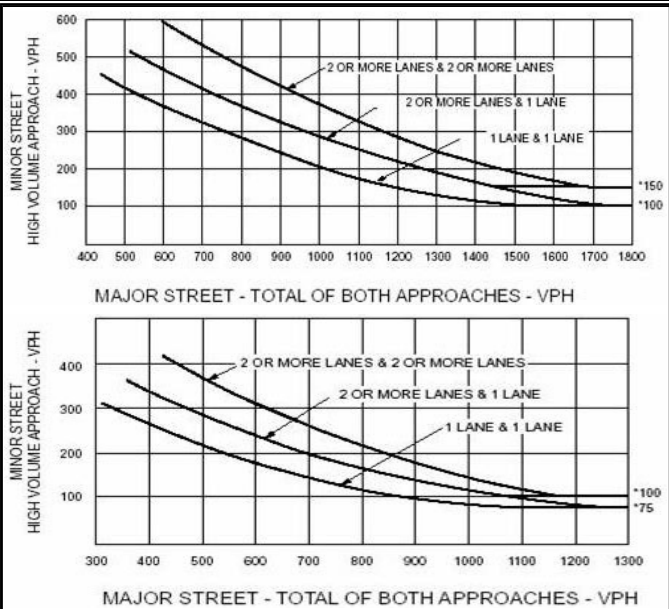

Volume Summary

Major Street Lanes 2+			Minor Street Lanes 1		Speed		35		Population		10000+	
Hours	Major Volume	Minor Volume	Total Volume	1A (100%)	1A (80%)	1B (100%)	1B (80%)	2 (100%)	3A (100%)	3B (100%)		
07-08	1326	36	1377	No	No	No	No	No	No	No	No	No
08-09	0	0	0	No	No	No	No	No	No	No	No	No
09-10	0	0	0	No	No	No	No	No	No	No	No	No
10-11	0	0	0	No	No	No	No	No	No	No	No	No
11-12	0	0	0	No	No	No	No	No	No	No	No	No
12-13	1120	60	1218	No	No	No	Yes	No	No	No	No	No
13-14	0	0	0	No	No	No	No	No	No	No	No	No
14-15	0	0	0	No	No	No	No	No	No	No	No	No
15-16	0	0	0	No	No	No	No	No	No	No	No	No
16-17	1695	119	1874	No	No	Yes	Yes	Yes	Yes	Yes	Yes	Yes
17-18	0	0	0	No	No	No	No	No	No	No	No	No
18-19	0	0	0	No	No	No	No	No	No	No	No	No
Totals	4141	215	4469	0	0	1	2	1	1	1	1	1



Appendix H – Crash Data

**North Carolina Department of Transportation
Traffic Engineering Accident Analysis System
Strip Analysis Report**

Acc No	Crash ID	Milepost	Date	Accident Type	Total Damage	Injuries				Condition			Road		Trfc Ctl	
						F	A	B	C	R	L	W	Ch	Ci	Dv	Op
8	105373901	0.667	01/16/2018 17:10	REAR END, SLOW OR STOP	\$ 2000	0	0	0	0	1	2	1	0			
Unit	1 : 1	Alchl/Drugs:	0	Speed:	0 MPH Dir: W	Veh Mnvr/Ped Actn:				1	Obj Strk:					
Unit	2 : 1	Alchl/Drugs:	0	Speed:	0 MPH Dir: W	Veh Mnvr/Ped Actn:				4	Obj Strk:					
9	105434861	0.667	03/20/2018 15:06	SIDESWIPE, SAME DIRECTION	\$ 2900	0	0	0	0	1	1	2	0			
Unit	1 : 7	Alchl/Drugs:	0	Speed:	0 MPH Dir: E	Veh Mnvr/Ped Actn:				4	Obj Strk:					
Unit	2 : 1	Alchl/Drugs:	0	Speed:	0 MPH Dir: E	Veh Mnvr/Ped Actn:				5	Obj Strk:					
10	105491232	0.667	05/20/2018 21:53	LEFT TURN, SAME ROADWAY	\$ 6000	0	0	0	0	1	3	1	1	0	3	1
Unit	1 : 1	Alchl/Drugs:	0	Speed:	15 MPH Dir: E	Veh Mnvr/Ped Actn:				8	Obj Strk:					
Unit	2 : 1	Alchl/Drugs:	0	Speed:	20 MPH Dir: W	Veh Mnvr/Ped Actn:				4	Obj Strk:					
11	105544869	0.667	07/12/2018 10:28	REAR END, SLOW OR STOP	\$ 1000	0	0	0	0	1	1	1	1	0	3	2
Unit	1 : 1	Alchl/Drugs:	0	Speed:	5 MPH Dir: W	Veh Mnvr/Ped Actn:				11	Obj Strk:					
Unit	2 : 1	Alchl/Drugs:	0	Speed:	0 MPH Dir: W	Veh Mnvr/Ped Actn:				11	Obj Strk:					
12	105653065	0.667	10/12/2018 15:44	LEFT TURN, DIFFERENT ROADWAYS	\$ 2000	0	0	0	0	1	1	1	1	0	3	1
Unit	1 : 1	Alchl/Drugs:	0	Speed:	10 MPH Dir: W	Veh Mnvr/Ped Actn:				8	Obj Strk:					
Unit	2 : 1	Alchl/Drugs:	0	Speed:	20 MPH Dir: E	Veh Mnvr/Ped Actn:				4	Obj Strk:					
13	105746585	0.667	12/31/2018 21:25	ANGLE	\$ 1600	0	0	0	0	2	4	2	3	0	3	1
Unit	1 : 1	Alchl/Drugs:	0	Speed:	15 MPH Dir: S	Veh Mnvr/Ped Actn:				4	Obj Strk:					
Unit	2 : 1	Alchl/Drugs:	0	Speed:	10 MPH Dir: E	Veh Mnvr/Ped Actn:				4	Obj Strk:					
14	105792934	0.667	02/23/2019 07:51	ANGLE	\$ 2150	0	0	0	0	2	1	3	1	0	3	1
Unit	1 : 1	Alchl/Drugs:	0	Speed:	25 MPH Dir: W	Veh Mnvr/Ped Actn:				4	Obj Strk:					
Unit	2 : 1	Alchl/Drugs:	0	Speed:	15 MPH Dir: N	Veh Mnvr/Ped Actn:				4	Obj Strk:					
15	105800967	0.667	03/10/2019 00:02	PEDESTRIAN	\$ 0	0	0	1	0	1	4	2	1	12	3	1
Unit	1 : 32	Alchl/Drugs:	7	Speed:	5 MPH Dir: N	Veh Mnvr/Ped Actn:				8	Obj Strk:					
Unit	2 : 24	Alchl/Drugs:	2	Speed:	0 MPH Dir:	Veh Mnvr/Ped Actn:					Obj Strk:					
16	105824361	0.671	03/25/2019 16:44	REAR END, SLOW OR STOP	\$ 1100	0	0	0	0	2	1	3	1	0	3	2
Unit	1 : 1	Alchl/Drugs:	0	Speed:	0 MPH Dir: E	Veh Mnvr/Ped Actn:				1	Obj Strk:					
Unit	2 : 1	Alchl/Drugs:	0	Speed:	5 MPH Dir: E	Veh Mnvr/Ped Actn:				4	Obj Strk:					

**North Carolina Department of Transportation
Traffic Engineering Accident Analysis System
Strip Analysis Report**

Acc No	Crash ID	Milepost	Date	Accident Type	Total Damage	Injuries				Condition			Road		Trfc Ctl	
						F	A	B	C	R	L	W	Ch	Ci	Dv	Op
17	105748774	0.673	12/29/2018 23:49	HEAD ON	\$ 9000	0	0	0	0	1	4	1	2	0	3	1
Unit	1 : 4	Alchl/Drgs:	1	Speed:	30 MPH	Dir:	E	Veh Mnvr/Ped Actn:				6	Obj Strk:			
Unit	2 : 2	Alchl/Drgs:	0	Speed:	0 MPH	Dir:	W	Veh Mnvr/Ped Actn:				1	Obj Strk:			
Unit	3 : 1	Alchl/Drgs:	0	Speed:	20 MPH	Dir:	E	Veh Mnvr/Ped Actn:				4	Obj Strk:			
18	105319155	0.676	12/01/2017 10:47	REAR END, SLOW OR STOP	\$ 2500	0	0	0	0	1	1	1	3	0	3	1
Unit	1 : 1	Alchl/Drgs:	0	Speed:	20 MPH	Dir:	W	Veh Mnvr/Ped Actn:				1	Obj Strk:			
Unit	2 : 4	Alchl/Drgs:	0	Speed:	20 MPH	Dir:	W	Veh Mnvr/Ped Actn:				4	Obj Strk:			
19	104540531	0.682	10/26/2015 14:10	REAR END, SLOW OR STOP	\$ 2750	0	0	0	0	1	1	2	1	0	0	
Unit	1 : 1	Alchl/Drgs:	0	Speed:	15 MPH	Dir:	W	Veh Mnvr/Ped Actn:				4	Obj Strk:			
Unit	2 : 4	Alchl/Drgs:	0	Speed:	0 MPH	Dir:	W	Veh Mnvr/Ped Actn:				5	Obj Strk:			
20	105217658	0.682	09/05/2017 19:19	LEFT TURN, SAME ROADWAY	\$ 1500	0	0	0	0	1	1	1	1	0	3	1
Unit	1 : 1	Alchl/Drgs:	0	Speed:	10 MPH	Dir:	SW	Veh Mnvr/Ped Actn:				12	Obj Strk:			
Unit	2 : 1	Alchl/Drgs:	0	Speed:	25 MPH	Dir:	SW	Veh Mnvr/Ped Actn:				4	Obj Strk:			
21	105142349	0.685	06/20/2017 13:41	REAR END, SLOW OR STOP	\$ 1900	0	0	0	0	1	1	1	3	0	3	1
Unit	1 : 2	Alchl/Drgs:	0	Speed:	20 MPH	Dir:	W	Veh Mnvr/Ped Actn:				1	Obj Strk:			
Unit	2 : 1	Alchl/Drgs:	0	Speed:	20 MPH	Dir:	W	Veh Mnvr/Ped Actn:				4	Obj Strk:			
22	105103247	0.724	05/11/2017 15:47	REAR END, SLOW OR STOP	\$ 3500	0	0	0	1	1	1	1	1	0	3	2
Unit	1 : 4	Alchl/Drgs:	0	Speed:	25 MPH	Dir:	E	Veh Mnvr/Ped Actn:				4	Obj Strk:			
Unit	2 : 1	Alchl/Drgs:	0	Speed:	0 MPH	Dir:	E	Veh Mnvr/Ped Actn:				1	Obj Strk:			
Unit	3 : 1	Alchl/Drgs:	0	Speed:	0 MPH	Dir:	E	Veh Mnvr/Ped Actn:				1	Obj Strk:			
23	105296203	0.730	11/16/2017 13:02	REAR END, SLOW OR STOP	\$ 1900	0	0	0	0	1	1	1	1	0	0	
Unit	1 : 4	Alchl/Drgs:	0	Speed:	0 MPH	Dir:	E	Veh Mnvr/Ped Actn:				1	Obj Strk:			
Unit	2 : 1	Alchl/Drgs:	0	Speed:	10 MPH	Dir:	E	Veh Mnvr/Ped Actn:				4	Obj Strk:			
24	104865168	0.733	09/14/2016 18:00	LEFT TURN, DIFFERENT ROADWAYS	\$ 500	0	0	0	1	1	1	1	3	0		
Unit	1 : 1	Alchl/Drgs:	0	Speed:	15 MPH	Dir:	W	Veh Mnvr/Ped Actn:				4	Obj Strk:			
Unit	2 : 1	Alchl/Drgs:	0	Speed:	5 MPH	Dir:	S	Veh Mnvr/Ped Actn:				8	Obj Strk:			
25	105454952	0.742	04/15/2018 06:07	FIXED OBJECT	\$ 17500	0	0	0	0	1	4	1	3	0	0	
Unit	1 : 11	Alchl/Drgs:	0	Speed:	15 MPH	Dir:	W	Veh Mnvr/Ped Actn:				4	Obj Strk: 51			

**North Carolina Department of Transportation
Traffic Engineering Accident Analysis System
Strip Analysis Report**

Acc No	Crash ID	Milepost	Date	Accident Type	Total Damage	Injuries				Condition			Road		Trfc Ctl	
						F	A	B	C	R	L	W	Ch	Ci	Dv	Op
26	105061193	0.752	04/03/2017 10:21	REAR END, SLOW OR STOP	\$ 4000	0	0	0	0	1	1	2	1	0		2
Unit	1 : 1	Alchl/Drgs:	0	Speed: 20 MPH Dir: E		Veh Mnvr/Ped Actn:				4	Obj Strk:					
Unit	2 : 1	Alchl/Drgs:	0	Speed: 0 MPH Dir: E		Veh Mnvr/Ped Actn:				1	Obj Strk:					
27	105482319	0.760	04/25/2018 13:30	ANGLE	\$ 1600	0	0	0	0	1	1	2	1	0	3	1
Unit	1 : 4	Alchl/Drgs:	0	Speed: 10 MPH Dir: W		Veh Mnvr/Ped Actn:				5	Obj Strk:					
Unit	2 : 4	Alchl/Drgs:	0	Speed: 20 MPH Dir: E		Veh Mnvr/Ped Actn:				4	Obj Strk:					
28	105094221	0.800	04/06/2017 17:09	LEFT TURN, SAME ROADWAY	\$ 2000	0	0	0	0	1	1	2	1	0	1	1
Unit	1 : 1	Alchl/Drgs:	0	Speed: 8 MPH Dir: N		Veh Mnvr/Ped Actn:				8	Obj Strk:					
Unit	2 : 4	Alchl/Drgs:	0	Speed: 10 MPH Dir: E		Veh Mnvr/Ped Actn:				4	Obj Strk:					
29	104378493	0.839	05/11/2015 16:14	LEFT TURN, DIFFERENT ROADWAYS	\$ 1100	0	0	0	0	1	1	1	1	0		
Unit	1 : 1	Alchl/Drgs:	0	Speed: 10 MPH Dir: E		Veh Mnvr/Ped Actn:				4	Obj Strk:					
Unit	2 : 1	Alchl/Drgs:	0	Speed: 5 MPH Dir: W		Veh Mnvr/Ped Actn:				8	Obj Strk:					
30	106151668	0.841	01/04/2020 18:36	REAR END, SLOW OR STOP	\$ 4000	0	0	0	0	2	4	2	1	0	3	1
Unit	1 : 1	Alchl/Drgs:	0	Speed: 20 MPH Dir: NE		Veh Mnvr/Ped Actn:				4	Obj Strk:					
Unit	2 : 4	Alchl/Drgs:	0	Speed: 5 MPH Dir: NE		Veh Mnvr/Ped Actn:				11	Obj Strk:					
31	104494574	0.845	09/10/2015 16:47	ANGLE	\$ 5000	0	0	0	0	1	1	1	1	0	3	1
Unit	1 : 1	Alchl/Drgs:	0	Speed: 20 MPH Dir: N		Veh Mnvr/Ped Actn:				4	Obj Strk:					
Unit	2 : 4	Alchl/Drgs:	0	Speed: 20 MPH Dir: E		Veh Mnvr/Ped Actn:				4	Obj Strk:					
32	105142359	0.845	06/22/2017 15:56	ANGLE	\$ 13000	0	0	0	0	1	1	1	1	0	3	1
Unit	1 : 1	Alchl/Drgs:	0	Speed: 15 MPH Dir: NW		Veh Mnvr/Ped Actn:				4	Obj Strk:					
Unit	2 : 1	Alchl/Drgs:	0	Speed: 15 MPH Dir: NW		Veh Mnvr/Ped Actn:				4	Obj Strk:					
33	105472725	0.845	05/05/2018 23:56	ANGLE	\$ 1700	0	0	0	0	1	4	1	1	0	3	1
Unit	1 : 4	Alchl/Drgs:	0	Speed: 15 MPH Dir: NW		Veh Mnvr/Ped Actn:				4	Obj Strk:					
Unit	2 : 1	Alchl/Drgs:	0	Speed: 20 MPH Dir: SW		Veh Mnvr/Ped Actn:				4	Obj Strk:					
34	106040397	0.845	10/17/2019 17:00	LEFT TURN, SAME ROADWAY	\$ 10500	0	0	0	1	1	1	1	1	0	3	1
Unit	1 : 2	Alchl/Drgs:	0	Speed: 10 MPH Dir: SW		Veh Mnvr/Ped Actn:				8	Obj Strk:					
Unit	2 : 1	Alchl/Drgs:	0	Speed: 20 MPH Dir: NE		Veh Mnvr/Ped Actn:				4	Obj Strk:					

**North Carolina Department of Transportation
Traffic Engineering Accident Analysis System
Strip Analysis Report**

Acc No	Crash ID	Milepost	Date	Accident Type	Total Damage	Injuries				Condition			Road		Trfc Ctl	
						F	A	B	C	R	L	W	Ch	Ci	Dv	Op

Legend for Report Details:

- Acc No - Accident Number
- Injuries: F - Fatal, A - Class A, B - Class B, C - Class C
- Condition: R - Road Surface, L - Ambient Light, W - Weather
- Rd Ch - Road Character
- Rd Ci - Roadway Contributing Circumstances
- Trfc Ctl - Traffic Control: Dv - Device, Op - Operating
- Alchl/Drgs - Alcohol Drugs Suspected
- Veh Mnvr/Ped Actn - Vehicle Maneuver/Pedestrian Action
- Obj Strk - Object Struck

**North Carolina Department of Transportation
Traffic Engineering Accident Analysis System
Strip Analysis Report**

Summary Statistics

High Level Crash Summary

Crash Type	Number of Crashes	Percent of Total
Total Crashes	34	100.00
Fatal Crashes	0	0.00
Non-Fatal Injury Crashes	5	14.71
Total Injury Crashes	5	14.71
Property Damage Only Crashes	29	85.29
Night Crashes	9	26.47
Wet Crashes	4	11.76
Alcohol/Drugs Involvement Crashes	2	5.88

Crash Severity Summary

Crash Type	Number of Crashes	Percent of Total
Total Crashes	34	100.00
Fatal Crashes	0	0.00
Class A Crashes	1	2.94
Class B Crashes	1	2.94
Class C Crashes	3	8.82
Property Damage Only Crashes	29	85.29

Vehicle Exposure Statistics

Annual ADT = 7500

Total Length = 0.178 (Miles)

0.286 (Kilometers)

Total Vehicle Exposure = 2.44 (MVMT)

3.93 (MVKMT)

Crash Rate	Crashes Per 100 Million Vehicle Miles	Crashes Per 100 Million Vehicle Kilometers
Total Crash Rate	1393.99	866.18
Fatal Crash Rate	0.00	0.00
Non Fatal Crash Rate	205.00	127.38
Night Crash Rate	369.00	229.28
Wet Crash Rate	164.00	101.90
EPDO Rate	5715.35	3551.35

**North Carolina Department of Transportation
Traffic Engineering Accident Analysis System
Strip Analysis Report**

Miscellaneous Statistics

Severity Index = 4.10
EPDO Crash Index = 139.40
Estimated Property Damage Total = \$ 136200.00

Accident Type Summary

Accident Type	Number of Crashes	Percent of Total
ANGLE	8	23.53
FIXED OBJECT	1	2.94
HEAD ON	1	2.94
LEFT TURN, DIFFERENT ROADWAYS	3	8.82
LEFT TURN, SAME ROADWAY	5	14.71
PEDESTRIAN	1	2.94
REAR END, SLOW OR STOP	11	32.35
RIGHT TURN, DIFFERENT ROADWAYS	1	2.94
RIGHT TURN, SAME ROADWAY	2	5.88
SIDESWIPE, SAME DIRECTION	1	2.94

Injury Summary

Injury Type	Number of Injuries	Percent of Total
Fatal Injuries	0	0.00
Class A Injuries	1	20.00
Class B Injuries	1	20.00
Class C Injuries	3	60.00
Total Non-Fatal Injuries	5	100.00
Total Injuries	5	100.00

**North Carolina Department of Transportation
Traffic Engineering Accident Analysis System
Strip Analysis Report**

Monthly Summary

Month	Number of Crashes	Percent of Total
Jan	3	8.82
Feb	2	5.88
Mar	4	11.76
Apr	5	14.71
May	5	14.71
Jun	2	5.88
Jul	1	2.94
Aug	0	0.00
Sep	3	8.82
Oct	3	8.82
Nov	2	5.88
Dec	4	11.76

Daily Summary

Day	Number of Crashes	Percent of Total
Mon	6	17.65
Tue	6	17.65
Wed	2	5.88
Thu	8	23.53
Fri	3	8.82
Sat	6	17.65
Sun	3	8.82

**North Carolina Department of Transportation
Traffic Engineering Accident Analysis System
Strip Analysis Report**

Hourly Summary

Hour	Number of Crashes	Percent of Total
0000-0059	1	2.94
0100-0159	0	0.00
0200-0259	0	0.00
0300-0359	0	0.00
0400-0459	0	0.00
0500-0559	0	0.00
0600-0659	1	2.94
0700-0759	1	2.94
0800-0859	0	0.00
0900-0959	1	2.94
1000-1059	3	8.82
1100-1159	0	0.00
1200-1259	0	0.00
1300-1359	3	8.82
1400-1459	2	5.88
1500-1559	4	11.76
1600-1659	5	14.71
1700-1759	3	8.82
1800-1859	3	8.82
1900-1959	1	2.94
2000-2059	0	0.00
2100-2159	3	8.82
2200-2259	0	0.00
2300-2359	3	8.82

**North Carolina Department of Transportation
Traffic Engineering Accident Analysis System
Strip Analysis Report**

Light and Road Conditions Summary

Condition	Dry	Wet	Other	Total
Day	21	2	0	23
Dark	7	2	0	9
Other	2	0	0	2
Total	30	4	0	34

Object Struck Summary

Object Type	Times Struck	Percent of Total
OVERHEAD PART UNDERPASS	1	33.33
PEDESTRIAN	2	66.67

Vehicle Type Summary

Vehicle Type	Number Involved	Percent of Total
COMMERCIAL BUS	2	2.86
PASSENGER CAR	45	64.29
PEDESTRIAN	2	2.86
PICKUP	4	5.71
SCHOOL BUS	1	1.43
SINGLE UNIT TRUCK (3 OR MORE AXLES)	1	1.43
SPORT UTILITY	13	18.57
UNKNOWN	2	2.86

North Carolina Department of Transportation
Traffic Engineering Accident Analysis System
Strip Analysis Report

Yearly Totals Summary

Accident Totals

Year	Total Accidents	Fatal Accidents	Injury Accidents	Property Damage Only Accidents
2015	6	0	0	6
2016	3	0	1	2
2017	10	0	2	8
2018	10	0	0	10
2019	4	0	2	2
2020	1	0	0	1
Total	34	0	5	29

Injury Totals

Year	Fatal Injuries	Class A, B, or C Injuries
2015	0	0
2016	0	1
2017	0	2
2018	0	0
2019	0	2
2020	0	0
Total	0	5

Miscellaneous Totals

Year	Property Damage	EPDO Index
2015	\$ 27550	6.00
2016	\$ 14200	10.40
2017	\$ 31400	93.20
2018	\$ 45300	10.00
2019	\$ 13750	18.80
2020	\$ 4000	1.00
Total	\$ 136200	139.40

Type of Accident Totals

Year	Left Turn	Right Turn	Rear End	Run Off Road &			
				Fixed Object	Angle	Side Swipe	Other
2015	2	1	1	0	2	0	0
2016	1	1	1	0	0	0	0

**North Carolina Department of Transportation
Traffic Engineering Accident Analysis System
Strip Analysis Report**

Year	Left Turn	Right Turn	Rear End	Run Off Road & Fixed Object	Angle	Side Swipe	Other
2017	2	1	5	0	2	0	0
2018	2	0	2	1	3	1	1
2019	1	0	1	0	1	0	1
2020	0	0	1	0	0	0	0
Total	8	3	11	1	8	1	2

**North Carolina Department of Transportation
Traffic Engineering Accident Analysis System
Strip Analysis Report**

Strip Diagram

Features	Milepost	Crash IDs	
NC 86 COLUMBIA	0.67	104355645 104364752 104592789 104644618 104761803 105011016 105328702 105373901 105434861 105491232 105544869 105653065 105746585 105792934 105800967 105824361 105748774	
	0.68	105319155 104540531 105217658	
	0.69	105142349	
	0.70		
	0.71		
	0.72	105103247	
	0.73	105296203 104865168	
	0.74	105454952	
	0.75	105061193	
	0.76	105482319	
	0.77		
	0.78		
	0.79		
	0.80	105094221	
	0.81		
	0.82		
	0.83		
	0.84	104378493 106151668	
	HENDERSON	0.85	104494574 105142359 105472725 106040397

**North Carolina Department of Transportation
Traffic Engineering Accident Analysis System
Strip Analysis Report**

Study Criteria

Study Name	Log No.	PH No.	TIP No.	K/A Cf.	B/C Cf.	ADT	ADT Route
ROSEMARYDECKTIASTRIPTJF				76.8	8.4	7500	

Request Date	Courier Service	Phone No.	Ext.	Fax No.

County			Municipality			Y-Line Ft.	Begin Date	End Date	Years
Name	Code	Div.	Name	Code	Y-Line Ft.	Begin Date	End Date	Years	
ORANGE	68	7	All and Rural		0	3/1/2015	2/29/2020	5.00	

Location Text	Requestor
E. Rosemary St from NC 86 (N. Columbia St) to Henderson St	

Included Accidents	Old MP	New MP	Type
105800967		0.667	I
105454952		0.742	I
105482319		0.76	I
105094221		0.8	I

Excluded Accidents
104458325
104644616
104915606
105271558
105294540
105532154
105598098

Fiche Roads

Name	Code
ROSEMARY	50026492

Strip Road

Name	Code	Begin MP	End MP	Miles	Kilometers
ROSEMARY	50026492	0.667	0.845	0.178	0.286

**North Carolina Department of Transportation
Traffic Engineering Accident Analysis System
Strip Analysis Report**

Acc No	Crash ID	Milepost	Date	Accident Type	Total Damage	Injuries				Condition			Road		Trfc Ctl	
						F	A	B	C	R	L	W	Ch	Ci	Dv	Op
Unit	2 : 1	Alchl/Drugs:	0	Speed:	5 MPH	Dir:	S	Veh Mnvr/Ped Actn:				12	Obj Strk:			
9	105924176	1.507	06/18/2019 19:32	SIDESWIPE, SAME DIRECTION	\$ 1400	0	0	0	0	2	1	3	1	0	2	
Unit	1 : 1	Alchl/Drugs:	0	Speed:	15 MPH	Dir:	N	Veh Mnvr/Ped Actn:				4	Obj Strk:			
Unit	2 : 4	Alchl/Drugs:	0	Speed:	15 MPH	Dir:	N	Veh Mnvr/Ped Actn:				4	Obj Strk:			
10	105784524	1.508	02/14/2019 20:53	BACKING UP	\$ 2200	0	0	0	0	1	4	2	1	0	13	1
Unit	1 : 31	Alchl/Drugs:	0	Speed:	0 MPH	Dir:	N	Veh Mnvr/Ped Actn:				1	Obj Strk:			
Unit	2 : 1	Alchl/Drugs:	0	Speed:	0 MPH	Dir:	S	Veh Mnvr/Ped Actn:				1	Obj Strk:			
11	104953103	1.518	11/28/2016 13:40	REAR END, SLOW OR STOP	\$ 4000	0	0	0	0	1	1	2	1	0	3	1
Unit	1 : 32	Alchl/Drugs:	7	Speed:	0 MPH	Dir:	S	Veh Mnvr/Ped Actn:				1	Obj Strk:			
Unit	2 : 1	Alchl/Drugs:	0	Speed:	0 MPH	Dir:	S	Veh Mnvr/Ped Actn:				1	Obj Strk:			
Unit	3 : 2	Alchl/Drugs:	0	Speed:	0 MPH	Dir:	S	Veh Mnvr/Ped Actn:				4	Obj Strk:			
12	104633096	1.522	01/11/2016 12:02	RIGHT TURN, SAME ROADWAY	\$ 2850	0	0	0	0	1	1	1	1	0	3	1
Unit	1 : 6	Alchl/Drugs:	0	Speed:	5 MPH	Dir:	N	Veh Mnvr/Ped Actn:				4	Obj Strk:			
Unit	2 : 2	Alchl/Drugs:	0	Speed:	5 MPH	Dir:	N	Veh Mnvr/Ped Actn:				7	Obj Strk:			
13	105765170	1.522	01/30/2019 11:00	REAR END, TURN	\$ 4500	0	0	0	0	1	1	1	1	0		
Unit	1 : 2	Alchl/Drugs:	0	Speed:	25 MPH	Dir:	N	Veh Mnvr/Ped Actn:				4	Obj Strk:			
Unit	2 : 1	Alchl/Drugs:	0	Speed:	15 MPH	Dir:	N	Veh Mnvr/Ped Actn:				5	Obj Strk:			
14	105730355	1.526	12/16/2018 22:45	LEFT TURN, SAME ROADWAY	\$ 5500	0	0	0	0	1	4	1	1	0	0	2
Unit	1 : 1	Alchl/Drugs:	0	Speed:	15 MPH	Dir:	S	Veh Mnvr/Ped Actn:				5	Obj Strk:			
Unit	2 : 1	Alchl/Drugs:	0	Speed:	15 MPH	Dir:	S	Veh Mnvr/Ped Actn:				4	Obj Strk:			
15	106175777	1.526	02/24/2020 19:18	FIXED OBJECT	\$ 1000	0	0	0	0	2	4	3	1	0	0	1
Unit	1 : 6	Alchl/Drugs:	0	Speed:	15 MPH	Dir:	S	Veh Mnvr/Ped Actn:				5	Obj Strk: 34			
16	105366746	1.532	01/12/2018 19:05	PARKED MOTOR VEHICLE	\$ 1800	0	0	0	0	2	4	1	3	0	3	2
Unit	1 : 1	Alchl/Drugs:	7	Speed:	0 MPH	Dir:	SE	Veh Mnvr/Ped Actn:				2	Obj Strk: 20			
Unit	2 : 2	Alchl/Drugs:	0	Speed:	5 MPH	Dir:	SE	Veh Mnvr/Ped Actn:				12	Obj Strk: 20			
17	105578074	1.539	08/14/2018 12:44	LEFT TURN, SAME ROADWAY	\$ 2000	0	0	0	1	1	1	2	1	0	13	
Unit	1 : 4	Alchl/Drugs:	0	Speed:	10 MPH	Dir:	N	Veh Mnvr/Ped Actn:				4	Obj Strk:			
Unit	2 : 3	Alchl/Drugs:	0	Speed:	10 MPH	Dir:	SE	Veh Mnvr/Ped Actn:				8	Obj Strk:			

**North Carolina Department of Transportation
Traffic Engineering Accident Analysis System
Strip Analysis Report**

Acc No	Crash ID	Milepost	Date	Accident Type	Total Damage	Injuries				Condition			Road		Trfc Ctl	
						F	A	B	C	R	L	W	Ch	Ci	Dv	Op
18	105585217	1.539	08/20/2018 10:35	SIDESWIPE, SAME DIRECTION	\$ 2700	0	0	0	0	1	1	1	3	0	3	1
Unit	1 : 4	Alchl/Drugs:	0	Speed:	20 MPH	Dir:	N	Veh Mnvr/Ped Actn:				4	Obj Strk:			
Unit	2 : 10	Alchl/Drugs:	0	Speed:	20 MPH	Dir:	N	Veh Mnvr/Ped Actn:				5	Obj Strk:			
19	105399729	1.540	02/16/2018 14:39	ANGLE	\$ 5000	0	0	0	0	1	1	1	2	0	0	2
Unit	1 : 1	Alchl/Drugs:	0	Speed:	10 MPH	Dir:	N	Veh Mnvr/Ped Actn:				8	Obj Strk:			
Unit	2 : 1	Alchl/Drugs:	0	Speed:	15 MPH	Dir:	S	Veh Mnvr/Ped Actn:				4	Obj Strk:			
20	104534816	1.556	10/23/2015 13:29	ANGLE	\$ 1300	0	0	0	0	1	1	1	1	0	3	1
Unit	1 : 1	Alchl/Drugs:	0	Speed:	10 MPH	Dir:	S	Veh Mnvr/Ped Actn:				5	Obj Strk:			
Unit	2 : 1	Alchl/Drugs:	0	Speed:	15 MPH	Dir:	S	Veh Mnvr/Ped Actn:				4	Obj Strk:			
21	105156327	1.556	06/29/2017 22:50	SIDESWIPE, SAME DIRECTION	\$ 2700	0	0	0	0	1	4	1	1	0		2
Unit	1 : 2	Alchl/Drugs:	0	Speed:	10 MPH	Dir:	S	Veh Mnvr/Ped Actn:				16	Obj Strk:			
Unit	2 : 1	Alchl/Drugs:	0	Speed:	10 MPH	Dir:	S	Veh Mnvr/Ped Actn:				4	Obj Strk:			
22	105931072	1.558	06/14/2019 17:46	REAR END, SLOW OR STOP	\$ 8000	0	0	0	2	1	1	1	1	0	3	2
Unit	1 : 1	Alchl/Drugs:	0	Speed:	30 MPH	Dir:	N	Veh Mnvr/Ped Actn:				4	Obj Strk:			
Unit	2 : 1	Alchl/Drugs:	0	Speed:	0 MPH	Dir:	N	Veh Mnvr/Ped Actn:				1	Obj Strk:			
23	105800704	1.561	03/02/2019 13:20	ANGLE	\$ 2000	0	0	0	0	1	1	1	1	0	3	1
Unit	1 : 1	Alchl/Drugs:	0	Speed:	5 MPH	Dir:	S	Veh Mnvr/Ped Actn:				4	Obj Strk:			
Unit	2 : 1	Alchl/Drugs:	0	Speed:	5 MPH	Dir:	S	Veh Mnvr/Ped Actn:				5	Obj Strk:			
24	106129994	1.561	12/15/2019 14:40	SIDESWIPE, SAME DIRECTION	\$ 5000	0	0	0	0	1	1	1	1	0	3	1
Unit	1 : 4	Alchl/Drugs:	0	Speed:	15 MPH	Dir:	N	Veh Mnvr/Ped Actn:				5	Obj Strk:			
Unit	2 : 1	Alchl/Drugs:	0	Speed:	15 MPH	Dir:	N	Veh Mnvr/Ped Actn:				4	Obj Strk:			
25	106175778	1.562	02/24/2020 07:41	PARKED MOTOR VEHICLE	\$ 3200	0	0	0	0	1	1	2	1	0		0
Unit	1 : 14	Alchl/Drugs:	7	Speed:	0 MPH	Dir:	S	Veh Mnvr/Ped Actn:				1	Obj Strk: 20			
Unit	2 : 1	Alchl/Drugs:	0	Speed:	10 MPH	Dir:	S	Veh Mnvr/Ped Actn:				4	Obj Strk: 20			
26	104724760	1.565	04/18/2016 14:06	LEFT TURN, SAME ROADWAY	\$ 2000	0	0	0	0	1	1	1	3	0	3	1
Unit	1 : 1	Alchl/Drugs:	0	Speed:	10 MPH	Dir:	S	Veh Mnvr/Ped Actn:				8	Obj Strk:			
Unit	2 : 1	Alchl/Drugs:	0	Speed:	0 MPH	Dir:	NW	Veh Mnvr/Ped Actn:				8	Obj Strk:			

**North Carolina Department of Transportation
Traffic Engineering Accident Analysis System
Strip Analysis Report**

Acc No	Crash ID	Milepost	Date	Accident Type	Total Damage	Injuries				Condition			Road		Trfc Ctl	
						F	A	B	C	R	L	W	Ch	Ci	Dv	Op
27	105271558	1.565	10/24/2017 09:41	REAR END, SLOW OR STOP	\$ 1800	0	0	0	0	1	1	2	1	0	3	1
Unit	1 : 4	Alchl/Drgs:	0	Speed: 15 MPH Dir: S		Veh Mnvr/Ped Actn:				4	Obj Strk:					
Unit	2 : 4	Alchl/Drgs:	0	Speed: 10 MPH Dir: S		Veh Mnvr/Ped Actn:				5	Obj Strk:					
28	105294540	1.565	11/07/2017 19:51	REAR END, SLOW OR STOP	\$ 1500	0	0	0	0	2	4	3	3	0		2
Unit	1 : 1	Alchl/Drgs:	0	Speed: 10 MPH Dir: S		Veh Mnvr/Ped Actn:				4	Obj Strk:					
Unit	2 : 1	Alchl/Drgs:	0	Speed: 0 MPH Dir: S		Veh Mnvr/Ped Actn:				11	Obj Strk:					
29	105286130	1.568	11/04/2017 16:11	REAR END, SLOW OR STOP	\$ 400	0	0	0	0	1	1	2	1	0	0	2
Unit	1 : 1	Alchl/Drgs:	0	Speed: 5 MPH Dir: N		Veh Mnvr/Ped Actn:				4	Obj Strk:					
Unit	2 : 1	Alchl/Drgs:	0	Speed: 0 MPH Dir: N		Veh Mnvr/Ped Actn:				1	Obj Strk:					
30	104355645	1.575	03/13/2015 21:00	ANGLE	\$ 6000	0	0	0	0	1	4	1	1	0	3	3
Unit	1 : 1	Alchl/Drgs:	7	Speed: 10 MPH Dir: E		Veh Mnvr/Ped Actn:				4	Obj Strk:					
Unit	2 : 32	Alchl/Drgs:	7	Speed: 30 MPH Dir: N		Veh Mnvr/Ped Actn:				4	Obj Strk:					
31	104364752	1.575	04/28/2015 16:51	RIGHT TURN, SAME ROADWAY	\$ 11500	0	0	0	0	1	1	1	1	0	3	1
Unit	1 : 1	Alchl/Drgs:	0	Speed: 10 MPH Dir: SW		Veh Mnvr/Ped Actn:				3	Obj Strk:					
Unit	2 : 1	Alchl/Drgs:	0	Speed: 15 MPH Dir: E		Veh Mnvr/Ped Actn:				4	Obj Strk:					
32	104458325	1.575	08/05/2015 09:05	SIDESWIPE, SAME DIRECTION	\$ 1100	0	0	0	0	1	1	1	1	0	3	1
Unit	1 : 12	Alchl/Drgs:	7	Speed: 0 MPH Dir: S		Veh Mnvr/Ped Actn:				3	Obj Strk:		20			
Unit	2 : 10	Alchl/Drgs:	0	Speed: 3 MPH Dir: S		Veh Mnvr/Ped Actn:				12	Obj Strk:					
33	104592789	1.575	11/14/2015 14:36	LEFT TURN, SAME ROADWAY	\$ 1200	0	0	0	0	1	1	1	1	0	3	1
Unit	1 : 6	Alchl/Drgs:	0	Speed: 5 MPH Dir: S		Veh Mnvr/Ped Actn:				8	Obj Strk:					
Unit	2 : 1	Alchl/Drgs:	0	Speed: 2 MPH Dir: N		Veh Mnvr/Ped Actn:				4	Obj Strk:					
34	104761803	1.575	05/16/2016 16:45	RIGHT TURN, SAME ROADWAY	\$ 4500	0	0	0	0	1	1	1	1	0	3	1
Unit	1 : 1	Alchl/Drgs:	0	Speed: 15 MPH Dir: E		Veh Mnvr/Ped Actn:				7	Obj Strk:					
Unit	2 : 6	Alchl/Drgs:	0	Speed: 20 MPH Dir: N		Veh Mnvr/Ped Actn:				4	Obj Strk:					
35	105011016	1.575	02/04/2017 18:24	ANGLE	\$ 1100	0	0	0	0	1	4	1	1	0	3	
Unit	1 : 1	Alchl/Drgs:	0	Speed: 15 MPH Dir: NE		Veh Mnvr/Ped Actn:				8	Obj Strk:					
Unit	2 : 1	Alchl/Drgs:	0	Speed: 0 MPH Dir: S		Veh Mnvr/Ped Actn:				1	Obj Strk:					

**North Carolina Department of Transportation
Traffic Engineering Accident Analysis System
Strip Analysis Report**

Acc No	Crash ID	Milepost	Date	Accident Type	Total Damage	Injuries				Condition			Road		Trfc Ctl	
						F	A	B	C	R	L	W	Ch	Ci	Dv	Op
36	105328702	1.575	12/05/2017 09:10	RIGHT TURN, DIFFERENT ROADWAYS	\$ 0	0	1	0	0	1	1	1	1	0	3	1
Unit	1 : 2	Alchl/Drugs:	0	Speed:	3 MPH Dir: E	Veh Mnvr/Ped Actn:				7	Obj Strk:		14			
Unit	2 : 24	Alchl/Drugs:	0	Speed:	0 MPH Dir:	Veh Mnvr/Ped Actn:					Obj Strk:		14			
37	105434861	1.575	03/20/2018 15:06	SIDESWIPE, SAME DIRECTION	\$ 2900	0	0	0	0	1	1	2		0		
Unit	1 : 7	Alchl/Drugs:	0	Speed:	0 MPH Dir: E	Veh Mnvr/Ped Actn:				4	Obj Strk:					
Unit	2 : 1	Alchl/Drugs:	0	Speed:	0 MPH Dir: E	Veh Mnvr/Ped Actn:				5	Obj Strk:					
38	105532154	1.575	06/29/2018 17:28	SIDESWIPE, SAME DIRECTION	\$ 1250	0	0	0	0	1	1	1	1	0	3	1
Unit	1 : 6	Alchl/Drugs:	0	Speed:	15 MPH Dir: S	Veh Mnvr/Ped Actn:				12	Obj Strk:					
Unit	2 : 1	Alchl/Drugs:	0	Speed:	5 MPH Dir: S	Veh Mnvr/Ped Actn:				7	Obj Strk:					
39	105653065	1.575	10/12/2018 15:44	LEFT TURN, DIFFERENT ROADWAYS	\$ 2000	0	0	0	0	1	1	1	1	0	3	1
Unit	1 : 1	Alchl/Drugs:	0	Speed:	10 MPH Dir: W	Veh Mnvr/Ped Actn:				8	Obj Strk:					
Unit	2 : 1	Alchl/Drugs:	0	Speed:	20 MPH Dir: E	Veh Mnvr/Ped Actn:				4	Obj Strk:					
40	105746585	1.575	12/31/2018 21:25	ANGLE	\$ 1600	0	0	0	0	2	4	2	3	0	3	1
Unit	1 : 1	Alchl/Drugs:	0	Speed:	15 MPH Dir: S	Veh Mnvr/Ped Actn:				4	Obj Strk:					
Unit	2 : 1	Alchl/Drugs:	0	Speed:	10 MPH Dir: E	Veh Mnvr/Ped Actn:				4	Obj Strk:					
41	105792934	1.575	02/23/2019 07:51	ANGLE	\$ 2150	0	0	0	0	2	1	3	1	0	3	1
Unit	1 : 1	Alchl/Drugs:	0	Speed:	25 MPH Dir: W	Veh Mnvr/Ped Actn:				4	Obj Strk:					
Unit	2 : 1	Alchl/Drugs:	0	Speed:	15 MPH Dir: N	Veh Mnvr/Ped Actn:				4	Obj Strk:					
42	105647287	1.580	10/05/2018 08:49	SIDESWIPE, SAME DIRECTION	\$ 5000	0	0	0	0	1	1	1	2	0	3	1
Unit	1 : 1	Alchl/Drugs:	0	Speed:	30 MPH Dir: SE	Veh Mnvr/Ped Actn:				4	Obj Strk:					
Unit	2 : 3	Alchl/Drugs:	0	Speed:	30 MPH Dir: SE	Veh Mnvr/Ped Actn:				5	Obj Strk:					
43	105339138	1.581	12/14/2017 19:04	SIDESWIPE, SAME DIRECTION	\$ 1500	0	0	0	0	1	4	1		0		
Unit	1 : 1	Alchl/Drugs:	0	Speed:	0 MPH Dir: S	Veh Mnvr/Ped Actn:				5	Obj Strk:					
Unit	2 : 1	Alchl/Drugs:	0	Speed:	0 MPH Dir: S	Veh Mnvr/Ped Actn:				1	Obj Strk:					
44	105045734	1.583	03/16/2017 14:05	RIGHT TURN, SAME ROADWAY	\$ 7000	0	0	0	0	1	1	1	2	0	3	1
Unit	1 : 16	Alchl/Drugs:	0	Speed:	30 MPH Dir: S	Veh Mnvr/Ped Actn:				7	Obj Strk:					
Unit	2 : 1	Alchl/Drugs:	0	Speed:	30 MPH Dir: S	Veh Mnvr/Ped Actn:				1	Obj Strk:					

**North Carolina Department of Transportation
Traffic Engineering Accident Analysis System
Strip Analysis Report**

Acc No	Crash ID	Milepost	Date	Accident Type	Total Damage	Injuries				Condition			Road		Trfc Ctl		
						F	A	B	C	R	L	W	Ch	Ci	Dv	Op	
45	104396203	1.600	05/27/2015 09:43	LEFT TURN, SAME ROADWAY	\$ 2000	0	0	1	0	1	1	1	3	0	3	1	
Unit	1 : 22	Alchl/Drgs:	0	Speed:	0 MPH	Dir:	Veh Mnvr/Ped Actn:				Obj Strk:						
Unit	2 : 4	Alchl/Drgs:	0	Speed:	0 MPH	Dir:	SE	Veh Mnvr/Ped Actn:				8	Obj Strk:				
46	104355983	1.605	04/08/2015 09:11	REAR END, SLOW OR STOP	\$ 200	0	0	1	0	1	1	1	2	0			
Unit	1 : 1	Alchl/Drgs:	0	Speed:	20 MPH	Dir:	N	Veh Mnvr/Ped Actn:				11	Obj Strk:				
Unit	2 : 21	Alchl/Drgs:	0	Speed:	0 MPH	Dir:		Veh Mnvr/Ped Actn:					Obj Strk:				
47	105078986	1.611	04/21/2017 10:39	LEFT TURN, SAME ROADWAY	\$ 8050	0	0	0	0	1	1	1	3	0	13	1	
Unit	1 : 1	Alchl/Drgs:	0	Speed:	20 MPH	Dir:	S	Veh Mnvr/Ped Actn:				4	Obj Strk:				
Unit	2 : 4	Alchl/Drgs:	0	Speed:	10 MPH	Dir:	S	Veh Mnvr/Ped Actn:				8	Obj Strk:				
48	104865088	1.652	09/05/2016 18:20	RAN OFF ROAD - RIGHT	\$ 3500	0	0	0	0	1	1	1	7	0	0		
Unit	1 : 4	Alchl/Drgs:	0	Speed:	40 MPH	Dir:	S	Veh Mnvr/Ped Actn:				4	Obj Strk: 34				
49	104355631	1.653	03/06/2015 16:33	SIDESWIPE, SAME DIRECTION	\$ 7000	0	0	0	0	1	1	1	7	0	0		
Unit	1 : 2	Alchl/Drgs:	0	Speed:	25 MPH	Dir:	N	Veh Mnvr/Ped Actn:				5	Obj Strk:				
Unit	2 : 1	Alchl/Drgs:	0	Speed:	25 MPH	Dir:	N	Veh Mnvr/Ped Actn:				4	Obj Strk:				
50	105886399	1.656	05/14/2019 16:00	SIDESWIPE, SAME DIRECTION	\$ 7000	0	0	0	1	1	1	1	6	0	0		
Unit	1 : 4	Alchl/Drgs:	0	Speed:	20 MPH	Dir:	S	Veh Mnvr/Ped Actn:				4	Obj Strk:				
Unit	2 : 1	Alchl/Drgs:	0	Speed:	25 MPH	Dir:	SE	Veh Mnvr/Ped Actn:				5	Obj Strk:				
51	105271555	1.657	04/12/2017 03:11	RAN OFF ROAD - RIGHT	\$ 20000	0	0	1	0	1	4	1	3	0			
Unit	1 : 1	Alchl/Drgs:	1	Speed:	35 MPH	Dir:	N	Veh Mnvr/Ped Actn:				4	Obj Strk: 18				
52	105603620	1.665	09/05/2018 08:49	REAR END, SLOW OR STOP	\$ 2500	0	0	0	0	1	1	1	6	0	1	1	
Unit	1 : 1	Alchl/Drgs:	0	Speed:	20 MPH	Dir:	S	Veh Mnvr/Ped Actn:				11	Obj Strk:				
Unit	2 : 4	Alchl/Drgs:	0	Speed:	25 MPH	Dir:	S	Veh Mnvr/Ped Actn:				11	Obj Strk:				
53	105904023	1.665	05/28/2019 14:38	HEAD ON	\$ 15800	0	0	0	1	1	1	1	7	0	13	1	
Unit	1 : 4	Alchl/Drgs:	0	Speed:	30 MPH	Dir:	S	Veh Mnvr/Ped Actn:				4	Obj Strk:				
Unit	2 : 1	Alchl/Drgs:	0	Speed:	25 MPH	Dir:	N	Veh Mnvr/Ped Actn:				4	Obj Strk:				
54	105359959	1.684	12/30/2017 22:43	RAN OFF ROAD - RIGHT	\$ 5300	0	0	0	0	1	4	1	7	0			
Unit	1 : 1	Alchl/Drgs:	1	Speed:	50 MPH	Dir:	N	Veh Mnvr/Ped Actn:				4	Obj Strk: 64				

**North Carolina Department of Transportation
Traffic Engineering Accident Analysis System
Strip Analysis Report**

Acc No	Crash ID	Milepost	Date	Accident Type	Total Damage	Injuries				Condition			Road		Trfc Ctl	
						F	A	B	C	R	L	W	Ch	Ci	Dv	Op
55	106042066	1.730	10/21/2019 15:11	REAR END, SLOW OR STOP	\$ 2000	0	0	0	0	1	1	1	1	0	14	1
Unit	1 : 1	Alchl/Drugs:	0	Speed: 25 MPH Dir: N		Veh Mnvr/Ped Actn:				11	Obj Strk:					
Unit	2 : 1	Alchl/Drugs:	0	Speed: 0 MPH Dir: N		Veh Mnvr/Ped Actn:				11	Obj Strk:					
56	104576019	1.750	11/09/2015 17:47	PEDESTRIAN	\$ 3000	0	0	1	0	2	4	3	3	0	14	1
Unit	1 : 1	Alchl/Drugs:	0	Speed: 40 MPH Dir: S		Veh Mnvr/Ped Actn:				4	Obj Strk:		14			
Unit	2 : 24	Alchl/Drugs:	0	Speed: 0 MPH Dir:		Veh Mnvr/Ped Actn:					Obj Strk:		14			
57	104945696	1.750	11/11/2016 17:40	REAR END, SLOW OR STOP	\$ 7000	0	0	0	1	1	1	1	3	0	14	1
Unit	1 : 4	Alchl/Drugs:	0	Speed: 0 MPH Dir: N		Veh Mnvr/Ped Actn:				11	Obj Strk:					
Unit	2 : 1	Alchl/Drugs:	0	Speed: 35 MPH Dir: N		Veh Mnvr/Ped Actn:				11	Obj Strk:					
58	105236012	1.750	09/21/2017 16:47	REAR END, SLOW OR STOP	\$ 10000	0	0	0	0	1	1	2	3	0	9	1
Unit	1 : 4	Alchl/Drugs:	0	Speed: 30 MPH Dir: S		Veh Mnvr/Ped Actn:				11	Obj Strk:					
Unit	2 : 1	Alchl/Drugs:	0	Speed: 35 MPH Dir: S		Veh Mnvr/Ped Actn:				11	Obj Strk:					
59	105310538	1.750	11/25/2017 16:23	RAN OFF ROAD - LEFT	\$ 8150	0	0	0	0	1	1	1	3	0	14	1
Unit	1 : 1	Alchl/Drugs:	0	Speed: 35 MPH Dir: N		Veh Mnvr/Ped Actn:				4	Obj Strk:		48			
60	105258315	1.837	10/05/2017 20:00	LEFT TURN, DIFFERENT ROADWAYS	\$ 5000	0	0	0	0	1	4	1	3	0	1	1
Unit	1 : 1	Alchl/Drugs:	0	Speed: 5 MPH Dir: NE		Veh Mnvr/Ped Actn:				8	Obj Strk:					
Unit	2 : 1	Alchl/Drugs:	0	Speed: 20 MPH Dir: S		Veh Mnvr/Ped Actn:				4	Obj Strk:					

Legend for Report Details:
 Acc No - Accident Number
 Injuries: F - Fatal, A - Class A, B - Class B, C - Class C
 Condition: R - Road Surface, L - Ambient Light, W - Weather
 Rd Ch - Road Character
 Rd Ci - Roadway Contributing Circumstances
 Trfc Ctl - Traffic Control: Dv - Device, Op - Operating
 Alchl/Drugs - Alcohol Drugs Suspected
 Veh Mnvr/Ped Actn - Vehicle Maneuver/Pedestrian Action
 Obj Strk - Object Struck

**North Carolina Department of Transportation
Traffic Engineering Accident Analysis System
Strip Analysis Report**

Summary Statistics

High Level Crash Summary

Crash Type	Number of Crashes	Percent of Total
Total Crashes	60	100.00
Fatal Crashes	0	0.00
Non-Fatal Injury Crashes	11	18.33
Total Injury Crashes	11	18.33
Property Damage Only Crashes	49	81.67
Night Crashes	16	26.67
Wet Crashes	10	16.67
Alcohol/Drugs Involvement Crashes	2	3.33

Crash Severity Summary

Crash Type	Number of Crashes	Percent of Total
Total Crashes	60	100.00
Fatal Crashes	0	0.00
Class A Crashes	1	1.67
Class B Crashes	5	8.33
Class C Crashes	5	8.33
Property Damage Only Crashes	49	81.67

Vehicle Exposure Statistics

Annual ADT = 17000

Total Length = 0.334 (Miles)

0.538 (Kilometers)

Total Vehicle Exposure = 10.37 (MVMT)

16.69 (MVKMT)

Crash Rate	Crashes Per 100 Million Vehicle Miles	Crashes Per 100 Million Vehicle Kilometers
Total Crash Rate	578.39	359.39
Fatal Crash Rate	0.00	0.00
Non Fatal Crash Rate	106.04	65.89
Night Crash Rate	154.24	95.84
Wet Crash Rate	96.40	59.90
EPDO Rate	2022.42	1256.67

**North Carolina Department of Transportation
Traffic Engineering Accident Analysis System
Strip Analysis Report**

Miscellaneous Statistics

Severity Index =	3.50
EPDO Crash Index =	209.80
Estimated Property Damage Total = \$	225800.00

Accident Type Summary

Accident Type	Number of Crashes	Percent of Total
ANGLE	7	11.67
BACKING UP	1	1.67
FIXED OBJECT	1	1.67
HEAD ON	1	1.67
LEFT TURN, DIFFERENT ROADWAYS	2	3.33
LEFT TURN, SAME ROADWAY	6	10.00
PARKED MOTOR VEHICLE	2	3.33
PEDALCYCLIST	1	1.67
PEDESTRIAN	1	1.67
RAN OFF ROAD - LEFT	1	1.67
RAN OFF ROAD - RIGHT	3	5.00
REAR END, SLOW OR STOP	13	21.67
REAR END, TURN	1	1.67
RIGHT TURN, DIFFERENT ROADWAYS	1	1.67
RIGHT TURN, SAME ROADWAY	5	8.33
SIDESWIPE, SAME DIRECTION	14	23.33

Injury Summary

Injury Type	Number of Injuries	Percent of Total
Fatal Injuries	0	0.00
Class A Injuries	1	8.33
Class B Injuries	5	41.67
Class C Injuries	6	50.00
Total Non-Fatal Injuries	12	100.00
Total Injuries	12	100.00

**North Carolina Department of Transportation
Traffic Engineering Accident Analysis System
Strip Analysis Report**

Monthly Summary

Month	Number of Crashes	Percent of Total
Jan	4	6.67
Feb	6	10.00
Mar	5	8.33
Apr	5	8.33
May	4	6.67
Jun	6	10.00
Jul	0	0.00
Aug	3	5.00
Sep	4	6.67
Oct	9	15.00
Nov	7	11.67
Dec	7	11.67

Daily Summary

Day	Number of Crashes	Percent of Total
Mon	11	18.33
Tue	11	18.33
Wed	6	10.00
Thu	9	15.00
Fri	13	21.67
Sat	8	13.33
Sun	2	3.33

**North Carolina Department of Transportation
Traffic Engineering Accident Analysis System
Strip Analysis Report**

Hourly Summary

Hour	Number of Crashes	Percent of Total
0000-0059	0	0.00
0100-0159	0	0.00
0200-0259	0	0.00
0300-0359	1	1.67
0400-0459	0	0.00
0500-0559	0	0.00
0600-0659	0	0.00
0700-0759	2	3.33
0800-0859	2	3.33
0900-0959	5	8.33
1000-1059	3	5.00
1100-1159	1	1.67
1200-1259	2	3.33
1300-1359	5	8.33
1400-1459	7	11.67
1500-1559	3	5.00
1600-1659	8	13.33
1700-1759	5	8.33
1800-1859	2	3.33
1900-1959	6	10.00
2000-2059	2	3.33
2100-2159	3	5.00
2200-2259	3	5.00
2300-2359	0	0.00

**North Carolina Department of Transportation
Traffic Engineering Accident Analysis System
Strip Analysis Report**

Light and Road Conditions Summary

Condition	Dry	Wet	Other	Total
Day	40	3	0	43
Dark	10	6	0	16
Other	0	1	0	1
Total	50	10	0	60

Object Struck Summary

Object Type	Times Struck	Percent of Total
MEDIAN BARRIER FACE	1	6.25
MOVABLE OBJECT	1	6.25
OTHER FIXED OBJECT	1	6.25
PARKED MOTOR VEHICLE	5	31.25
PEDALCYCLIST	2	12.50
PEDESTRIAN	4	25.00
UTILITY POLE	2	12.50

Vehicle Type Summary

Vehicle Type	Number Involved	Percent of Total
COMMERCIAL BUS	7	6.03
LIGHT TRUCK (MINI-VAN, PANEL)	2	1.72
MOPED	1	0.86
MOTOR SCOOTER OR MOTOR BIKE	1	0.86
PASSENGER CAR	65	56.03
PEDALCYCLE	1	0.86
PEDESTRIAN	2	1.72
PICKUP	8	6.90
POLICE	1	0.86
SCHOOL BUS	1	0.86
SINGLE UNIT TRUCK (2-AXLE, 6-TIRE)	2	1.72
SPORT UTILITY	18	15.52
TRACTOR/SEMI-TRAILER	1	0.86
TRUCK/TRAILER	1	0.86
UNKNOWN	3	2.59
UNKNOWN HEAVY TRUCK	1	0.86
VAN	1	0.86

**North Carolina Department of Transportation
Traffic Engineering Accident Analysis System
Strip Analysis Report**

Yearly Totals Summary

Accident Totals

Year	Total Accidents	Fatal Accidents	Injury Accidents	Property Damage Only Accidents
2015	10	0	3	7
2016	6	0	1	5
2017	17	0	3	14
2018	12	0	1	11
2019	13	0	3	10
2020	2	0	0	2
Total	60	0	11	49

Injury Totals

Year	Fatal Injuries	Class A, B, or C Injuries
2015	0	3
2016	0	1
2017	0	3
2018	0	1
2019	0	4
2020	0	0
Total	0	12

Miscellaneous Totals

Year	Property Damage	EPDO Index
2015	\$ 35900	32.20
2016	\$ 23850	13.40
2017	\$ 76250	107.60
2018	\$ 33550	19.40
2019	\$ 52050	35.20
2020	\$ 4200	2.00
Total	\$ 225800	209.80

Type of Accident Totals

Year	Left Turn	Right Turn	Rear End	Run Off Road &			
				Fixed Object	Angle	Side Swipe	Other
2015	2	1	2	0	2	2	1
2016	1	2	2	1	0	0	0

**North Carolina Department of Transportation
Traffic Engineering Accident Analysis System
Strip Analysis Report**

Year	Left Turn	Right Turn	Rear End	Run Off Road &		Angle	Side Swipe	Other
				Fixed Object				
2017	2	2	5	3		1	3	1
2018	3	0	1	0		2	5	1
2019	0	1	4	0		2	4	2
2020	0	0	0	1		0	0	1
Total	8	6	14	5		7	14	6

**North Carolina Department of Transportation
Traffic Engineering Accident Analysis System
Strip Analysis Report**

Strip Diagram

Features	Milepost	Crash IDs	
SR 1010 FRANKLIN	1.50	104638171 105258275 105277830 105621408 105762508 105924164 106093058 105137204	
	1.51	105924176 105784524	
	1.52	104953103 104633096 105765170	
	1.53	105730355 106175777 105366746	
	1.54	105578074 105585217 105399729	
	1.55		
	1.56	104534816 105156327 105931072 105800704 106129994 106175778	
	1.57	104724760 105271558 105294540 105286130	
	ROSEMARY	1.58	104355645 104364752 104458325 104592789 104761803 105011016 105328702 105434861 105532154 105653065 105746585 105792934 105647287 105339138 105045734
		1.59	
		1.60	104396203
		1.61	104355983 105078986
		1.62	
		1.63	
		1.64	
1.65		104865088 104355631	
COLUMBIA NORTH		1.66	105886399 105271555 105603620 105904023
		1.67	
	1.68	105359959	
	1.69		
	1.70		
	1.71		
	1.72		
	1.73	106042066	
	1.74		
	1.75	104576019 104945696 105236012 105310538	
1.76			
1.77			
1.78			
1.79			
1.80			
1.81			
1.82			
1.83			
STEPHEN	1.84	105258315	

**North Carolina Department of Transportation
Traffic Engineering Accident Analysis System
Strip Analysis Report**

Study Criteria

Study Name	Log No.	PH No.	TIP No.	K/A Cf.	B/C Cf.	ADT	ADT Route
ROSEMARYDECKTIANC86STRIPTJF				76.8	8.4	17000	30000086

Request Date	Courier Service	Phone No.	Ext.	Fax No.

County			Municipality						
Name	Code	Div.	Name	Code	Y-Line Ft.	Begin Date	End Date	Years	
ORANGE	68	7	All and Rural		0	3/1/2015	2/29/2020	5.00	

Location Text	Requestor
NC 86 (Martin Luther King Jr. Blvd/Columbia St) from SR 1010 (Franklin St) to Stephens St	

Included Accidents	Old MP	New MP	Type
105137204		1.505	I
106129994		1.561	I
105800704		1.561	I
105271555		1.657	I
104576019		1.75	I
105294540		1.565	I
105271558		1.565	I
105647287		1.58	I
104396203		1.6	I
104945696		1.75	I
105236012		1.75	I
105310538		1.75	I

Excluded Accidents
104355919
104413584
104459365
104644616
104644618
104654588
104915606
104986156
105307127
105318882
105373901
105383108

**North Carolina Department of Transportation
Traffic Engineering Accident Analysis System
Strip Analysis Report**

Excluded Accidents

105491232
105532135
105544869
105598098
105987043
106184244

Fiche Roads

Name	Code
NC 86	30000086
MARTIN LUTHER KING	50019060
COLUMBIA	50006670

Strip Road

Name	Code	Begin MP	End MP	Miles	Kilometers
NC 86	30000086	1.503	1.837	0.334	0.538

**North Carolina Department of Transportation
Traffic Engineering Accident Analysis System
Intersection Analysis Report**

Acc No	Crash ID	Date	Accident Type	Total Damage	Injuries				Condition			Road		Trfc Ctl	
					F	A	B	C	R	L	W	Ch	Ci	Dv	Op
9	105603620	09/05/2018 08:49	REAR END, SLOW OR STOP	\$ 2500	0	0	0	0	1	1	1	6	0	1	1
Unit	1 : 1	Alch/Drgs: 0	Speed: 20 MPH	Dir: S	Veh Mnvr / Ped Actn:				11	Obj Strk:					
Unit	2 : 4	Alch/Drgs: 0	Speed: 25 MPH	Dir: S	Veh Mnvr / Ped Actn:				11	Obj Strk:					

10	105886399	05/14/2019 16:00	SIDESWIPE, SAME DIRECTION	\$ 7000	0	0	0	1	1	1	1	6	0	0	
Unit	1 : 4	Alch/Drgs: 0	Speed: 20 MPH	Dir: S	Veh Mnvr / Ped Actn:				4	Obj Strk:					
Unit	2 : 1	Alch/Drgs: 0	Speed: 25 MPH	Dir: SE	Veh Mnvr / Ped Actn:				5	Obj Strk:					

11	105904023	05/28/2019 14:38	HEAD ON	\$ 15800	0	0	0	1	1	1	1	7	0	13	1
Unit	1 : 4	Alch/Drgs: 0	Speed: 30 MPH	Dir: S	Veh Mnvr / Ped Actn:				4	Obj Strk:					
Unit	2 : 1	Alch/Drgs: 0	Speed: 25 MPH	Dir: N	Veh Mnvr / Ped Actn:				4	Obj Strk:					

Legend for Report Details:
 Acc No - Accident Number
 Injuries: F - Fatal, A - Class A, B - Class B, C - Class C
 Condition: R - Road Surface, L - Ambient Light, W - Weather
 Rd Ch - Road Character
 Rd Ci - Roadway Contributing Circumstances
 Trfc Ctl - Traffic Control: Dv - Device, Op - Operating
 Alch/Drgs - Alcohol Drugs Suspected
 Veh Mnvr/Ped Actn - Vehicle Maneuver/Pedestrian Action
 Obj Strk - Object Struck

**North Carolina Department of Transportation
Traffic Engineering Accident Analysis System
Intersection Analysis Report**

Summary Statistics

High Level Crash Summary

Crash Type	Number of Crashes	Percent of Total
Total Crashes	11	100.00
Fatal Crashes	0	0.00
Non-Fatal Injury Crashes	4	36.36
Total Injury Crashes	4	36.36
Property Damage Only Crashes	7	63.64
Night Crashes	2	18.18
Wet Crashes	0	0.00
Alcohol/Drugs Involvement Crashes	2	18.18

Crash Severity Summary

Crash Type	Number of Crashes	Percent of Total
Total Crashes	11	100.00
Fatal Crashes	0	0.00
Class A Crashes	0	0.00
Class B Crashes	1	9.09
Class C Crashes	3	27.27
Property Damage Only Crashes	7	63.64

Vehicle Exposure Statistics

Annual ADT = 19000

Total Vehicle Exposure = 34.71 (MEV)

Crash Rate	Crashes Per 100 Million Vehicles Entered
Total Crash Rate	31.69
Fatal Crash Rate	0.00
Non Fatal Crash Rate	11.52
Night Crash Rate	5.76
Wet Crash Rate	0.00
EPDO Rate	116.96

**North Carolina Department of Transportation
Traffic Engineering Accident Analysis System
Intersection Analysis Report**

Miscellaneous Statistics

Severity Index =	3.69
EPDO Crash Index =	40.60
Estimated Property Damage Total = \$	74301.00

Accident Type Summary

Accident Type	Number of Crashes	Percent of Total
ANGLE	1	9.09
HEAD ON	1	9.09
RAN OFF ROAD - RIGHT	3	27.27
REAR END, SLOW OR STOP	4	36.36
SIDESWIPE, SAME DIRECTION	2	18.18

Injury Summary

Injury Type	Number of Injuries	Percent of Total
Fatal Injuries	0	0.00
Class A Injuries	0	0.00
Class B Injuries	1	25.00
Class C Injuries	3	75.00
Total Non-Fatal Injuries	4	100.00
Total Injuries	4	100.00

**North Carolina Department of Transportation
Traffic Engineering Accident Analysis System
Intersection Analysis Report**

Monthly Summary

Month	Number of Crashes	Percent of Total
Jan	0	0.00
Feb	0	0.00
Mar	1	9.09
Apr	1	9.09
May	2	18.18
Jun	1	9.09
Jul	2	18.18
Aug	0	0.00
Sep	2	18.18
Oct	0	0.00
Nov	0	0.00
Dec	2	18.18

Daily Summary

Day	Number of Crashes	Percent of Total
Mon	1	9.09
Tue	3	27.27
Wed	4	36.36
Thu	0	0.00
Fri	1	9.09
Sat	1	9.09
Sun	1	9.09

**North Carolina Department of Transportation
Traffic Engineering Accident Analysis System
Intersection Analysis Report**

Hourly Summary

Hour	Number of Crashes	Percent of Total
0000-0059	0	0.00
0100-0159	0	0.00
0200-0259	0	0.00
0300-0359	1	9.09
0400-0459	0	0.00
0500-0559	0	0.00
0600-0659	0	0.00
0700-0759	1	9.09
0800-0859	1	9.09
0900-0959	0	0.00
1000-1059	0	0.00
1100-1159	0	0.00
1200-1259	1	9.09
1300-1359	0	0.00
1400-1459	2	18.18
1500-1559	0	0.00
1600-1659	3	27.27
1700-1759	0	0.00
1800-1859	1	9.09
1900-1959	0	0.00
2000-2059	0	0.00
2100-2159	0	0.00
2200-2259	1	9.09
2300-2359	0	0.00

**North Carolina Department of Transportation
Traffic Engineering Accident Analysis System
Intersection Analysis Report**

Light and Road Conditions Summary

Condition	Dry	Wet	Other	Total
Day	9	0	0	9
Dark	2	0	0	2
Other	0	0	0	0
Total	11	0	0	11

Object Struck Summary

Object Type	Times Struck	Percent of Total
MOVABLE OBJECT	1	33.33
OTHER FIXED OBJECT	1	33.33
UTILITY POLE	1	33.33

Vehicle Type Summary

Vehicle Type	Number Involved	Percent of Total
PASSENGER CAR	10	52.63
PICKUP	2	10.53
SPORT UTILITY	7	36.84

**North Carolina Department of Transportation
Traffic Engineering Accident Analysis System
Intersection Analysis Report**

Yearly Totals Summary

Accident Totals

Year	Total Accidents	Fatal Accidents	Injury Accidents	Property Damage Only Accidents
2015	2	0	0	2
2016	1	0	0	1
2017	4	0	2	2
2018	2	0	0	2
2019	2	0	2	0
2020	0	0	0	0
Total	11	0	4	7

Injury Totals

Year	Fatal Injuries	Class A, B, or C Injuries
2015	0	0
2016	0	0
2017	0	2
2018	0	0
2019	0	2
2020	0	0
Total	0	4

Miscellaneous Totals

Year	Property Damage	EPDO Index
2015	\$ 11000	2.00
2016	\$ 3500	1.00
2017	\$ 33000	18.80
2018	\$ 4001	2.00
2019	\$ 22800	16.80
2020	\$ 0	0.00
Total	\$ 74301	40.60

Type of Accident Totals

Year	Left Turn	Right Turn	Rear End	Run Off Road &				Other
				Fixed Object	Angle	Side Swipe		
2015	0	0	1	0	0	1	0	
2016	0	0	0	1	0	0	0	

**North Carolina Department of Transportation
Traffic Engineering Accident Analysis System
Intersection Analysis Report**

Year	Run Off Road &						
	Left Turn	Right Turn	Rear End	Fixed Object	Angle	Side Swipe	Other
2017	0	0	1	2	1	0	0
2018	0	0	2	0	0	0	0
2019	0	0	0	0	0	1	1
2020	0	0	0	0	0	0	0
Total	0	0	4	3	1	2	1

**North Carolina Department of Transportation
Traffic Engineering Accident Analysis System
Intersection Analysis Report**

Study Criteria

Study Name	Log No.	PH No.	TIP No.	K/A Cf.	B/C Cf.	ADT	ADT Route
ROSEMARYDECKTIAINT1TJF				76.8	8.4	19000	

Request Date	Courier Service	Phone No.	Ext.	Fax No.

County			Municipality			Y-Line Ft.	Begin Date	End Date	Years
Name	Code	Div.	Name	Code					
ORANGE	68	7	All and Rural		150	3/1/2015	2/29/2020	5.00	

Location Text	Requestor
NC 86 (Martin Luther King Blvd) at Columbia St/North St	

Included Accidents
105550231

Excluded Accidents
105383108

Fiche Roads

Name	Code
NC 86	30000086
MARTIN LUTHER KING	50019060
COLUMBIA	50006670
NORTH	50021532

Intersection Road Combinations

Name	Code	Code	Name
NC 86	30000086	50006670	COLUMBIA
NC 86	30000086	50021532	NORTH
MARTIN LUTHER KING	50019060	50006670	COLUMBIA
MARTIN LUTHER KING	50019060	50021532	NORTH
COLUMBIA	50006670	50021532	NORTH

**North Carolina Department of Transportation
Traffic Engineering Accident Analysis System
Intersection Analysis Report**

Acc No	Crash ID	Date	Accident Type	Total Damage	Injuries				Condition			Road		Trfc Ctl	
					F	A	B	C	R	L	W	Ch	Ci	Dv	Op
Unit	2 : 4	Alchl/Drgs: 0	Speed: 0 MPH Dir: W	Veh Mnvr / Ped Actn:	3	Obj Strk:									
Unit	3 : 4	Alchl/Drgs: 0	Speed: 0 MPH Dir: W	Veh Mnvr / Ped Actn:	3	Obj Strk:									
9	104724760	04/18/2016 14:06	LEFT TURN, SAME ROADWAY	\$ 2000	0	0	0	0	1	1	1	3	0	3	1
Unit	1 : 1	Alchl/Drgs: 0	Speed: 10 MPH Dir: S	Veh Mnvr / Ped Actn:	8	Obj Strk:									
Unit	2 : 1	Alchl/Drgs: 0	Speed: 0 MPH Dir: NW	Veh Mnvr / Ped Actn:	8	Obj Strk:									
10	104761803	05/16/2016 16:45	RIGHT TURN, SAME ROADWAY	\$ 4500	0	0	0	0	1	1	1	1	0	3	1
Unit	1 : 1	Alchl/Drgs: 0	Speed: 15 MPH Dir: E	Veh Mnvr / Ped Actn:	7	Obj Strk:									
Unit	2 : 6	Alchl/Drgs: 0	Speed: 20 MPH Dir: N	Veh Mnvr / Ped Actn:	4	Obj Strk:									
11	104915606	10/28/2016 18:25	SIDESWIPE, OPPOSITE DIRECTION	\$ 1000	0	0	0	0	1	1	1	1	0	3	1
Unit	1 : 12	Alchl/Drgs: 0	Speed: 5 MPH Dir: S	Veh Mnvr / Ped Actn:	8	Obj Strk:									
Unit	2 : 1	Alchl/Drgs: 0	Speed: 0 MPH Dir: E	Veh Mnvr / Ped Actn:	1	Obj Strk:									
12	105011016	02/04/2017 18:24	ANGLE	\$ 1100	0	0	0	0	1	4	1	1	0	3	
Unit	1 : 1	Alchl/Drgs: 0	Speed: 15 MPH Dir: NE	Veh Mnvr / Ped Actn:	8	Obj Strk:									
Unit	2 : 1	Alchl/Drgs: 0	Speed: 0 MPH Dir: S	Veh Mnvr / Ped Actn:	1	Obj Strk:									
13	105045734	03/16/2017 14:05	RIGHT TURN, SAME ROADWAY	\$ 7000	0	0	0	0	1	1	1	2	0	3	1
Unit	1 : 16	Alchl/Drgs: 0	Speed: 30 MPH Dir: S	Veh Mnvr / Ped Actn:	7	Obj Strk:									
Unit	2 : 1	Alchl/Drgs: 0	Speed: 30 MPH Dir: S	Veh Mnvr / Ped Actn:	1	Obj Strk:									
14	105076551	04/10/2017 14:46	REAR END, SLOW OR STOP	\$ 1500	0	0	0	0	1	1	1	1	0	3	1
Unit	1 : 1	Alchl/Drgs: 0	Speed: 5 MPH Dir: E	Veh Mnvr / Ped Actn:	12	Obj Strk:									
Unit	2 : 4	Alchl/Drgs: 0	Speed: 0 MPH Dir: E	Veh Mnvr / Ped Actn:	1	Obj Strk:									
15	105095484	05/04/2017 09:04	REAR END, SLOW OR STOP	\$ 1200	0	0	0	0	1	1	1	1	0	3	2
Unit	1 : 1	Alchl/Drgs: 0	Speed: 0 MPH Dir: E	Veh Mnvr / Ped Actn:	1	Obj Strk:									
Unit	2 : 1	Alchl/Drgs: 0	Speed: 5 MPH Dir: E	Veh Mnvr / Ped Actn:	12	Obj Strk:									
16	105142349	06/20/2017 13:41	REAR END, SLOW OR STOP	\$ 1900	0	0	0	0	1	1	1	3	0	3	1
Unit	1 : 2	Alchl/Drgs: 0	Speed: 20 MPH Dir: W	Veh Mnvr / Ped Actn:	1	Obj Strk:									
Unit	2 : 1	Alchl/Drgs: 0	Speed: 20 MPH Dir: W	Veh Mnvr / Ped Actn:	4	Obj Strk:									
17	105156327	06/29/2017 22:50	SIDESWIPE, SAME DIRECTION	\$ 2700	0	0	0	0	1	4	1	1	0		2
Unit	1 : 2	Alchl/Drgs: 0	Speed: 10 MPH Dir: S	Veh Mnvr / Ped Actn:	16	Obj Strk:									

**North Carolina Department of Transportation
Traffic Engineering Accident Analysis System
Intersection Analysis Report**

Acc No	Crash ID	Date	Accident Type	Total Damage	Injuries				Condition			Road		Trfc Ctl	
					F	A	B	C	R	L	W	Ch	Ci	Dv	Op
Unit	2 : 1	Alchl/Drgs: 0	Speed: 10 MPH Dir: S		Veh Mnvr / Ped Actn: 4				Obj Strk:						
18	105187671	08/06/2017 15:22	REAR END, SLOW OR STOP	\$ 300	0	0	0	4	1	1	1	1	0	3	1
Unit	1 : 1	Alchl/Drgs: 0	Speed: 0 MPH Dir: E		Veh Mnvr / Ped Actn: 11				Obj Strk:						
Unit	2 : 1	Alchl/Drgs: 0	Speed: 5 MPH Dir: E		Veh Mnvr / Ped Actn: 12				Obj Strk:						
19	105217658	09/05/2017 19:19	LEFT TURN, SAME ROADWAY	\$ 1500	0	0	0	0	1	1	1	1	0	3	1
Unit	1 : 1	Alchl/Drgs: 0	Speed: 10 MPH Dir: SW		Veh Mnvr / Ped Actn: 12				Obj Strk:						
Unit	2 : 1	Alchl/Drgs: 0	Speed: 25 MPH Dir: SW		Veh Mnvr / Ped Actn: 4				Obj Strk:						
20	105271558	10/24/2017 09:41	REAR END, SLOW OR STOP	\$ 1800	0	0	0	0	1	1	2	1	0	3	1
Unit	1 : 4	Alchl/Drgs: 0	Speed: 15 MPH Dir: S		Veh Mnvr / Ped Actn: 4				Obj Strk:						
Unit	2 : 4	Alchl/Drgs: 0	Speed: 10 MPH Dir: S		Veh Mnvr / Ped Actn: 5				Obj Strk:						
21	105286130	11/04/2017 16:11	REAR END, SLOW OR STOP	\$ 400	0	0	0	0	1	1	2	1	0	0	2
Unit	1 : 1	Alchl/Drgs: 0	Speed: 5 MPH Dir: N		Veh Mnvr / Ped Actn: 4				Obj Strk:						
Unit	2 : 1	Alchl/Drgs: 0	Speed: 0 MPH Dir: N		Veh Mnvr / Ped Actn: 1				Obj Strk:						
22	105294540	11/07/2017 19:51	REAR END, SLOW OR STOP	\$ 1500	0	0	0	0	2	4	3	3	0		2
Unit	1 : 1	Alchl/Drgs: 0	Speed: 10 MPH Dir: S		Veh Mnvr / Ped Actn: 4				Obj Strk:						
Unit	2 : 1	Alchl/Drgs: 0	Speed: 0 MPH Dir: S		Veh Mnvr / Ped Actn: 11				Obj Strk:						
23	105319155	12/01/2017 10:47	REAR END, SLOW OR STOP	\$ 2500	0	0	0	0	1	1	1	3	0	3	1
Unit	1 : 1	Alchl/Drgs: 0	Speed: 20 MPH Dir: W		Veh Mnvr / Ped Actn: 1				Obj Strk:						
Unit	2 : 4	Alchl/Drgs: 0	Speed: 20 MPH Dir: W		Veh Mnvr / Ped Actn: 4				Obj Strk:						
24	105328702	12/05/2017 09:10	RIGHT TURN, DIFFERENT ROADWAYS	\$ 0	0	1	0	0	1	1	1	1	0	3	1
Unit	1 : 2	Alchl/Drgs: 0	Speed: 3 MPH Dir: E		Veh Mnvr / Ped Actn: 7				Obj Strk:			14			
Unit	2 : 24	Alchl/Drgs: 0	Speed: 0 MPH Dir:		Veh Mnvr / Ped Actn:				Obj Strk:			14			
25	105339138	12/14/2017 19:04	SIDESWIPE, SAME DIRECTION	\$ 1500	0	0	0	0	1	4	1		0		
Unit	1 : 1	Alchl/Drgs: 0	Speed: 0 MPH Dir: S		Veh Mnvr / Ped Actn: 5				Obj Strk:						
Unit	2 : 1	Alchl/Drgs: 0	Speed: 0 MPH Dir: S		Veh Mnvr / Ped Actn: 1				Obj Strk:						
26	105373901	01/16/2018 17:10	REAR END, SLOW OR STOP	\$ 2000	0	0	0	0	1	2	1		0		
Unit	1 : 1	Alchl/Drgs: 0	Speed: 0 MPH Dir: W		Veh Mnvr / Ped Actn: 1				Obj Strk:						
Unit	2 : 1	Alchl/Drgs: 0	Speed: 0 MPH Dir: W		Veh Mnvr / Ped Actn: 4				Obj Strk:						

**North Carolina Department of Transportation
Traffic Engineering Accident Analysis System
Intersection Analysis Report**

Acc No	Crash ID	Date	Accident Type	Total Damage	Injuries				Condition			Road		Trfc Ctl	
					F	A	B	C	R	L	W	Ch	Ci	Dv	Op
27	105434861	03/20/2018 15:06	SIDESWIPE, SAME DIRECTION	\$ 2900	0	0	0	0	1	1	2	0			
Unit	1 : 7	Alchl/Drugs: 0	Speed: 0 MPH Dir: E	Veh Mnvr / Ped Actn: 4					4				Obj Strk:		
Unit	2 : 1	Alchl/Drugs: 0	Speed: 0 MPH Dir: E	Veh Mnvr / Ped Actn: 5					5				Obj Strk:		
28	105491232	05/20/2018 21:53	LEFT TURN, SAME ROADWAY	\$ 6000	0	0	0	0	1	3	1	1	0	3	1
Unit	1 : 1	Alchl/Drugs: 0	Speed: 15 MPH Dir: E	Veh Mnvr / Ped Actn: 8					8				Obj Strk:		
Unit	2 : 1	Alchl/Drugs: 0	Speed: 20 MPH Dir: W	Veh Mnvr / Ped Actn: 4					4				Obj Strk:		
29	105532154	06/29/2018 17:28	SIDESWIPE, SAME DIRECTION	\$ 1250	0	0	0	0	1	1	1	1	0	3	1
Unit	1 : 6	Alchl/Drugs: 0	Speed: 15 MPH Dir: S	Veh Mnvr / Ped Actn: 12					12				Obj Strk:		
Unit	2 : 1	Alchl/Drugs: 0	Speed: 5 MPH Dir: S	Veh Mnvr / Ped Actn: 7					7				Obj Strk:		
30	105544869	07/12/2018 10:28	REAR END, SLOW OR STOP	\$ 1000	0	0	0	0	1	1	1	1	0	3	2
Unit	1 : 1	Alchl/Drugs: 0	Speed: 5 MPH Dir: W	Veh Mnvr / Ped Actn: 11					11				Obj Strk:		
Unit	2 : 1	Alchl/Drugs: 0	Speed: 0 MPH Dir: W	Veh Mnvr / Ped Actn: 11					11				Obj Strk:		
31	105598098	07/31/2018 11:15	BACKING UP	\$ 1000	0	0	0	0	10	1	9	1	0	3	3
Unit	1 : 2	Alchl/Drugs: 7	Speed: 10 MPH Dir: W	Veh Mnvr / Ped Actn: 10					10				Obj Strk:		
Unit	2 : 1	Alchl/Drugs: 0	Speed: 0 MPH Dir: E	Veh Mnvr / Ped Actn: 1					1				Obj Strk:		
32	105647287	10/05/2018 08:49	SIDESWIPE, SAME DIRECTION	\$ 5000	0	0	0	0	1	1	1	2	0	3	1
Unit	1 : 1	Alchl/Drugs: 0	Speed: 30 MPH Dir: SE	Veh Mnvr / Ped Actn: 4					4				Obj Strk:		
Unit	2 : 3	Alchl/Drugs: 0	Speed: 30 MPH Dir: SE	Veh Mnvr / Ped Actn: 5					5				Obj Strk:		
33	105653065	10/12/2018 15:44	LEFT TURN, DIFFERENT ROADWAYS	\$ 2000	0	0	0	0	1	1	1	1	0	3	1
Unit	1 : 1	Alchl/Drugs: 0	Speed: 10 MPH Dir: W	Veh Mnvr / Ped Actn: 8					8				Obj Strk:		
Unit	2 : 1	Alchl/Drugs: 0	Speed: 20 MPH Dir: E	Veh Mnvr / Ped Actn: 4					4				Obj Strk:		
34	105748774	12/29/2018 23:49	HEAD ON	\$ 9000	0	0	0	0	1	4	1	2	0	3	1
Unit	1 : 4	Alchl/Drugs: 1	Speed: 30 MPH Dir: E	Veh Mnvr / Ped Actn: 6					6				Obj Strk:		
Unit	2 : 2	Alchl/Drugs: 0	Speed: 0 MPH Dir: W	Veh Mnvr / Ped Actn: 1					1				Obj Strk:		
Unit	3 : 1	Alchl/Drugs: 0	Speed: 20 MPH Dir: E	Veh Mnvr / Ped Actn: 4					4				Obj Strk:		
35	105746585	12/31/2018 21:25	ANGLE	\$ 1600	0	0	0	0	2	4	2	3	0	3	1
Unit	1 : 1	Alchl/Drugs: 0	Speed: 15 MPH Dir: S	Veh Mnvr / Ped Actn: 4					4				Obj Strk:		
Unit	2 : 1	Alchl/Drugs: 0	Speed: 10 MPH Dir: E	Veh Mnvr / Ped Actn: 4					4				Obj Strk:		

**North Carolina Department of Transportation
Traffic Engineering Accident Analysis System
Intersection Analysis Report**

Acc No	Crash ID	Date	Accident Type	Total Damage	Injuries				Condition			Road		Trfc Ctl	
					F	A	B	C	R	L	W	Ch	Ci	Dv	Op
36	105792934	02/23/2019 07:51	ANGLE	\$ 2150	0	0	0	0	2	1	3	1	0	3	1
Unit	1 : 1	Alchl/Drugs: 0	Speed: 25 MPH Dir: W	Veh Mnvr / Ped Actn: 4					Obj Strk:						
Unit	2 : 1	Alchl/Drugs: 0	Speed: 15 MPH Dir: N	Veh Mnvr / Ped Actn: 4					Obj Strk:						
37	105800704	03/02/2019 13:20	ANGLE	\$ 2000	0	0	0	0	1	1	1	1	0	3	1
Unit	1 : 1	Alchl/Drugs: 0	Speed: 5 MPH Dir: S	Veh Mnvr / Ped Actn: 4					Obj Strk:						
Unit	2 : 1	Alchl/Drugs: 0	Speed: 5 MPH Dir: S	Veh Mnvr / Ped Actn: 5					Obj Strk:						
38	105800967	03/10/2019 00:02	PEDESTRIAN	\$ 0	0	0	1	0	1	4	2	1	12	3	1
Unit	1 : 32	Alchl/Drugs: 7	Speed: 5 MPH Dir: N	Veh Mnvr / Ped Actn: 8					Obj Strk:						
Unit	2 : 24	Alchl/Drugs: 2	Speed: 0 MPH Dir:	Veh Mnvr / Ped Actn:					Obj Strk:						
39	105824361	03/25/2019 16:44	REAR END, SLOW OR STOP	\$ 1100	0	0	0	0	2	1	3	1	0	3	2
Unit	1 : 1	Alchl/Drugs: 0	Speed: 0 MPH Dir: E	Veh Mnvr / Ped Actn: 1					Obj Strk:						
Unit	2 : 1	Alchl/Drugs: 0	Speed: 5 MPH Dir: E	Veh Mnvr / Ped Actn: 4					Obj Strk:						
40	105931072	06/14/2019 17:46	REAR END, SLOW OR STOP	\$ 8000	0	0	0	2	1	1	1	1	0	3	2
Unit	1 : 1	Alchl/Drugs: 0	Speed: 30 MPH Dir: N	Veh Mnvr / Ped Actn: 4					Obj Strk:						
Unit	2 : 1	Alchl/Drugs: 0	Speed: 0 MPH Dir: N	Veh Mnvr / Ped Actn: 1					Obj Strk:						
41	106129994	12/15/2019 14:40	SIDESWIPE, SAME DIRECTION	\$ 5000	0	0	0	0	1	1	1	1	0	3	1
Unit	1 : 4	Alchl/Drugs: 0	Speed: 15 MPH Dir: N	Veh Mnvr / Ped Actn: 5					Obj Strk:						
Unit	2 : 1	Alchl/Drugs: 0	Speed: 15 MPH Dir: N	Veh Mnvr / Ped Actn: 4					Obj Strk:						
42	106175778	02/24/2020 07:41	PARKED MOTOR VEHICLE	\$ 3200	0	0	0	0	1	1	2	1	0	0	
Unit	1 : 14	Alchl/Drugs: 7	Speed: 0 MPH Dir: S	Veh Mnvr / Ped Actn: 1					Obj Strk: 20						
Unit	2 : 1	Alchl/Drugs: 0	Speed: 10 MPH Dir: S	Veh Mnvr / Ped Actn: 4					Obj Strk: 20						

Legend for Report Details:
 Acc No - Accident Number
 Injuries: F - Fatal, A - Class A, B - Class B, C - Class C
 Condition: R - Road Surface, L - Ambient Light, W - Weather
 Rd Ch - Road Character
 Rd Ci - Roadway Contributing Circumstances
 Trfc Ctl - Traffic Control: Dv - Device, Op - Operating
 Alchl/Drugs - Alcohol Drugs Suspected
 Veh Mnvr/Ped Actn - Vehicle Maneuver/Pedestrian Action
 Obj Strk - Object Struck

**North Carolina Department of Transportation
Traffic Engineering Accident Analysis System
Intersection Analysis Report**

Summary Statistics

High Level Crash Summary

Crash Type	Number of Crashes	Percent of Total
Total Crashes	42	100.00
Fatal Crashes	0	0.00
Non-Fatal Injury Crashes	5	11.90
Total Injury Crashes	5	11.90
Property Damage Only Crashes	37	88.10
Night Crashes	9	21.43
Wet Crashes	4	9.52
Alcohol/Drugs Involvement Crashes	2	4.76

Crash Severity Summary

Crash Type	Number of Crashes	Percent of Total
Total Crashes	42	100.00
Fatal Crashes	0	0.00
Class A Crashes	1	2.38
Class B Crashes	2	4.76
Class C Crashes	2	4.76
Property Damage Only Crashes	37	88.10

Vehicle Exposure Statistics

Annual ADT = 24500

Total Vehicle Exposure = 44.76 (MEV)

Crash Rate	Crashes Per 100 Million Vehicles Entered
Total Crash Rate	93.83
Fatal Crash Rate	0.00
Non Fatal Crash Rate	11.17
Night Crash Rate	20.11
Wet Crash Rate	8.94
EPDO Rate	329.30

**North Carolina Department of Transportation
Traffic Engineering Accident Analysis System
Intersection Analysis Report**

Miscellaneous Statistics

Severity Index =	3.51
EPDO Crash Index =	147.40
Estimated Property Damage Total = \$	120650.00

Accident Type Summary

Accident Type	Number of Crashes	Percent of Total
ANGLE	6	14.29
BACKING UP	1	2.38
HEAD ON	1	2.38
LEFT TURN, DIFFERENT ROADWAYS	1	2.38
LEFT TURN, SAME ROADWAY	5	11.90
PARKED MOTOR VEHICLE	1	2.38
PEDESTRIAN	1	2.38
REAR END, SLOW OR STOP	14	33.33
RIGHT TURN, DIFFERENT ROADWAYS	1	2.38
RIGHT TURN, SAME ROADWAY	3	7.14
SIDESWIPE, OPPOSITE DIRECTION	1	2.38
SIDESWIPE, SAME DIRECTION	7	16.67

Injury Summary

Injury Type	Number of Injuries	Percent of Total
Fatal Injuries	0	0.00
Class A Injuries	1	11.11
Class B Injuries	2	22.22
Class C Injuries	6	66.67
Total Non-Fatal Injuries	9	100.00
Total Injuries	9	100.00

**North Carolina Department of Transportation
Traffic Engineering Accident Analysis System
Intersection Analysis Report**

Monthly Summary

Month	Number of Crashes	Percent of Total
Jan	2	4.76
Feb	3	7.14
Mar	6	14.29
Apr	3	7.14
May	4	9.52
Jun	4	9.52
Jul	2	4.76
Aug	2	4.76
Sep	1	2.38
Oct	6	14.29
Nov	3	7.14
Dec	6	14.29

Daily Summary

Day	Number of Crashes	Percent of Total
Mon	7	16.67
Tue	9	21.43
Wed	2	4.76
Thu	6	14.29
Fri	8	19.05
Sat	6	14.29
Sun	4	9.52

**North Carolina Department of Transportation
Traffic Engineering Accident Analysis System
Intersection Analysis Report**

Hourly Summary

Hour	Number of Crashes	Percent of Total
0000-0059	1	2.38
0100-0159	0	0.00
0200-0259	0	0.00
0300-0359	0	0.00
0400-0459	0	0.00
0500-0559	0	0.00
0600-0659	0	0.00
0700-0759	2	4.76
0800-0859	1	2.38
0900-0959	5	11.90
1000-1059	2	4.76
1100-1159	1	2.38
1200-1259	0	0.00
1300-1359	3	7.14
1400-1459	6	14.29
1500-1559	3	7.14
1600-1659	4	9.52
1700-1759	3	7.14
1800-1859	2	4.76
1900-1959	3	7.14
2000-2059	0	0.00
2100-2159	3	7.14
2200-2259	1	2.38
2300-2359	2	4.76

**North Carolina Department of Transportation
Traffic Engineering Accident Analysis System
Intersection Analysis Report**

Light and Road Conditions Summary

Condition	Dry	Wet	Other	Total
Day	28	2	1	31
Dark	7	2	0	9
Other	2	0	0	2
Total	37	4	1	42

Object Struck Summary

Object Type	Times Struck	Percent of Total
PARKED MOTOR VEHICLE	3	60.00
PEDESTRIAN	2	40.00

Vehicle Type Summary

Vehicle Type	Number Involved	Percent of Total
COMMERCIAL BUS	3	3.49
LIGHT TRUCK (MINI-VAN, PANEL)	1	1.16
MOTOR SCOOTER OR MOTOR BIKE	1	1.16
PASSENGER CAR	56	65.12
PEDESTRIAN	2	2.33
PICKUP	5	5.81
SCHOOL BUS	1	1.16
SINGLE UNIT TRUCK (2-AXLE, 6-TIRE)	1	1.16
SPORT UTILITY	10	11.63
TRACTOR/SEMI-TRAILER	1	1.16
TRUCK/TRAILER	2	2.33
UNKNOWN	2	2.33
UNKNOWN HEAVY TRUCK	1	1.16

**North Carolina Department of Transportation
Traffic Engineering Accident Analysis System
Intersection Analysis Report**

Yearly Totals Summary

Accident Totals

Year	Total Accidents	Fatal Accidents	Injury Accidents	Property Damage Only Accidents
2015	7	0	1	6
2016	4	0	0	4
2017	14	0	2	12
2018	10	0	0	10
2019	6	0	2	4
2020	1	0	0	1
Total	42	0	5	37

Injury Totals

Year	Fatal Injuries	Class A, B, or C Injuries
2015	0	1
2016	0	0
2017	0	5
2018	0	0
2019	0	3
2020	0	0
Total	0	9

Miscellaneous Totals

Year	Property Damage	EPDO Index
2015	\$ 25850	14.40
2016	\$ 16700	4.00
2017	\$ 24900	97.20
2018	\$ 31750	10.00
2019	\$ 18250	20.80
2020	\$ 3200	1.00
Total	\$ 120650	147.40

Type of Accident Totals

Year	Left Turn	Right Turn	Rear End	Run Off Road &			
				Fixed Object	Angle	Side Swipe	Other
2015	2	1	1	0	2	1	0
2016	1	1	1	0	0	1	0

**North Carolina Department of Transportation
Traffic Engineering Accident Analysis System
Intersection Analysis Report**

Year	Run Off Road &						
	Left Turn	Right Turn	Rear End	Fixed Object	Angle	Side Swipe	Other
2017	1	2	8	0	1	2	0
2018	2	0	2	0	1	3	2
2019	0	0	2	0	2	1	1
2020	0	0	0	0	0	0	1
Total	6	4	14	0	6	8	4

**North Carolina Department of Transportation
Traffic Engineering Accident Analysis System
Intersection Analysis Report**

Study Criteria

Study Name	Log No.	PH No.	TIP No.	K/A Cf.	B/C Cf.	ADT	ADT Route
ROSEMARYDECKTIAINT2TJF				76.8	8.4	24500	

Request Date	Courier Service	Phone No.	Ext.	Fax No.

County			Municipality			Y-Line Ft.	Begin Date	End Date	Years
Name	Code	Div.	Name	Code					
ORANGE	68	7	All and Rural		150	3/1/2015	2/29/2020	5.00	

Location Text	Requestor
NC 86 (N. Columbia St) at Rosemary St	

Included Accidents
105800967
106129994
105800704
105931072
104396203

Excluded Accidents
104644616

Fiche Roads

Name	Code
NC 86	30000086
COLUMBIA	50006670
ROSEMARY	50026492

Intersection Road Combinations

Name	Code	Code	Name
NC 86	30000086	50026492	ROSEMARY
COLUMBIA	50006670	50026492	ROSEMARY

**North Carolina Department of Transportation
Traffic Engineering Accident Analysis System
Intersection Analysis Report**

Acc No	Crash ID	Date	Accident Type	Total Damage	Injuries				Condition			Road		Trfc Ctl	
					F	A	B	C	R	L	W	Ch	Ci	Dv	Op
Unit	2 : 1	Alchl/Drgs: 7	Speed: 0 MPH Dir: N	Veh Mnvr / Ped Actn:	2	Obj Strk:									
9	106001910	09/15/2019 19:03	REAR END, SLOW OR STOP	\$ 2500	0	0	0	0	1	1	1	1	0	3	1
Unit	1 : 1	Alchl/Drgs: 0	Speed: 0 MPH Dir: N	Veh Mnvr / Ped Actn:	1	Obj Strk:									
Unit	2 : 1	Alchl/Drgs: 0	Speed: 10 MPH Dir: N	Veh Mnvr / Ped Actn:	4	Obj Strk:									
10	106040397	10/17/2019 17:00	LEFT TURN, SAME ROADWAY	\$ 10500	0	0	0	1	1	1	1	1	0	3	1
Unit	1 : 2	Alchl/Drgs: 0	Speed: 10 MPH Dir: SW	Veh Mnvr / Ped Actn:	8	Obj Strk:									
Unit	2 : 1	Alchl/Drgs: 0	Speed: 20 MPH Dir: NE	Veh Mnvr / Ped Actn:	4	Obj Strk:									
11	106151668	01/04/2020 18:36	REAR END, SLOW OR STOP	\$ 4000	0	0	0	0	2	4	2	1	0	3	1
Unit	1 : 1	Alchl/Drgs: 0	Speed: 20 MPH Dir: NE	Veh Mnvr / Ped Actn:	4	Obj Strk:									
Unit	2 : 4	Alchl/Drgs: 0	Speed: 5 MPH Dir: NE	Veh Mnvr / Ped Actn:	11	Obj Strk:									

Legend for Report Details:
 Acc No - Accident Number
 Injuries: F - Fatal, A - Class A, B - Class B, C - Class C
 Condition: R - Road Surface, L - Ambient Light, W - Weather
 Rd Ch - Road Character
 Rd Ci - Roadway Contributing Circumstances
 Trfc Ctl - Traffic Control: Dv - Device, Op - Operating
 Alchl/Drgs - Alcohol Drugs Suspected
 Veh Mnvr/Ped Actn - Vehicle Maneuver/Pedestrian Action
 Obj Strk - Object Struck

**North Carolina Department of Transportation
Traffic Engineering Accident Analysis System
Intersection Analysis Report**

Summary Statistics

High Level Crash Summary

Crash Type	Number of Crashes	Percent of Total
Total Crashes	11	100.00
Fatal Crashes	0	0.00
Non-Fatal Injury Crashes	1	9.09
Total Injury Crashes	1	9.09
Property Damage Only Crashes	10	90.91
Night Crashes	3	27.27
Wet Crashes	2	18.18
Alcohol/Drugs Involvement Crashes	0	0.00

Crash Severity Summary

Crash Type	Number of Crashes	Percent of Total
Total Crashes	11	100.00
Fatal Crashes	0	0.00
Class A Crashes	0	0.00
Class B Crashes	0	0.00
Class C Crashes	1	9.09
Property Damage Only Crashes	10	90.91

Vehicle Exposure Statistics

Annual ADT = 8500

Total Vehicle Exposure = 15.53 (MEV)

Crash Rate	Crashes Per 100 Million Vehicles Entered
Total Crash Rate	70.83
Fatal Crash Rate	0.00
Non Fatal Crash Rate	6.44
Night Crash Rate	19.32
Wet Crash Rate	12.88
EPDO Rate	118.48

**North Carolina Department of Transportation
Traffic Engineering Accident Analysis System
Intersection Analysis Report**

Miscellaneous Statistics

Severity Index =	1.67
EPDO Crash Index =	18.40
Estimated Property Damage Total = \$	42900.00

Accident Type Summary

Accident Type	Number of Crashes	Percent of Total
ANGLE	3	27.27
BACKING UP	1	9.09
LEFT TURN, DIFFERENT ROADWAYS	1	9.09
LEFT TURN, SAME ROADWAY	1	9.09
PARKED MOTOR VEHICLE	1	9.09
REAR END, SLOW OR STOP	4	36.36

Injury Summary

Injury Type	Number of Injuries	Percent of Total
Fatal Injuries	0	0.00
Class A Injuries	0	0.00
Class B Injuries	0	0.00
Class C Injuries	1	100.00
Total Non-Fatal Injuries	1	100.00
Total Injuries	1	100.00

**North Carolina Department of Transportation
Traffic Engineering Accident Analysis System
Intersection Analysis Report**

Monthly Summary

Month	Number of Crashes	Percent of Total
Jan	1	9.09
Feb	0	0.00
Mar	0	0.00
Apr	1	9.09
May	2	18.18
Jun	2	18.18
Jul	0	0.00
Aug	1	9.09
Sep	2	18.18
Oct	1	9.09
Nov	0	0.00
Dec	1	9.09

Daily Summary

Day	Number of Crashes	Percent of Total
Mon	2	18.18
Tue	0	0.00
Wed	1	9.09
Thu	3	27.27
Fri	1	9.09
Sat	2	18.18
Sun	2	18.18

**North Carolina Department of Transportation
Traffic Engineering Accident Analysis System
Intersection Analysis Report**

Hourly Summary

Hour	Number of Crashes	Percent of Total
0000-0059	0	0.00
0100-0159	0	0.00
0200-0259	0	0.00
0300-0359	0	0.00
0400-0459	0	0.00
0500-0559	0	0.00
0600-0659	0	0.00
0700-0759	0	0.00
0800-0859	0	0.00
0900-0959	0	0.00
1000-1059	0	0.00
1100-1159	0	0.00
1200-1259	1	9.09
1300-1359	0	0.00
1400-1459	0	0.00
1500-1559	2	18.18
1600-1659	3	27.27
1700-1759	1	9.09
1800-1859	2	18.18
1900-1959	1	9.09
2000-2059	0	0.00
2100-2159	0	0.00
2200-2259	0	0.00
2300-2359	1	9.09

**North Carolina Department of Transportation
Traffic Engineering Accident Analysis System
Intersection Analysis Report**

Light and Road Conditions Summary

Condition	Dry	Wet	Other	Total
Day	8	0	0	8
Dark	1	2	0	3
Other	0	0	0	0
Total	9	2	0	11

Object Struck Summary

Object Type	Times Struck	Percent of Total
PARKED MOTOR VEHICLE	2	100.00

Vehicle Type Summary

Vehicle Type	Number Involved	Percent of Total
PASSENGER CAR	15	68.18
PICKUP	1	4.55
SCHOOL BUS	1	4.55
SPORT UTILITY	4	18.18
UNKNOWN	1	4.55

**North Carolina Department of Transportation
Traffic Engineering Accident Analysis System
Intersection Analysis Report**

Yearly Totals Summary

Accident Totals

Year	Total Accidents	Fatal Accidents	Injury Accidents	Property Damage Only Accidents
2015	2	0	0	2
2016	0	0	0	0
2017	4	0	0	4
2018	1	0	0	1
2019	3	0	1	2
2020	1	0	0	1
Total	11	0	1	10

Injury Totals

Year	Fatal Injuries	Class A, B, or C Injuries
2015	0	0
2016	0	0
2017	0	0
2018	0	0
2019	0	1
2020	0	0
Total	0	1

Miscellaneous Totals

Year	Property Damage	EPDO Index
2015	\$ 6100	2.00
2016	\$ 0	0.00
2017	\$ 17100	4.00
2018	\$ 1700	1.00
2019	\$ 14000	10.40
2020	\$ 4000	1.00
Total	\$ 42900	18.40

Type of Accident Totals

Year	Left Turn	Right Turn	Rear End	Run Off Road &			
				Fixed Object	Angle	Side Swipe	Other
2015	1	0	0	0	1	0	0
2016	0	0	0	0	0	0	0

**North Carolina Department of Transportation
Traffic Engineering Accident Analysis System
Intersection Analysis Report**

Year	Run Off Road &						
	Left Turn	Right Turn	Rear End	Fixed Object	Angle	Side Swipe	Other
2017	0	0	1	0	1	0	2
2018	0	0	0	0	1	0	0
2019	1	0	2	0	0	0	0
2020	0	0	1	0	0	0	0
Total	2	0	4	0	3	0	2

**North Carolina Department of Transportation
Traffic Engineering Accident Analysis System
Intersection Analysis Report**

Study Criteria

Study Name	Log No.	PH No.	TIP No.	K/A Cf.	B/C Cf.	ADT	ADT Route
ROSEMARYDECKTIAINT3TJF				76.8	8.4	8500	

Request Date	Courier Service	Phone No.	Ext.	Fax No.

County			Municipality			Y-Line Ft.	Begin Date	End Date	Years
Name	Code	Div.	Name	Code					
ORANGE	68	7	All and Rural		150	3/1/2015	2/29/2020	5.00	

Location Text	Requestor
Rosemary St at Henderson St	

Fiche Roads

Name	Code
ROSEMARY	50026492
HENDERSON	50013670

Intersection Road Combinations

Name	Code	Code	Name
HENDERSON	50013670	50026492	ROSEMARY